

Engineering Sciences

1 '77

Branch Library

DISPERSION IN THE WAKE OF A MODEL
INDUSTRIAL COMPLEX

by

R. V. Hatcher
R. N. Meroney
J. A. Peterka
K. Kothari

Prepared for

Site Safety Research Branch
Office of Nuclear Regulatory Research
U.S. Nuclear Regulatory Commission
Washington, D.C. 20555

Fluid Dynamics and Diffusion Laboratory
Department of Civil Engineering
Colorado State University
Fort Collins, Colorado 80523



U18401 0074572

June 1977

CER76-77RVH-RNM-JAP-KK35

ABSTRACT

DISPERSION IN THE WAKE OF A MODEL INDUSTRIAL COMPLEX

1:200 scale models of the EOCR reactor building and surrounding silo and tank buildings at the National Reactor Testing Station, Idaho Falls, Idaho were put into the Meteorological Wind Tunnel at Colorado State University for the purpose of studying the effect of building wakes on dispersion. Flow visualization was done and concentration measurements were taken. The test program consisted of systematic releases from ground, building height, and stack height sources with no appreciable plume rise. The program was repeated for cases of moderately unstable, neutral, moderately stable, and stable conditions in the wind tunnel.

Results show that the buildings significantly alter the dispersion patterns and the addition of any extra buildings or slight terrain change in the immediate vicinity of the building has a major effect. In the near wake region the effects of stratification were still evident causing slightly higher concentrations for stable conditions and slightly lower for unstable. Current dispersion models are discussed and evaluated that predict concentrations in the building wake region. A simple volume source model was found to predict reasonably well ground level concentrations. No model was found to accurately predict concentrations from elevated sources. In agreement with earlier studies the major effect of the buildings was to enhance the dispersion in both the horizontal and vertical for ground level releases while elevated releases enhanced only the vertical.

ACKNOWLEDGMENTS

This study was performed under Contract No. AT(49-24)-0236 with the United States Nuclear Regulatory Commission. Financial assistance received is gratefully acknowledged. The guidance of Dr. Robert Abbey, Jr. NRC, in coordinating this effort with the field program at the Idaho National Engineering Laboratory was essential to the completion of this program.

TABLE OF CONTENTS

<u>Chapter</u>	<u>Page</u>
ABSTRACT	iii
ACKNOWLEDGMENTS	v
LIST OF FIGURES	viii
LIST OF TABLES	xii
LIST OF SYMBOLS	xiii
1 INTRODUCTION AND LITERATURE REVIEW	1
1.1 Introduction	1
1.2 Review of Flow and Diffusion in Building Wakes	2
2 SIMILARITY CRITERIA	10
2.1 Simulation of Background Flow	10
2.2 Simulation of Flow around the Building	14
2.3 Simulation of Concentrations	15
3 EXPERIMENTAL APPARATUS AND MEASUREMENT TECHNIQUE	17
3.1 Wind Tunnel	17
3.2 Velocity Measurements	17
3.3 Temperature Measurements	18
3.4 Smoke Visualization Technique	18
3.5 Oil Film Technique	18
3.6 Sampling System	19
3.7 Gas Chromatography Technique	19
3.8 Model	20
3.9 Tunnel Configuration	20
3.10 Concentration Measurement Technique	21
3.11 Data Reduction	22
3.12 Experimental Procedure	22
4 EXPERIMENTAL RESULTS AND DISCUSSION	23
4.1 Test Program	23
4.2 Characteristics of the Background Flow	24
4.3 Flow Visualization	27
4.3.1 Oil Film Technique	27
4.3.2 Smoke Visualization	28
4.3.2.1 Ground Level Release	28
4.3.2.2 Building Height Release	29
4.3.2.3 Stack Height Release	29
4.3.2.4 Stratification Effect on Plume Dispersion near the Building	29
4.4 Concentration Measurements	30
4.4.1 $x/h_B > 15$ with Buildings Present	32
4.4.2 $x/h_B < 15$ with Buildings Present	33
4.4.3 Diffusion Isopleths	34

<u>Chapter</u>		<u>Page</u>
4.5	Comparison	35
	4.5.1 Discussion of Models	35
	4.5.2 Comparison with Observed Data	39
4.6	Correlation of Wind Tunnel Measurements to Field Measurements	39
5	CONCLUSIONS	42
	REFERENCES	44
	FIGURES	47
	TABLES	117

LIST OF FIGURES

<u>Figure</u>		<u>Page</u>
1	Values of σ_z for NRTS, Idaho Falls, Idaho (from Yansky, 1966)	48
2	Values of σ_y for NRTS, Idaho Falls, Idaho (from Yansky, 1966)	48
3	Flow fields past a cube (from Halitsky, 1968)	49
4	Flow pattern past a cube (from Woo, 1976)	50
5	Variation of Monin-Obukhov length L with bulk Richardson number	51
6	Meteorological Wind Tunnel	52
7	Velocity profile, slightly unstable stratification	53
8	Velocity profile, neutral stratification	54
9	Velocity profile, slightly stable stratification	55
10	Velocity profile, strongly stable stratification	56
11	Temperature profiles	57
12	Tracer Gas Sampling and Analysis System	58
13	Model	59
14	Sketch of building orientation and terrain	60
15	Spires	61
16	Sampling grid	62
17	Centerline velocity defects, $\theta = 0^\circ$	63
18	Decay of mean velocity defect and turbulent intensity excess	64
19	Comparison of velocity profiles with similarity theory	65
20	Oil film pictures with silo and tank buildings present	66
21	Oil film pictures without silo and tank buildings present	68

<u>Figure</u>		<u>Page</u>
22a	Ground level release smoke visualization, neutral	70
22b	Ground level release smoke visualization, stable	72
23a	Building height release smoke visualization, neutral	74
23b	Building height release smoke visualization, stable	76
24a	Stack height release smoke visualization, neutral	78
24b	Stack height release smoke visualization, stable	80
25	Nondimensional vertical plume spread vs. distance downstream	82
26	Nondimensional lateral plume spread vs. distance downstream	83
27	Comparison of models with data, no buildings present	84
28a	$\ln \bar{\chi} \bar{U} A / Q$ vs. $\ln x / h_B$ with buildings present $\theta = 0^\circ$, neutral	85
28b	$\ln \bar{\chi} \bar{U} A / Q$ vs. $\ln x / h_B$ with buildings present $\theta = 45^\circ$, neutral	86
28c	$\ln \bar{\chi} \bar{U} A / Q$ vs. $\ln x / h_B$ with buildings present $\theta = 90^\circ$, neutral	87
28d	$\ln \bar{\chi} \bar{U} A / Q$ vs. $\ln x / h_B$ with buildings present $\theta = 135^\circ$, neutral	88
28e	$\ln \bar{\chi} \bar{U} A / Q$ vs. $\ln x / h_B$ with buildings present $\theta = 180^\circ$, neutral	89
28f	$\ln \bar{\chi} \bar{U} A / Q$ vs. $\ln x / h_B$ with buildings present $\theta = 225^\circ$, neutral	90
28g	$\ln \bar{\chi} \bar{U} A / Q$ vs. $\ln x / h_B$ with buildings present $\theta = 270^\circ$, neutral	91
28h	$\ln \bar{\chi} \bar{U} A / Q$ vs. $\ln x / h_B$ with buildings present $\theta = 315^\circ$, neutral	92

<u>Figure</u>		<u>Page</u>
29a	$\ln \chi \bar{U}A/Q$ vs. $\ln x/h_B$ with buildings present $\theta = 0^\circ$, slightly unstable	93
29b	$\ln \chi \bar{U}A/Q$ vs. $\ln x/h_B$ with buildings present $\theta = 0^\circ$, strongly stable	94
30	Polar diagram of K_{\max} as measured at 87 m vs. wind approach angle for ground level release	95
31	Polar diagram of K_{\max} as measured at 1200 m vs. wind approach angle for ground level release	96
32	Polar diagram of K_{\max} as measured at 87 m vs. wind approach angle for building height release	97
33	Polar diagram of K_{\max} as measured at 1200 m vs. wind approach angle for building height release	98
34	Polar diagram of K_{\max} as measured at 87 m vs. wind approach angle for stack height release	99
35	Polar diagram of K_{\max} as measured at 1200 m vs. wind approach angle for stack height release	100
36	Diffusion isopleths, $\theta = 135^\circ$, slightly unstable, ground release	101
37	Diffusion isopleths, ground level x-y plane neutral, ground release, $\theta = 135^\circ$	102
38	Diffusion isopleths, $\theta = 135^\circ$, slightly stable, ground release	103
39	Diffusion isopleths, $\theta = 135^\circ$, strongly stable, ground release	104
40	Diffusion isopleths, $\theta = 315^\circ$, neutral, stack release	105
41	Diffusion isopleths, vertical x-z plane neutral, stack release, $\theta = 315^\circ$	106
42	Diffusion isopleths, vertical x-z plane strongly stable, stack release, $\theta = 315^\circ$	107
43	Diffusion isopleths, $\theta = 0^\circ$, slightly unstable, building height release	108
44	Diffusion isopleths, $\theta = 0^\circ$, neutral, building height release	109

<u>Figure</u>		<u>Page</u>
45	Diffusion isopleths, $\theta = 0^\circ$, slightly stable, building height release	110
46	Diffusion isopleths, $\theta = 0^\circ$, strongly stable, building height release	111
47	Diffusion isopleths, $\theta = 315^\circ$, slightly unstable, ground release	112
48	Diffusion isopleths, $\theta = 315^\circ$, neutral, ground release	113
49	Diffusion isopleths, $\theta = 315^\circ$, slightly stable, ground release	114
50	Diffusion isopleths, $\theta = 315^\circ$, strongly stable, ground release	115
51	Comparison of observed data with prediction equations	116

LIST OF TABLES

<u>Table</u>		<u>Page</u>
I	Comparison of Modeling Parameters for Model and Prototype	118
II	Key	119
III	Data, Slightly Unstable	120
IV	Data, Neutral	148
V	Data, Slightly Stable	176
VI	Data, Stable	204

LIST OF SYMBOLS

<u>Symbol</u>	<u>Meaning</u>
A	reference area
C	constant $\frac{1}{2} \leq C \leq 2$
C'	calibration coefficient
C_p	specific heat at constant pressure
E	output of integrating digital voltmeter (millivolt-seconds)
g	acceleration due to gravity
H	heat flux
h_s	height of stack
h_B	height of building
k	von Karman's constant $k = 0.35$
K_c	nondimensional concentration coefficient
L	Monin-Obukhov length = $-\frac{u_*^3 C_p \rho T}{kgH}$
p	power-law exponent
Q	source strength flow rate
R_y	lateral plume spread (by Halitsky)
R_z	vertical plume spread (by Halitsky)
t	time
T	temperature
u, v, w	components of mean velocity in x, y, and z directions
U_∞	free stream velocity
u_*	friction velocity = $\sqrt{\tau/\rho}$
V_s	stack velocity

<u>Symbol</u>	<u>Meaning</u>
x, y, z	a right-handed coordinate system where x downwind distance y crosswind distance z vertical distance
Z_o	roughness length

Greek Letters

α	ratio of eddy diffusivities K_h/K_m
β	constant of the log-linear law
δ	momentum boundary layer thickness
δ_T	thermal boundary layer thickness
ζ	z/L
α'	constant
θ	building orientation, measured from north
σ_y	standard deviation of the lateral plume spread
σ_z	standard deviation of the vertical plume spread
τ	shear stress
ρ	density
χ	local concentration

Chapter 1

INTRODUCTION AND LITERATURE REVIEW

1.1 Introduction

Both routine and inadvertent releases of hazardous materials or contaminants may occur at industrial sites. For example small releases of radioactivity are made when a buildup occurs in the working area of a nuclear reactor complex. The nuclear reactor plant itself is usually enclosed within a protective shell which is intended to prevent the accidental release of radioactive pollutants into the atmosphere. However should a crack or leak develop in the shell large amounts of radioactivity could be released. This study deals with the fate of contaminants released into the atmosphere under a variety of release situations.

1:200 scale models of the EOCR reactor building and surrounding silo and tank buildings at the Idaho National Engineering Laboratory, Idaho Falls, Idaho were put into the Meteorological Wind Tunnel at Colorado State University. Flow visualization used titanium-tetrachloride as a visible tracer gas. Concentration measurements were accomplished using ethane and propane as tracer gases, and gas chromatography techniques. The test program consisted of systematic releases from the base on the northwest face, center rooftop and the stack. In each case the release rate was maintained at low rates such that no appreciable jetting or plume rise was present. The program was repeated for cases of moderately unstable, neutral, moderately stable, and stable conditions in the wind tunnel.

This experiment is part of a joint wind tunnel field investigation of diffusion in the wake of the EOCR building. It is expected that through a comparison of the results of these studies an important

contribution can be made as to the validity of wind tunnel measurements of diffusion.

The remaining sections of this chapter discuss the relevant past experiments on flow and diffusion in building wakes. Chapter 2 reviews modeling requirements for simulating atmospheric motions and diffusion in the wind tunnel. The third chapter discusses the apparatus and various techniques used in performing the experiment. Chapter 4 presents the test program and important results. Finally, Chapter 5 discusses the conclusions that can be drawn from this study.

1.2 Review of Flow and Diffusion in Building Wakes

For sources on or in the cavity-wake region near a building the conventional Gaussian diffusion formulas tend to be highly conservative. These formulas were derived under the assumption of homogeneous, isotropic turbulence, and streamlines that are parallel to each other and to the ground. None of the above assumptions are valid in the cavity-wake region; thus, it is not surprising then that the diffusion formulas cannot adequately predict concentrations in such situations.

To handle the effects of a diabatic surface layer Pasquill (later modified by Gifford) has arrived at semi-empirical formulas and a family of curves that relate the standard deviation of the plume width, in both the y and z directions to six stability categories. These categories range from extremely unstable to moderately stable conditions and are functions of insolation, surface wind speed and cloud cover. In evaluating values of σ_y and σ_z with distance no provisions were made for surface roughness affects. Despite this fact the Pasquill-Gifford values of σ_y and σ_z correlate reasonably well with field measurements in open, flat terrain. Other

methods are also available that predict σ_z and σ_y from lapse rate and standard deviation of the wind variation.

The Pasquill-Gifford curves as used in this report (see Slade, 1968) are by no means universal. Markee (as cited by Yansky et al., 1966) derived a set of curves from diffusion experiments at the Idaho National Engineering Laboratory, Idaho Falls, Idaho. These curves are presented in Figures 1 and 2. Unlike Pasquill's curves it should be noted that the values of σ_y in the stable categories increase with increasing stability. This represents the contribution of horizontal plume meander under stable conditions for flat, desert-like terrain.

Because of the failure of simple algorithms to predict concentrations in the wake of a building complex, most predictions of dilution in the area near buildings are performed by experiments in low turbulence wind tunnels. The results are then extrapolated to full-scale. This extrapolation process is not without unavoidable error due to the wind tunnel's inability to model such things as meandering and large-scale eddies.

In the atmosphere generally two types of turbulence are present. Aerodynamic turbulence is caused by the introduction of obstacles into the flow. Buildings, trees, grass, rocks, etc. all produce changes in the velocity and pressure fields and the turbulence generated is generally considered of aerodynamic origin. This type of turbulence is also called mechanical turbulence. Aerodynamic turbulence, a micro-scale phenomenon, is the result of shearing forces acting between layers of air as they move past an obstacle and are accelerated. Atmospheric turbulence results from vertical and horizontal temperature gradients in a diabatic surface layer.

Halitsky (1968) describes the flow near a sharp-edged building. The background flow is defined as where the streamlines remain straight and parallel and assumption of isotropic, homogeneous turbulence are valid. The region that is directly affected by the building is called the aerodynamically distorted region.

Aerodynamic distortion has three regions: displacement zone, wake and cavity* as shown in Figure 3. The wake and cavity regions are the direct result of separation. The displacement zone is the region of air motion that has been affected by the presence of the building. The wake and cavity region result from an adverse pressure gradient from the upstream to downstream face of the building. As the flow approaches the building a stagnation zone of high pressure builds on the upstream face and the air is displaced over and around the building. The pressure becomes negative near the roof and side edges. As a result of the positive pressure gradient just downwind of the leading edge the flow separates from the building. Depending on the dimensions of the building the flow may or may not reattach. The properties of the boundary layer at the upwind face determine the structure of the separated region.

The boundary of the wake region behind the building is difficult to locate. Momentum diffuses into the wake and sets the fluid in motion. As a result sharp velocity discontinuities are not usually present. The air at the top of the cavity region moves downwind and a resulting return flow at the surface is generated (Figure 3). Two

*Not to be confused with the term "cavity" used in the hydraulic sense to mean where the liquid has undergone a change of phase due to a low static pressure.

zones may be identified in the wake. The uppermost zone is where the flow moves downstream continuously. Just below is a closed zone where the air recirculates, or moves upwind, this zone is called the cavity. At some distance downwind the aerodynamic turbulence dies out and the streamlines become straight and parallel again.

The cavity region, for two-dimensional obstacles or buildings with large aspect ratio (height to width ratio), is marked by the presence of large stationary vortices which are usually about the size of the building. In the cavity large velocity defects, high turbulence intensity and strong mixing are present (Peterka and Cermak, 1975). The vortices in the cavity are strongly a function of building orientation. Slight changes in wind direction can cause an entirely new vortex configuration in the wake.

When an obstacle is two-dimensional, a recirculating flow develops in the cavity region. Transport between this region and the surrounding flow field is by turbulent diffusion. For a finite length obstacle (i.e., a building) air parcels traveling along upwind streamlines may enter directly into the cavity region (see Figure 4) and depart as circulation about the horseshoe-shaped vortices wrapped around the obstacle face. Thus, the sketch of the cavity streamlines as noted by Halitsky (Figure 3) must be modified in light of newer data (Woo et al., 1976).

Birkhoff (1957) performed a study of cavities and wakes behind a series of obstacles. He showed that the wake region is approximately paraboloidal downstream of the obstacle, and was virtually independent of obstacle shape. The cavity, on the other hand, was determined by the shape of the obstacle since the upstream boundary of the cavity is the obstacle itself.

Sherlock (1940, 1941) performed both wind tunnel and full-scale field studies. The earlier study was directed to locate positions of relatively low concentrations such that ventilators could be installed that would not inhale contaminants from a nearby stack. The latter study was to determine ground level concentrations of sulphur dioxide from short stacks. A compromise was reached to minimize concentrations that involved both stack height and efflux velocity.

Wind tunnel studies of diffusion that have been verified by full-scale measurements are relatively rare. Martin (1965) performed both a wind tunnel and field study of the Ford Nuclear Reactor site at the University of Michigan. The wind tunnel data correlated well with average field concentrations within 250 feet of the source and winds greater than eight miles per hour. When the wind speed was less than eight miles per hour peak field concentrations were best correlated with the wind tunnel data. Peak to mean concentrations for downwind distances greater than 250 feet were found to be a function of the horizontal component of gustiness. Martin also compared the wind tunnel concentrations to those predicted by Sutton's equation and found the wind tunnel results to be more accurate.

Kalinske et al. (1945) conducted tests of diffusion from a continuous area source in a city in a wind tunnel at the Iowa Institute of Hydraulic Research. Horizontal and vertical concentrations among downwind buildings were measured. A method was developed to correlate peak field measurements to average concentrations in the wind tunnel. With the proper choice of coefficients very close agreement was achieved.

Davies and Moore (1964) used a wind tunnel to model smoke plumes and the flow about a reactor building at Bradwell, England. They then performed the corresponding field study in an effort to verify their findings. They found a critical effluent/wind speed ratio governed the entrainment of smoke into the cavity. Halitsky (1963) also showed that very short stacks (less than one-half the building height) such as are found on the EOCR building conducted herein are not different from flush vents in introducing contaminants into the cavity. His study suggests that flush vents produce similar concentration patterns in the cavity almost without regard to position on the building. The exception is when the source is next to an outer edge of the building, in which the concentration pattern is highly asymmetric but still is well mixed in the wake.

Yang and Meroney (1970, 1971) made a systematic study of gaseous dispersion about isolated buildings in a wind tunnel under stably stratified conditions. For release points on the building results indicate that within five building heights the concentration patterns are directly affected by the presence of the building, i.e., aerodynamic turbulence dominates. At distances greater than five building heights the atmospheric turbulence becomes more important. Ground level concentrations were slightly higher when a stable atmosphere was present. For stack releases of less than 1.5 building heights even high exit velocities did not prevent some entrainment into the cavity.

Snyder and Lawson (1976) performed a study to determine the validity of the "two and one-half" rule frequently used to calculate a necessary height for a stack in the vicinity of the building. Results

indicate that the effects of the building are to lower the mean height of the plume and increase the plume width when the release point is only 17 percent higher than the building.

Most recently Huber and Snyder (1976) performed a wind tunnel study to examine building wake effects on effluents from stacks near squat buildings. They presented a simple model to account for the enhanced dispersion found in the lee of the model building up to about ten building heights downstream. In the region further downstream the effect of the building could be accounted for by changing the effective source locations.

Robins (1975) studied releases from the center of the roof of a cube and the resulting downwind concentrations in a wind tunnel. When there was no effective plume rise the maximum ground level concentration was strongly a function of approach angle. The concentrations were much greater when the cube was orientated at forty-five degrees. It was shown that the presence of the building increased ground level concentrations.

Abbey (1976, 1976b), discussed the ongoing field test being performed at the EOCR complex. Little concentration data was presented, however flow visualization using an oil fog tracer was discussed. It was found that diffusion was enhanced in both the lateral and vertical directions as a result of the presence of the buildings. The effects of thermal stratification were found to be important at shorter downwind distances than had been previously thought. In addition, Abbey (1976b) provides a comprehensive comparison of most relevant past field and laboratory experiments behind structures.

In summary we can see that the results of diffusion experiments in building wakes are few and scattered. Most agree that the presence

of the buildings enhance the diffusion process in the vicinity of the building despite the degree of atmospheric stability, which dominates further downstream. The data for releases from flush vents or short stacks are in short supply, but the consensus is that gaseous products generally mix evenly in the wake to act as an area source perpendicular to the wind and can be treated in that fashion. Previous wind tunnel tests have been shown to agree reasonably well with field measurements.

Chapter 2

SIMILARITY CRITERIA

It is not the purpose of this report to present an exhaustive treatment of modeling the atmospheric surface layer. For such a treatment the reader is referred to the papers by Cermak (1971), Cermak et al. (1966), and Snyder (1972). In this chapter only those parameters that play a major role in our study will be discussed.

2.1 Simulation of Background Flow

Similarity theory is based on the assumption that if two experiments have identical dimensionless quantities then the results will be similar. Complete similarity exists if any independent set of these dimensionless products of the variables remains constant. Similarity theory suggests that there exists, near the ground, a velocity u_* which depends on the surface shearing stress τ_0 , and a length scale L (defined later) which depends on the surface heat flux.

For a neutral boundary layer ($L = \infty$) we are forced to use the height z as the characteristic height. From dimensional arguments, Tennekes (1973), we can identify one dimensionless quantity as

$$\frac{du}{dz} \frac{z}{u_*} = \text{constant} \quad (2.1)$$

rearranging

$$\frac{du}{dz} = \frac{u_*}{kz} \quad (2.2)$$

where k is the constant of proportionality called von Karman's constant and has been found by experiment to be 0.4. If we say that the velocity u goes to zero at some roughness height z_0 we can

integrate the above equation to yield the logarithmic wind profile

$$U = \frac{u_*}{k} \ln \frac{z}{z_0} \quad (2.3)$$

This equation holds only for a neutral boundary layer and for $z > z_0$.

For a neutral boundary layer the important scaling properties are u_* and z_0 . Thus the important dimensionless parameters become u_*/u_H and z_0/h_b , and for complete similarity these parameters should be identical for model and prototype. See Table I for a complete list of the dimensionless variables and their corresponding values in model and prototype.

The length L is referred to as the Monin-Obukhov length and is independent of height.

$$L = - \frac{u_*^3}{k(g/T)(H/\rho C_p)} \quad (2.4)$$

L is used to describe the condition of thermal stratification in the atmospheric boundary layer. Plate and Lin (1966) present a form of L that can readily be measured in the wind tunnel

$$L = - \frac{u_* U_\infty}{2kg} \frac{(920 + T_w + T_\infty)}{(T_w - T_\infty)} \left(\frac{\delta_T}{\delta}\right) 1/m \quad (2.5)$$

The quantity L can be used as a scaling parameter for the case of the thermally stratified boundary layer. The logarithmic linear law describes the mean velocity variation under various conditions of thermal stratification

$$U = \frac{u_*}{k} \left(\ln \frac{z}{z_0} + \beta \frac{z}{L} \right) \quad (2.6)$$

The values of α vary from $\beta = 7$ for a stable stratification to $\beta = 2$ for an unstable stratification.

Empirical studies have shown that wind profiles tend to follow a power law of the form

$$u = u_{\text{ref}} \left(\frac{z}{z_{\text{ref}}} \right)^p \quad (2.7)$$

Because p is a function of surface roughness and thermal stratification the power law relationship is valid for all stabilities. The value of p is generally large at night and small during the day (i.e., $0 < p < 1$). The power law exponent may be related to the characteristic boundary layer properties discussed earlier by the following expression

$$p = \frac{1 + \beta \frac{z_{\text{ref}}}{L}}{\ln \frac{z_{\text{ref}}}{z_0} + \beta \left(\frac{z_{\text{ref}} - z_0}{L} \right)} \quad (2.8)$$

where z_{ref} is a reference height within the similarity region of interest.

The flux Richardson number Ri_F is a measure of atmospheric stability and relates the tendency for the atmosphere to either enhance or subdue turbulence.

$$Ri_F = \frac{g}{T} \frac{(H/\rho C_p)}{u_*^2 (\partial u / \partial z)} \quad (2.9)$$

$$Ri \sim \frac{\text{rate of consumption of turbulent energy by buoyancy forces}}{\text{rate of production of turbulent energy by windshear}}$$

and

< 0	turbulence enhances -	unstable stratification
$= 0$	no tendency -	neutral atmosphere
> 0	turbulence subdued -	stable stratification

We will use a form of the Richardson number known as the bulk gradient Richardson number:

$$Ri_B = \frac{g}{T} \frac{\Delta T \Delta z}{(\Delta U)^2} \quad (2.10)$$

It is in this form that the Richardson number is an indication of the stability of the atmosphere over a finite layer rather than at a point.

Since it is often difficult to measure surface heat flux or momentum flux directly either in the field or the laboratory, the gradient Richardson number is most often specified. It is possible, however, to relate Ri_B and L through consideration of similarity theory and experimental evidence.

For $Ri_B > 0$ similarity theory suggests

$$Ri_B = \frac{1}{\alpha(\zeta_m)} \frac{\zeta_m}{1 + \beta\zeta_m} \quad (2.11)$$

where $\zeta_m = z_m/L$ is a dimensionless matching distance where the local slope matches the approximate value associated with differences taken over finite distances and $z_m = (a_2 - z_1) / \ln(z_2/z_1)$. The ratio of eddy exchange coefficients for heat and mass, $\alpha(\zeta_m)$, was found by Ellison (1957) to obey the following function for stable flows:

$$\alpha(\zeta) = \frac{\alpha_0}{R} \frac{(1 + \beta\zeta)(R + (R\beta - 1)\zeta)}{(1 + (\beta - 1)\zeta)^2} \quad (2.12)$$

where α_0 is the ratio under neutral stratification and R is a critical flux Richardson number above which no turbulence can be maintained. Experimental evidence suggests $R = 1/\beta$, $\beta \approx 7$, and $\alpha_0 = 1.2$.

For $Ri_B < 0$ a transition expression recommended from slightly unstable to free convection conditions is

$$\zeta_m = \alpha_{-\infty} \frac{Ri_B}{\sqrt[4]{1 - \gamma' Ri_B}} \quad (2.13)$$

where $\alpha_{-\infty}$ is the asymptotic value of α under free connection conditions and γ' is an empirical constant. A review of experimental evidence suggests $\alpha_{-\infty} \approx 1.3$ and $\gamma' = 18$. Figure 5 summarizes the above relations and permits one to specify L from a Ri_B measurement.

In summary the dimensionless parameters that govern similarity for an atmospheric shear layer for neutral flow fields are

$$\frac{u_*}{u_\infty} \quad \text{and} \quad \frac{z}{z_0}$$

and for stratified shear flows

$$p \quad \text{and} \quad Ri_B, \quad \text{or} \quad \frac{u_*}{u_\infty}, \quad \frac{z}{z_0}, \quad \text{and} \quad \frac{z}{L}.$$

2.2 Simulation of Flow around the Building

Geometric similarity requires that all lengths must be scaled equally in all directions. This is easily accomplished by an undistorted scale model. For this study a length scale of 1:200 was chosen so that when the model was placed in the tunnel the 1600 m sampling arc remained inside the test section.

The Reynolds number ($Re = Vh_B/\nu$) represents the ratio of characteristic inertial to viscous forces. Since the Reynolds number is usually lower in the wind tunnel test this implies that viscous forces in the model flow are more dominant than in the corresponding prototype flow. When the flow is over sharp-edged geometry mean flow patterns are independent of the Reynolds number if the Reynolds number exceeds a lower limit. Studies have been done to try to determine a

diffusion critical Reynolds number. Golden (1961) measured concentration patterns on sharp-edged cubes in a uniform flow at Reynolds numbers ranging from 2,000-90,000. Results show little change in the concentration patterns on the building for Reynolds numbers greater than 11,000. For measurements away from the building this diffusion critical Reynolds number is much lower. Shear flows will also be Reynolds number independent at an even lower value. Thus our value of $Re = 12,000$ would seem to be well into the Reynolds number independence region.

The ratios V_s/U_∞ and h_s/h_B are important factors in the determination of whether the effluent will penetrate the cavity and escape into the free stream. It is generally accepted that for $h_s/h_B > 2 \frac{1}{2}$ and $V_s/U_\infty > 1$ the effluent will penetrate the cavity (see, for example, Huber and Snyder, 1976 and Meroney and Yang, 1971). For this study with h_s/h_B ratios of 0.1, 0, and 1.2 the exit ratio was chosen to be 0.6 to insure a detectable concentration level of downwind distances of 70 building heights. To insure that the effluent thoroughly entered the cavity region this exit ratio was checked visually using a smoke visualization technique.

2.3 Simulation of Concentrations

Concentrations taken in the wind tunnel can be compared to those in the field with the use of the nondimensional concentration coefficient K_c defined by Halitsky (1968). K_c is defined as the ratio of the actual concentration at any point to a reference concentration, i.e.,

$$K_c = \frac{\chi U_H A}{Q} \quad (2.14)$$

The reference area A is a characteristic projected frontal area of the building configuration. For the present study it was decided to use $A \approx 1.5 h_b^2 \approx 800 \text{ m}^2$ (0.02 m^2 for the wind tunnel).

K_c is a function of nondimensional space coordinates x/h_B , y/h_B , and z/h_B . Since turbulent diffusion is a product of eddy motion K_c fields should be identical in dynamically similar flow fields having similar release conditions.

Chapter 3

EXPERIMENTAL APPARATUS AND MEASUREMENT TECHNIQUE

3.1 Wind Tunnel

The Meteorological Wind Tunnel, MWT (Figure 6), at the Fluid Dynamics and Diffusion Laboratory (FDDL), is described fully by Plate and Cermak (1963). The tunnel has a test section 26.8 meters long and a nominal cross-sectional area of 1.8 x 1.8 meters. The ceiling is adjustable to eliminate a longitudinal pressure gradient. Air velocities can be maintained from 0.5 to 35 meters per second with an ambient turbulence level of 0.1 percent.

The MWT was specifically designed to simulate the atmospheric boundary layer. Air inside the tunnel can be maintained at temperatures of from 0°C to 80°C. Plates cooled with an ethylene glycol solution were installed on the floor of the first twelve meter portion of the test section. This permitted the test section to be cooled to 0°C over its entire length. The final thirteen meters of the test section floor is equipped with heaters such that when the heaters are operational a temperature gradient of 122°C between the hot floor and cold air can be maintained.

3.2 Velocity Measurements

Velocity measurements were made with a Datametrics model 800LV linear flowmeter with a range of 0.0 to 30.5 m/s. The instrument was calibrated against standard pitot-static devices at the higher wind speeds. The error in velocity measurement was believed less than 1 percent. Velocity profiles were taken, using an adjustable ring stand, over the entire test section. Vertical velocity profiles taken at the model location are shown in Figure 7-10 for all stabilities.

During the experiments the velocity was continually monitored at the .14 m ht.

3.3 Temperature Measurements

Temperature measurements were made with a vertical array of YSI model 44004, fennal glass-coated bead thermistors. Manufacturers specifications suggest an accuracy of $\pm 0.2^{\circ}\text{C}$ for this type thermistor. The thermistors were connected to a YSI model 42 SC Tele-Thermometer with a range of -40°C to 150°C . The thermistors were allowed to remain in the wind tunnel during testing so that the vertical temperature gradient could be monitored. Temperature profiles for all stabilities are shown in Figure 11.

3.4 Smoke Visualization Technique

Smoke was used to define the dispersion process around and downstream of the EOCR complex. The smoke was produced by passing air through a container of titanium tetrachloride located outside the wind tunnel and transported through the tunnel wall by means of a tygon tube terminating at the model. The smoke was then successively released from the ground, rooftop, and stack heights and rotated through eight wind directions. Every effort was made to simulate the "leak" condition. No visible plume rise was noted. The smoke was illuminated with arc lamp beams. Still pictures were obtained using a 35 mm Kodak camera. Motion pictures were also taken with a Bolex camera equipped with a 200 m lens.

3.5 Oil Film Technique

A relatively new version of an old flow visualization technique redeveloped at Colorado State University was used to help describe

the flow at the surface and around the reactor complex. The technique used was to paint a light coating of a zinc oxide and commercial cooking oil on a Plexiglas plate on which the model had been mounted. The plate was inserted in the wind tunnel, air was allowed to flow for approximately one hour at 16 m/s, and then it was removed and photographed. This procedure was followed for all eight wind directions with and without the silo and oil tank buildings.

3.6 Sampling System

The concentration sampling system was constructed by the FDDL staff and is shown in Figure 12. The system consisted of six units, each with the capacity to hold eight samples. Thus a total of 48 samples can be drawn at once from the wind tunnel. The volume of each sample was 60 cc. The rate of sampling was approximately $2.42 \text{ cm}^3/\text{s}$.

3.7 Gas Chromatography Technique

A Hewlett-Packard Model 5700A gas chromatograph equipped with a flame ionization detector was used to make mean concentration measurements. The trapped sample in the sampling system, consisting of a mixture of ethane, propane and air, was drawn into the gas chromatograph by means of a vacuum pump. The sample was then carried through a column (3 foot, Poropak Q) by an inert carrier gas (nitrogen) and was separated into its components, ethane and propane. As each tracer left the column it was ionized and entered the detector. The flame ionization detector operates on the principle that the electrical conductivity of a gas is directly proportional to the concentration of the charged particles within the gas. The electrometer amplifies the output (millivolts) and is then fed to a strip chart recorder

for visual observation of the signal, and an integrating digital voltmeter for quantitative measurements. Reproducibility for successive samples was found to be within ± 5 percent.

The gas chromatograph was calibrated with a propane-ethane mixture of known concentration each day. The integrated output of this mixture was recorded and repeated several times to arrive at a calibration coefficient. A typical calibration coefficient was of the order of 0.5 ppm/mvs.

3.8 Model

A Plexiglas model (Figure 13) was constructed of the EOCR reactor building and surrounding silo and tank buildings. Prominent local terrain was also constructed of styrofoam; a sketch is shown in Figure 14. The degree of blockage based on the percent of tunnel wind flow the frontal area of the building intercepts for this size building (0.4 percent) was well below that which would affect the simulation of the flow (a heuristic rule of thumb of 1.5 percent). Three exit ports ($d = 0.0635$ m) were drilled into the model to simulate the same release positions as in the field case. The release ports are shown in Figure 13.

3.9 Tunnel Configuration

To properly model the neutral boundary layer, spires, Figure 15, were installed at the entrance of the wind tunnel, and the floor was not artificially roughened. The sampling grid arcs as laid out in the MWT were scaled to the field sample grid domain. The actual sample points were changed to better detect the plume passage. In addition vertical samples were taken on the centerline at all except the closest arc. The entire sampling grid is shown in Figure 16.

For neutral and stable cases the model was installed 11 meters from the test section entrance. This distance was sufficient to establish fully developed thermally stratified flow. For the unstable case the model was installed five meters downwind of the beginning of the heated portion of the test section floor. For all cases the sampling grid origin was the building height rooftop release position of the EOCR reactor building.

3.10 Concentration Measurement Technique

Source flow rates were adjusted to $3.3 \times 10^{-5} \text{ m}^3/\text{s}$ (exit velocity 1 m/s) for ethane, and $4.0 \times 10^{-5} \text{ m}^3/\text{s}$ (exit velocity 1.16 m/s) for propane by Fisher and Porter flowmeters (model 2F-1/4-20-5) which had earlier been calibrated for ethane and propane. The error associated with this instrument was less than 5 percent. The ethane and propane were allowed to flow through tygon tubes ($d = 0.0635 \text{ m}$) and entered the model through the floor where the ethane was released as the ground source and propane was released from the rooftop. The procedure was repeated without ethane, using propane as the tracer for the stack height release.

The gases were allowed to flow for approximately five minutes. This time was sufficient to obtain a true mean concentration. During this time 48 samples were being drawn from the wind tunnel. When the solenoid valves were closed each sample was confined to its own Plexiglas compartment. Samples were then consecutively transferred to the gas chromatograph to be analyzed for its ethane (propane) content. The output of the integrating digital voltmeter, in millivolt seconds was then recorded.

3.11 Data Reduction

The data was reduced to the nondimensional concentration coefficient K_c with the use of the following equation

$$K_c = \frac{C'(E-E_{\text{background}})U_H A}{x_{\text{source}} Q} \quad (3.1)$$

Absolute accuracy is thought to be well within ± 15 percent based on considering the worst possible mean square of accumulated error in each variable.

3.12 Experimental Procedure

The procedure for the experiment was as follows: 1) the model, velocity and temperature probes and sampling grid were installed in the wind tunnel; 2) wind tunnel heating and cooling controls were adjusted to achieve the proper thermal stratification; 3) flow visualization was performed according to sections 3.4 and 3.5; 4) concentration measurements were taken according to section 3.10; and 5) data was reduced using a CDC 6400 computer.

Chapter 4

EXPERIMENTAL RESULTS AND DISCUSSION

When an effluent is released on or near a building its dispersion is the result of three major factors; 1) the mean wind motion which carries the plume downwind; 2) the turbulent velocity fluctuation in the background flow; and 3) the added turbulence caused by the presence of the building. As a result of the added turbulence generated by the building conventional atmospheric diffusion formulae used to predict concentrations in the wake of buildings are evaluated by experimental methods.

The results of wind tunnel tests of diffusion in stratified building wakes which were performed in the neutral, stable, unstably stratified shear layer of the Meteorological Wind Tunnel at Colorado State University are presented in this chapter.

4.1 Test Program

The test program consisted of 1) a qualitative study of the flow field around the building complex using an oil film technique and visual observation of smoke released from three release ports on the building, and 2) a quantitative study of gas concentrations produced by the release of ethane and propane from the release ports.

A series of eight wind directions were used in increments of 45° measured from the north. Thus all angular locations of the approach winds are referred to in terms of angles measured from 0° (north). Four different stabilities were used based on Ri_B and Table 6 of Gifford (1975); these were Pasquill-Gifford categories; B (moderately unstable); C (neutral); E (slightly stable), and F (strongly stable). The origin of the coordinate system and thus the point from which all

downwind distances are measured is the rooftop release point. Releases from the ground level and stack height then are not necessarily released from the center of the coordinate system and some skewness is to be expected. Unless otherwise noted, the term wind velocity refers to the velocity at stack height, approximately 29 meters. However, a velocity at any height is available by referring to the velocity profiles (Figures 7-10).

The objectives of this study were 1) to obtain concentration distributions in the wake and downwind of the model industrial complex with different atmospheric stability categories, 2) to analyze these distributions to obtain information concerning the enhanced dispersion due to the presence of the building complex, and 3) to compare the plume characteristics with the predictions of several analytical and semi-empirical models currently in use. With this in mind forty-eight measurements of vertical and horizontal effluent concentrations from ground and both elevated sources were obtained for all eight wind directions and four stabilities.

4.2 Characteristics of the Background Flow

A long test section as in the MWT has a distinct advantage over short test section wind tunnels. With the addition of spires (Figure 15) the boundary layer is allowed to develop naturally over the initial 13 meters of fetch upwind of the model to a depth of about 1.8 meters. The momentum boundary layer grows rather slowly past the 13 meter station. This was confirmed by velocity profiles taken at two meter intervals starting at the 13 meter station. The variation in velocity is not appreciable downstream from 13 meters.

The thermal boundary layer grows rather rapidly in the Meteorological Wind Tunnel. Comparison of the various temperature and velocity profiles (Figure 7-11) indicate that the thermal boundary layer is approximately the same depth as the momentum boundary layer at the model placement position in the tunnel.

For the stable cases the floor was cooled to 0°C while the air was heated to 55°C which provided an adequate temperature gradient for the simulation. The bulk Richardson number was then varied by adjusting the velocity in the wind tunnel. For the neutral case no heating or cooling was required since an isothermal flow in the laboratory simulates an adiabatic lapse rate in the atmosphere. For the unstable case the air in the wind tunnel was cooled to 0°C while the floor was heated 100°C. For the purpose of evaluating the bulk Richardson number velocity and temperature measurements were made at 0.01 and 0.15 meters. This provided bulk Richardson numbers of -0.44, 0, +0.17 and +0.85 for the equivalent 2-30 meter layer in the field.

The atmospheric boundary layer was modeled to produce velocity profiles equivalent to the prototype flow with a roughness length equivalent to that of short grass ($z_0 = .04$ m, prototype). Power law exponents were evaluated using linear regression analysis of the velocity profiles, and with the use of Eq. (2.8). Table I presents the comparison of all model and prototype conditions.

Figure 17 presents velocity defect profiles in the wake of the EOGR reactor complex taken by Meroney, et al. (1977). The data suggests that by 15 building heights downstream the centerline velocity is at least 90 percent of that of the case without buildings present. Figure 18 presents decay of the mean velocity defect and turbulent

intensity excess in the wake for neutral flow. The mean velocity defect decays with a -1.13 power law decay exponent. For a complex with a width/height ratio of ~1.0 this agrees with previous experience of Peterka and Cermak (1975). The turbulence intensity excess $(U_{\text{rms}}/U)^2 - (U_{\text{rms}}/U_0)^2$ decays with a -2.7 power law exponent. A wake can be detected at distances of $X/H = 30$.

Turbulence characteristics of the MWT have been extensively examined in prior measurement programs. Arya and Plate (1969), demonstrated that for stably stratified flow fields the turbulence spectra, intensity and scales obey similarity law behavior, $\overline{u'^2}/u_*^2$, $\overline{w'^2}/u_*^2$, and $\overline{v'^2}/u_*^2$ may all be correlated by universal functions of $f(z/L)$. The influence of unstable stratification on turbulence was discussed by Arya (1972). He found temperature fluctuations correlate as $f(z/L)$; however, $\overline{u'^2}/u_*^2$ and $\overline{v'^2}/u_*^2$ for unstable flows did not so correlate. Tennekes (1973) also argues no single correlating function is possible for the horizontal turbulence variances based on similarity theory.

Figure 19 presents the mean velocity profiles measured in the wind tunnel approaching the model in terms of the coordinates of Monin and Obukhov's (1954) similarity theory. The expression that is plotted is

$$\frac{k}{u_*} \left(u(z) - u\left(\frac{L}{20}\right) \right) = \ln \frac{z}{|L/20|} + \beta \left[\frac{z}{L} + \frac{1}{20} \frac{|L|}{L} \right] \quad (4.1)$$

which is the result of subtracting the log-linear law (Eq. 2.6) evaluated at some reference level, $z_r = L/20$, from the log-linear law at any arbitrary level z . The choice of $z_r = \frac{L}{20}$ has been made for convenience so the z_{ref} falls within the thickness of the constant stress layer for all ambient velocity cases. A visual examination of

Figure 19 suggests that the stability parameter z/L correlates reasonably well the data pertaining to different stability conditions in agreement with Eq. (4.1).

4.3 Flow Visualization

4.3.1 Oil Film Technique

The purpose of using an oil film technique is to help determine the nature of the flow field at the surface around the building complex. The effect of the silo and tank building can also be studied by examining runs with and without these buildings present. This technique is also useful in determining points of separation and reattachment around the complex. Figure 20 shows regions of separation and reattachment around a cube which were defined using this oil film technique.

Figure 20 shows the flow field around the complex with all buildings present. Figure 21 shows the corresponding flow fields without the silo and tank buildings in place. When the silo and tank buildings are directly downstream the flow pattern downstream of the complex is virtually unchanged from the case of the same building orientation without these buildings present. However, when the auxiliary buildings are upstream the auxiliary buildings affect the flow by placing the reactor building in their wake. The accelerated region on each upwind face is enhanced due to the funneling effect of the silo and tank buildings for $\theta = 0^\circ$. At $\theta = 45^\circ$ no such funneling is evident; however, the effective width of the wake is 34 percent larger with the auxiliary buildings present due primarily to the effect of the silo building. At 90° and 135° the auxiliary buildings enhance the wake size by one-third at one building height downwind. For the 180°

case the silo and tank do little to enhance the wake width and have no effect on reattachment. At 225° the tank building adds a very small amount to the size of the wake while at 270° and 315° the wake size is again greatly increased.

The silo and tank buildings have little or no effect on separation and reattachment of the flow on the main reactor building. Building orientations where the auxiliary buildings are beside the reactor building have a major effect on the size of the wake regions, in some cases increasing it as much as 38 percent. However orientations where they are directly up or downwind have little effect. Certain orientations (0° , 45° , 270° , 315°) cause the normally accelerated region next to the reactor building to be enhanced and almost a jetting action results. Regions of separation and reattachment are shown in the figures.

4.3.2 Smoke Visualization

4.3.2.1 Ground Level Release (Figure 22). Smoke visualization was performed for all cases under the conditions listed in Table I and Figures 7 through 11. All wind directions and stratifications show smoke being well, but not uniformly, entrained into the cavity region. The effects of the auxiliary buildings are noticed for $\theta = 0^\circ$. For this orientation the ground release port is in the wake region of the silo building. For this reason the smoke recirculates to the roof of the silo building and gets caught in the tank wake. The effects of the terrain are noticeable for $\theta = 315^\circ$ where the smoke moves around to the northeast face (the side that is not built up) and becomes entrained again into the silo wake. When the release is directly downwind ($\theta = 135^\circ$) the smoke is recirculated to the leading edge of the rooftop and becomes entrained into the wake of the stack

and appears as stack downwash. For $\theta = 270^\circ$ the accelerated region is very noticeable between the reactor and silo building.

4.3.2.2 Building Height Release (Figure 23). All wind directions show smoke being well entrained into the cavity region. The most noticeable aspect of the building height release is the behavior of the plume immediately after emission. For $\theta = 90^\circ$ and $\theta = 180^\circ$ the smoke jets to the downwind corner hugging the rooftop where it is deposited into the cavity region. This phenomenon only occurs when the flow is not disrupted by the presence of the auxiliary buildings. For other orientations the smoke is distributed on the rooftop sometimes extending to the leading edge ($\theta = 135^\circ, 225^\circ$), and sometimes extending to the corner edges where it comes off ($\theta = 270^\circ$).

4.3.2.3 Stack Height Release (Figure 24). The amount of effluent that enters the cavity region varies with wind direction. For $\theta = 0^\circ, 270^\circ$, and 315° the smoke is well entrained into the wake, sometimes recirculating back up to the leading edge of the rooftop level. These cases show little differences from ground or building height releases. Building orientations of $\theta = 45^\circ, 135^\circ$, and 225° show very little entrainment into the wake. Stack downwash is present in all cases except $\theta = 45^\circ$ and 135° .

4.3.2.4 Stratification Effect on Plume Dispersion Near the Building. For different thermal stratifications dispersion patterns can vary significantly downstream from the buildings. Near the buildings however, the dispersion is dominated by the mechanical turbulence generated by the building. The effects of a thermally stratified flow are shown in Figures 22 to 24. The major difference noted for the strongly stable case is the "puddle" effect where the

smoke from a ground level release would lie almost stagnant on the floor showing very little movement. This occurred for $\theta = 0^\circ, 225^\circ, 270^\circ$ where the release is into the wake of the silo building. However, the smoke that was recirculating into the wake region did not show significant differences from that of the neutral case.

4.4 Concentration Measurements

In evaluating air quality often the major concern is the concentration of pollutants at ground level. This is the concentration that must be kept below minimum standards.

All concentrations for this study were converted to the nondimensional concentration coefficient K_c

$$K_c = \frac{\chi \bar{U} A}{Q} \quad (4.1)$$

Figure 25 is a graph of nondimensional vertical plume spread, σ_z , vs. nondimensional distance downstream x/h_B that compares the vertical dispersion with distance as a function of release height, stability and presence of the buildings. Values of σ_z tend to increase with decreasing stability for the cases without the buildings, although the rates (slopes) of dispersion are nearly equal. Data points are also compared to the standard Pasquill-Gifford curves, Slade (1968), for plume growth. The values agree reasonably well. A best fit curve is shown that best describes the natural data; the expression for this curve is

$$\frac{\sigma_z}{h_B} = 0.08 \left(\frac{x}{h_B}\right)^{0.9} \quad (4.2)$$

The data points indicate that the vertical growth of the plume is greatly enhanced by the presence of the building for cases of both ground and elevated releases.

Figure 26 shows the same comparison for values of the lateral plume spread, σ_y . Results show that values of σ_y are substantially larger than the corresponding values of σ_z . As in the case of σ_z the values of σ_y tend to increase with decreasing stability for the cases without buildings present. For the ground level release the lateral growth of the plume is greatly enhanced while no such enhancement is noticed for the elevated release. A best fit curve is shown that best describes the neutral data; the expression for this curve is

$$\frac{\sigma_y}{h_B} = 0.16 \left(\frac{x}{h_B}\right)^{0.9} \quad (4.3)$$

which is in close agreement to the above expression for σ_z/h_B .

The power law exponent, 0.9 for both expressions, is in close agreement with the work of previous authors (Huber and Snyder, 1976; Robins, 1975). Slopes of the field values for σ_y and σ_z as correlated by Pasquill-Gifford are essentially indistinguishable from those reported herein (see Figures 25 and 26). Huber and Snyder report a power law exponent of 0.8 while Chaudhry and Meroney report values of 0.99 for σ for wind tunnel experiments of diffusion.

Comparing the curves for lateral and vertical plume spread is a convenient method to estimate stability categories. Inspection of Figures 25 and 26 indicate that the slightly unstable case is indicative of stability class B, neutral conditions fall between C and D, while

slightly unstable represents almost E type stability and strongly stable is between E and F. Specification of diffusion category by means of Monin-Obukhov stability length, L , specifies the same Pasquill categories as found by the variance behavior (see Gifford, 1975)(see Table I).

In addition to the many cases with buildings present, concentration data was taken for the case without the buildings for the slightly unstable, neutral, and stable cases. This data is presented in Figure 27. These runs are compared with the Pasquill-Gifford curves for C and D stabilities derived from the standard Gaussian model using values of σ_y and σ_z from Turner (1970). Also included in this graph is the same standard model which uses the expressions derived earlier in Eqs. (4.2) and (4.3) to arrive at the appropriate values of σ_y and σ_z . This expression is

$$\frac{\sigma'_y}{h_B} \cong \frac{\sigma_y}{h_B} \cong \frac{\sigma_z}{h_B} \cong 0.10 \left(\frac{x}{h_B}\right)^{0.9} \quad (4.4)$$

The modified Gaussian equation shows excellent agreement for the case of neutral stratification without buildings present. The data points fall between the Pasquill-Gifford C and D curves indicating that the appropriate stability category for wind tunnel experiments of diffusion without stratification should be something like a C-.

4.4.1 $x/h_B > 15$ with Buildings Present

Ln-ln graphs of K_c vs. x/h_B are presented in Figures 28 to 35. The slopes of the curves show little variation past $x/h_B = 15$ and are equal to -1.8. The effect of stability in that region is to increase ground level concentrations for the stable categories while

decreasing ground level concentrations for the unstable case. This is due to the enhanced turbulence for the unstable case which tends to increase the dispersion capability of the layer, whereas for the stable case the turbulence generated by the buildings is subdued and the maximum concentration remains close to the ground.

4.4.2 $x/h_B < 15$ with Buildings Present

In the vicinity of the building the major fraction of the dispersion is the result of the mechanical turbulence generated by the building. Of course shifting in the approach wind orientation may change considerably the character of the turbulence in the immediate cavity wake. Thus the more effluent that enters the cavity the greater the concentration will be at ground level. This can be seen in Figures 28 to 35. Ground level releases that have nearly 100 percent of their effluent in the cavity show the highest concentrations while stack level releases, where some effluent escapes the cavity, show lower ground level concentrations. Thus, where the stack level concentrations approach that of the ground level release is an indication of where the elevated plume becomes entrained into the wake and is brought to ground level. This seems to occur generally by eight building heights, however, for $\theta = 45^\circ$ and 315° this does not occur until at least 15 building heights. This would indicate a longer wake axis for these orientations.

Relative concentrations in the wake region give a good indication of the dispersal capability of the wake for that specific building orientation. The greatest concentrations are found for $\theta = 270^\circ$ at 1.65 building heights downstream for all release ports. This indicates

that for this orientation the effluent is not dispersed as rapidly as for the other orientations.

As mentioned earlier thermally stratified flow dispersion patterns can vary significantly. Even though in the wake of the building aerodynamic turbulence dominates, the effects of stratification are noticeable. Strongly stable stratification results in higher concentrations, a possible result of puddle effect mentioned earlier and subdued dispersion in the vertical direction. Slightly lower concentrations resulted for the case of unstable stratifications.

4.4.3 Diffusion Isopleths

In Figures 36 to 50 the isopleths (equi-concentration contours) are plotted for various building orientations, releases, and stratification. It should be noted that the horizontal scale has been distorted for all cases to allow proper resolution in the near wake region.

Figures 36 to 39 present the comparison of diffusion isopleths for case of $\theta = 135^\circ$ (downstream face) for all four stratifications and a ground level release. The isopleth for $K = 1.0$ increases in length downstream with increasing stability. This indicates the relative decrease in the dispersal capacity of the stable atmosphere despite the presence of the building.

The effects of stratification are seen in Figures 40 to 42 which represent the stack level release for $\theta = 315^\circ$ and all stability categories. This sequence shows that for the slightly unstable and neutral cases the plume is brought to the ground very close to the building ($x/h_b = 2$). This would indicate that the plume does not remain above the cavity, but intercepts it and is brought quickly to

the ground. Comparing Figures 40 and 42 one can see that concentrations decrease much more rapidly downstream for the unstable case and at the same height downstream are an order of magnitude lower.

Figures 47 to 50 present the isopleths for $\theta = 315^\circ$ (upstream face) for the same above conditions. The most obvious aspect is that of the skewness involved. The reason for the skewness is the terrain which rises sharply 3.5 meters immediately next to the release port. The terrain influences the dispersion in that the effluent is forced around the opposite side of the reactor building.

Maximum ground level concentrations are found for the case of $\theta = 270^\circ$ where a value of $K_c = 34$ was found for the slightly stable case. This is due to a combination of the jetting action down the face and the puddle effect.

4.5 Comparison

4.5.1 Discussion of Models

Many methods have been used in the past for predicting ground level concentrations in the wake of buildings. Some of the more simple and immediately applicable techniques are discussed and compared to the results of the present study in this chapter.

The Gaussian plume model is the basis for most models which predict concentration in building wakes. The Gaussian formulae are modified in some manner to account for the enhanced dispersion in the immediate wake. The centerline ground level concentrations released from ground level as predicted by the dimensionless version of the Gaussian point source diffusion model are:

$$\frac{\bar{\chi}\bar{U}A}{Q} = \frac{A}{\pi\sigma_y\sigma_z} \quad (4.5)$$

The object of most building wake diffusion models now is to make the denominator somehow larger either by adding a term or modifying values of σ_y and σ_z .

The simplest model is that by Gifford (1960) which suggests

$$\frac{\bar{x}\bar{U}A}{Q} = \frac{A}{\pi\sigma_y\sigma_z + CA} \quad (4.6)$$

where values of C are intuitively suggested to range from 1/2 to 2. This model is based on Fuquay's (Slade, 1960) volume source model where the assumption is made that effluent mixes rapidly into a uniformly distributed volume and thus disperses as a volume source. However, Halitsky (1962) observed that the real concentration in the cavity was not uniformly distributed. Similar results are observed in this study, as discussed earlier. However, even with these failings Gifford's model, Eq. (4.6) does a reasonably good job in predicting ground level concentrations in the vicinity of the building from $1 < x/h_B < 10$. Comparison of this simple model to the present study will be made in later sections.

A model suggested recently by Halitsky (1975) uses the standard Gaussian plume model but alters σ_y and σ_z . The model uses

$$R_y(x) = R_y(0) + \Delta R_y(x, \text{stability})$$

$$R_z(x) = R_z(0) + \Delta R_z(x, \text{stability})$$

where

$$R_y(x) = \text{plume boundary half width at distance } x$$

$$R_z(x) = \text{height at distance } x$$

$$R_y(0) = \text{complex half width}$$

$$R_z(0) = \text{complex height above ground}$$

$$\Delta R_y = 2.5 \sigma_y \quad (\text{from Turner 1970})$$

$$\Delta R_z = 2.5 \sigma_z \quad (\text{from Turner 1970})$$

and values of σ_y and σ_z were calculated as follows:

$$\begin{aligned}\sigma_y &= 0.4 R_y(x) \\ \sigma_z &= 0.4 R_z(x)\end{aligned}\tag{4.7}$$

To adapt this model to the present study the complex half width was estimated from the oil--film flow visualization to be 30 meters. The complex height was taken as 23 meters. The results of this model are discussed in a future section. This model is somewhat similar to an earlier model proposed by Yansky et al. (1966)

$$\frac{\chi UA}{Q} = \frac{A}{\pi \sigma_y^2 + C(A)}^{1/2} (\sigma_z^2 + C(A))^{1/2}$$

The last model to be discussed is that by Huber and Snyder (1976). This model is similar to Halitsky's in that it also modifies the horizontal and vertical dispersion parameters. This model assumes that in the near wake ($x/h_B < 10$) the dispersion is controlled by the high intensity turbulence close to the building. But since this turbulence rapidly decays, the dispersion in the far wake was controlled by the background atmospheric turbulence whose dispersion parameters were given by the standard Gaussian curves (Turner, 1970) and were related to a virtual source a distance S upstream from the release point.

The model for the enhanced dispersion parameters is given by:

$$\frac{\sigma'}{h_B} = [C_1 + C_2 \left(\frac{x}{h_B}\right)^{C_3}]^{0.5} \frac{\sigma}{h_B}$$

where $\frac{\sigma}{h_B}$ is the relationship for plume spread without the building present. For the present study

$$\frac{\sigma}{h_B} = \frac{\sigma_y}{h_B} = \frac{\sigma_z}{h_B} = 0.06 \left(\frac{x}{h_B}\right)^{0.9}$$

was found to agree well with the data. The constant C_3 is determined by the rate of longitudinal turbulence excess decay behind the building (see Figure 18). This data was taken behind the building used for this present study by Meroney et al. (1976) and the value of C_3 was determined to be -2.7. Values of C_1 and C_2 were determined from the plume spread in the near wake region. The resultant expression:

$$\frac{\sigma'}{h_B} = 0.45 + 0.06\left(\frac{x}{h_B} - 3\right) \quad (4.8)$$

was found to fit the data for this experiment for the region $3 \leq x/h_B \leq 10$. The variation in concentration implied by this equation is shown in Figure 51.

Further downwind the dispersion is taken over by atmospheric turbulence and thus can be described in the standard Gaussian way. Huber and Snyder suggest the use of a virtual source method given by

$$\frac{\sigma'}{h_B} = +0.06\left(\frac{x}{h_B} + S\right)^{0.9} \quad (4.9)$$

For this study better agreement was found when the virtual source was taken to be zero. In other words beyond $x/h_B > 20$ downwind the concentrations converged to those given by the standard Gaussian model. Huber and Snyder found that for the case of the ground level release both the horizontal and vertical dispersion parameters should be adjusted. For the elevated release only the vertical dispersion is enhanced. These results are consistent with those obtained by Huber and Snyder (1976).

4.5.2 Comparison with Observed Data

As shown in Figure 27, Eq. (4.4) predicts reasonably well ground level concentrations for the case of the neutral ground level release without buildings present.

It was felt that since for all these models the assumption was made that the effluent was uniformly distributed in the vertical that the appropriate case to make comparisons with would be ground, building and stack height releases from a downwind face. Figure 51 presents the comparison of Eqs. (4.2), (4.3), and (4.5). For ground level releases Gifford's model Eq. (4.6) did the best job in predicting concentrations when a value of $C = 1$ was used. The modified Gaussian equation, Eq. (4.8) also showed good agreement. Halitsky's model, Eq. (4.7) drastically underpredicted ground level concentrations. However this model could probably suffice if the constants were adjusted. For releases from building and stack height the only model that was compared was that of Huber and Snyder. Poor agreement was found between the modified Gaussian model and the observed data.

4.6 Correlation of Wind Tunnel Measurements to Field Measurements

The ambient concentration of a pollutant measured downwind from a source which will fluctuate with time as turbulence and meandering move the plume around. The result is that very short sampling times are apt to either record a very high or very low concentration. Thus in a one-hour average of the ambient concentration a crosswind plane is likely to be quite different from the profile the plume has at any one instant. In general we can say that the sampling time must be sufficiently long to encompass the period for the most important components of the fluctuations. Wind tunnel tests, then, are

analogous to field situations where the wind is "steady", from a constant direction with a constant velocity (truly a highly idealized situation). We can see then that averaging times in the wind tunnel correspond to shorter averaging times to those in the field.

Because in the wake of a building the dispersion is dominated by the mechanical turbulence and eddies no larger than the building height generated by the building and not the large-scale eddies which produce the meandering of a plume, it is concluded that K-factors should correlate well with field measurements in the cavity region behind the building. In a wind tunnel where meandering is not present then peak concentrations in the field should correspond well with wind tunnel measurements.

An extensive review of thoughts proposed on the influence of averaging time on concentrations is found in Brun et al. (1973). Most authors suggest a power law behavior with time. Brun finds no consistent variation in the power law with stratification. For time periods ranging from 10 minutes to several hours the work of Hino seems to agree best with the experimental median. Hino (1968) performed a large-scale study to determine the exponent. Hino suggested that atmospheric stability has only a small effect on the exponent of the power law and suggested

$$\chi \sim t^{-1/2}$$

Experiments by Hinds (1967) support the $-1/2$ power law.

Laboratory measurements of σ_y/h_B and σ_z/h_B for isolated releases at ground level vary with distance downwind in the same manner as field results when averaged over five to twenty minute sampling periods. (Pasquill-Gifford curves for σ_y and σ_z result

from field data sampled over five to twenty minutes.) Thus one might reasonably assign a minimum effective full-scale averaging time of ten minutes to mean laboratory data. Thus, we should be able to relate a one-hour averaging time in the field to wind tunnel measurements by

$$x_{1 \text{ hr}} = x_{\text{model}} \frac{t_{1 \text{ hr}}}{t_{\text{model}}}^{-1/2}$$

and if $t_{1 \text{ hr}} = 60$ minutes and $t_m = 10$ minutes, we get

$$x_{1 \text{ hr}} = 0.4 x_m$$

or wind tunnel measurements of diffusion overpredict concentrations by a factor of 2.4 for typical near neutral flow conditions.

Chapter 5

CONCLUSIONS

Information about dispersion in the wake of an industrial complex has many practical applications. From the study described in this report the following conclusions can be made.

1. In the near wake region dispersion patterns significantly differ from those without the buildings present and cause lower concentrations.
2. At some distance downwind, generally by $x/h_B = 8$, the rate of dispersion is independent of release position and building orientation.
3. Minor additions to the building complex cause significantly altered flow and dispersion patterns but only in preferred orientations.
4. Minor changes in topography near the building also can significantly effect the dispersion patterns by diverting the flow around one part of the building.
5. In the cavity-wake region behind the building aerodynamic turbulence dominates over the atmospheric turbulence but the effects of the latter are still slightly visible in the flow visualization sequences.
6. Further downwind the atmospheric turbulence begins to take over and completely dominates by $x/h_B = 15$.
7. For $x/h_B > 15$ concentrations are virtually independent of whether or not the buildings were present.

8. The effects of stratification are to cause slightly higher concentrations for stable atmospheres while slightly lower concentrations are noticed for unstable stratifications.
9. The effect of the buildings is to enhance the dispersion (mostly in the horizontal) and cause lower concentrations. These lower concentrations may be accounted for by the use of either Gifford's volume source model, Eq. (4.2) or the model of Huber and Snyder, Eq. (4.4). Because the latter model requires detailed knowledge of the flow structure in the wake which is sometimes difficult to obtain Gifford's model appear preferable. Gifford's model, however, cannot account for elevated releases. Huber and Snyder's model underpredicts concentrations very close to the building for elevated releases.
10. Ground level releases in the wake of the structure tend to enhance the dispersion in both the horizontal and vertical, while elevated releases enhance only the vertical. This conclusion was also reached in the previous study by Huber and Snyder (1976).

REFERENCES

- Abbey, R. F., 1976, "Diffusion around Nuclear Reactors Located in Flat Terrain: An Experimental Investigation," Paper presented at 69th Annual Meeting of APCA.
- Abbey, R. F., 1976b, "Concentration Measurements Downwind of Buildings: Previous and Current Experiments," Third Symposium on Atmospheric Turbulence Diffusion and Air Quality, October 19-22, 1976, Raleigh, North Carolina, pp. 247-254.
- Arya, S. P. S. and E. J. Plate, 1969, "Modeling of the Stably Stratified Atmospheric Boundary Layer," *Journal of the Atmospheric Sciences*, Vol. 26, pp. 656-665.
- Arya, S. P. S., 1972, "Free Convection Similarity and Measurements in Flows with and without Shear," *Journal of the Atmospheric Sciences*, Vol. 29, pp. 877-885.
- Birkhoff, G. and E. H. Zarantonello, 1957, Jets, Wakes, and Cavities, Academic Press, New York.
- Brun, J., J. Hogan, and R. LeQuinio, 1973, "Influences of Exposure Duration on the Evaluation of Coefficients of Atmospheric Diffusion," Symposium on the Physical Behavior of Radioactive Contaminants in the Atmosphere, Vienne, November 12-16, 24 p.
- Cermak, J. E., V. A. Sandborn, E. J. Plate, G. H. Binder, H. Chuang, R. N. Meroney, and S. Ito, 1966, "Simulation of Atmospheric Motion by Wind Tunnel Flows," FDDL Report CER66JEC-VAS-EJP-GJB-HC-RNM-SI17, Colorado State University.
- Cermak, J. E., 1971, "Laboratory Simulation of the Atmospheric Boundary Layer," AIAA Journal, Vol. 9, No. 9, pp. 1746-1754.
- Chaudhry, F. H. and R. N. Meroney, 1969, "Turbulent Diffusion in a Stratified Shear Flow," FDDL Report CER69-70FHC-RNM12, Colorado State University, September.
- Davies, P. O. A. L. and D. J. Moore, 1964, "Experiments on the Behavior of Effluent Emitted from Stacks at or near the Roof Level of Tall Reactor Buildings," International Journal of Air and Water Pollution, Vol. 8, pp. 513-533.
- Ellison, T. H., 1957, "Turbulent Transfer of Heat and Momentum from an Infinite Rough Plane," Journal of Fluid Mechanics, 2, No. 5, pp. 456-466.
- Gifford, F. A., 1960, "Atmospheric Dispersion Calculations Using the Generalized Gaussian Plume Model," Nuclear Safety, 2, pp. 56-59.

- Gifford, F. A., 1975, "Turbulent Diffusion Typing Schemes: A Review," Environmental Research Laboratories, ATDL Report No. 75/2, or, 1976, Nuclear Safety, 17, No. 1, pp. 68-86.
- Golden, J., 1961, "Scale Model Techniques," M.S. Thesis, New York University, Department of Meteorology and Oceanography.
- Halitsky, J., 1963, "Gas Diffusion Near Buildings," ASHRAE Transaction, pp. 464-484.
- Halitsky, J., 1968, "Gas Diffusion Near Buildings," Meteorology and Atomic Energy, pp. 221-231.
- Halitsky, J., 1975, "Mean Speed, Turbulence and Diffusion in the Wake of the EBR II Building Complex," Submitted to Atmospheric Environment for publication.
- Hinds, W. T., 1967, "On the Variation of Concentration in Plumes and Building Wakes," USAEC Meteorological Information Meeting, pp. 105-131 and "Peak to Mean Concentration Ratios in Building Wakes," Vol. 3, No. 2, March 1969, pp. 145-156.
- Hino, M., 1968, "Maximum Ground Level Concentration and Sampling Time," Atmospheric Environment, Vol. 2, pp. 149-165.
- Huber, A. H. and W. H. Snyder, 1976, "Building Wake Effects on Short Stack Effluents," Preprint Volume, Third Symposium on Atmospheric Turbulence, Diffusion and Air Quality.
- Kalinske, A. A., R. A. Jensen, and C. F. Schadt, 1945, "Wind Tunnel Studies of Gas Diffusion in a Typical Japanese Urban District," OEMsr-1243, Informal Report 10.3-48, Iowa Institute of Hydraulic Research, State University of Iowa, Iowa City, Iowa.
- Martin, J. E., 1965, "The Correlation of Wind Tunnel and Field Measurements of Gas Diffusion using Krypton-85 as a Tracer," Michigan Memorial Phoenix Project 272, University of Michigan, Ann Arbor, Michigan.
- Meroney, R. N. and B. T. Yang, 1971, "Wind Tunnel Study on Gaseous Mixing Due to Various Stack Heights and Injection Rates above an Isolated Structure," FDDL Report CER71-72RNM-BTY16, Colorado State University.
- Meroney, R. N., J. A. Peterka, R. V. Hatcher, K. K. Kothari, 1977, "Gaseous Dispersion and Turbulence in the Wake of Nuclear Reactor Plants," to be presented at 4th ICAC meeting, Tokyo, Japan.
- Monin, A. S. and A. M. Obukhov, 1954, "Basic Regularity in Turbulent Mixing in the Surface Layer of the Atmosphere," USSR Acad. Sci. Geophys. Inst., No. 24.
- Peterka, J. A. and J. E. Cermak, 1975, "Turbulence in Building Wakes," FDDL Report CER74-75JAP-JEC34.

- Plate, E. J. and J. E. Cermak, 1963, "Micro-Meteorological Wind Tunnel Facility: Description and Characteristics," FDDL Report CER 63JP-JEC9, Colorado State University.
- Plate, E. J. and C. W. Lin, 1966, "Investigations of the Thermally Stratified Boundary Layer," Fluid Mechanics Paper No. 5, Colorado State University.
- Robins, A. G., 1975, "Plume Dispersion in the Vicinity of a Surface Mounted Cube," CEEB Report R/M/R220, United Kingdom.
- Sagendorf, J. F. and C. R. Dickson, 1974, "Diffusion under Low Wind Speed Inversion Conditions," NOAA Technical Memorandum ERLARL-52.
- Sherlock, R. H. and Stalker, E. A., 1940, "The Control of Gases in the Wake of Smokestacks," Mechanical Engineering, Vol. 62, No. 6, pp. 455-458.
- Sherlock, R. H. and E. A. Stalker, 1941, "A Study of Flow Phenomena in the Wake of Smokestacks," Engineering Research Bulletin, No. 29, Department of Engineering Research, University of Michigan, Ann Arbor, Michigan.
- Slade, D., ed., 1968, Meteorology and Atomic Energy-1968, U.S. Atomic Energy Commission, Division of Technical Information, 455 p.
- Snyder, W. H., 1972, "Similarity Criteria for the Application of Fluid Models to the Study of Air Pollution Meteorology," Boundary Layer Meteorology, 3(2), pp. 113-134.
- Snyder, W. H. and R. E. Lawson, Jr., 1976, "Determination of Height for Stack near Building," EPA Report No. EPA600/4-76-001.
- Tennekes, H., 1973, in Workshop on Micrometeorology, Haugen Ed., Chapter 5, American Meteorological Society, Boston.
- Turner, D. B., 1969, "Workbook of Atmospheric Dispersion Estimates," U.S. Department of Health, Education and Welfare, Public Health Service, Cincinnati, Ohio.
- Woo, H. G. C., J. A. Peterka, and J. E. Cermak, 1976, "Wind Tunnel Measurements in the Wake of Structures," FDDL Report CER75-76HGCW-JAP-JEC40.
- Yang, B. T. and R. N. Meroney, 1970, "Gaseous Dispersion into Stratified Building Wakes," FDDL Report CER70-71BTY-RNM8, Colorado State University.
- Yansky, G. R., E. H. Markee, Jr., and A. P. Richter, 1966, "Climatology of the National Reactor Testing Station," IDO-12048, USAEC, Idaho Falls, Idaho, 184 p.

FIGURES

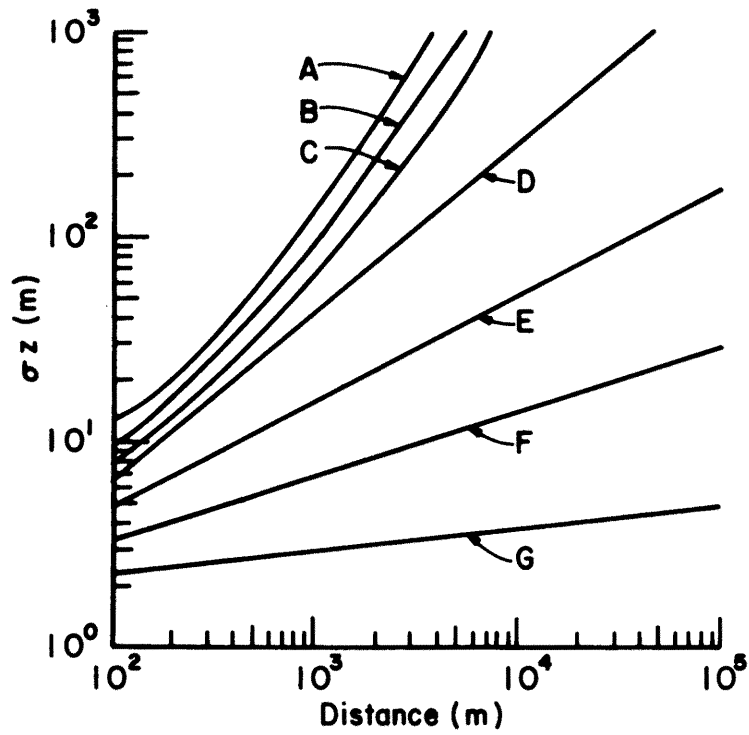

Figure 1. Sigma z from Markee

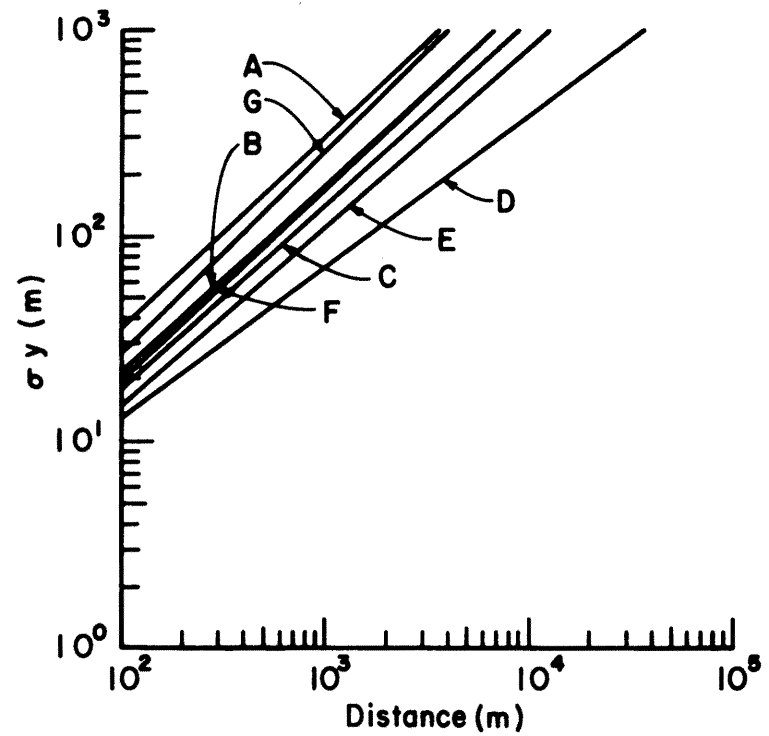

Figure 2. Sigma y from Markee

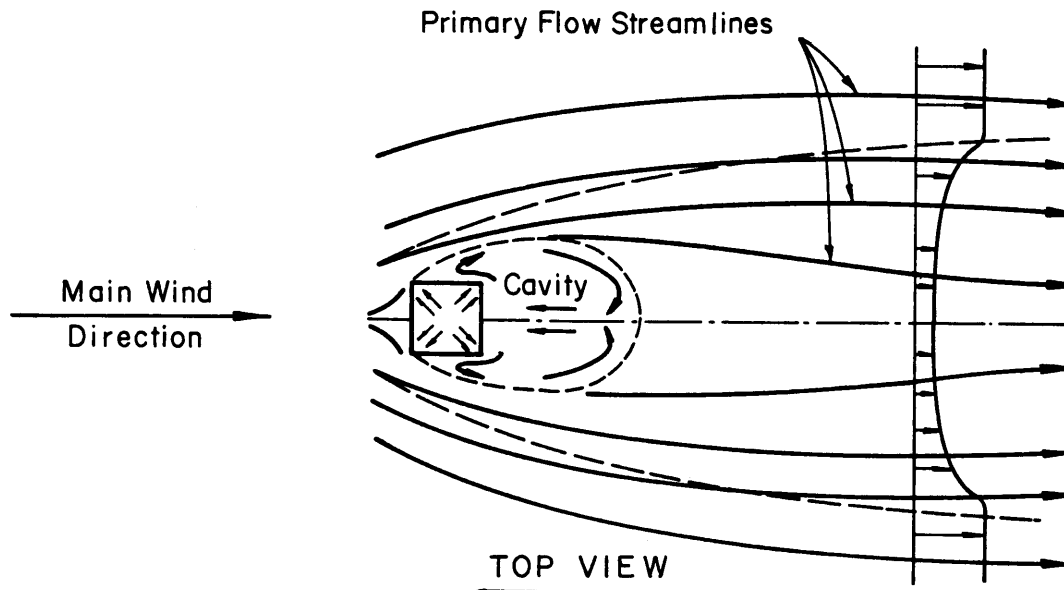
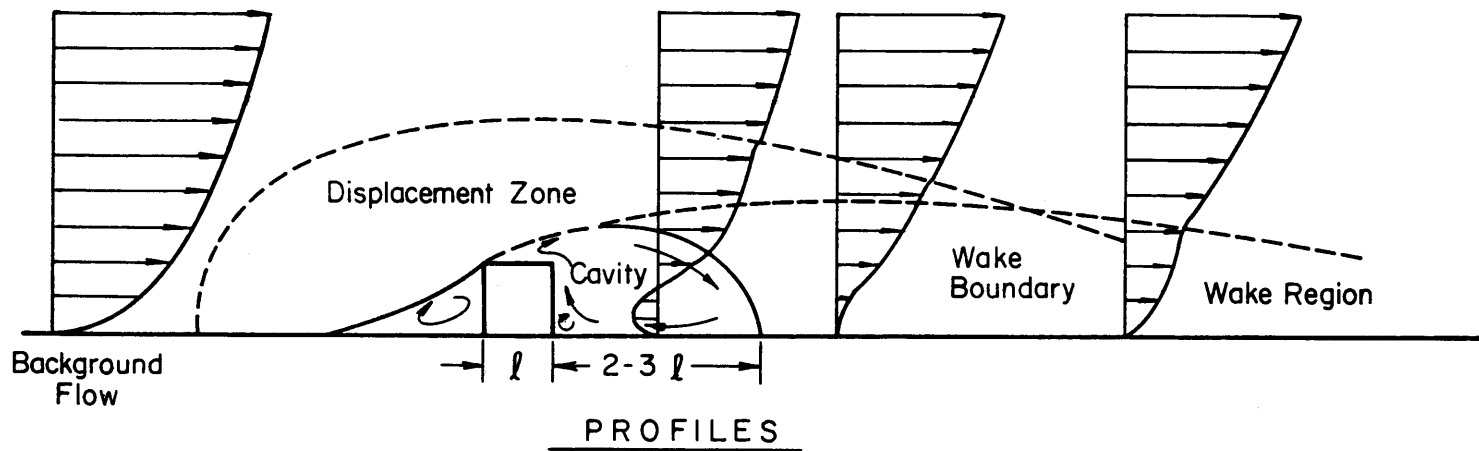

Figure 3. Flow fields past a cube (from Halitsky, 1968)

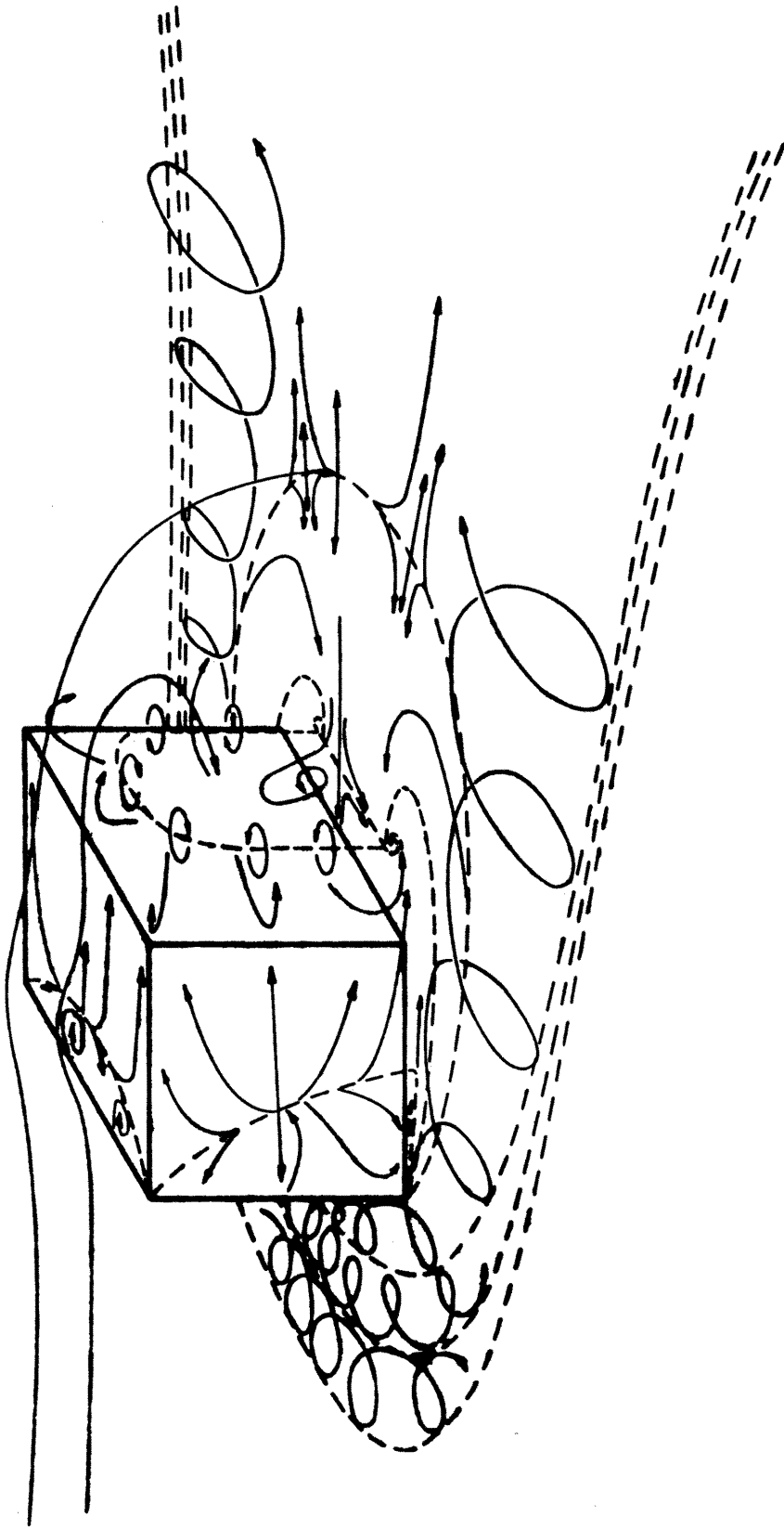

Figure 4. Flow pattern past a cube (from Woo, 1976)

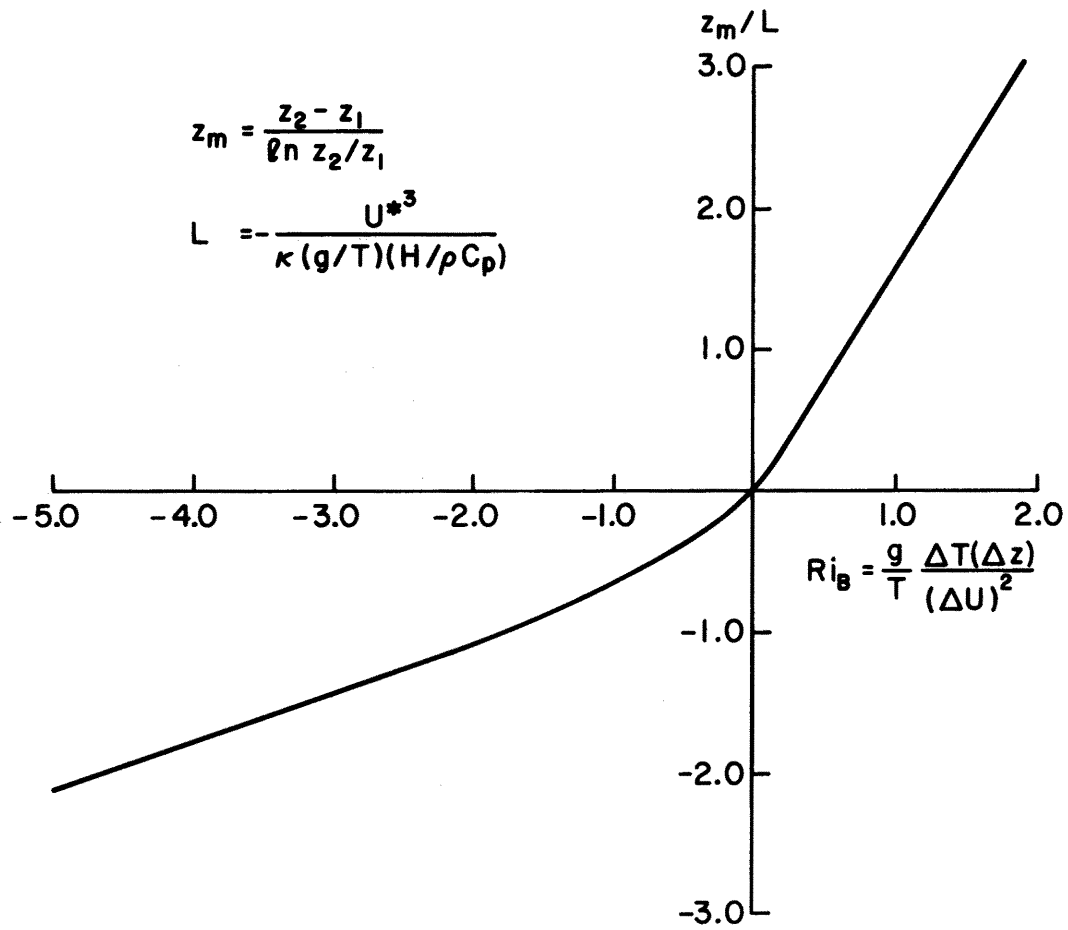

Figure 5. Variation of Monin-Obukhov length L with bulk Richardson number

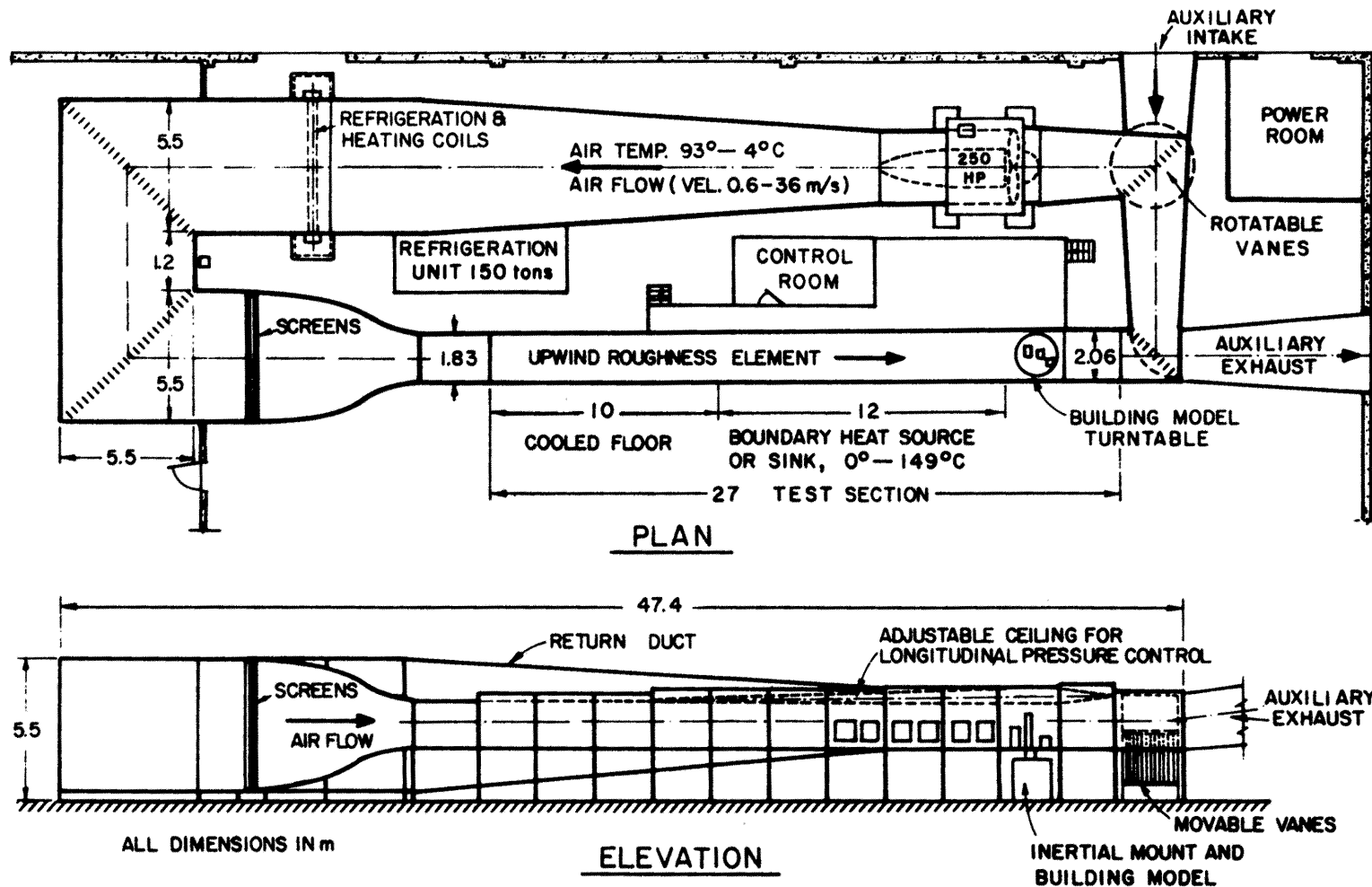

Figure 6. METEOROLOGICAL WIND TUNNEL (Completed in 1963)
 FLUID DYNAMICS & DIFFUSION LABORATORY
 COLORADO STATE UNIVERSITY

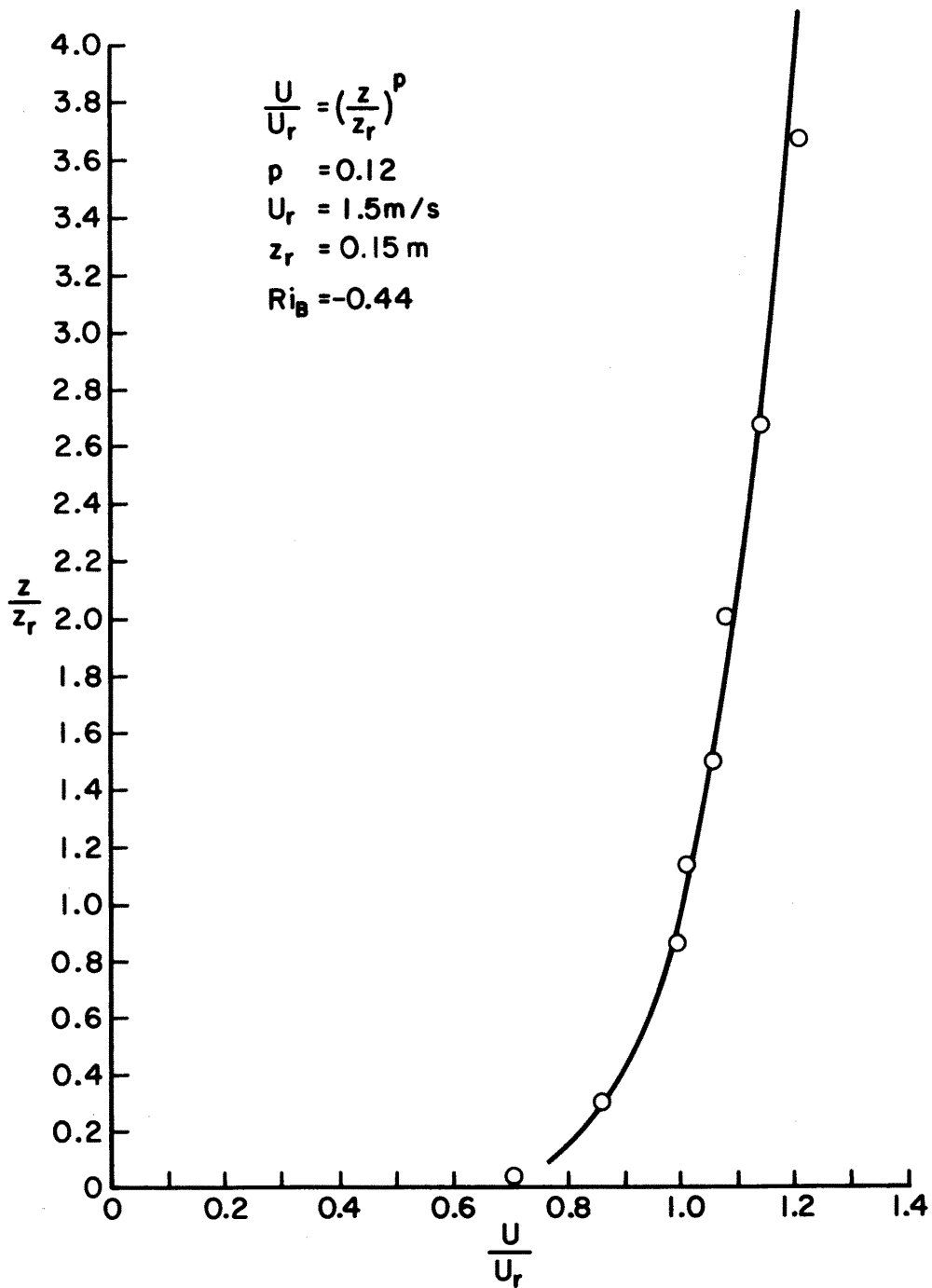

Figure 7. Velocity profile, slightly unstable stratification

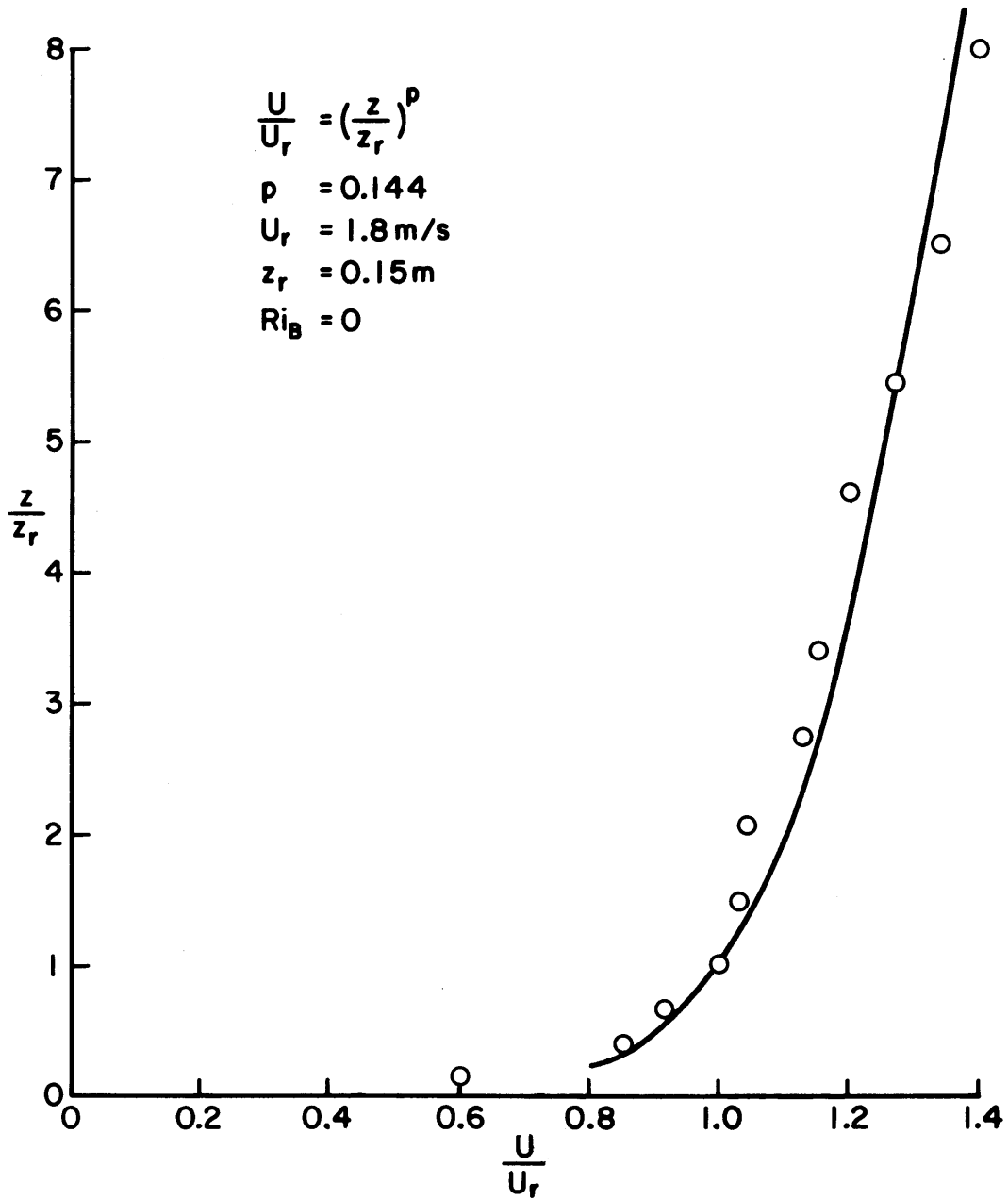

Figure 8. Velocity profile, neutral stratification

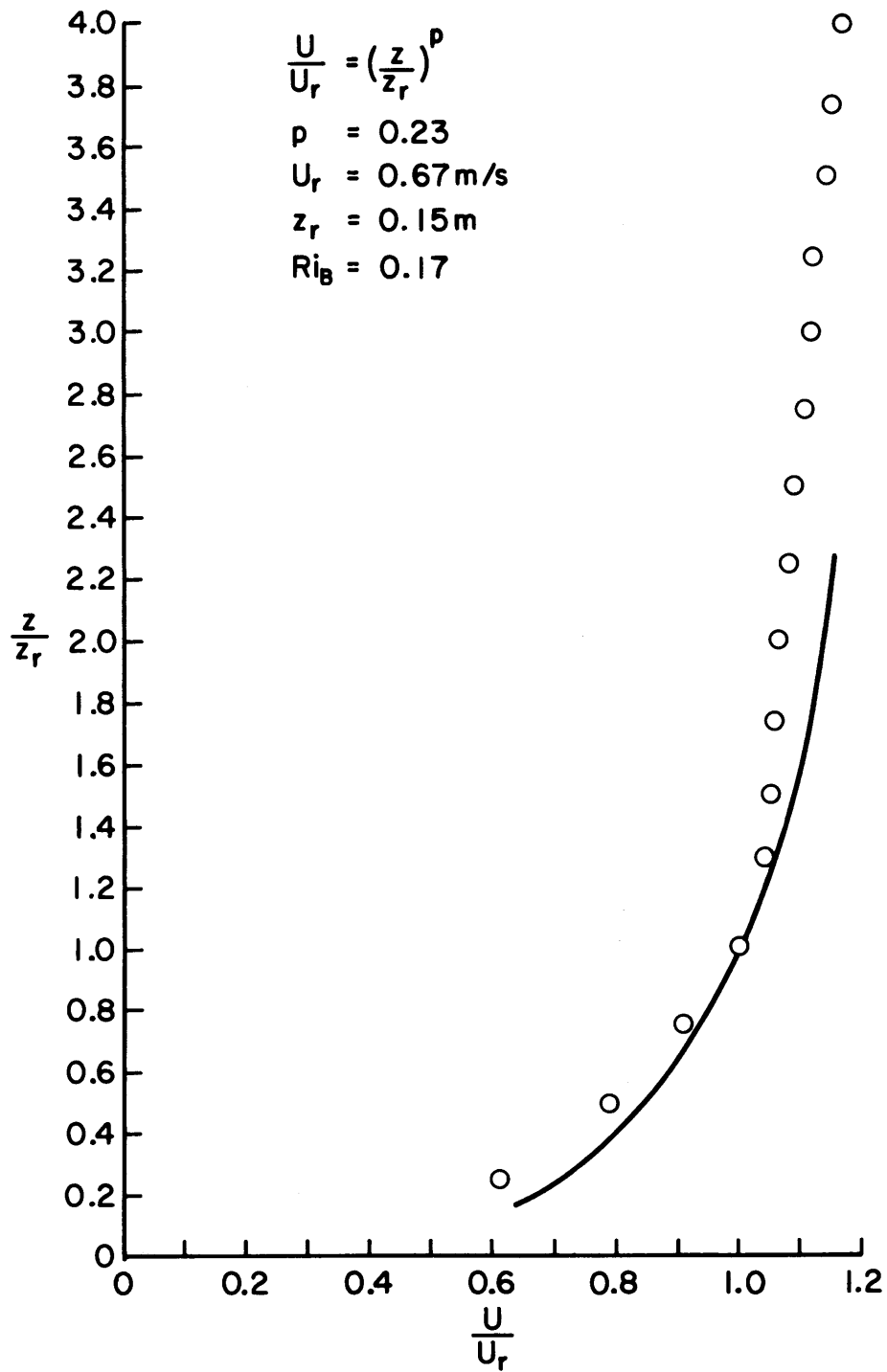

Figure 9. Velocity profile, slightly stable stratification

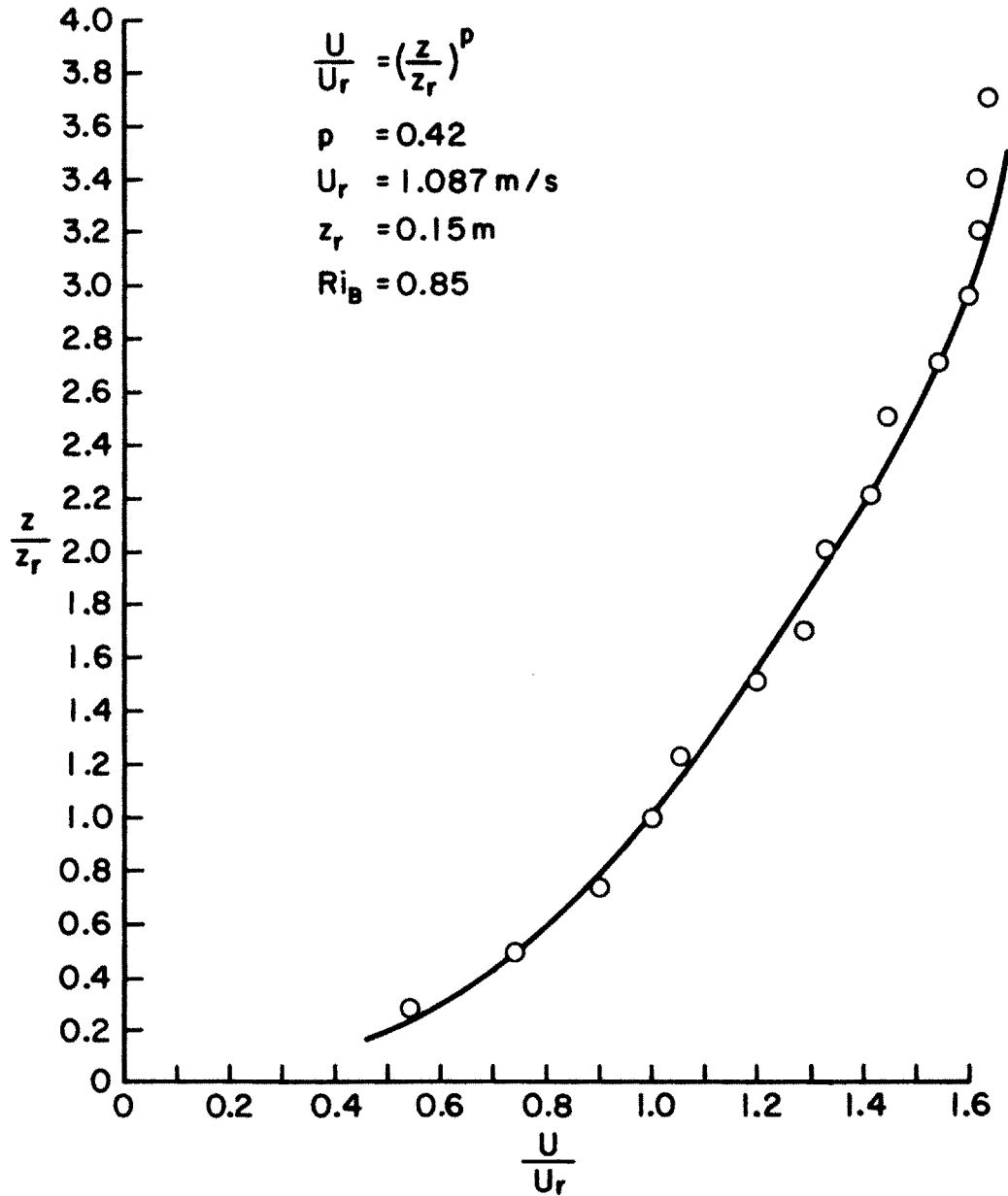

Figure 10. Velocity profile, strongly stable stratification

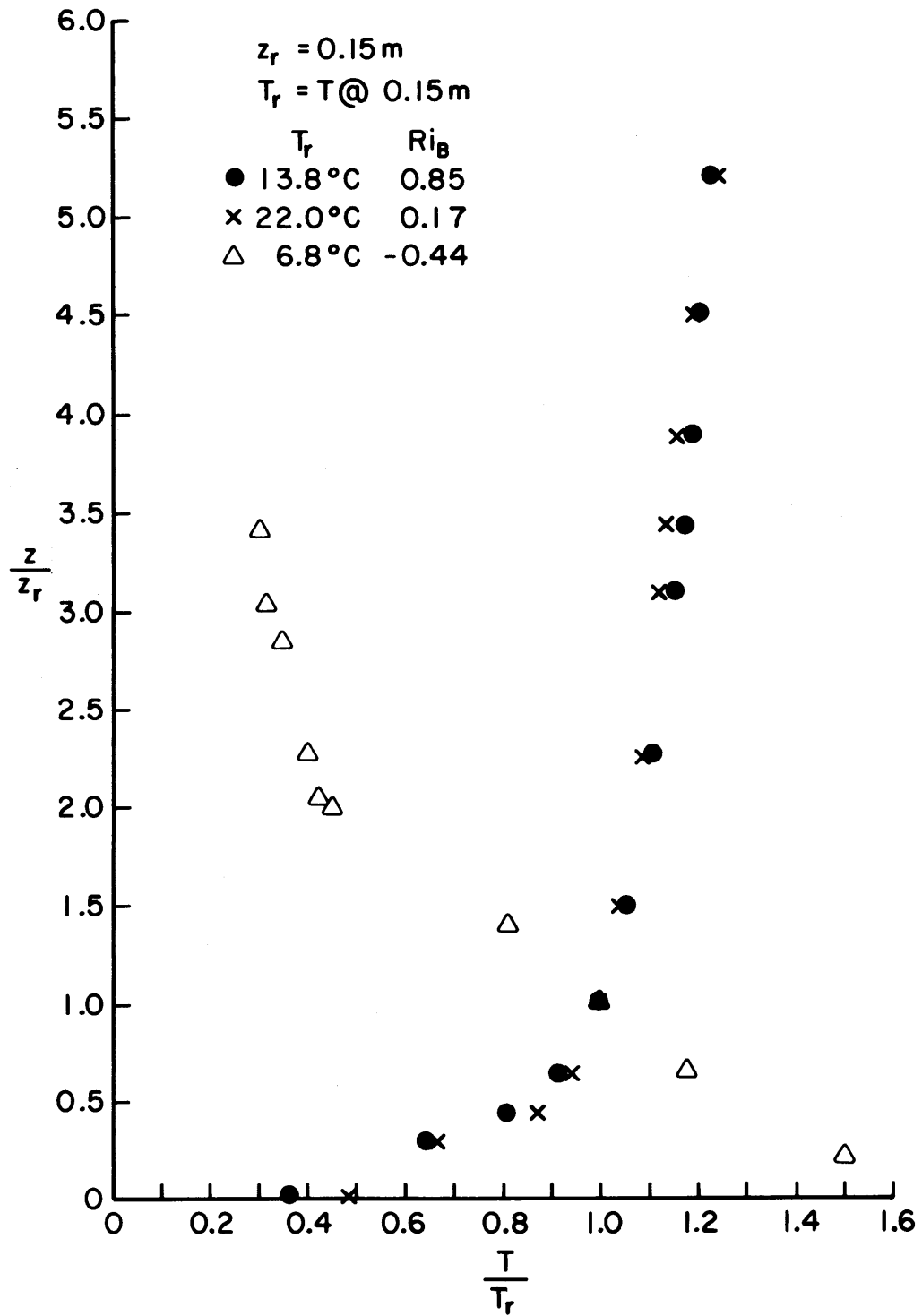

Figure 11. Temperature profiles

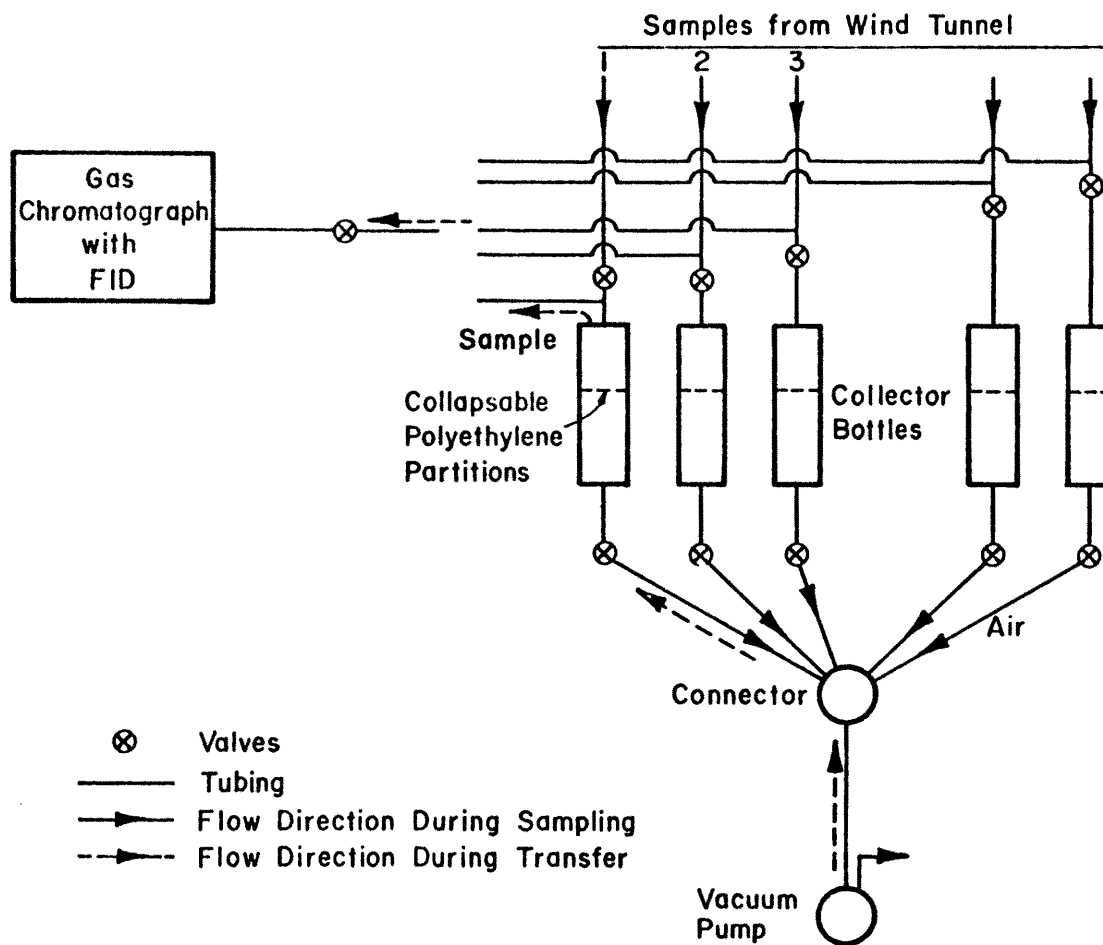

Figure 12. Tracer gas sampling and analysis system

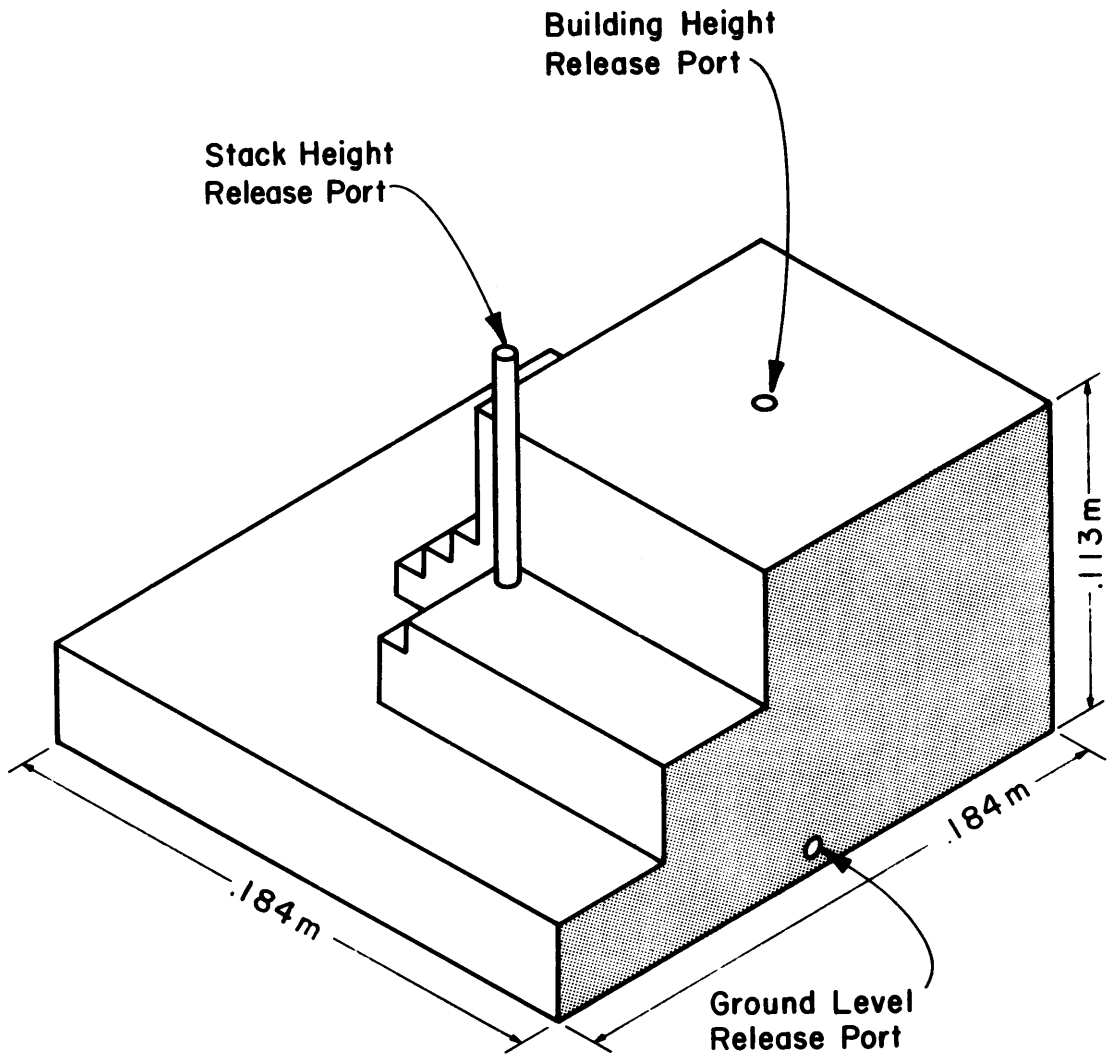

Figure 13. Model

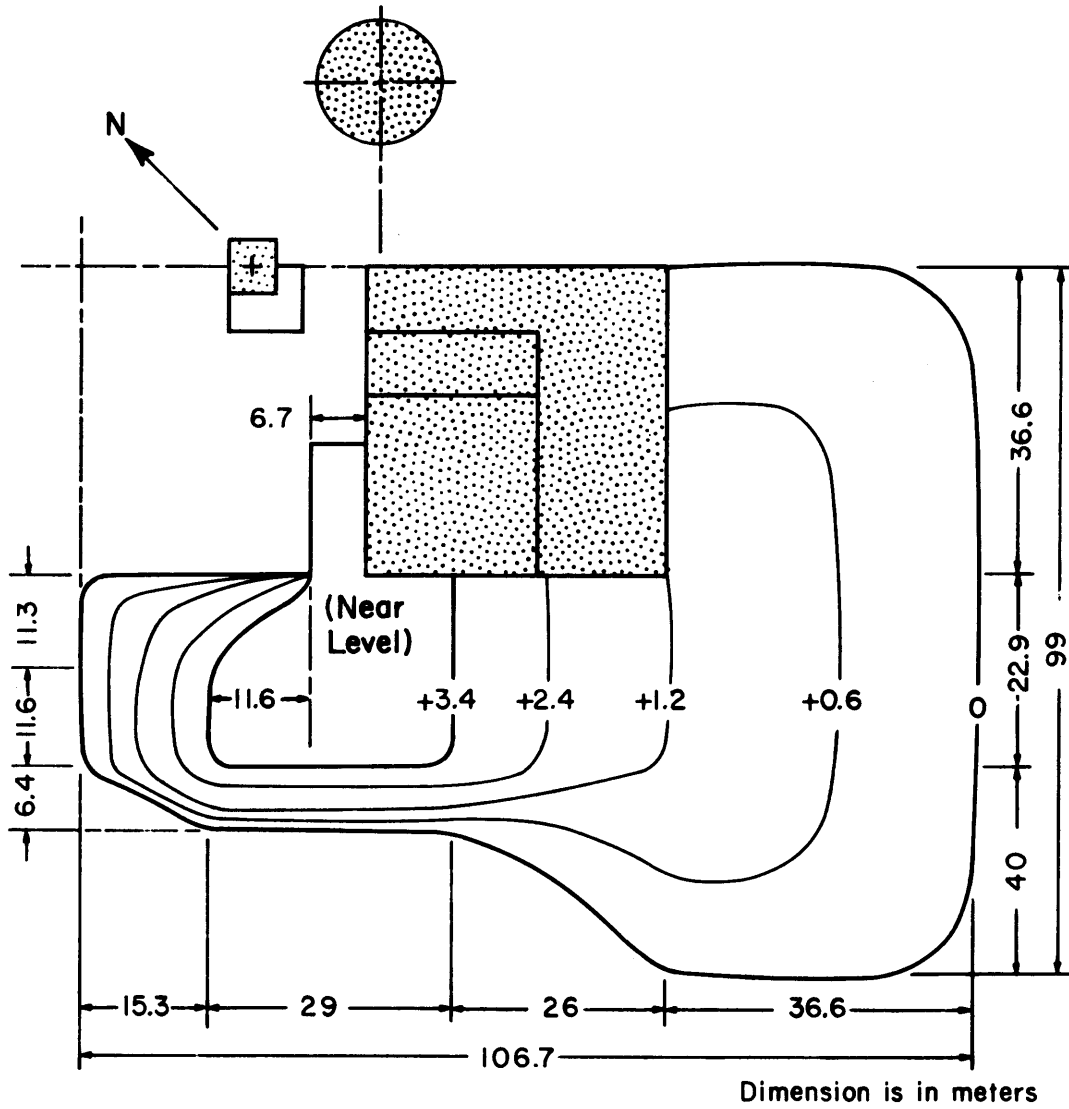

Figure 14. Sketch of building orientation and terrain

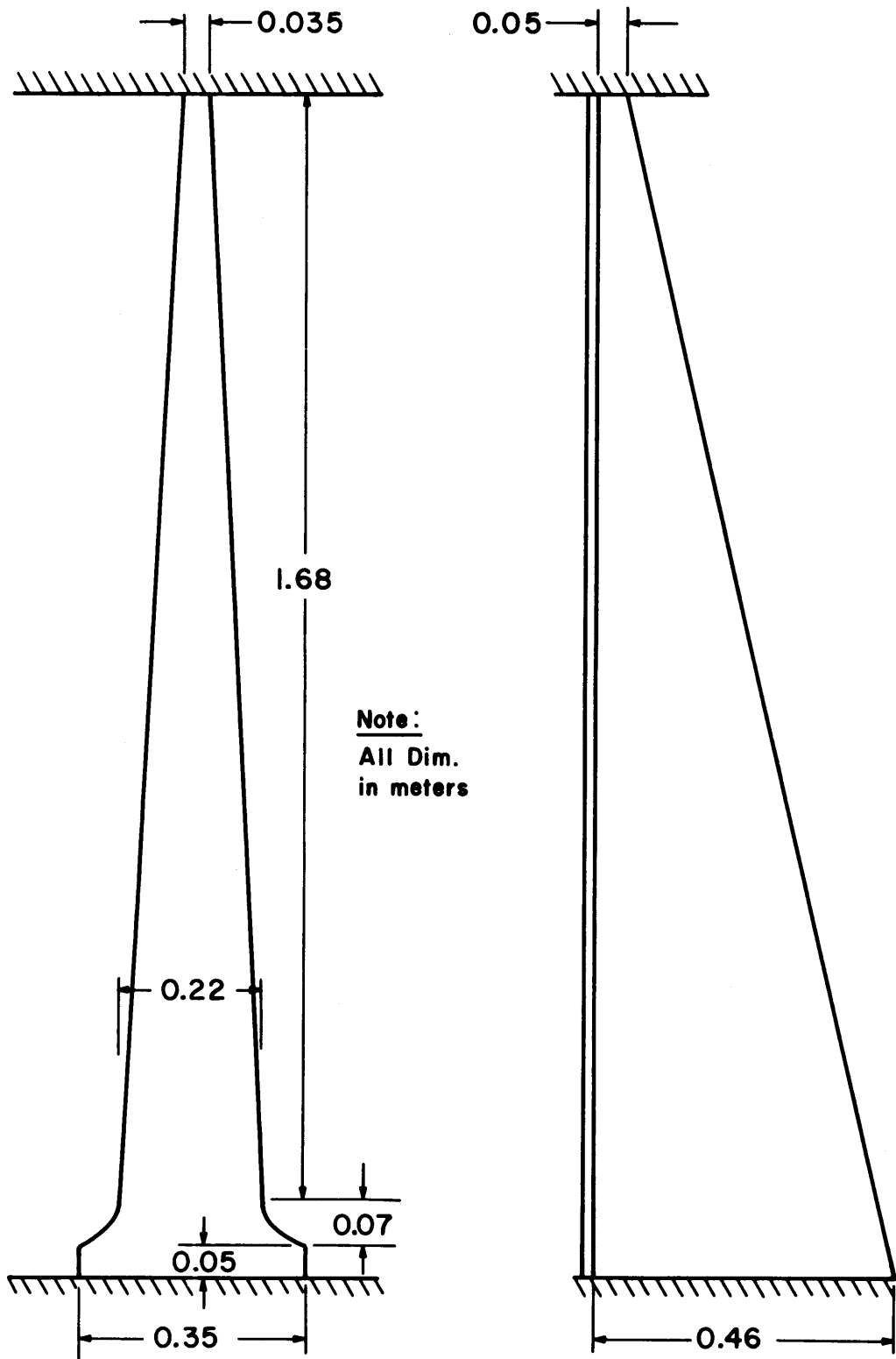

Figure 15. Spires

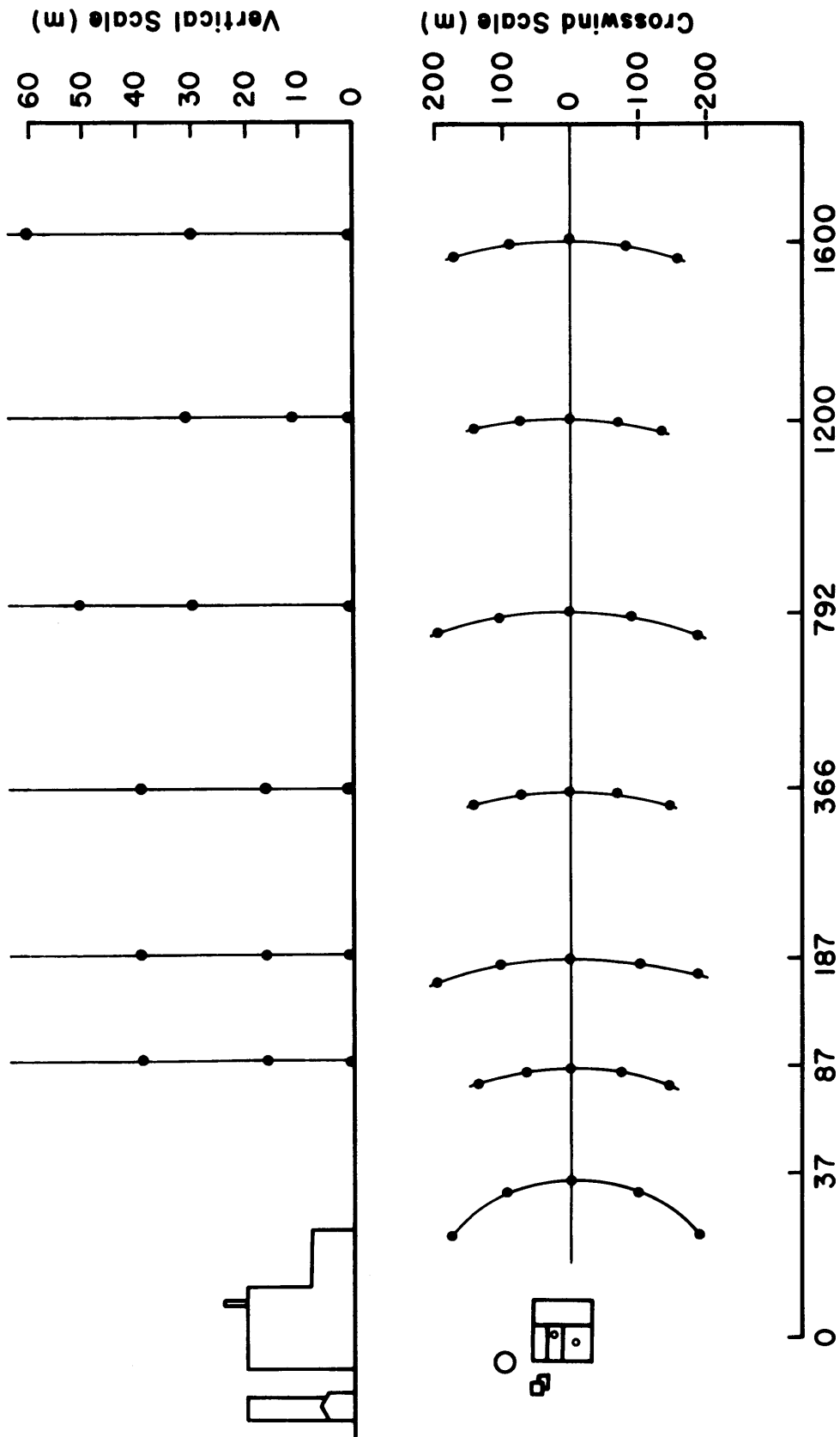

Figure 16. Sampling grid

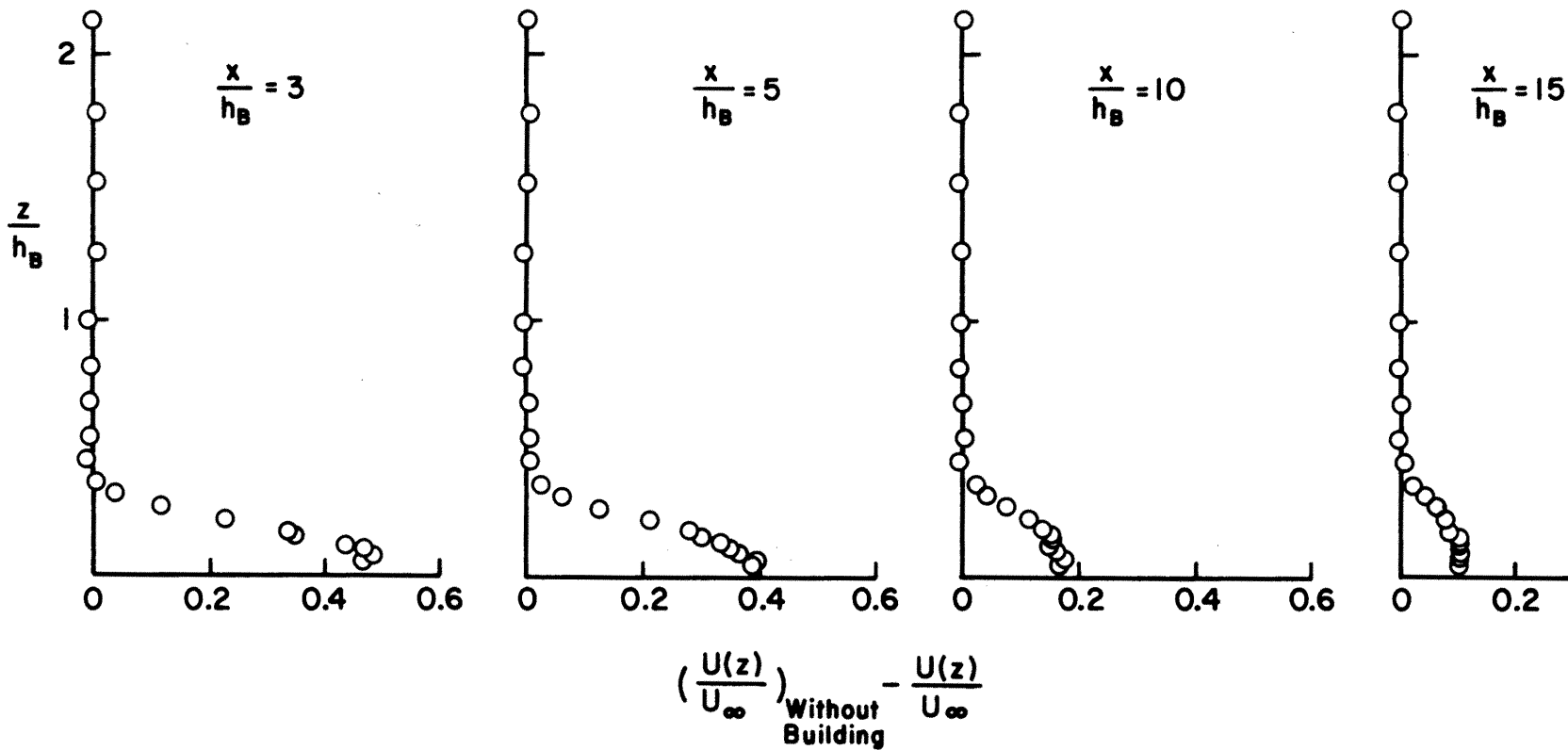

Figure 17. Centerline velocity defects, $\theta = 0^\circ$

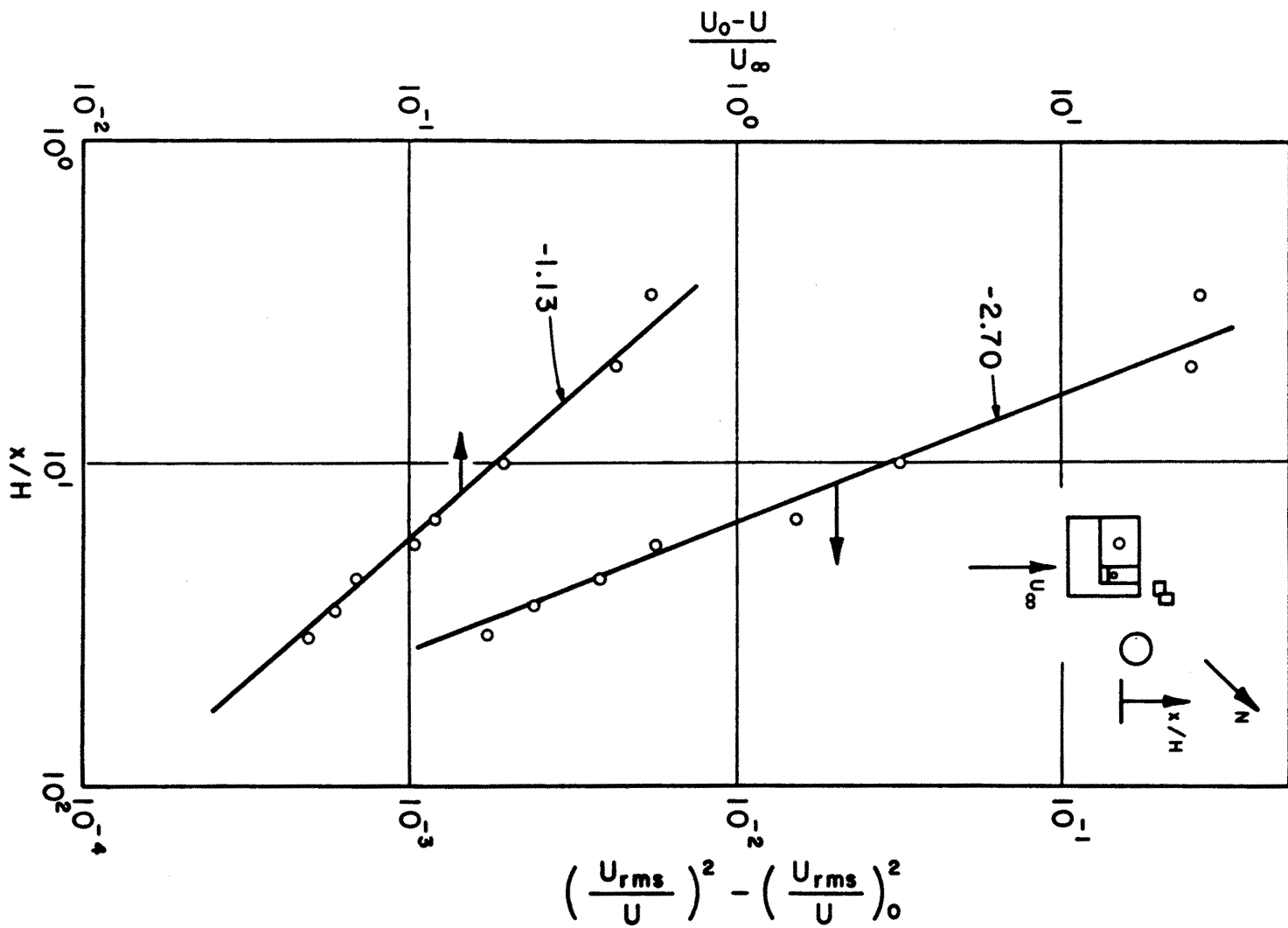
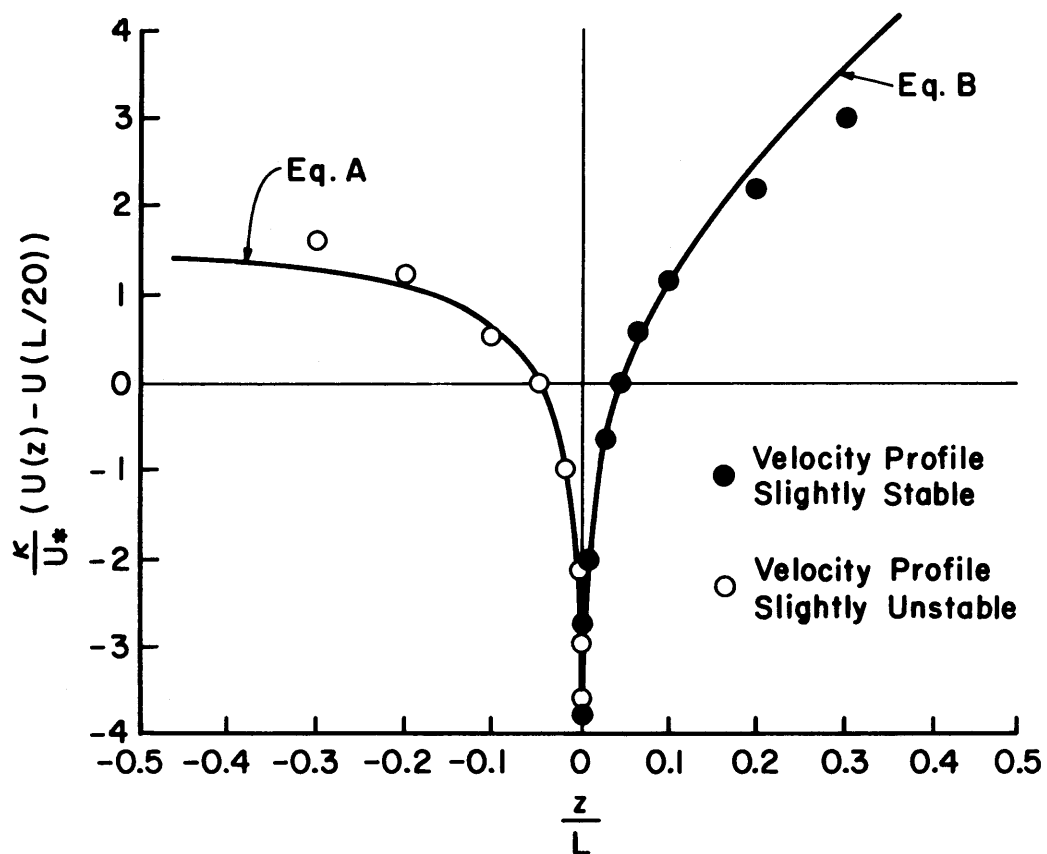

Figure 18. Decay of mean velocity defect and turbulent intensity excess



$$\text{Eq. A} \quad \frac{k}{u_*} [u(z) - u(\frac{L}{20})] = \ln(\frac{z}{L/20}) + 2(\frac{z}{L} + \frac{1}{20})$$

$$\text{Eq. B} \quad \frac{k}{u_*} [u(z) - u(\frac{L}{20})] = \ln(\frac{z}{L/20}) + 7(\frac{z}{L} - \frac{1}{20})$$

Figure 19. Comparison of velocity profiles with similarity theory

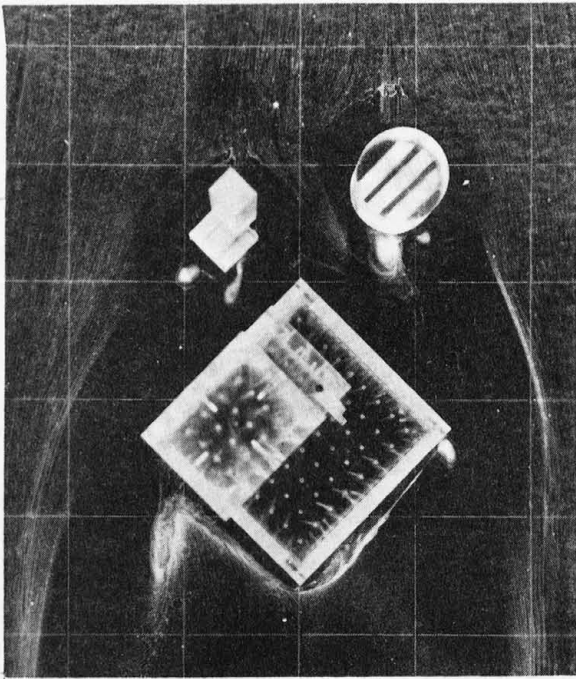

$\theta = 0^\circ$

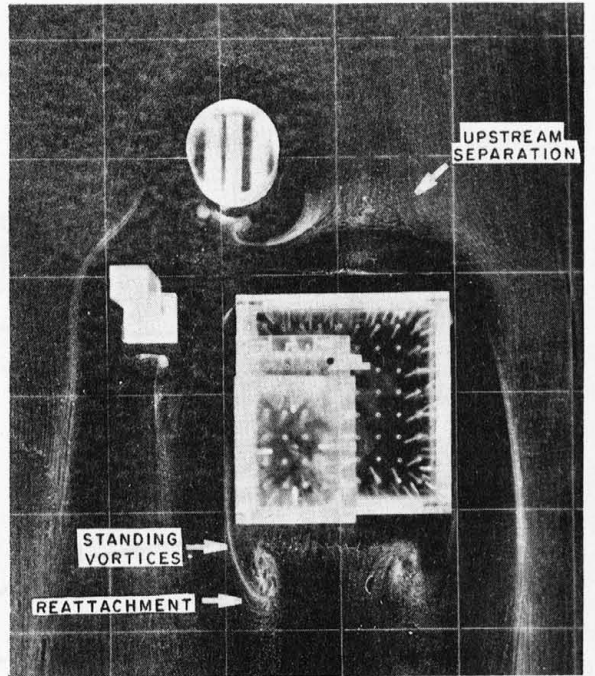

$\theta = 45^\circ$

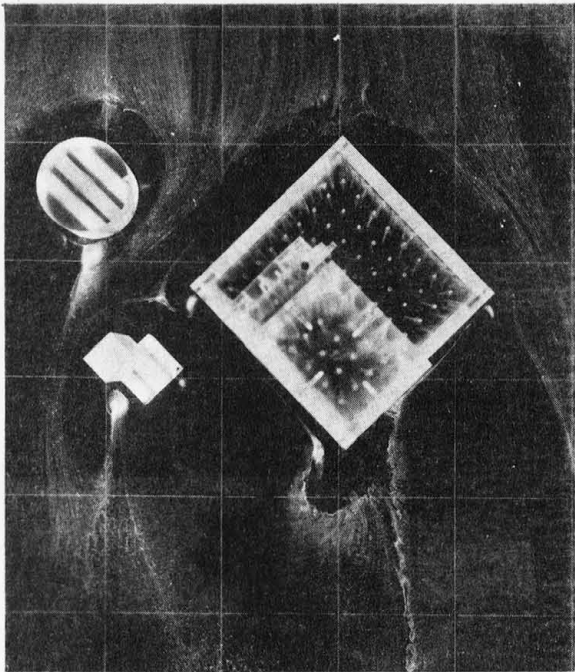

$\theta = 90^\circ$

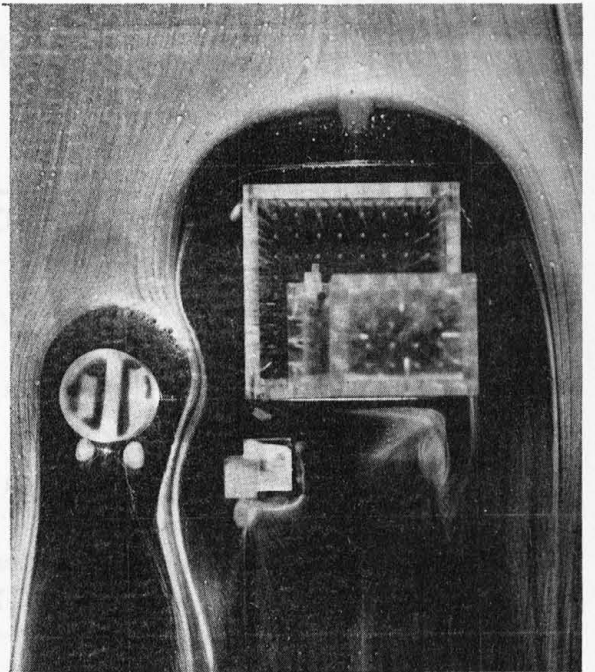

$\theta = 135^\circ$

Figure 20. Oil film pictures with silo and tank buildings present.

 $\theta = 180^\circ$  $\theta = 225^\circ$  $\theta = 270^\circ$  $\theta = 315^\circ$

Figure 20 (continued)



$\theta = 0^\circ$

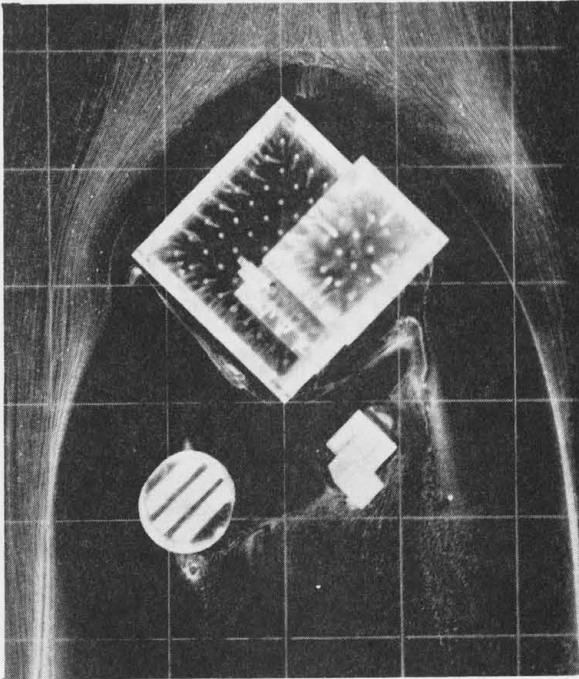
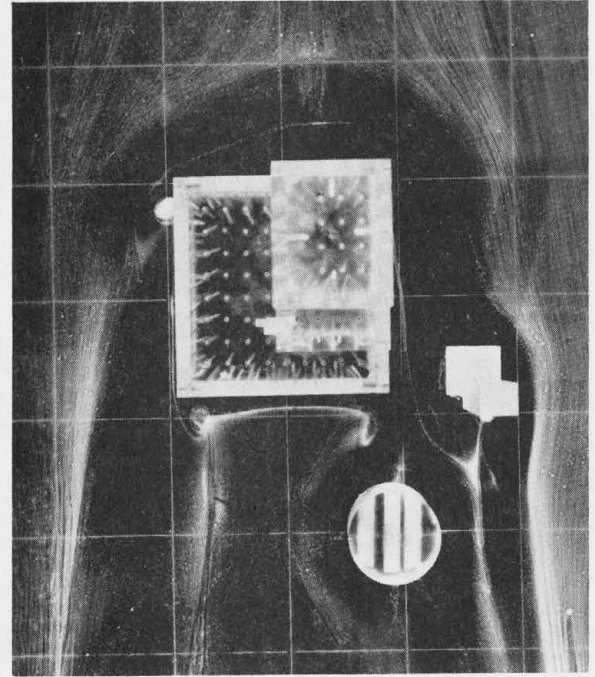
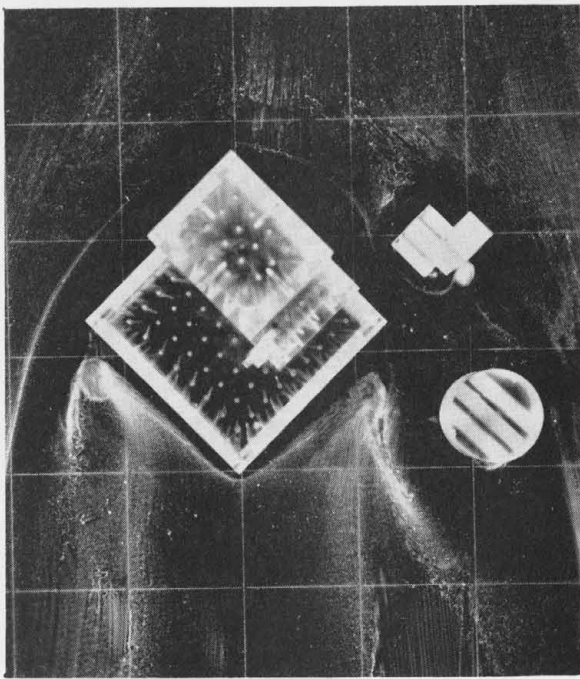
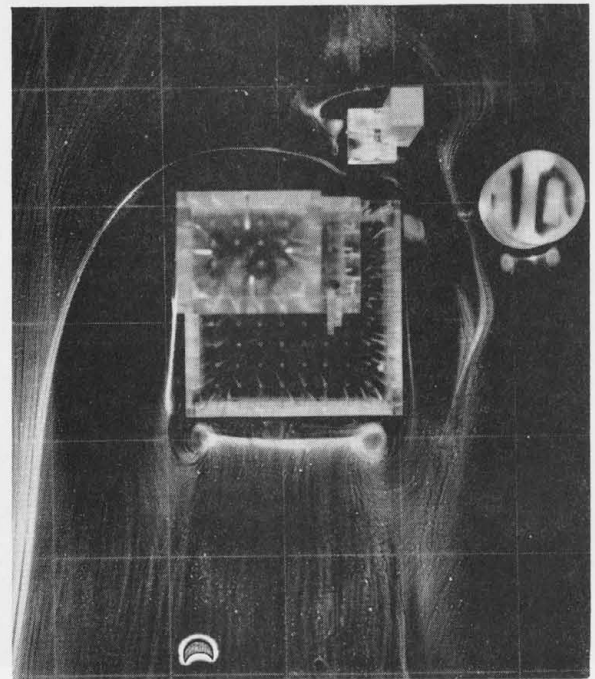
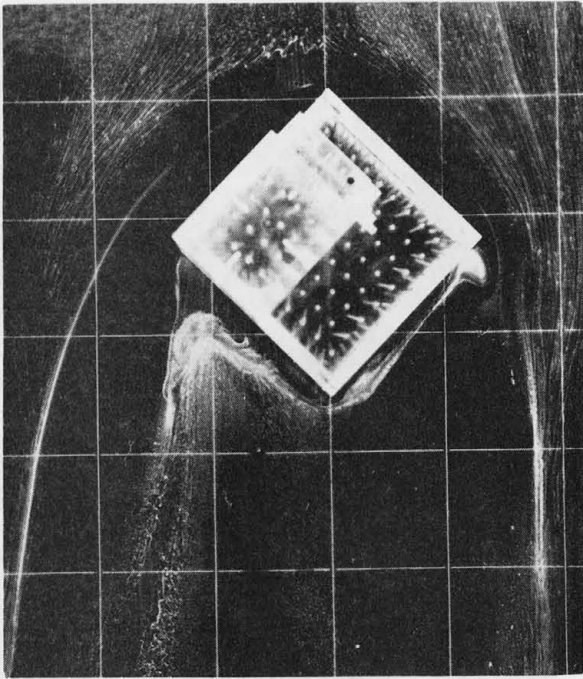
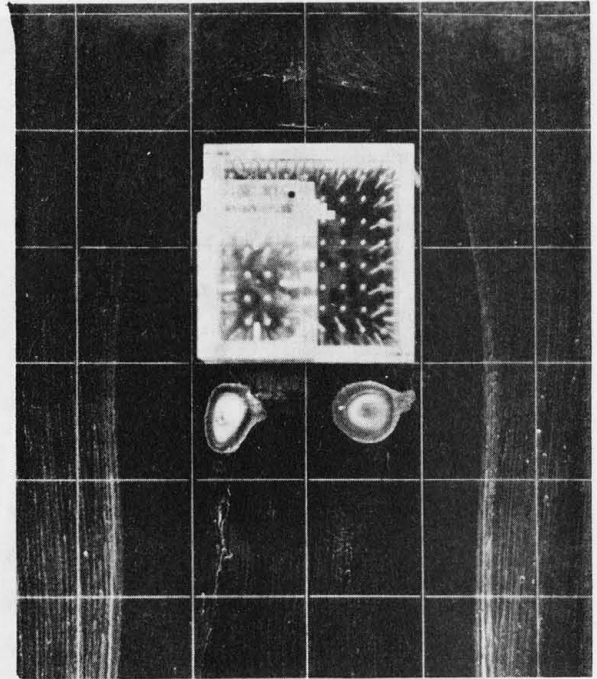

$\theta = 45^\circ$

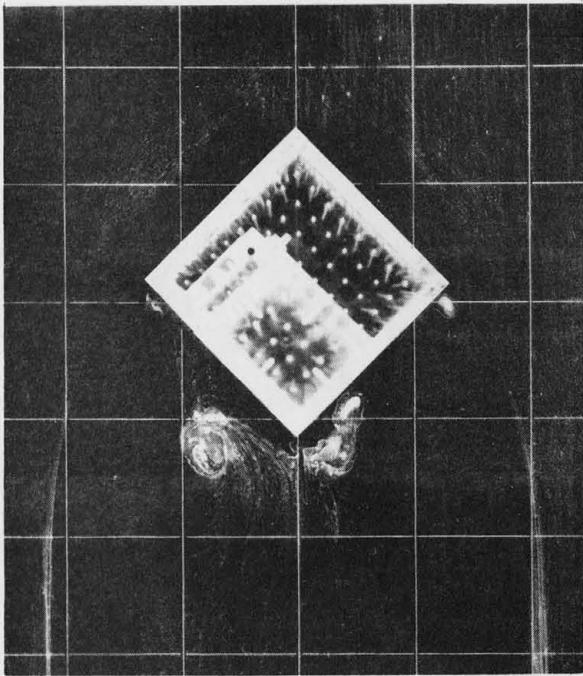

$\theta = 90^\circ$

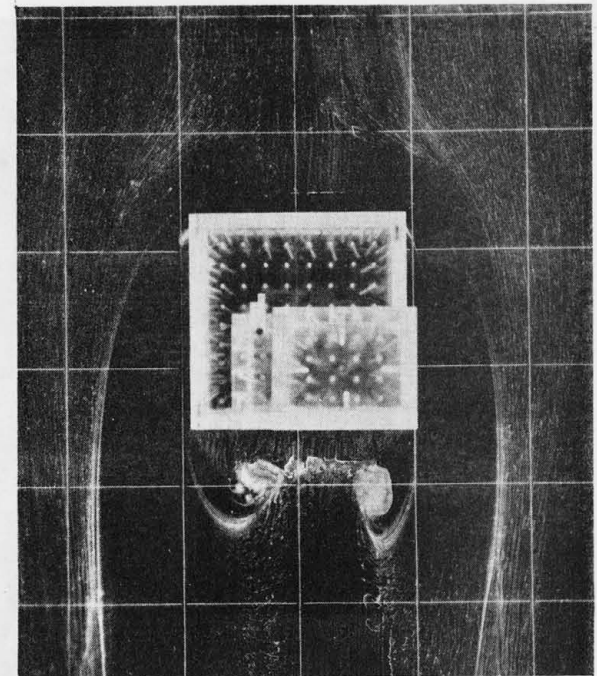

$\theta = 135^\circ$

Figure 21. Oil film pictures without silo and tank buildings present.

 $\theta = 180^\circ$  $\theta = 225^\circ$  $\theta = 270^\circ$  $\theta = 315^\circ$

Figure 21 (continued)



$\theta = 0^\circ$

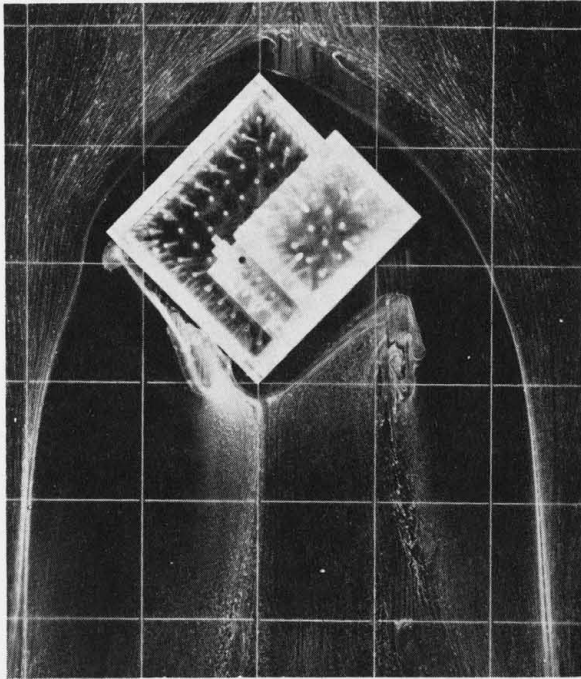
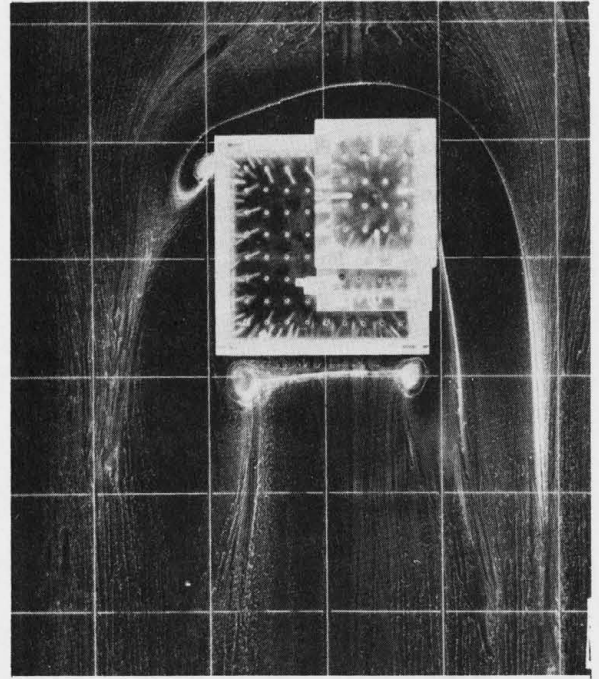
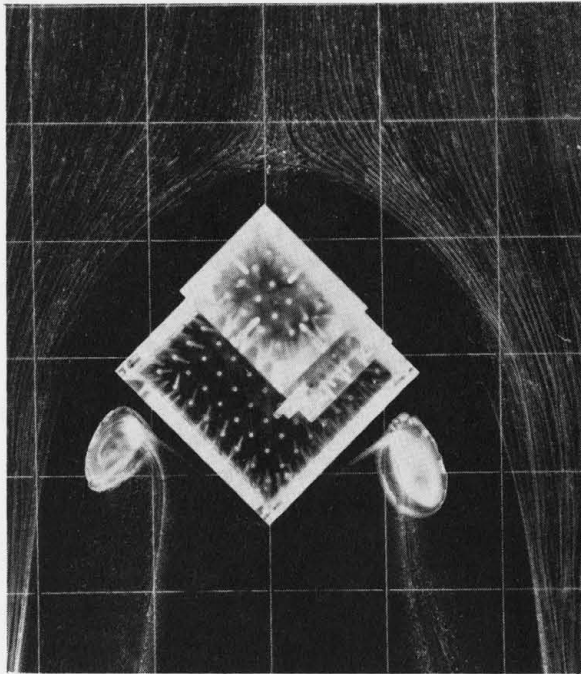
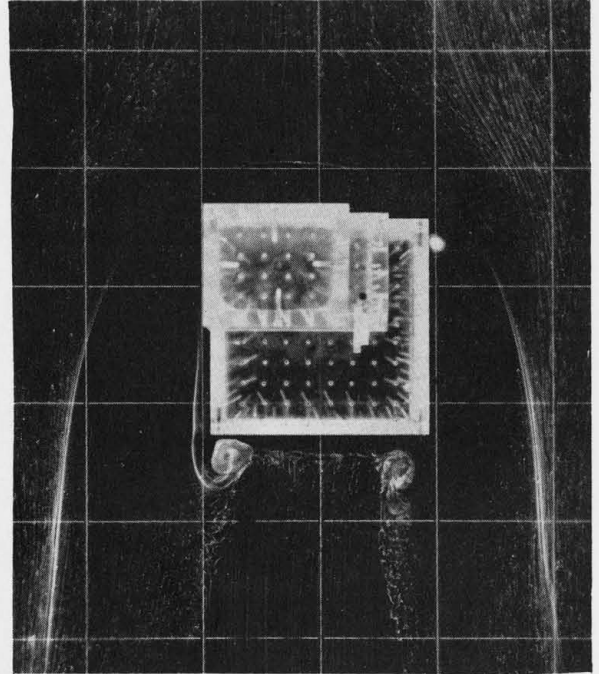
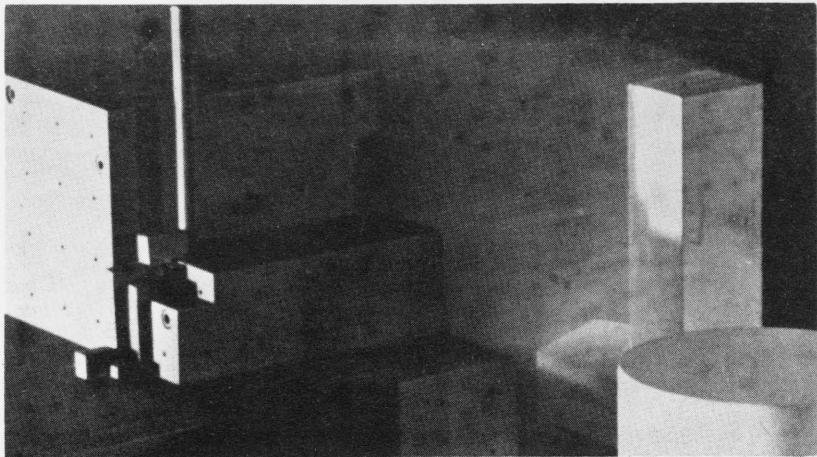

$\theta = 45^\circ$

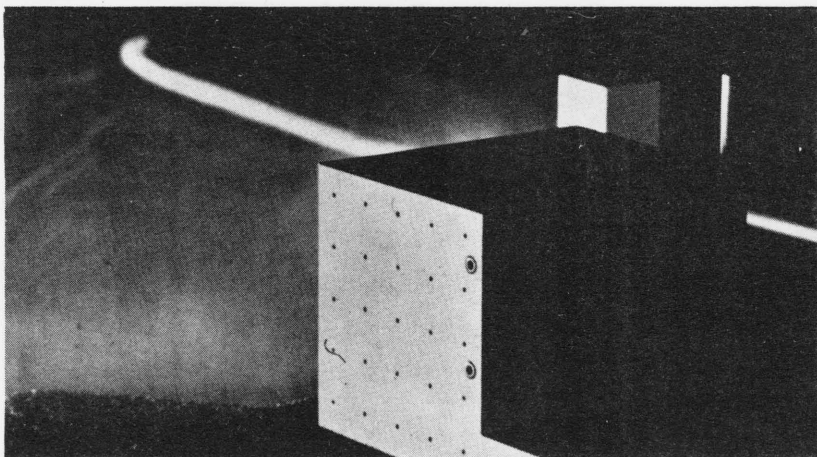

$\theta = 90^\circ$

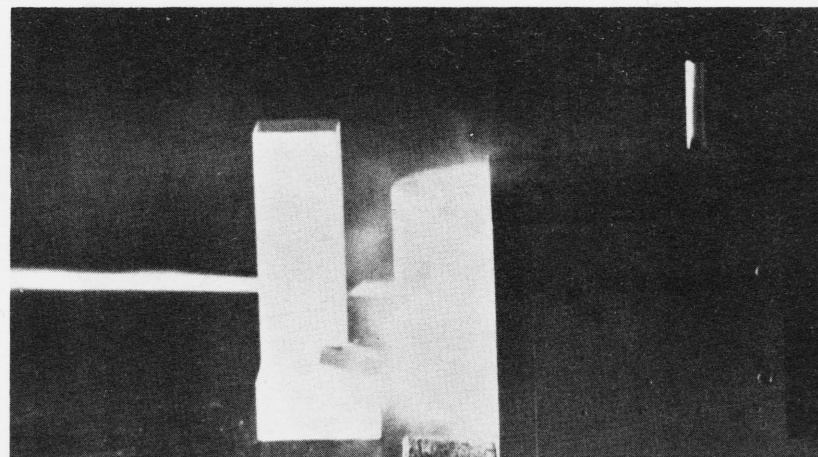

$\theta = 135^\circ$

Figure 22a. Ground level release smoke visualization, neutral.

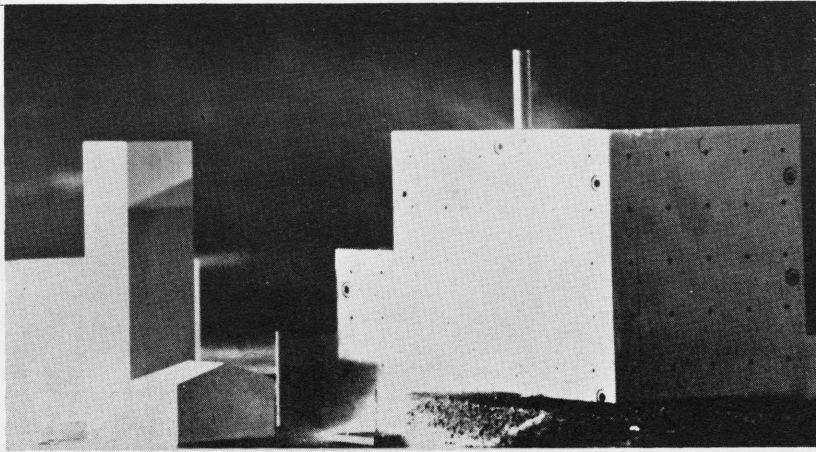

$\theta = 180^\circ$

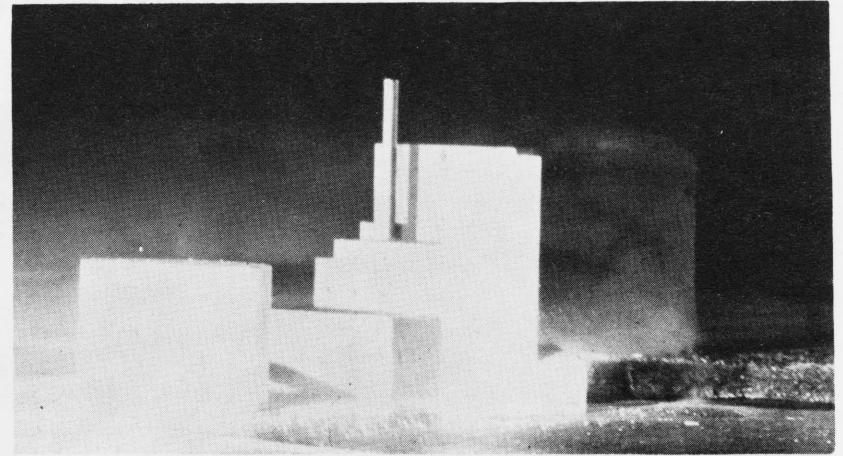

$\theta = 225^\circ$

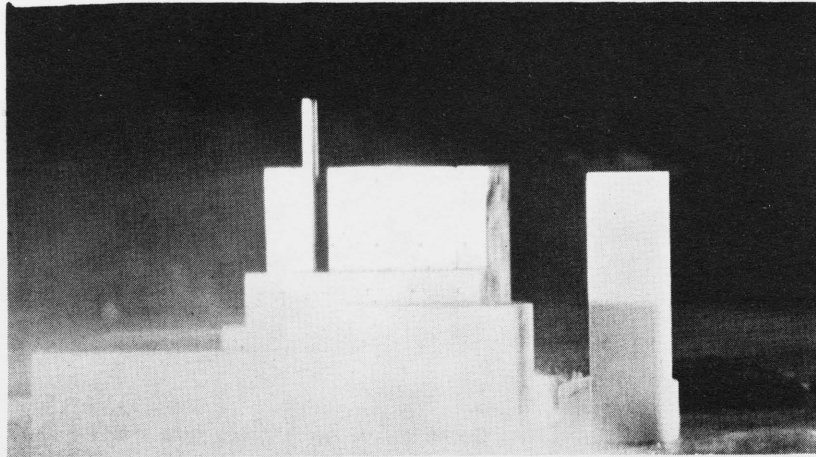

$\theta = 270^\circ$

Figure 22a (continued).

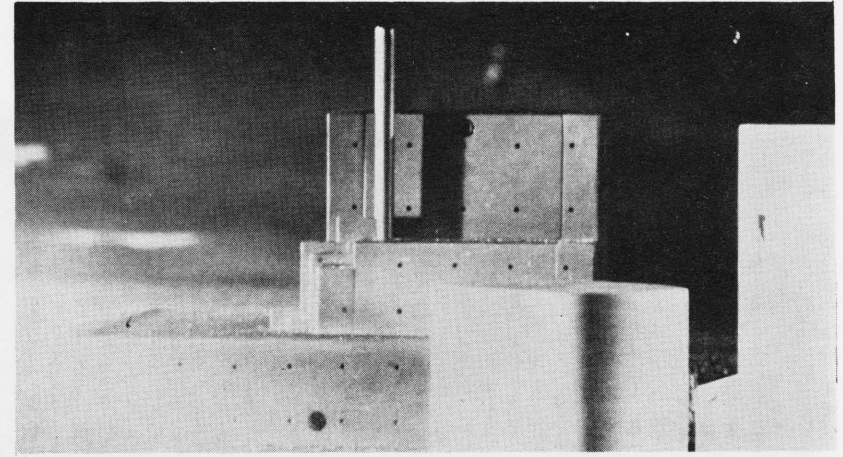

$\theta = 315^\circ$

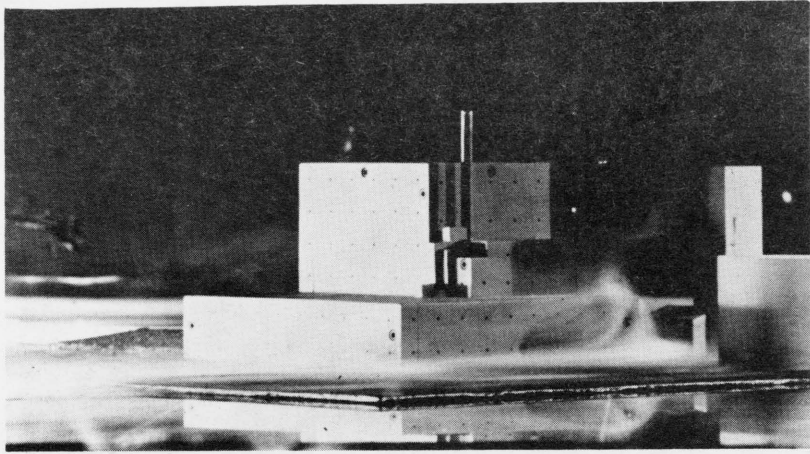

$\theta = 0^\circ$

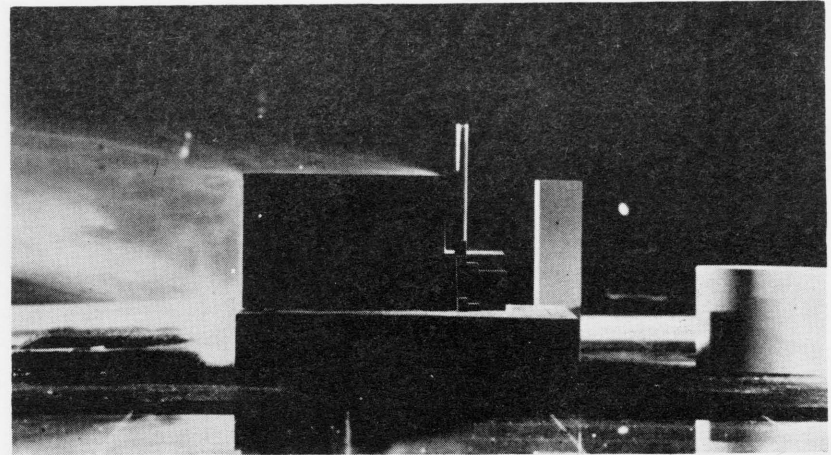

$\theta = 45^\circ$

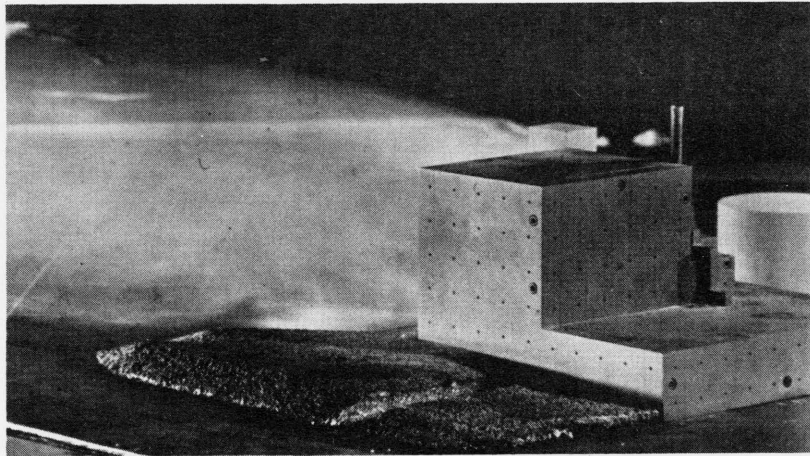

$\theta = 90^\circ$

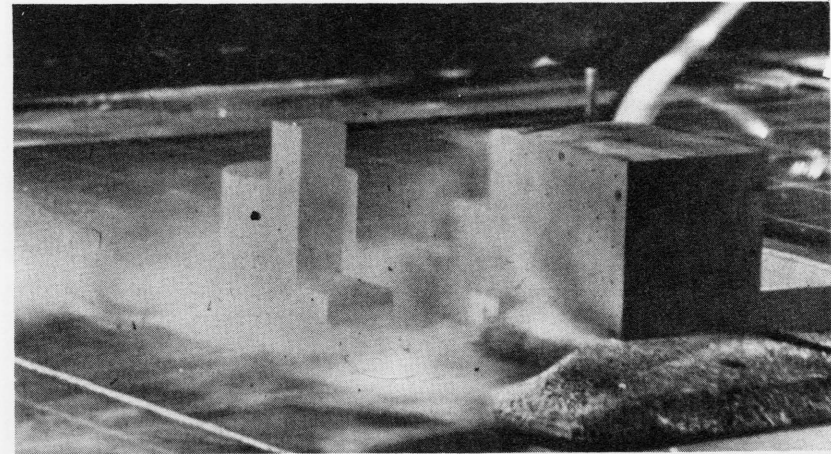

$\theta = 135^\circ$

Figure 22b. Ground level release smoke visualization, stable.

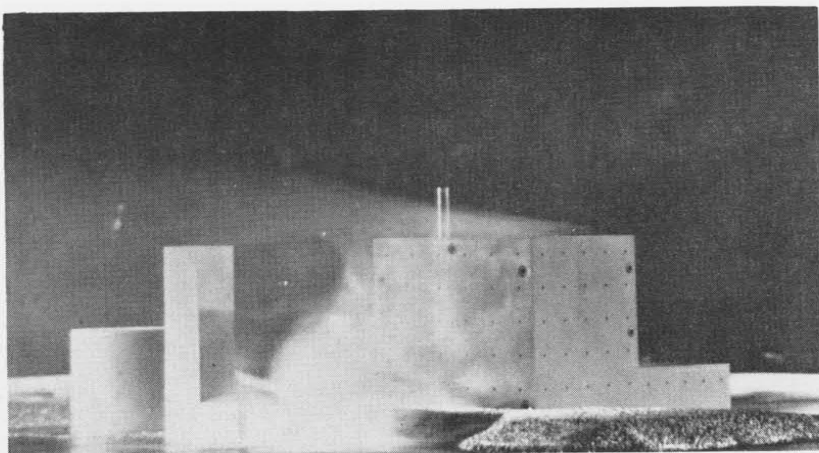

$\theta = 180^\circ$

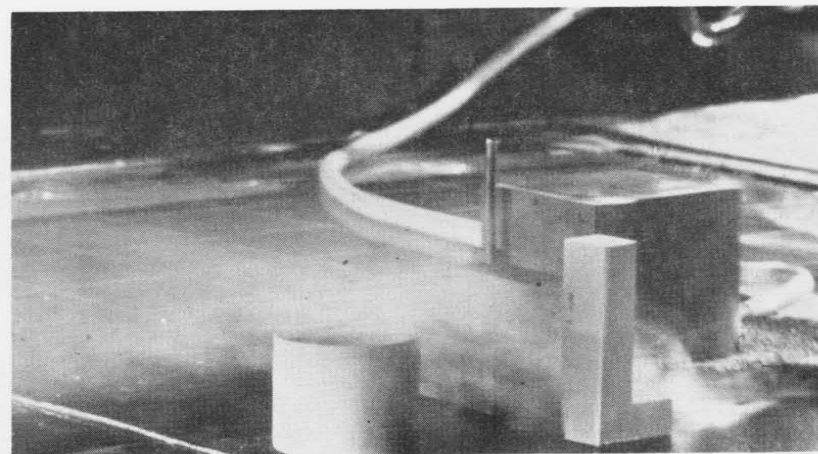

$\theta = 225^\circ$

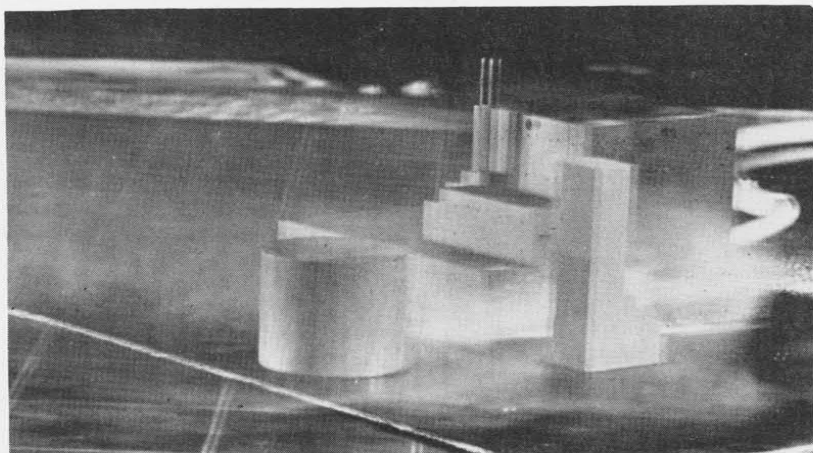

$\theta = 270^\circ$

Figure 22b (continued).

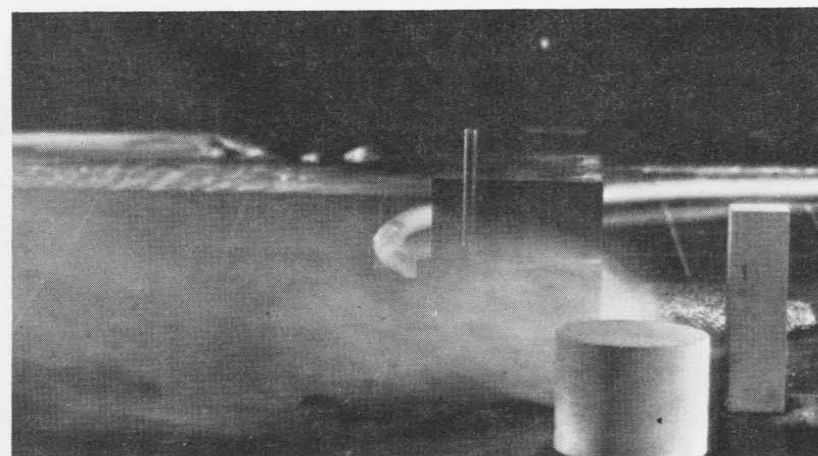

$\theta = 315^\circ$

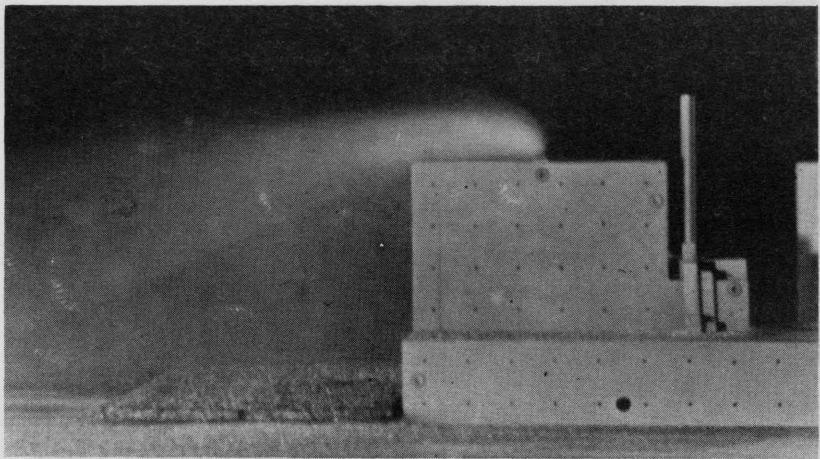

$\theta = 0^\circ$

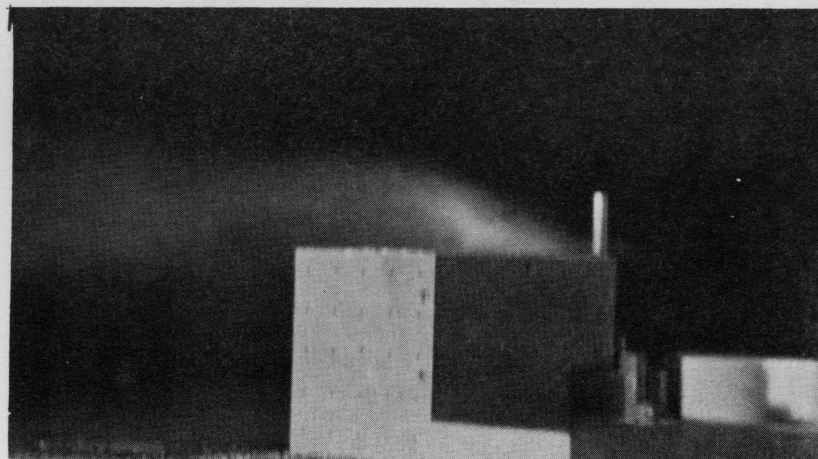

$\theta = 45^\circ$

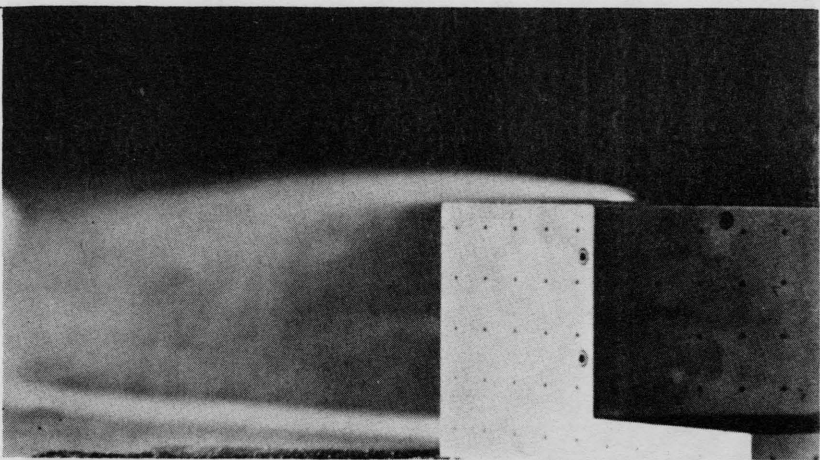

$\theta = 90^\circ$

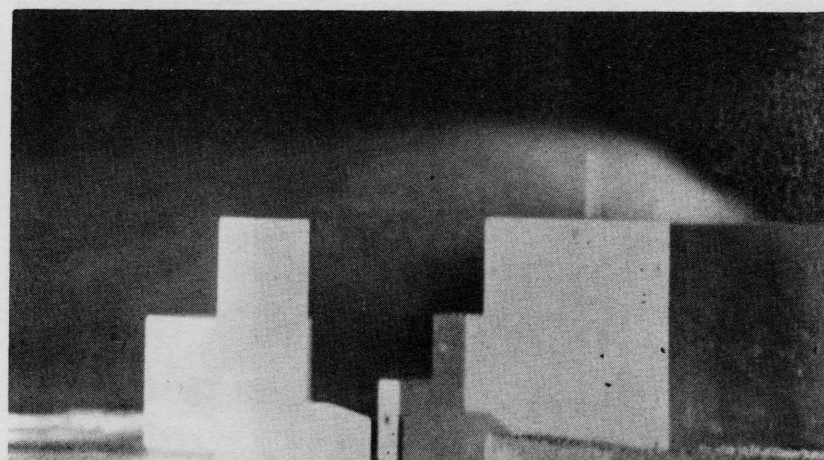

$\theta = 135^\circ$

Figure 23a. Building height release smoke visualization, neutral.

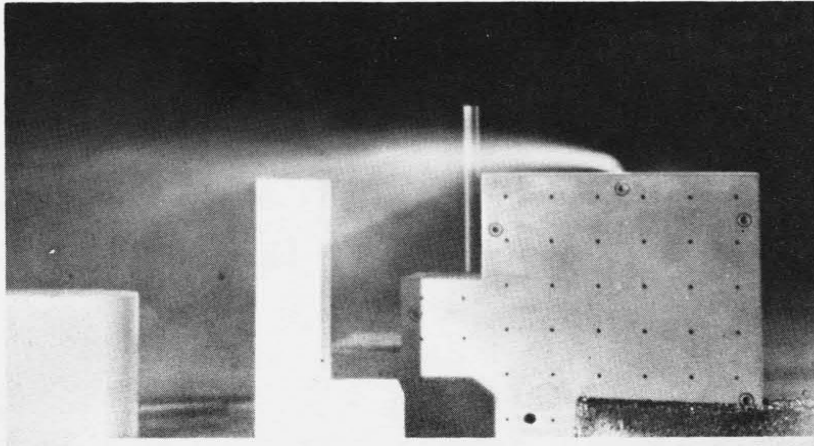

$\theta = 180^\circ$

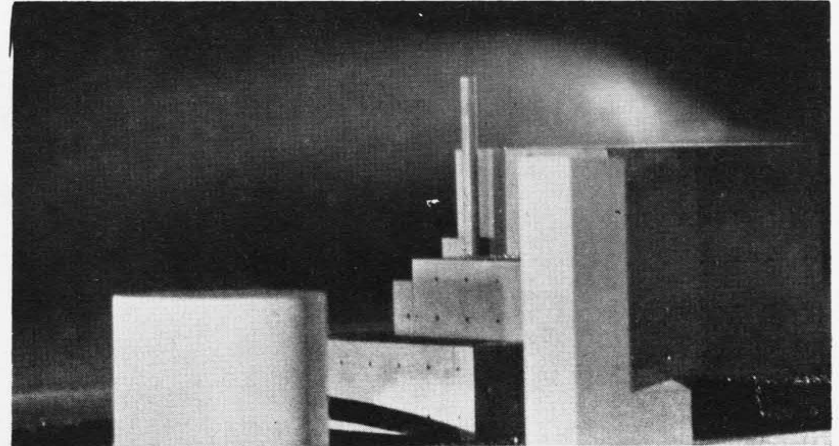

$\theta = 225^\circ$

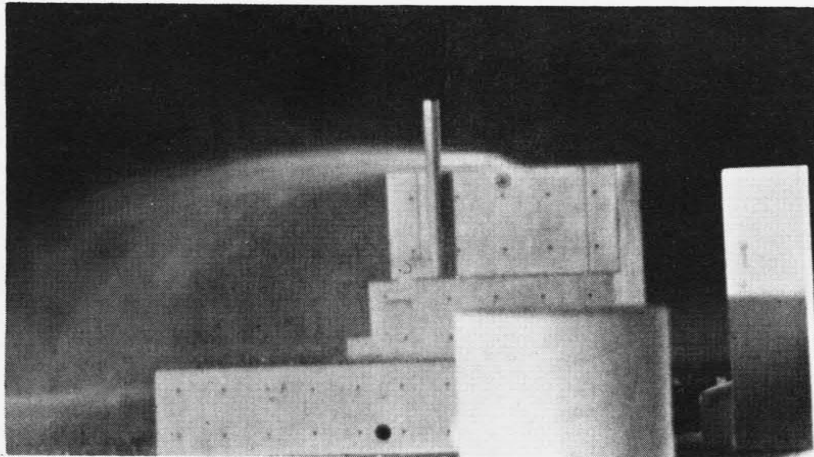

$\theta = 270^\circ$

Figure 23a (continued).

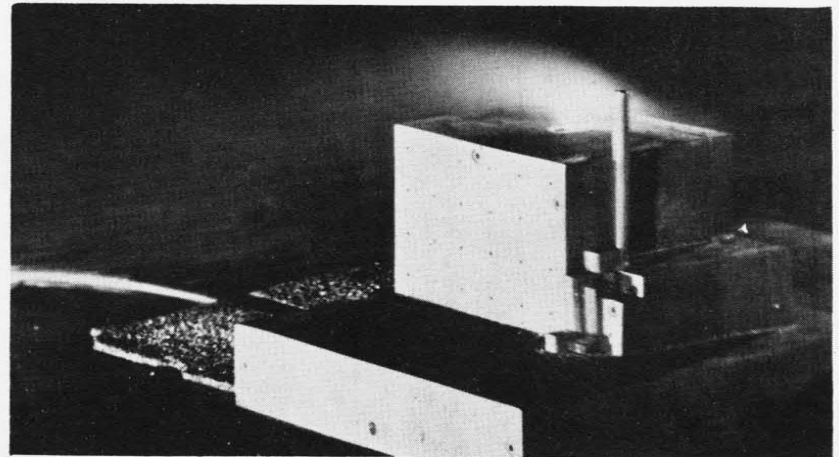

$\theta = 315^\circ$

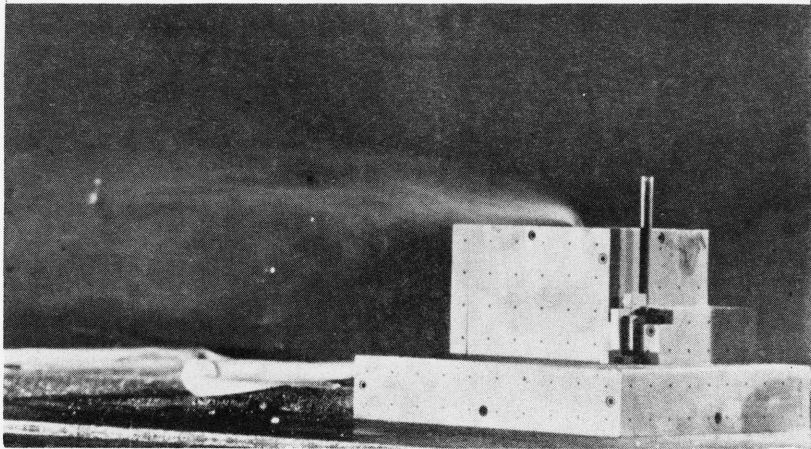

$\theta = 0^\circ$



$\theta = 45^\circ$

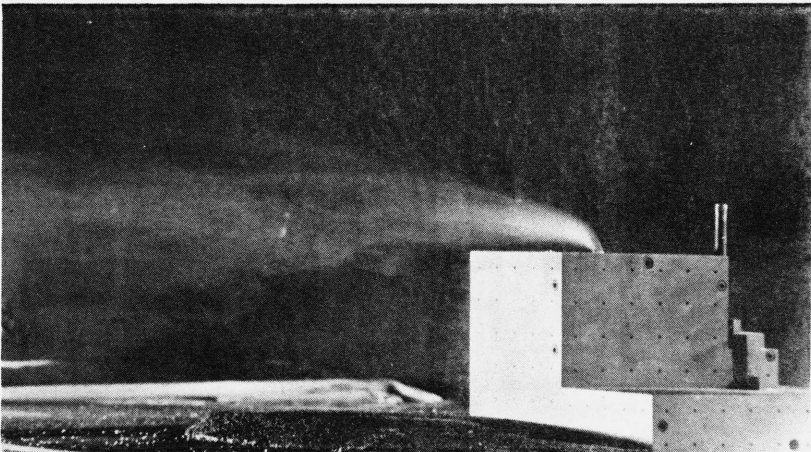

$\theta = 90^\circ$

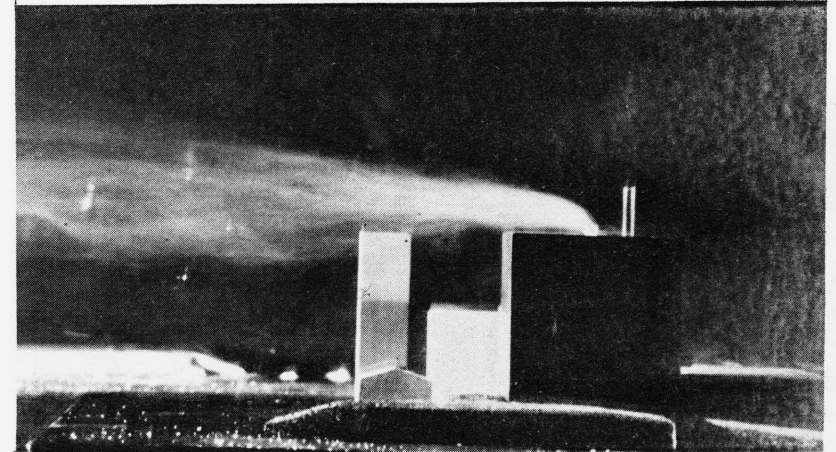

$\theta = 135^\circ$

Figure 23b. Building height release smoke visualization, stable.

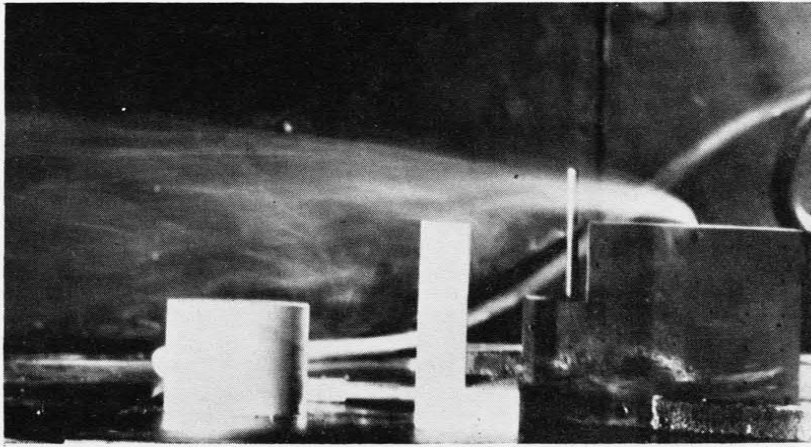

$\theta = 180^\circ$

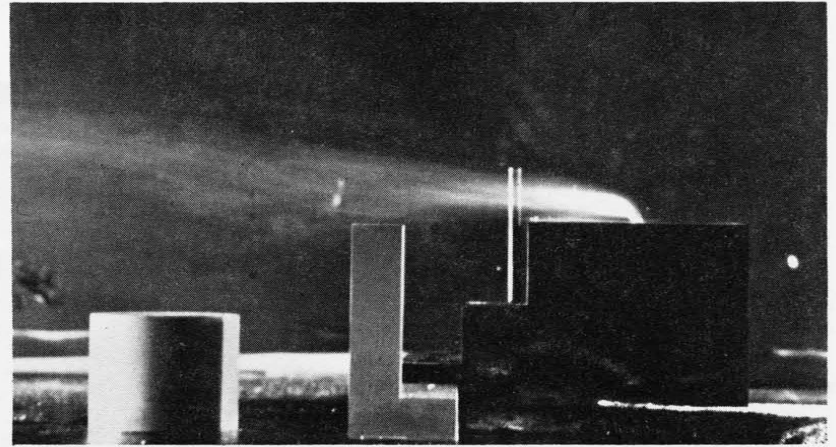

$\theta = 225^\circ$

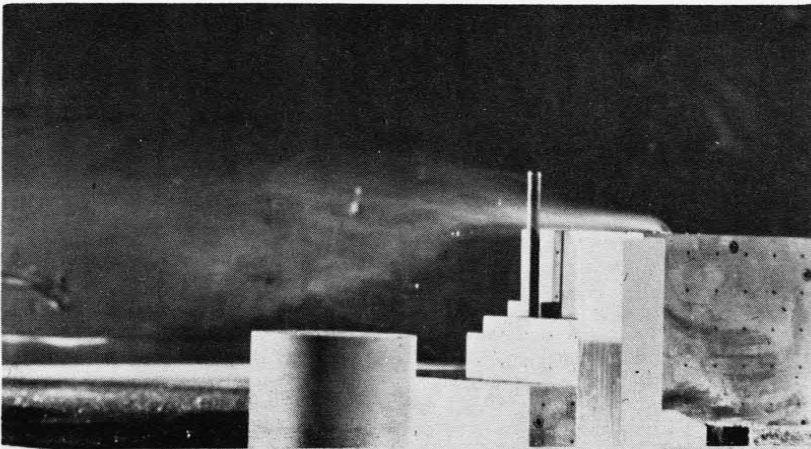

$\theta = 270^\circ$

Figure 23b (continued).

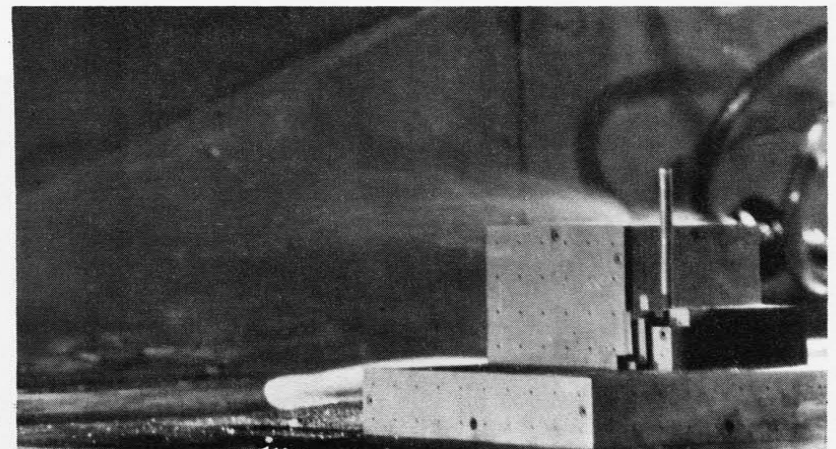

$\theta = 315^\circ$

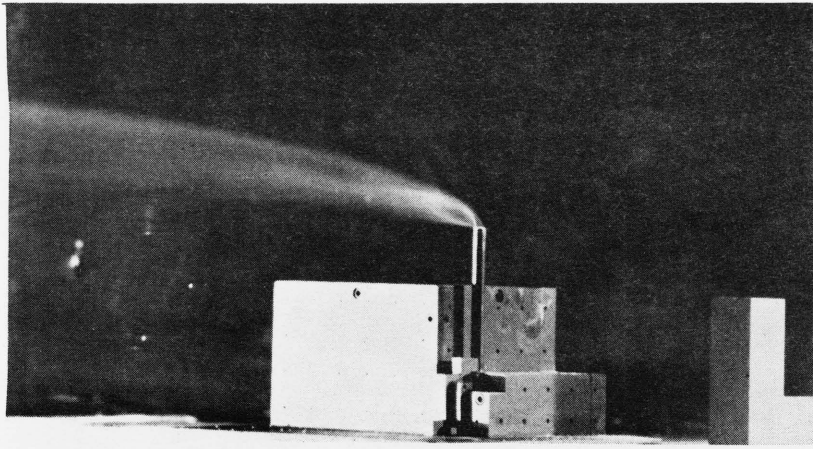

$\theta = 0^\circ$

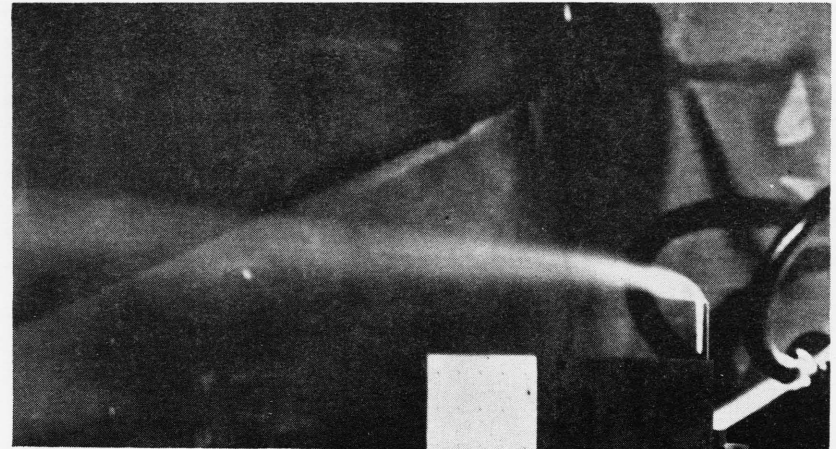

$\theta = 45^\circ$

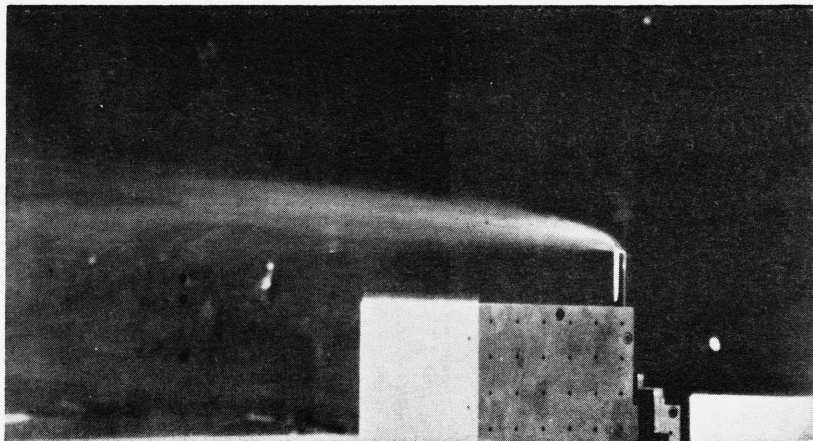

$\theta = 90^\circ$

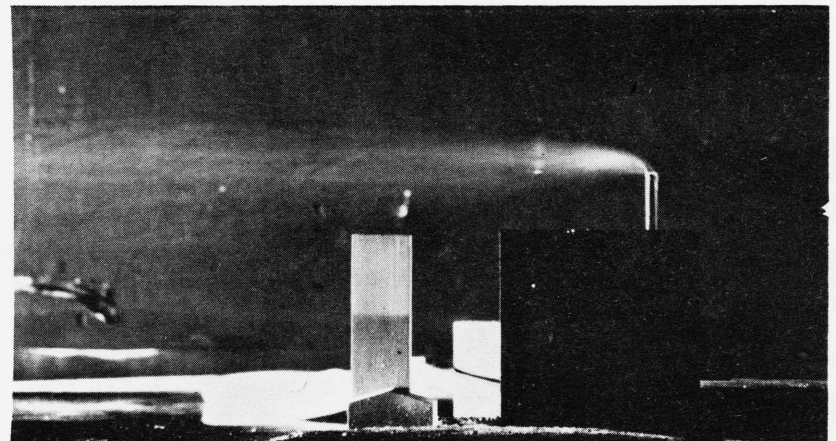

$\theta = 135^\circ$

Figure 24a. Stack height release smoke visualization, neutral.

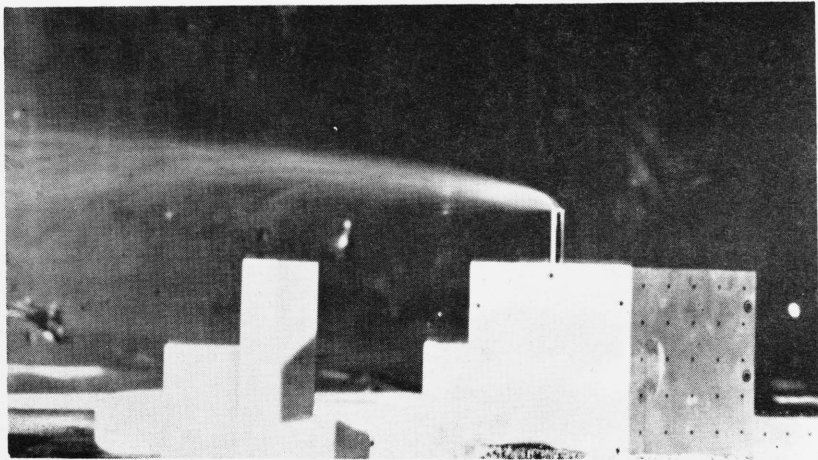

$\theta = 180^\circ$

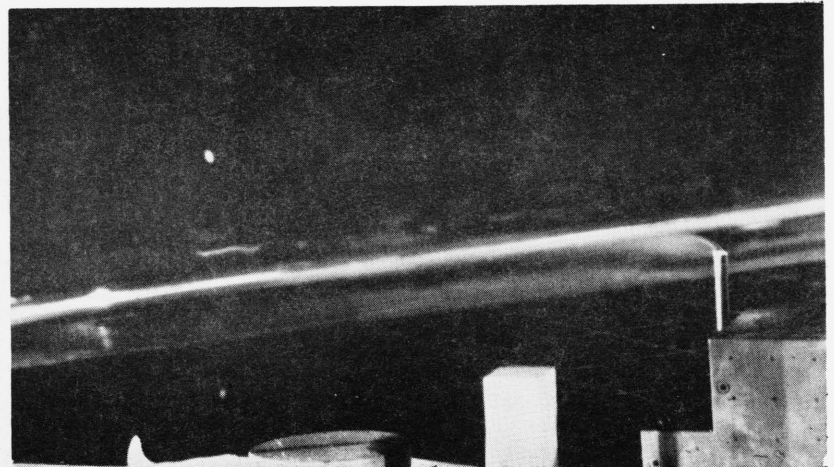

$\theta = 225^\circ$

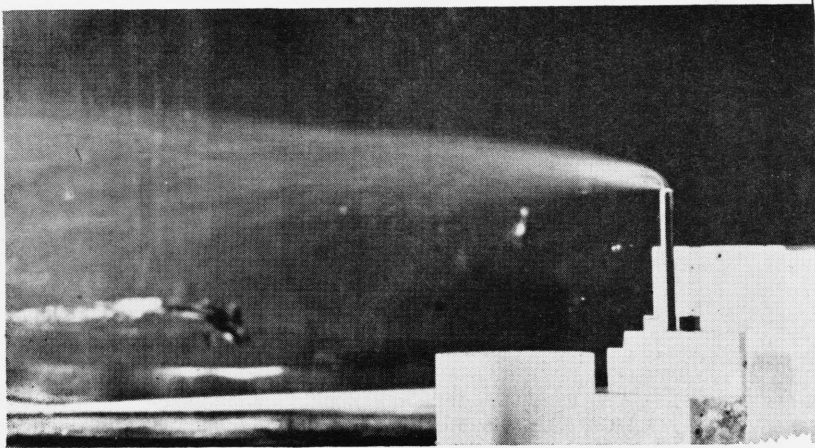

$\theta = 270^\circ$

Figure 24a (continued).

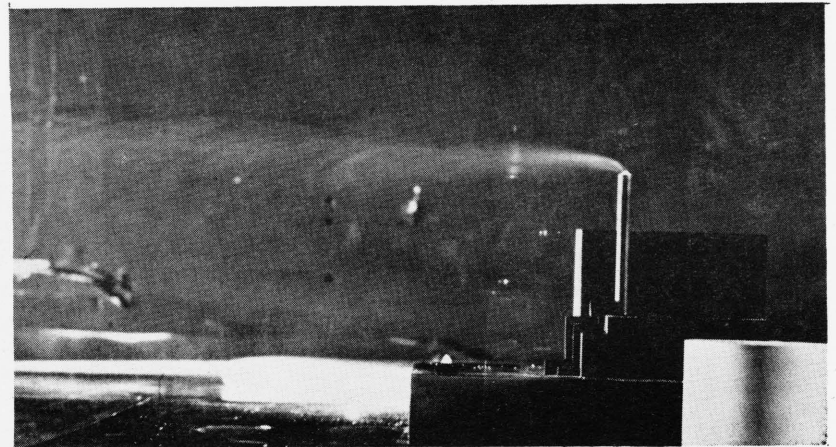

$\theta = 315^\circ$

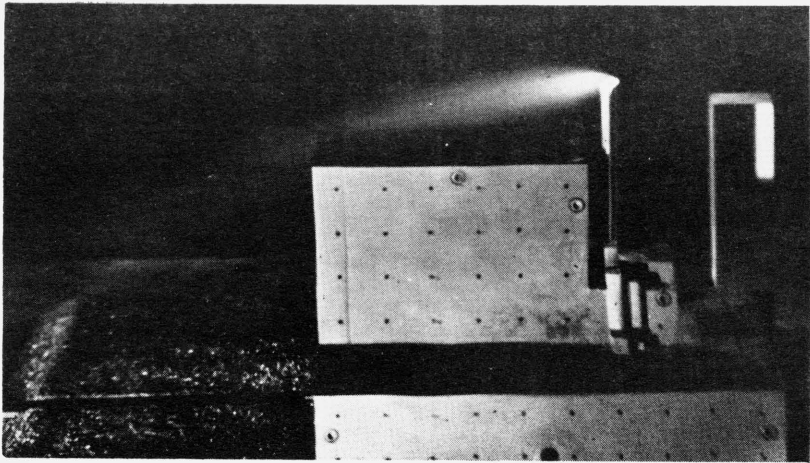

$\theta = 0^\circ$

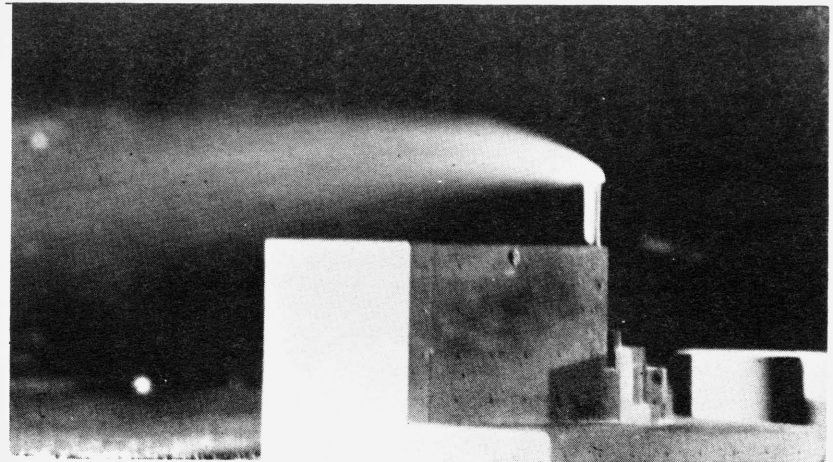

$\theta = 45^\circ$

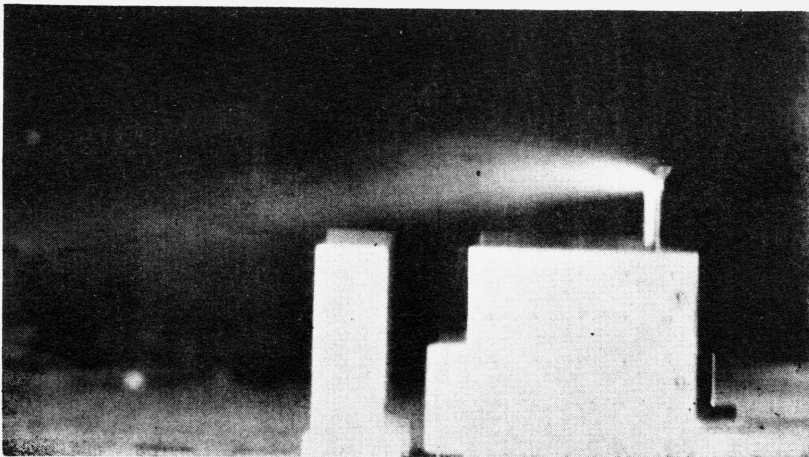

$\theta = 90^\circ$

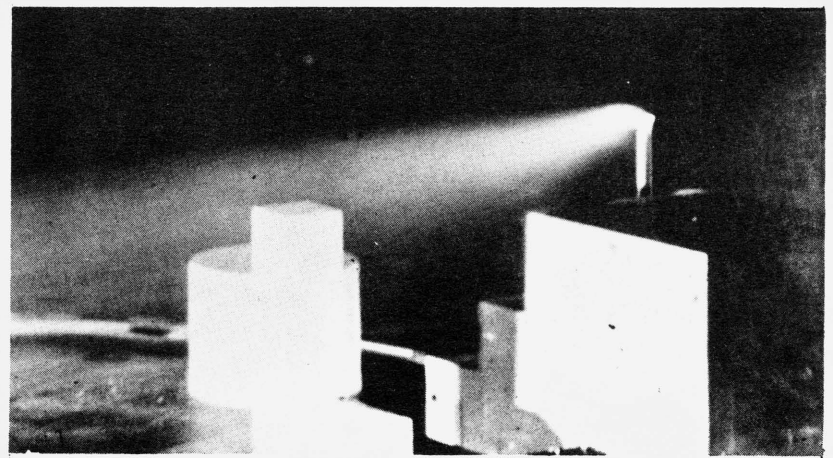

$\theta = 135^\circ$

Figure 24b. Stack height release smoke visualization, stable.

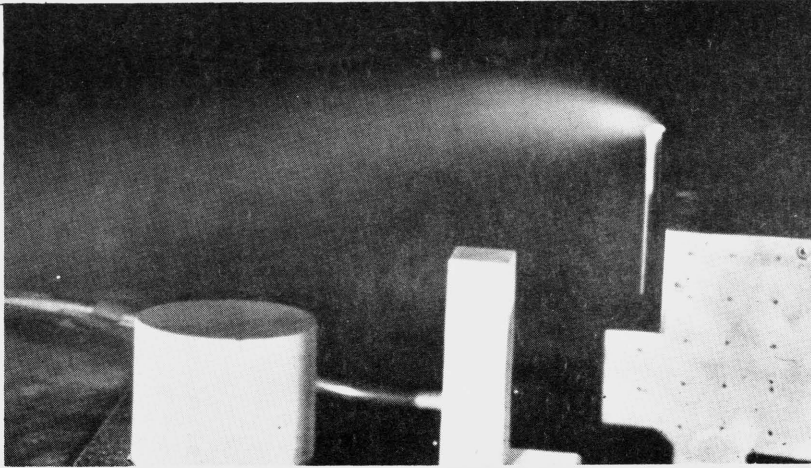

$\theta = 180^\circ$

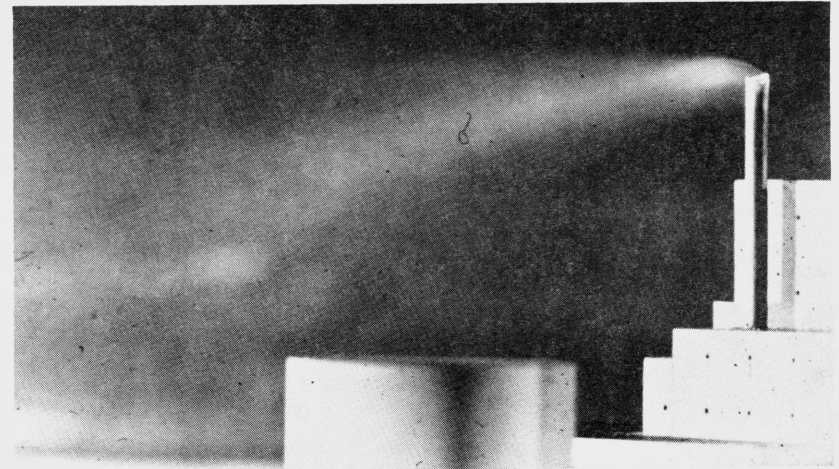

$\theta = 225^\circ$

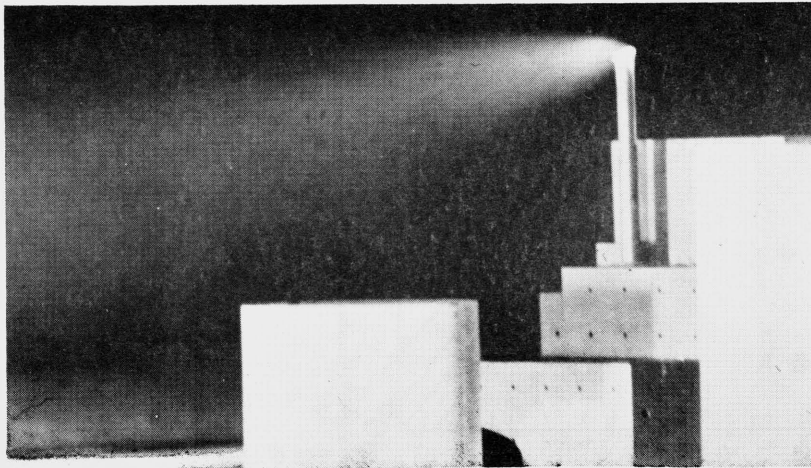

$\theta = 270^\circ$

Figure 24b (continued).

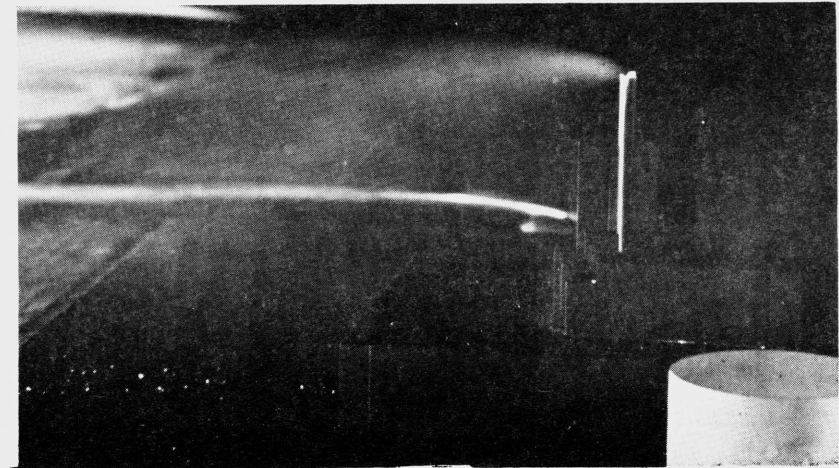

$\theta = 315^\circ$

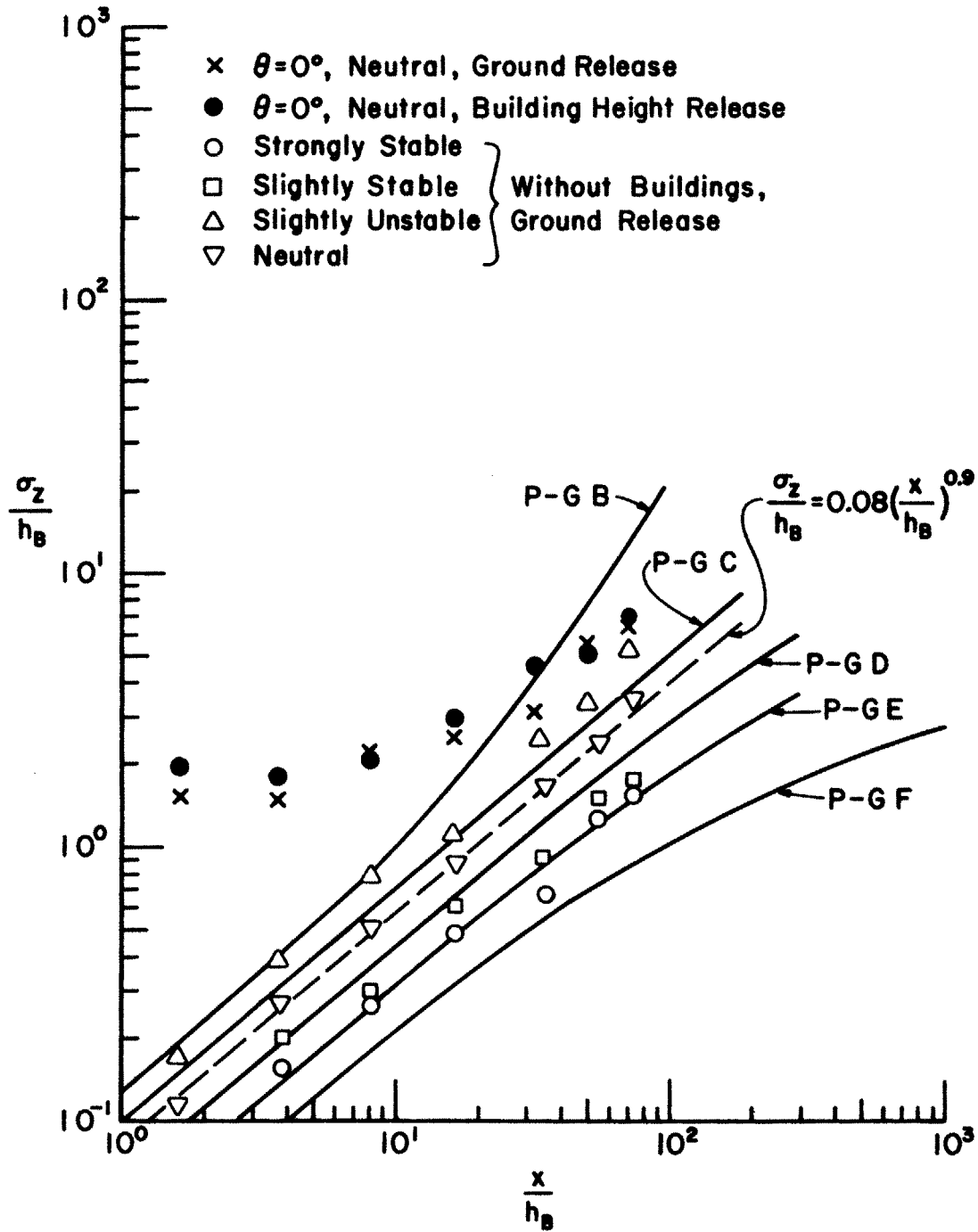

Figure 25. Nondimensional vertical plume spread vs. distance downstream

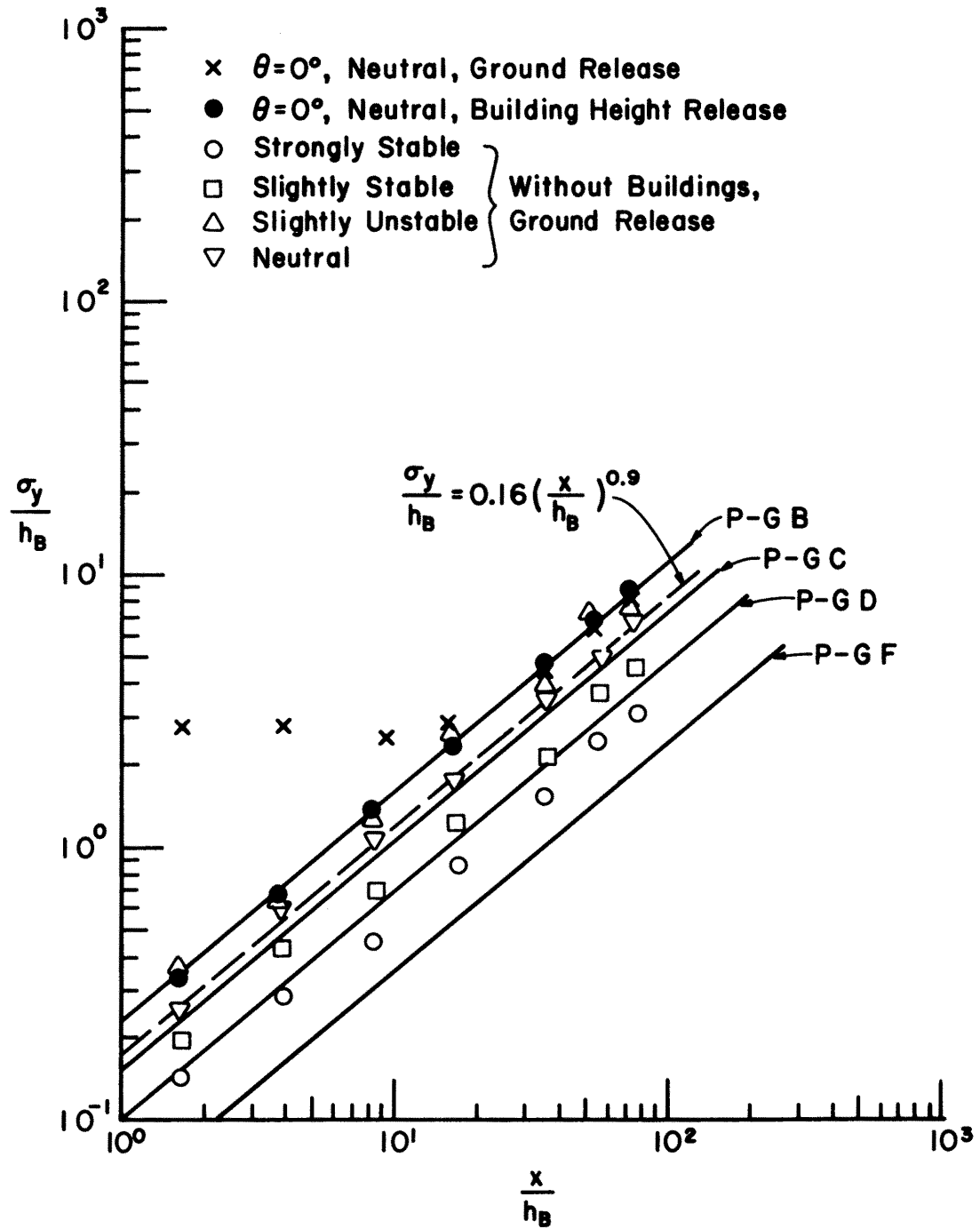

Figure 26. Nondimensional lateral plume spread vs. distance downstream

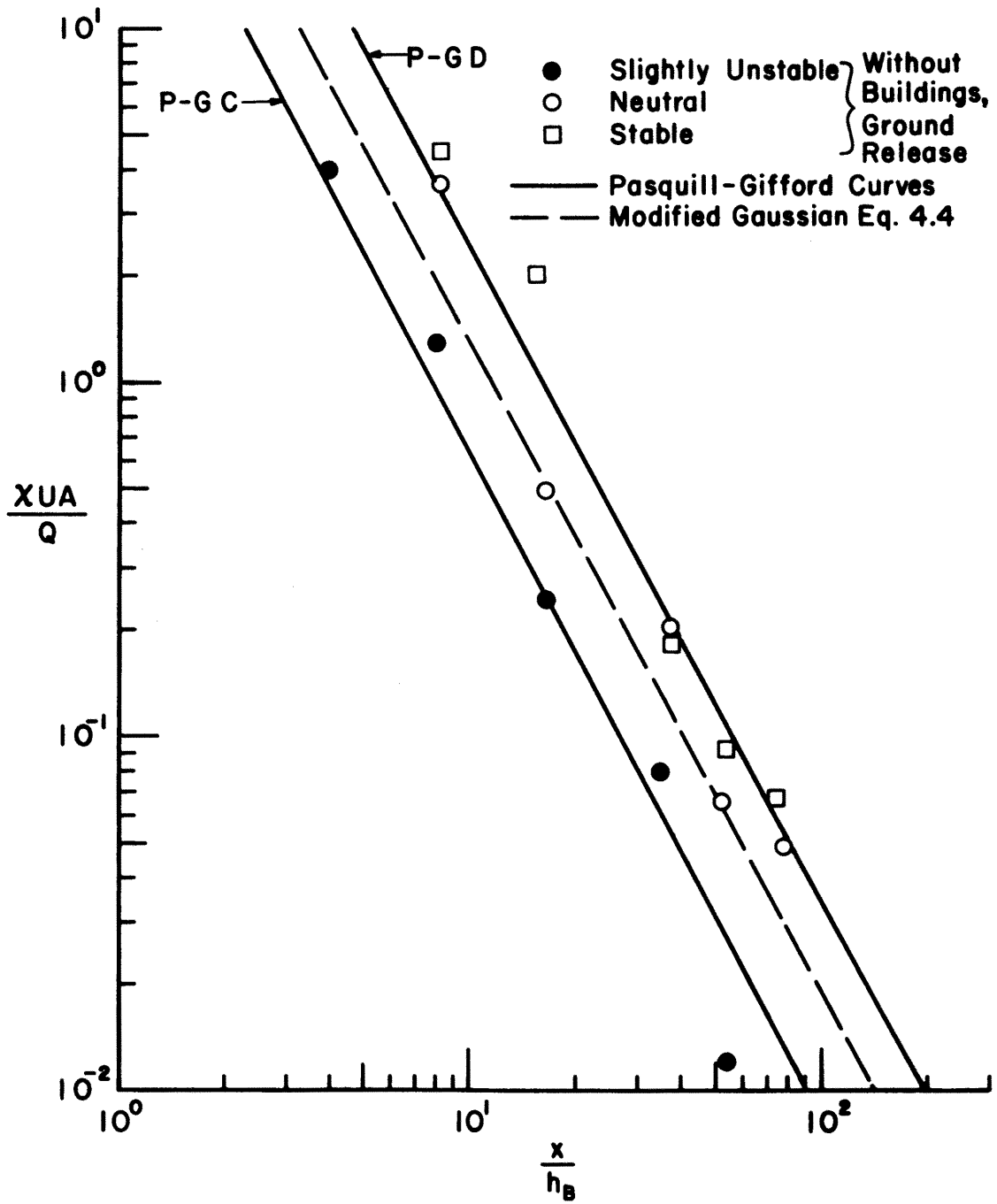

Figure 27. Comparison of models with data, no buildings present

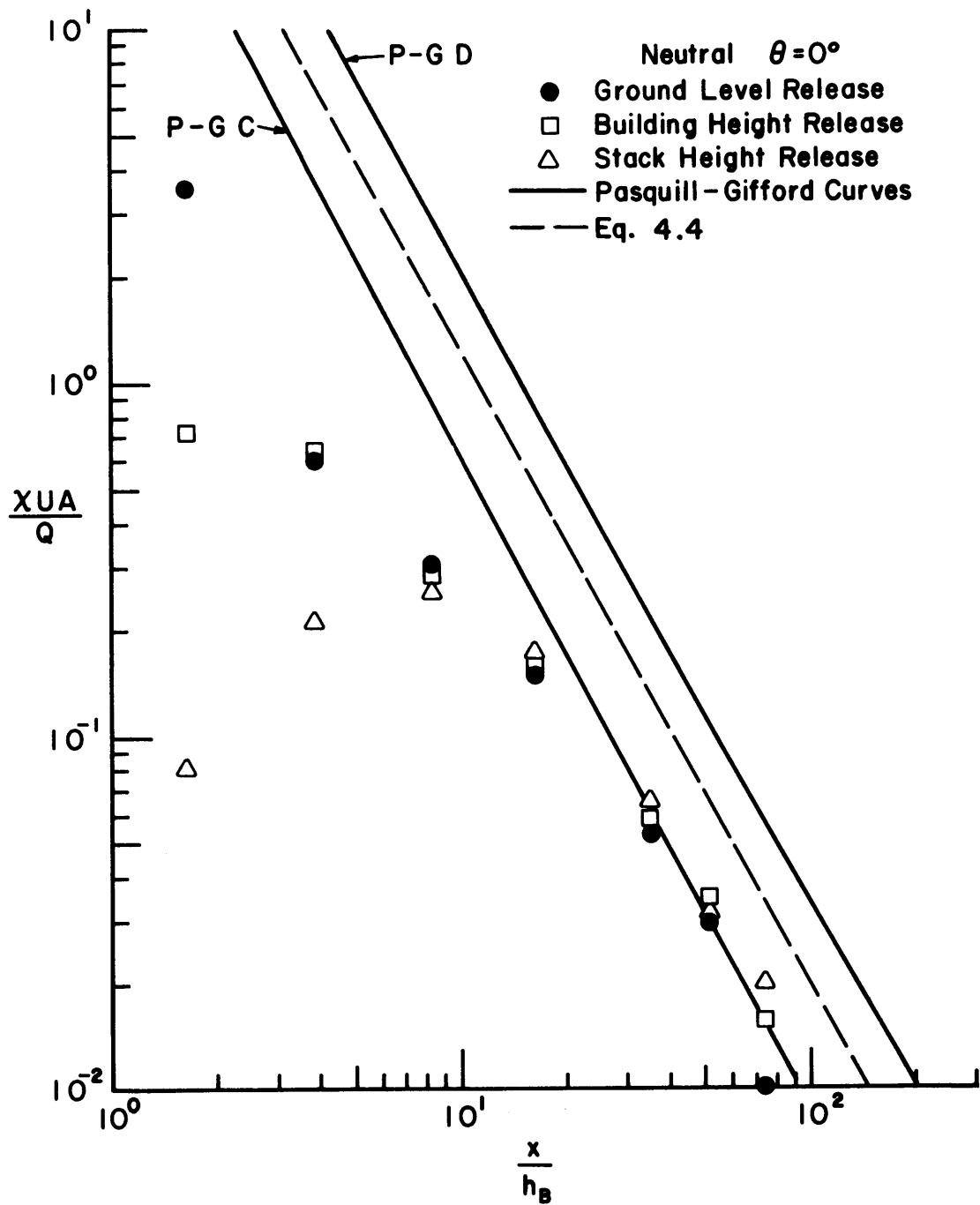

Figure 28a. $\ln \bar{\chi} \bar{U} A / Q$ vs. $\ln x / h_B$ with buildings present
 $\theta = 0^\circ$, neutral

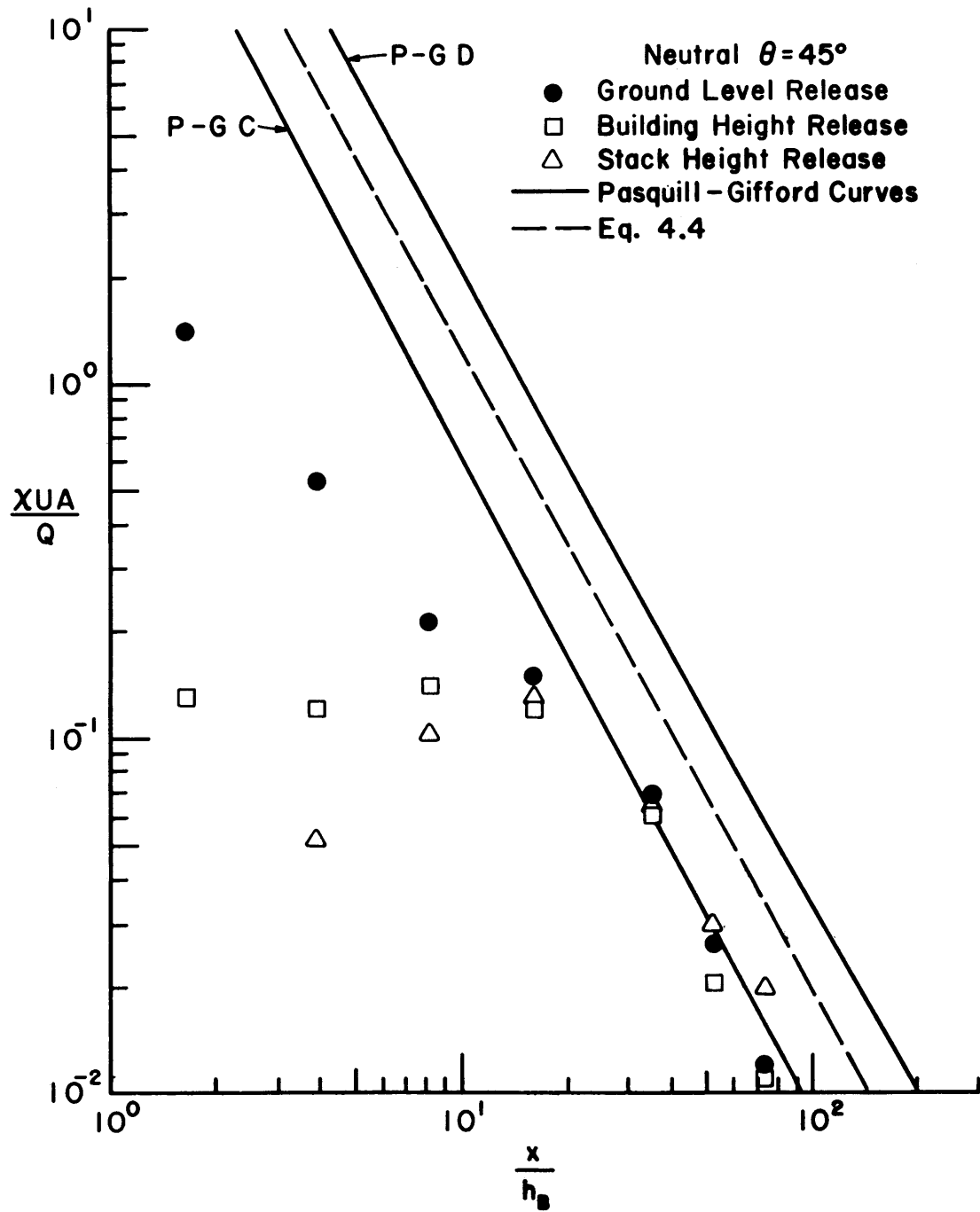

Figure 28b. $\ln \chi UA/Q$ vs. $\ln x/h_B$ with buildings present
 $\theta = 45^\circ$, neutral

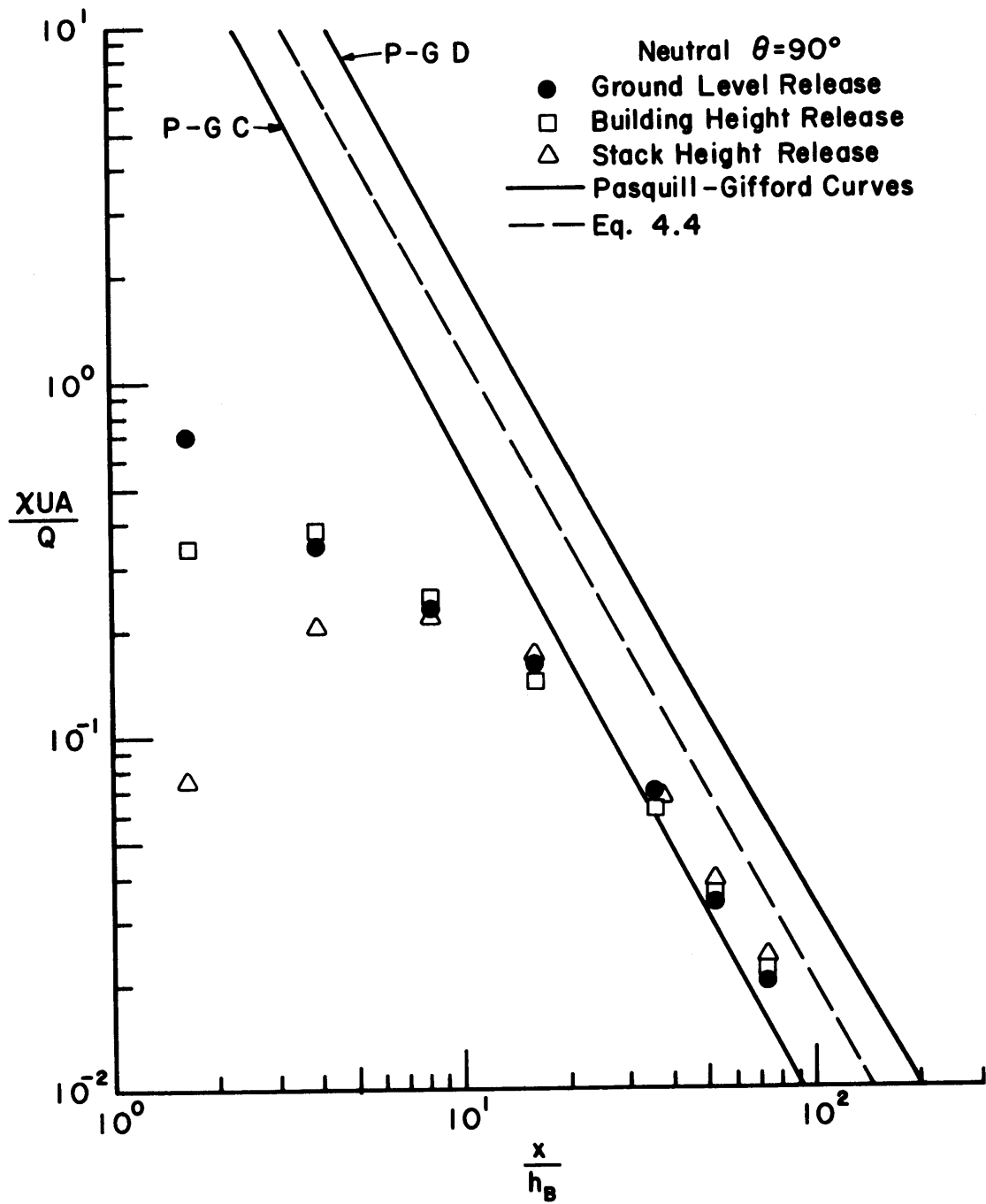

Figure 28c. $\ln \chi \bar{U} A / Q$ vs. $\ln x / h_B$ with buildings present
 $\theta = 90^\circ$, neutral

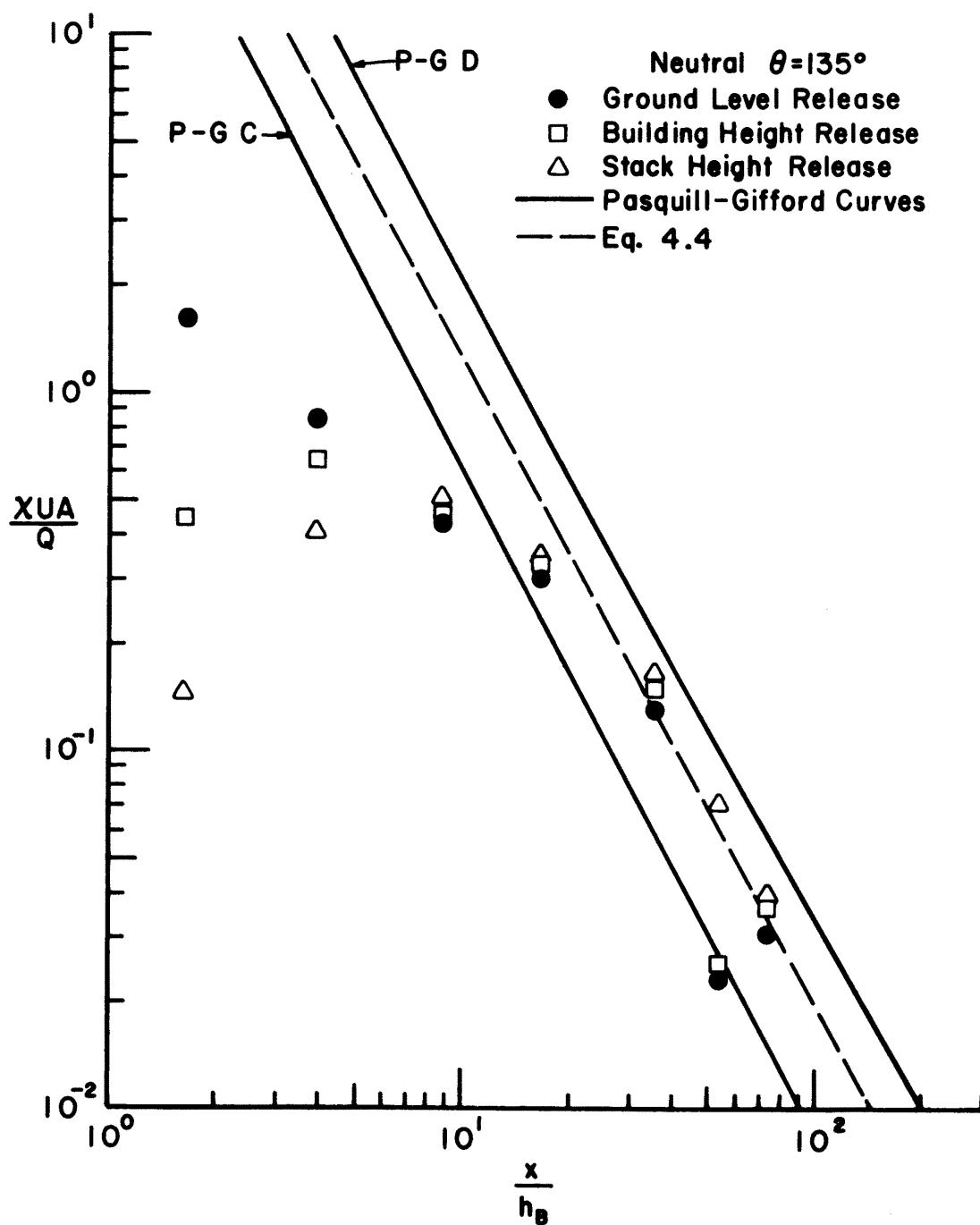

Figure 28d. $\ln \bar{\chi} \bar{U} A / Q$ vs. $\ln x / h_B$ with buildings present
 $\theta = 135^\circ$, neutral

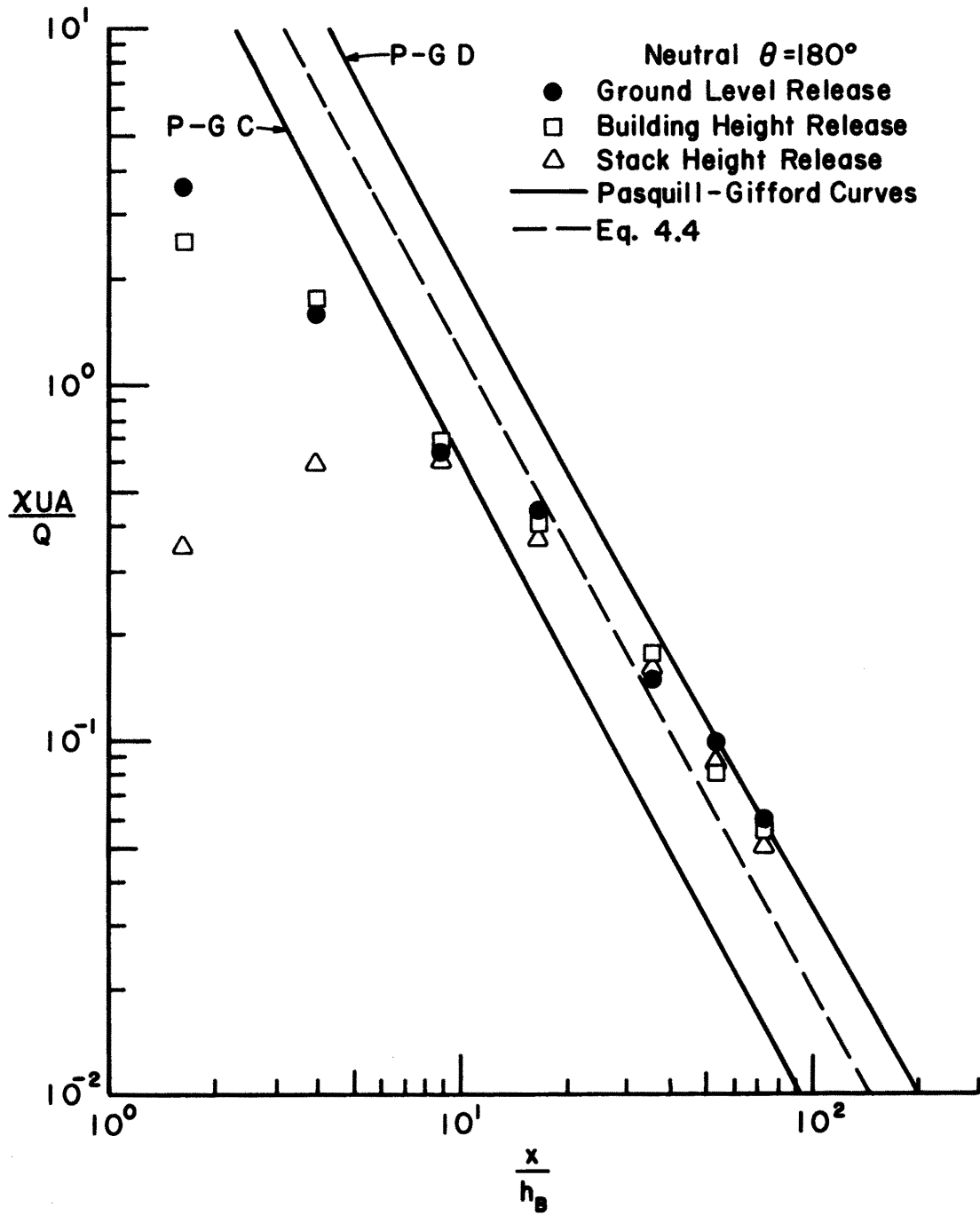

Figure 28e. $\ln \bar{X}UA/Q$ vs. $\ln x/h_B$ with buildings present
 $\theta = 180^\circ$, neutral

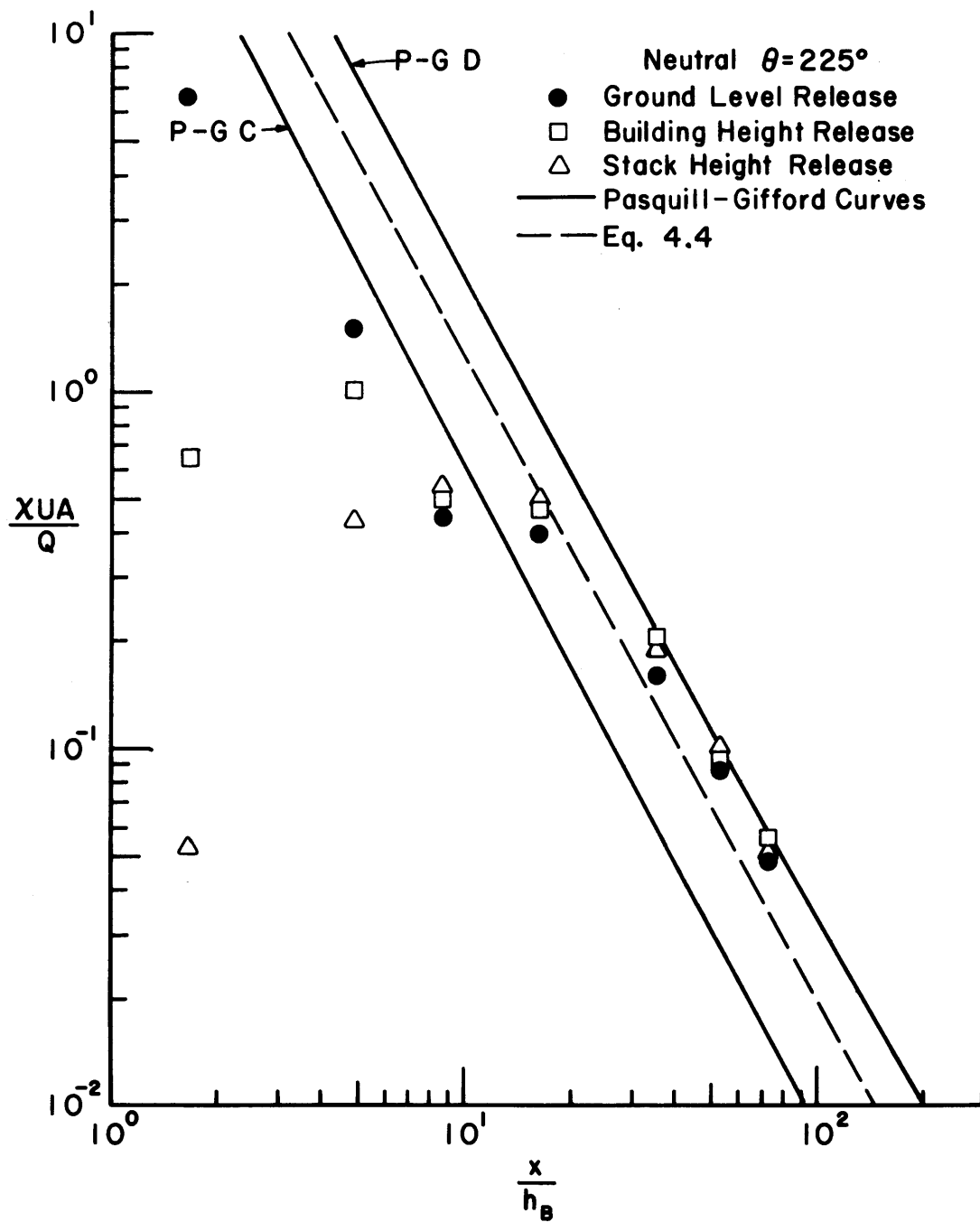

Figure 28f. $\ln \bar{\chi} \bar{U} A / Q$ vs. $\ln x / h_B$ with buildings present $\theta = 225^\circ$, neutral

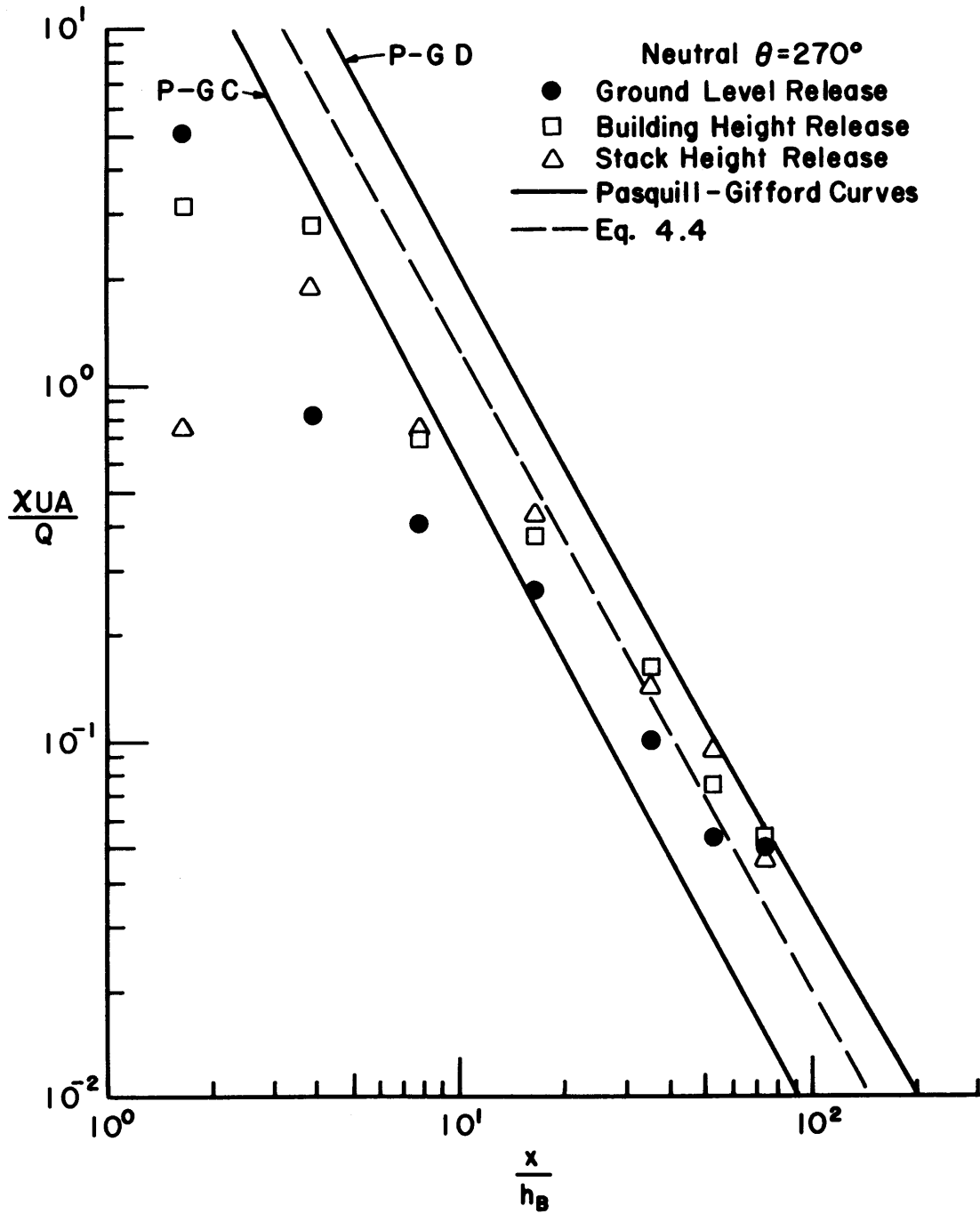

Figure 28g. $\ln \bar{\chi}UA/Q$ vs. $\ln x/h_B$ with buildings present
 $\theta = 270^\circ$, neutral

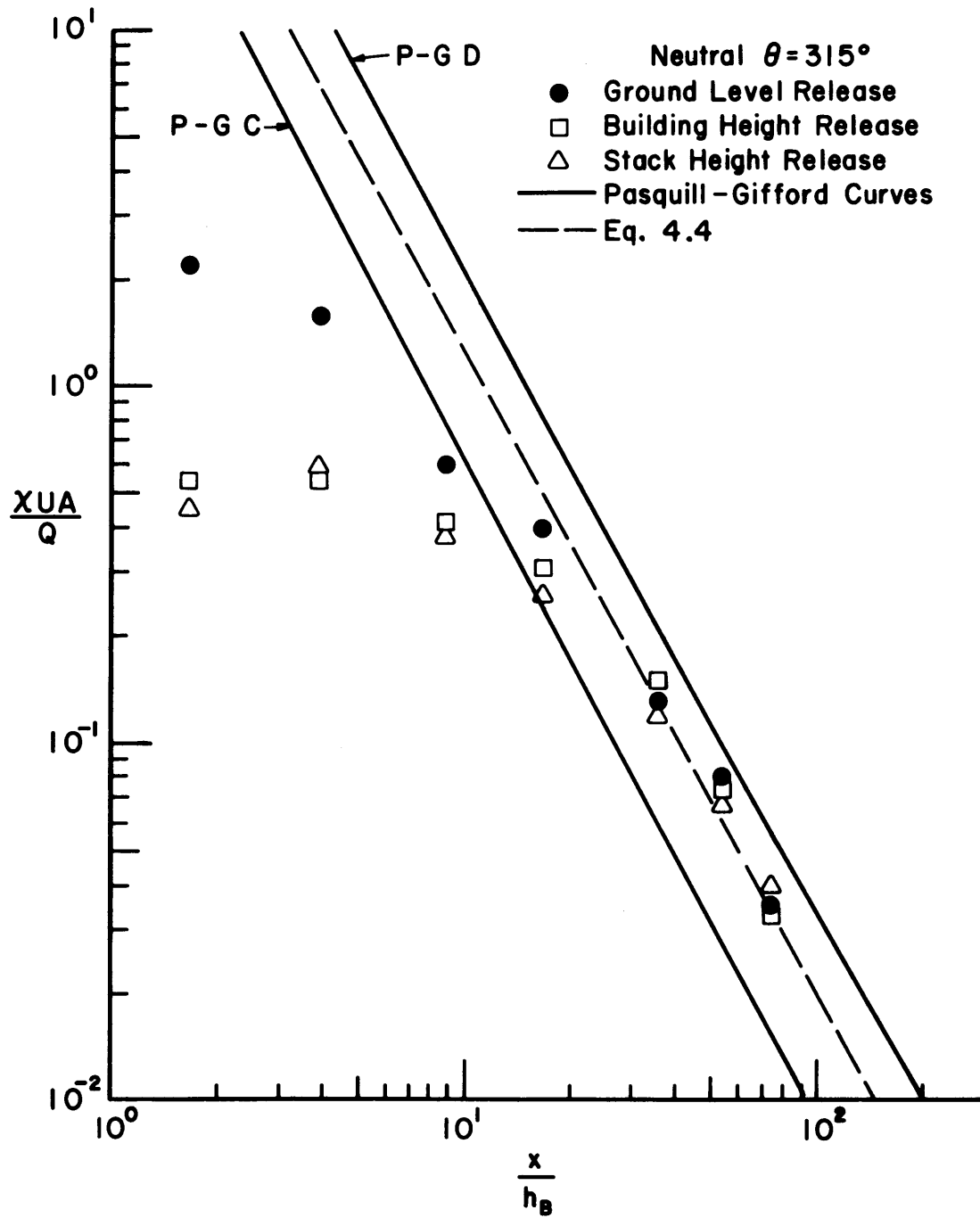

Figure 28h. $\ln \bar{\chi}UA/Q$ vs. $\ln x/h_B$ with buildings present
 $\theta = 315^\circ$, neutral

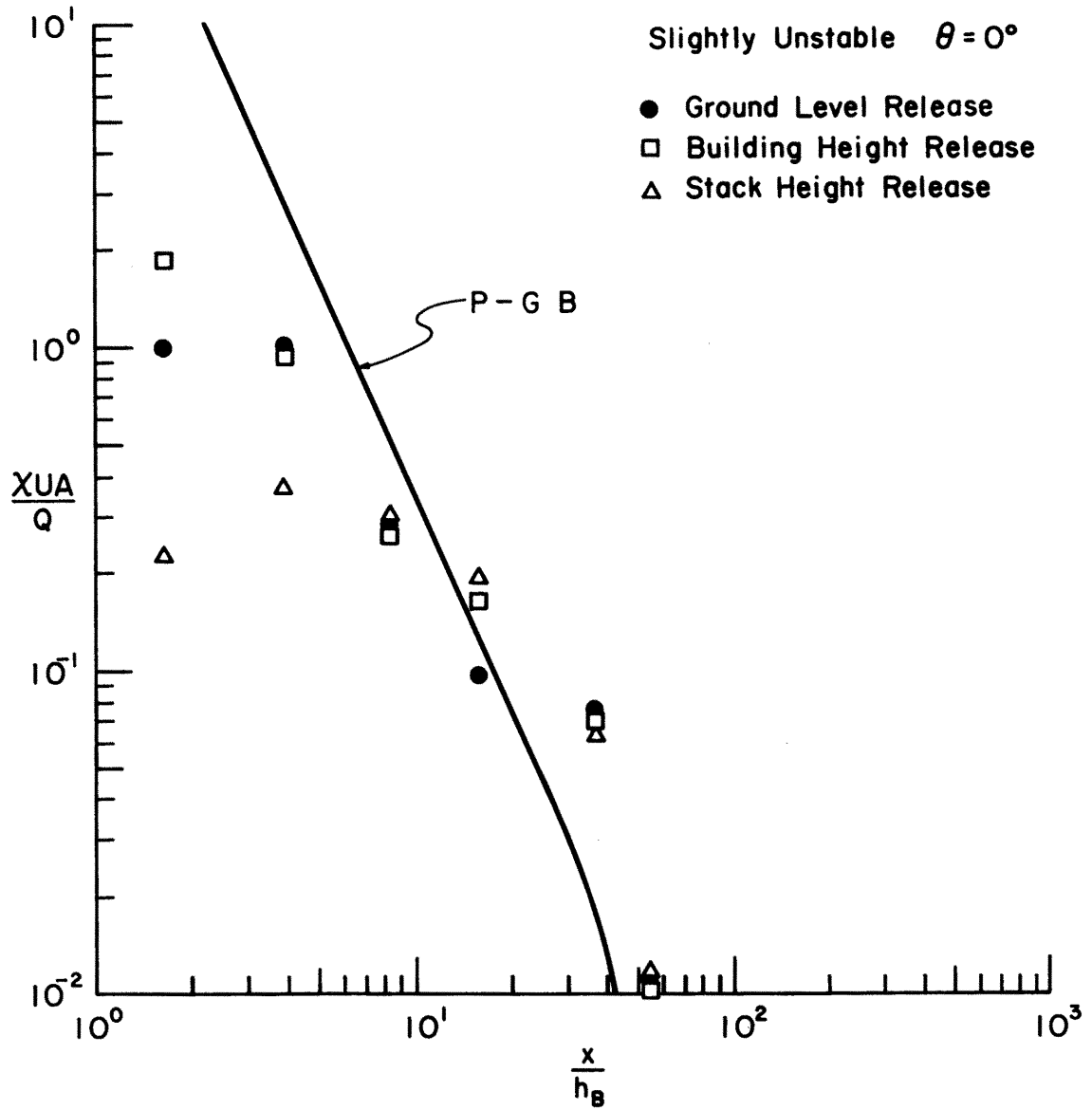

Figure 29a. $\ln \frac{\chi \bar{U} A}{Q}$ vs. $\ln \frac{x}{h_B}$ with buildings present
 $\theta = 0^\circ$, slightly unstable

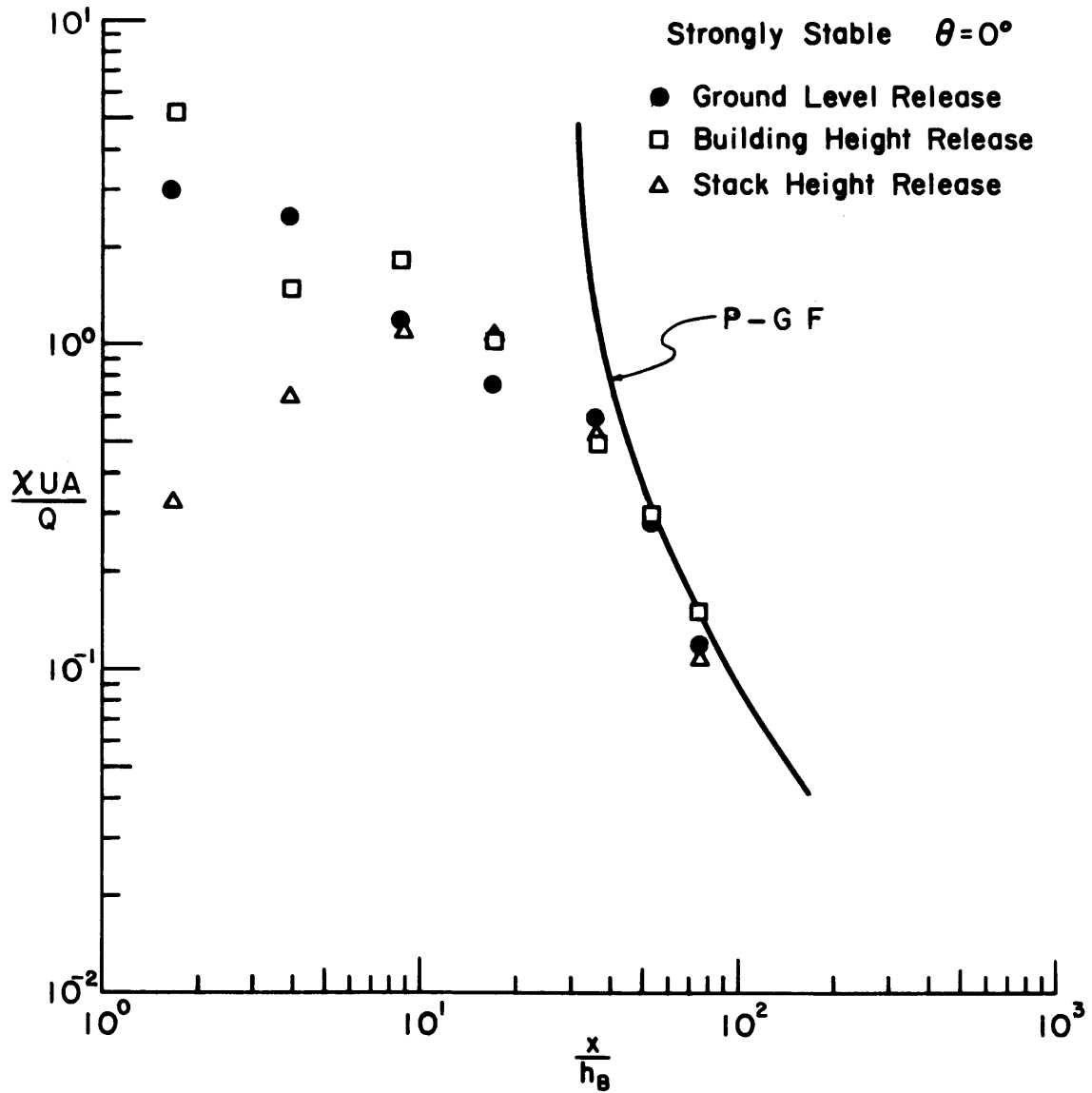

Figure 29b. $\ln \chi \bar{U} A / Q$ vs. $\ln x / h_B$ with buildings present
 $\theta = 0^\circ$, strongly stable

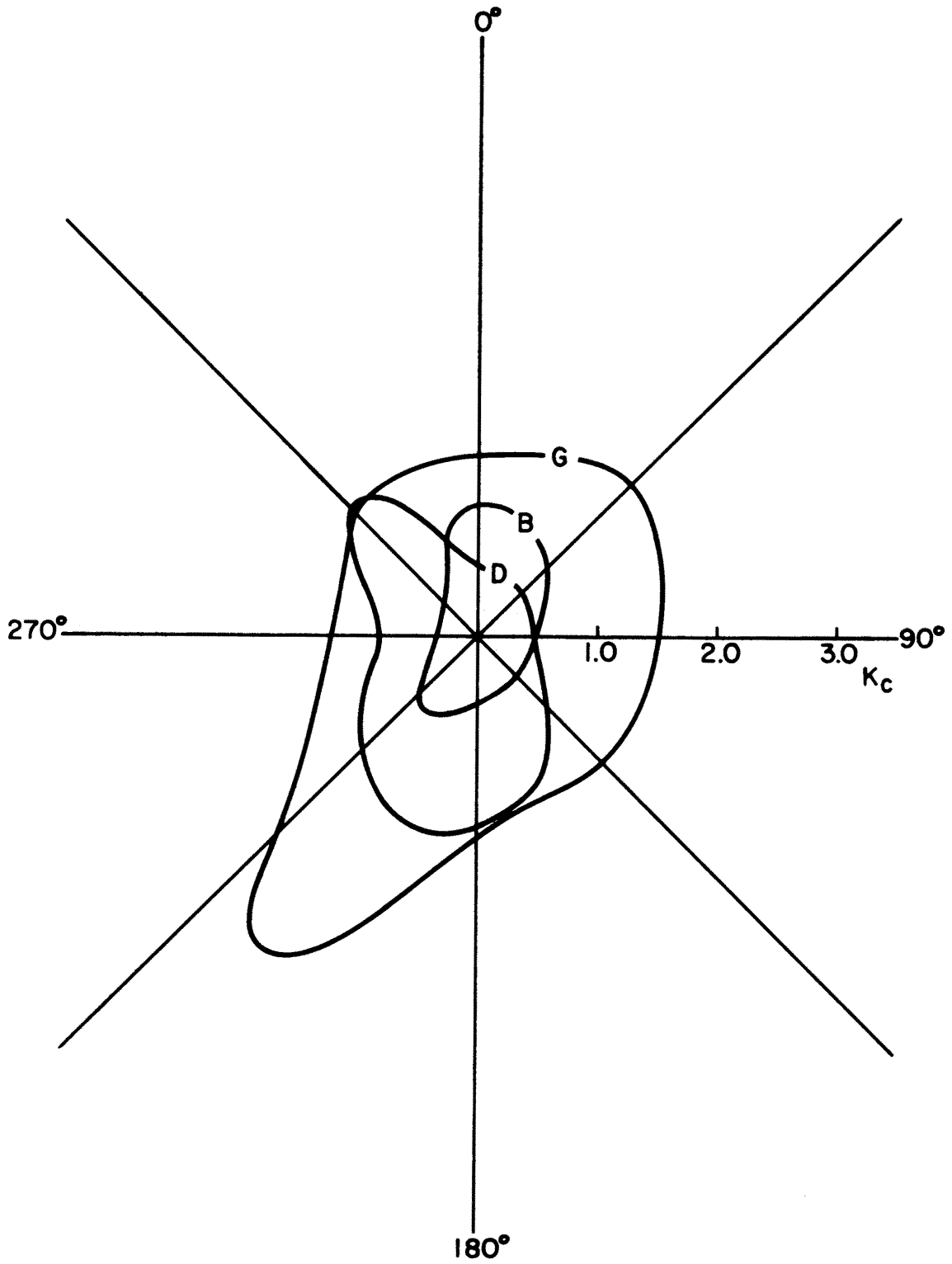

Figure 30. Polar diagram of K_{\max} as measured at 87 m versus wind approach angle for ground level release.

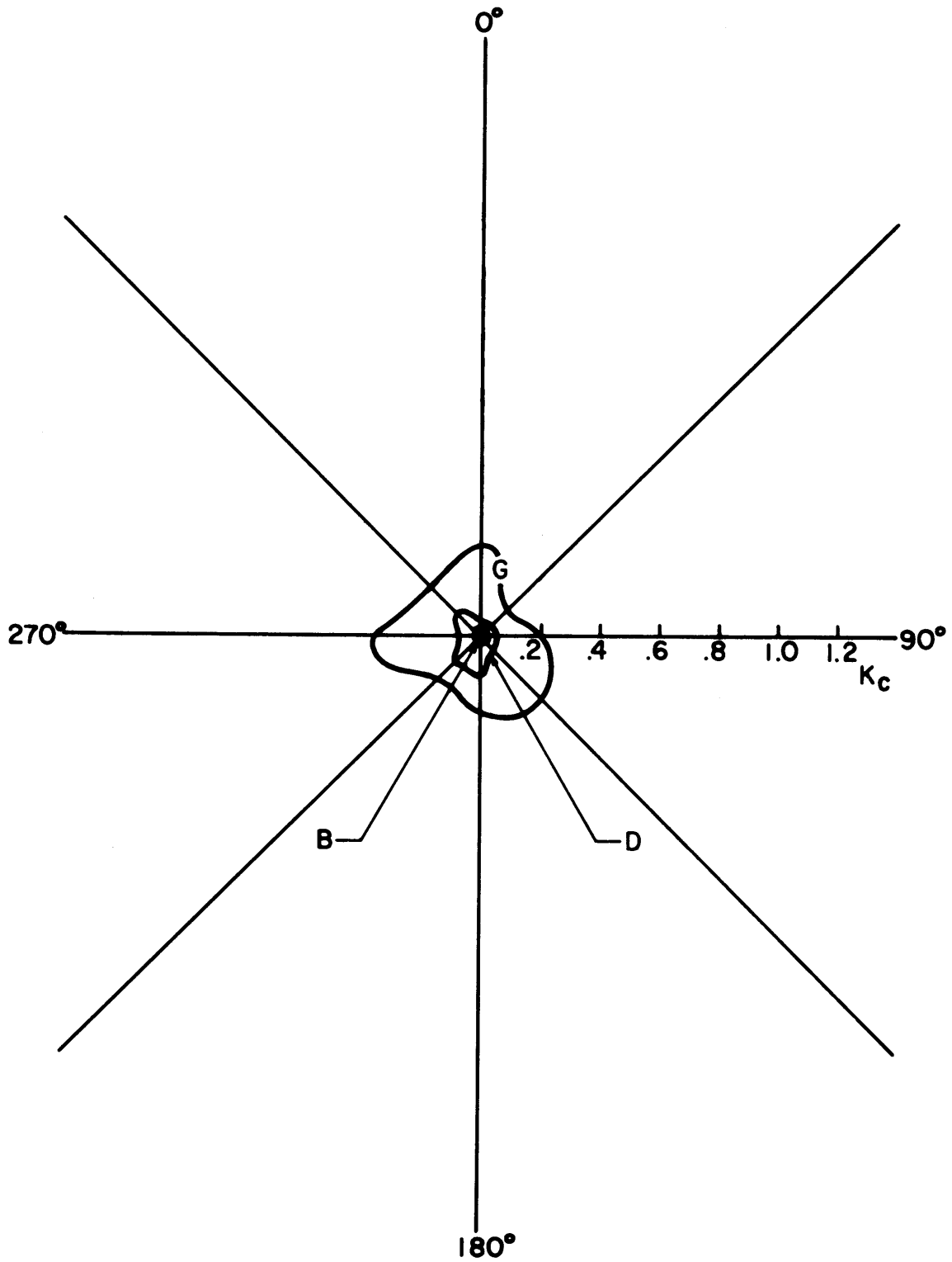

Figure 31. Polar diagram of K_{max} as measured at 1200 m versus wind approach angle for ground level release.

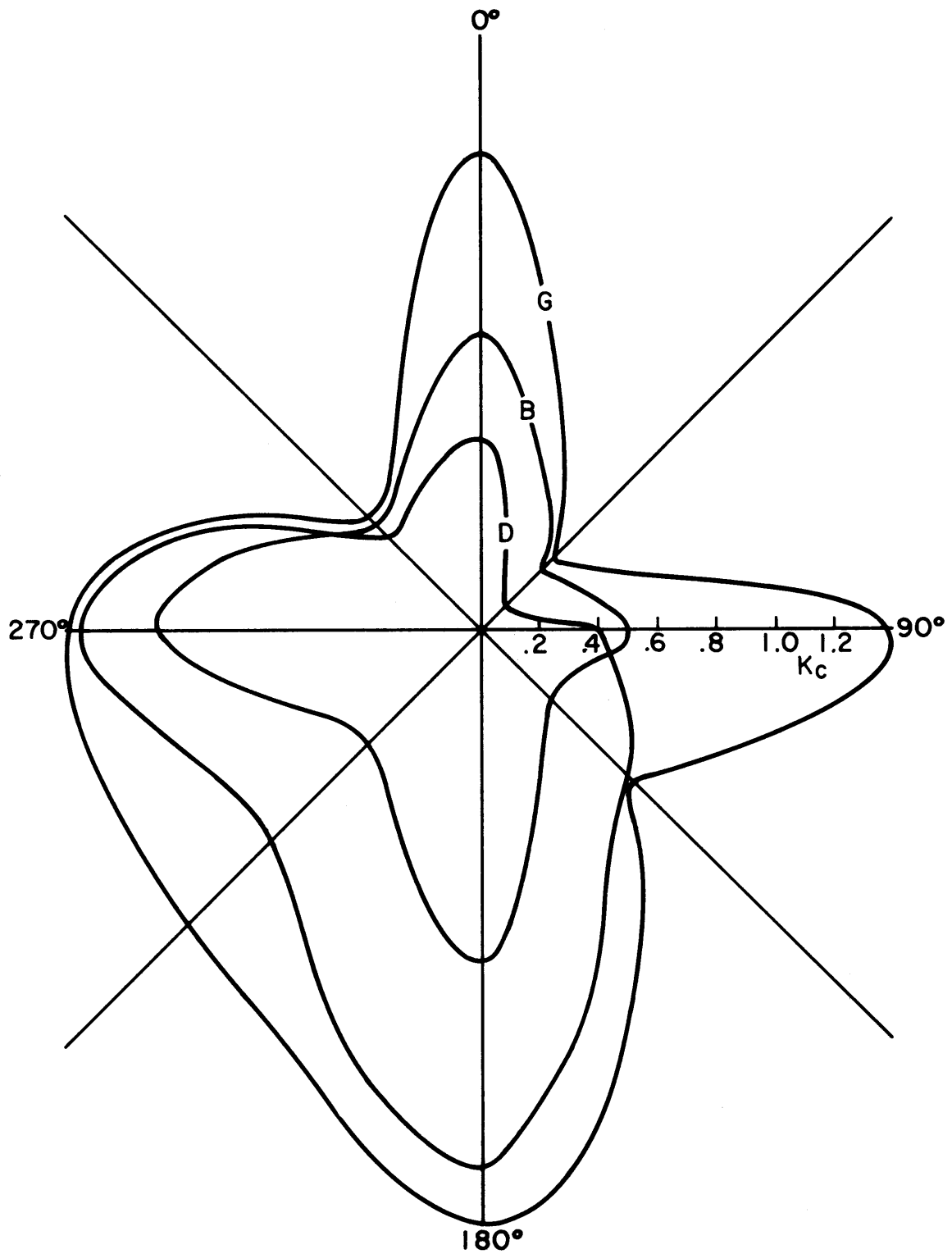

Figure 32. Polar diagram of K_{max} as measured at 87 m versus wind approach angle for building height release.

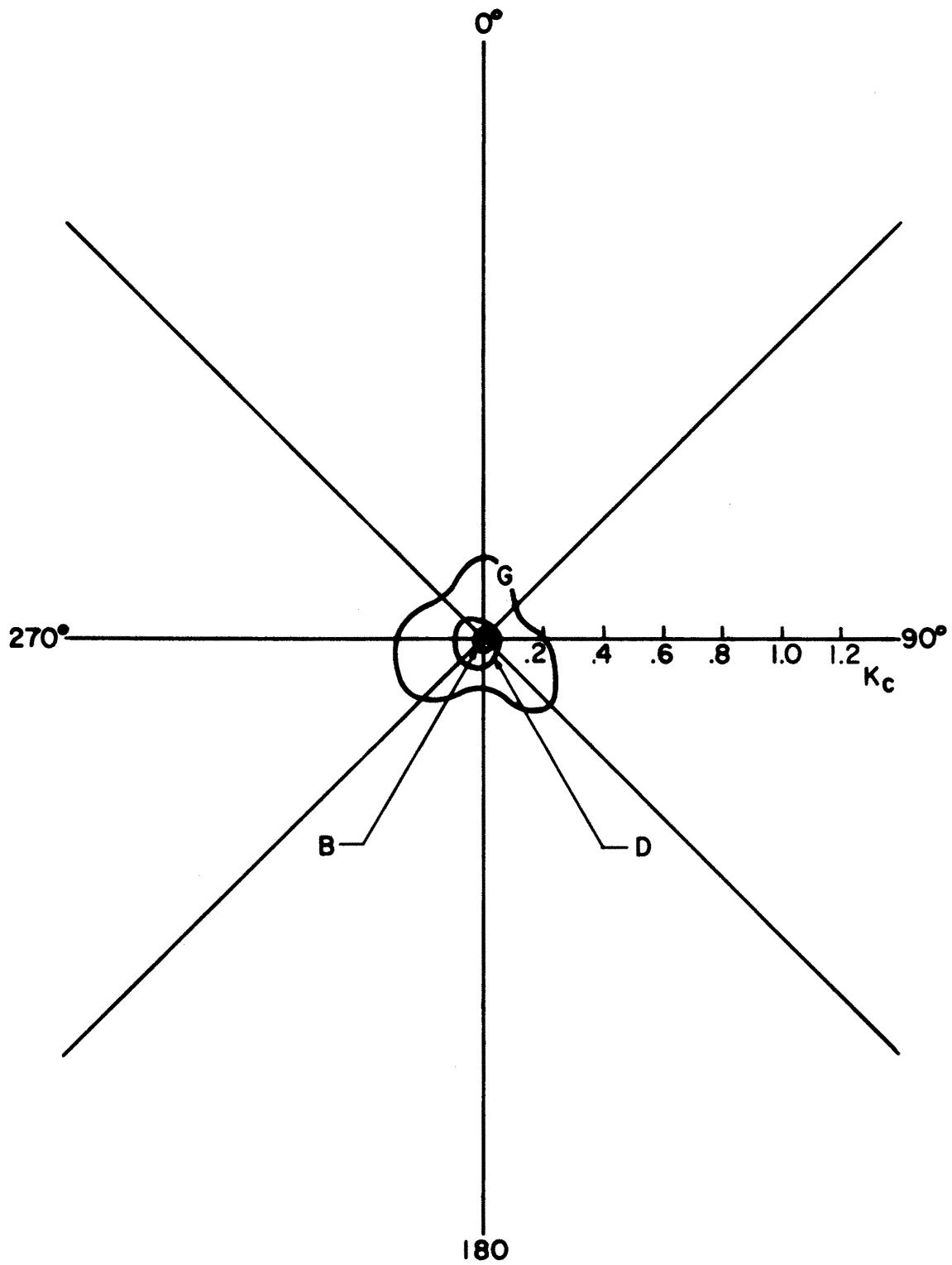

Figure 33. Polar diagram of K_{max} as measured at 1200 m versus wind approach angle for building height release.

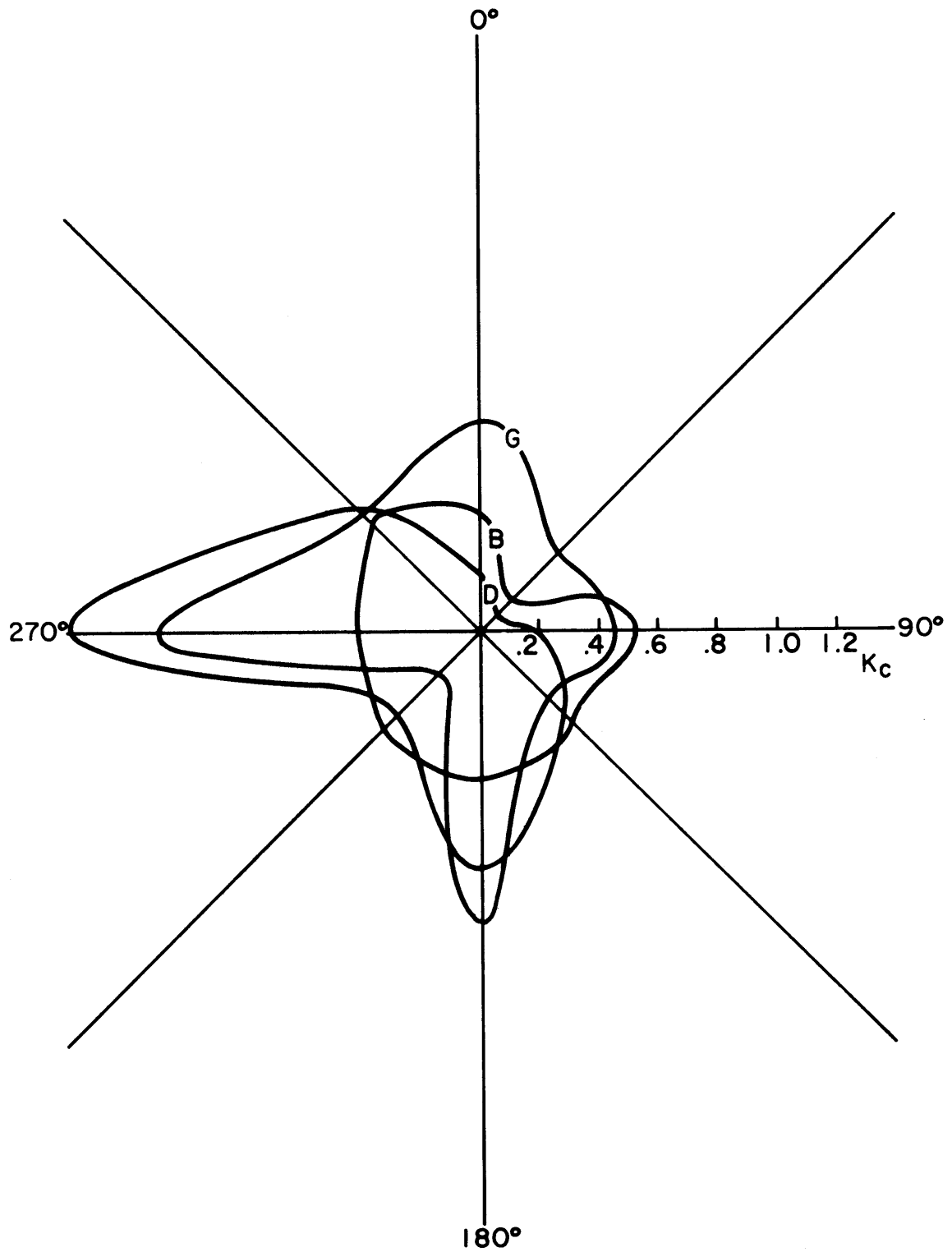

Figure 34. Polar diagram of K_{max} as measured at 87 m versus wind approach angle for stack height release.

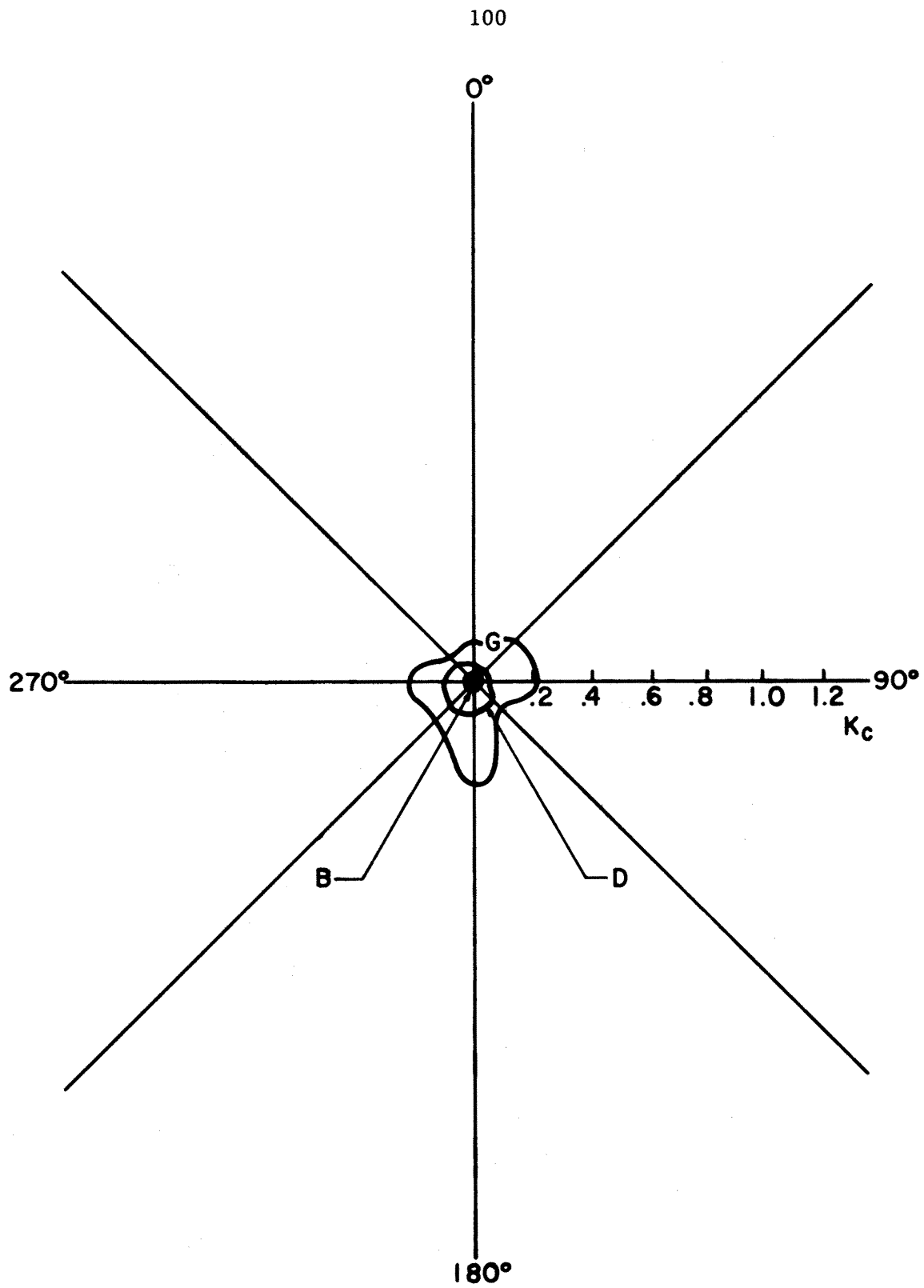

Figure 35. Polar diagram of K_{max} as measured at 1200 m versus wind approach angle for stack height release.

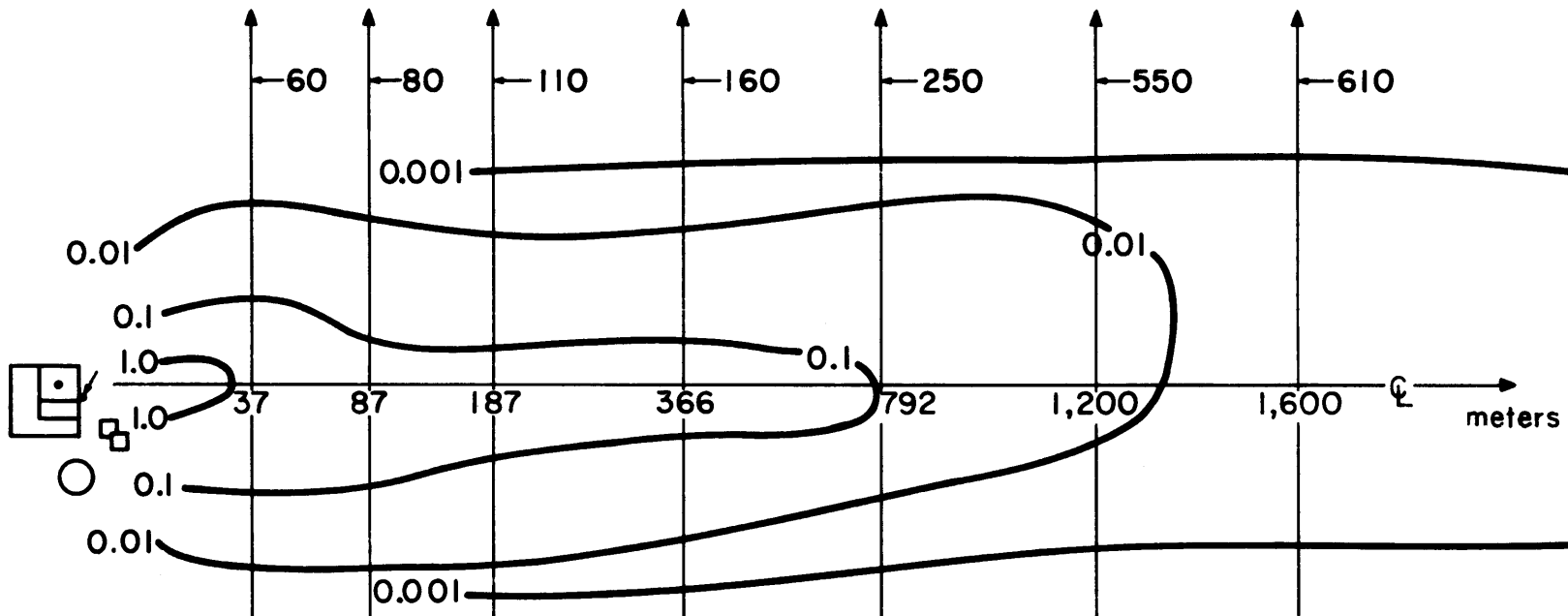

Figure 36. Diffusion isopleths, $\theta = 135^\circ$
slightly unstable, ground release

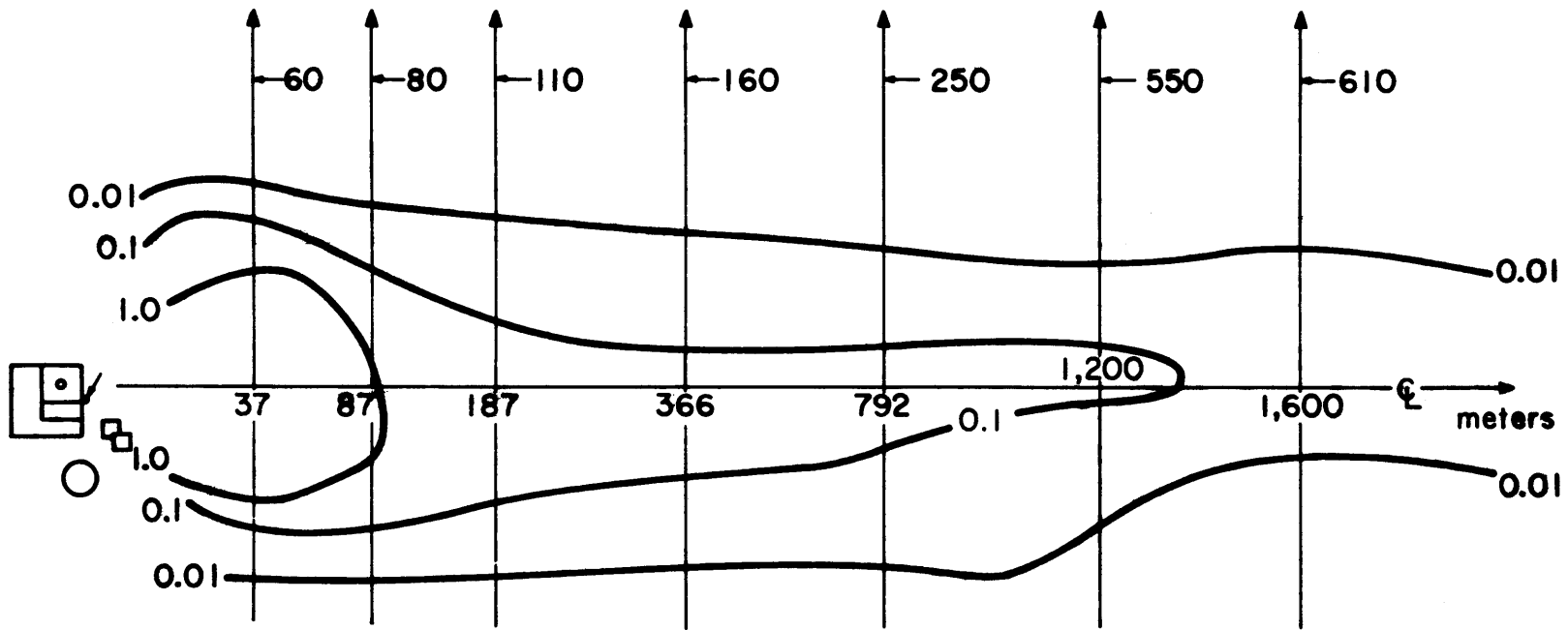

Figure 37. Diffusion isopleths, ground level x-y plane
neutral, ground release, $\theta = 135^\circ$

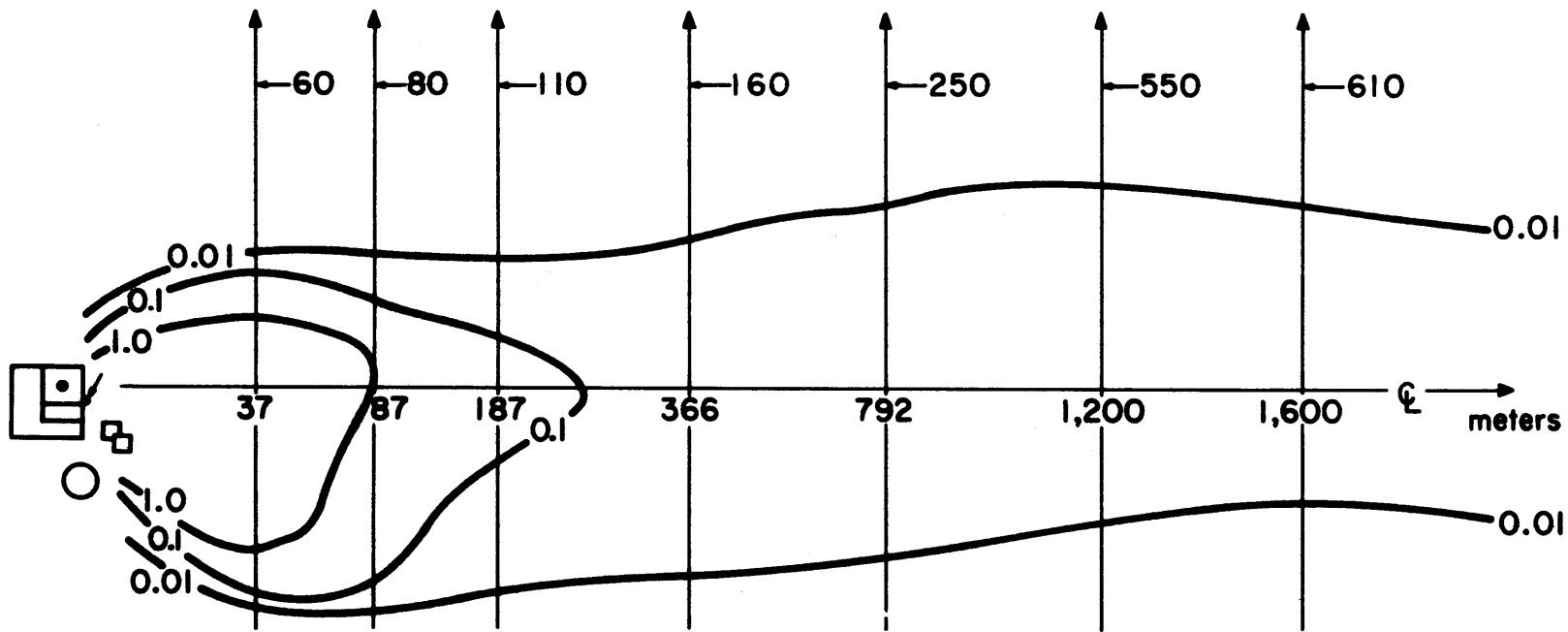

Figure 38. Diffusion isopleths, $\theta = 135^\circ$
slightly stable, ground release

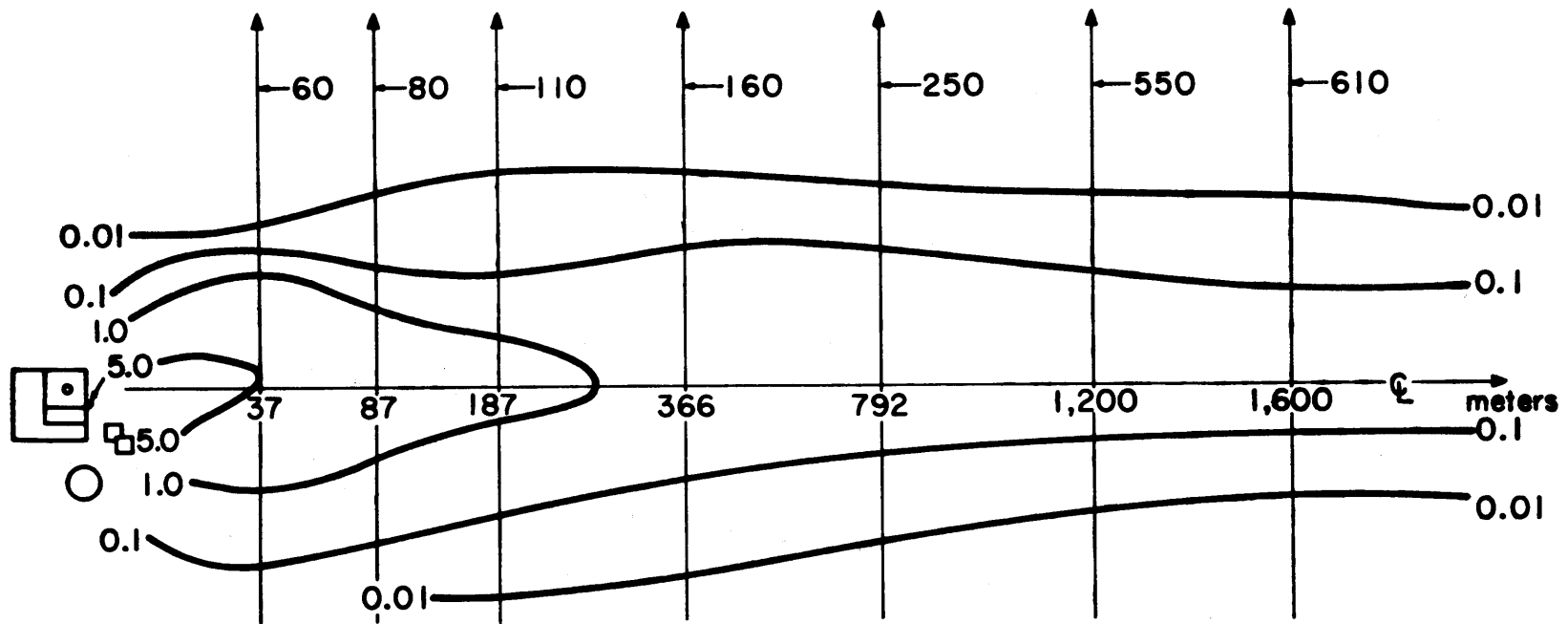

Figure 39. Diffusion isopleths, $\theta = 135^\circ$,
strongly stable, ground release

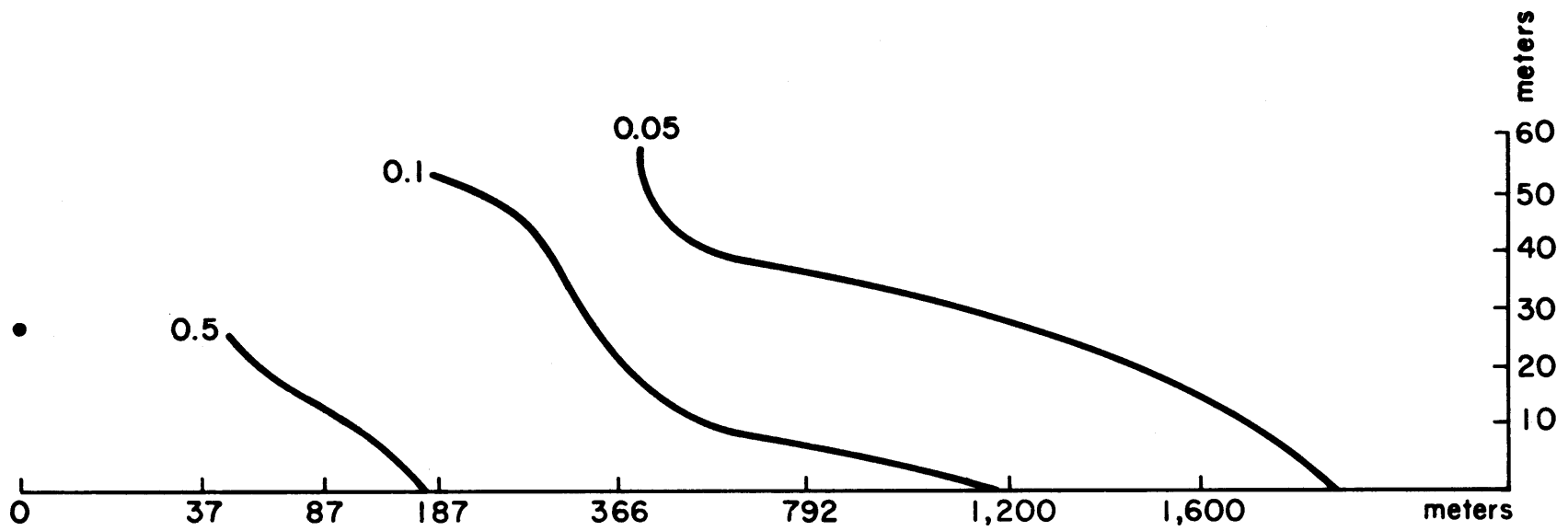

Figure 40. Diffusion isopleths, $\theta = 315^\circ$, neutral, stack release

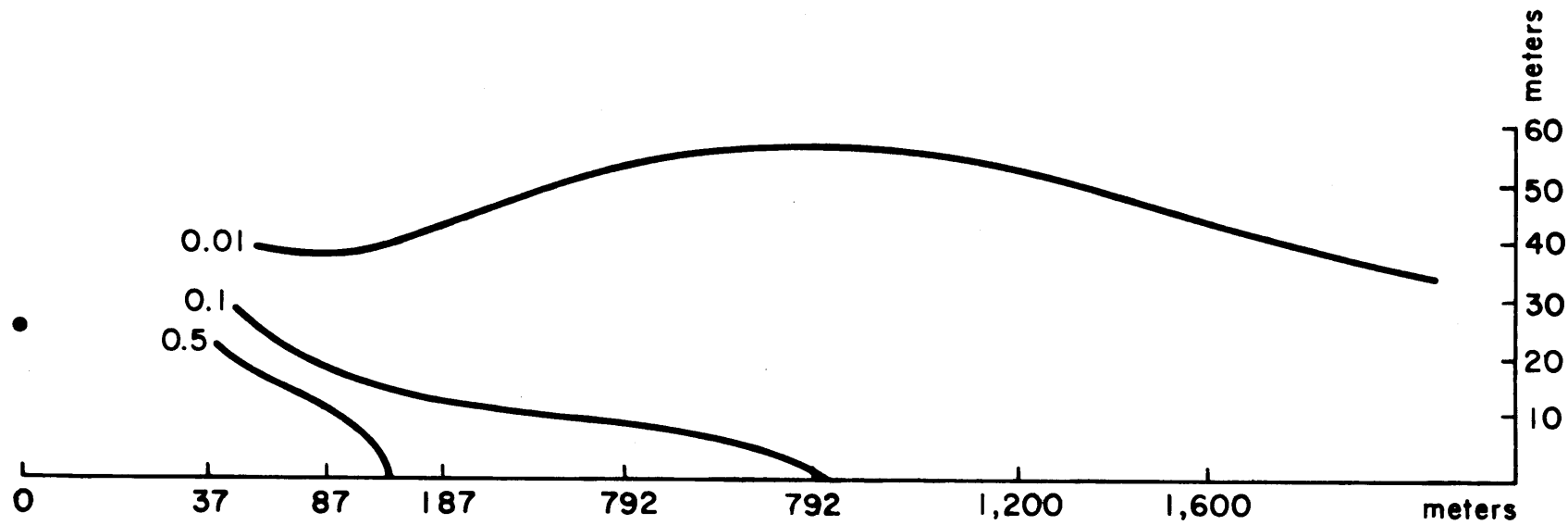

Figure 41. Diffusion isopleths, vertical x-z plane
neutral, stack release, $\theta = 315^\circ$

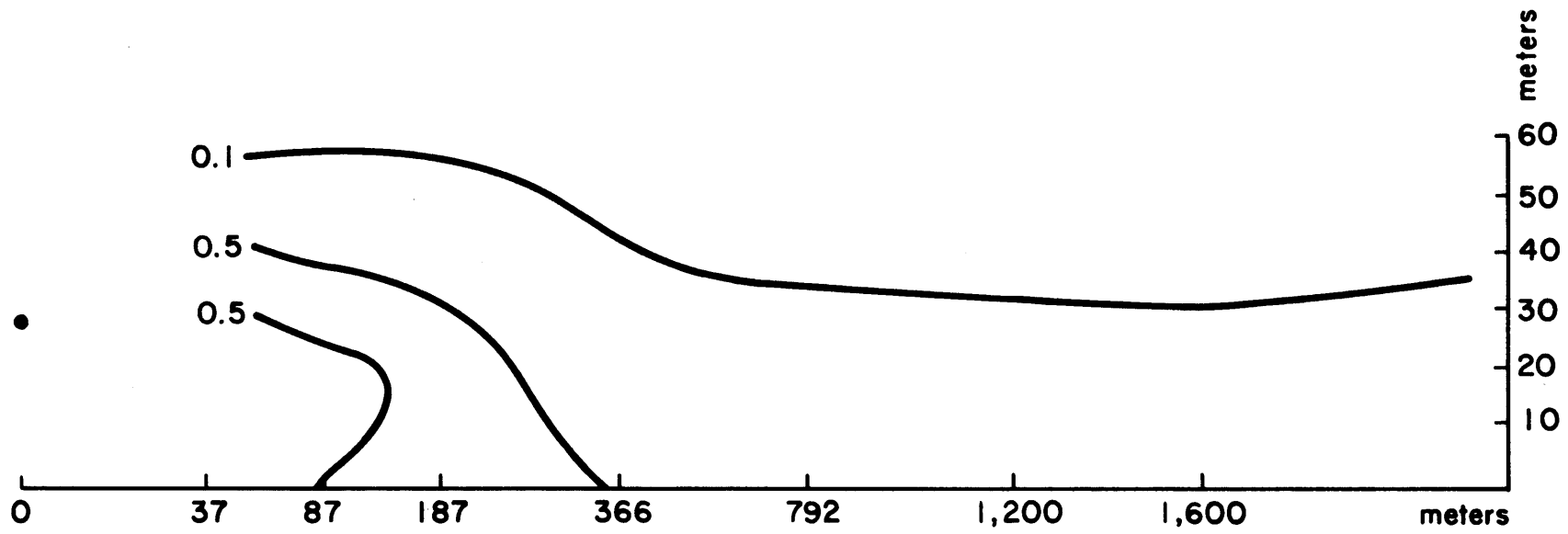

Figure 42. Diffusion isopleths, vertical x-z plane
 strongly stable, stack release, $\theta = 315^\circ$

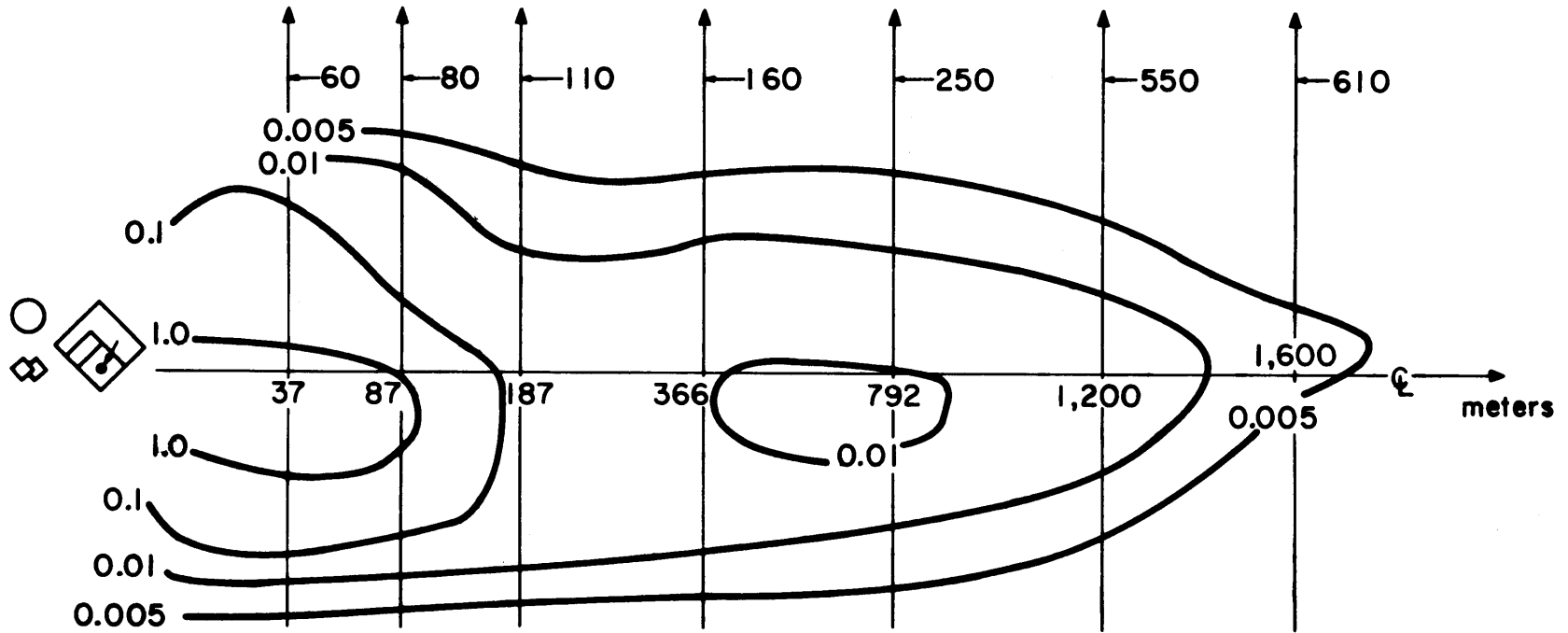

Figure 43. Diffusion isopleths, $\theta = 0^\circ$
slightly unstable, building height release

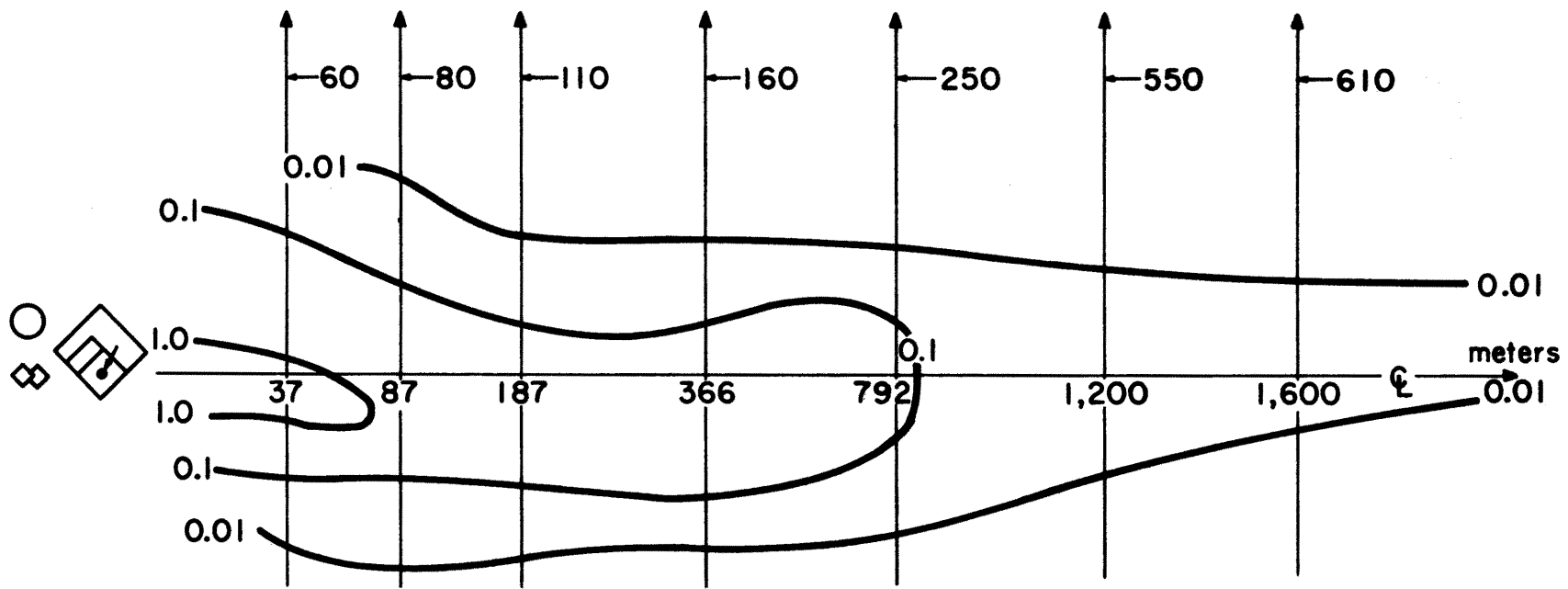

Figure 44. Diffusion isopleths, $\theta = 0^\circ$
neutral, building height release

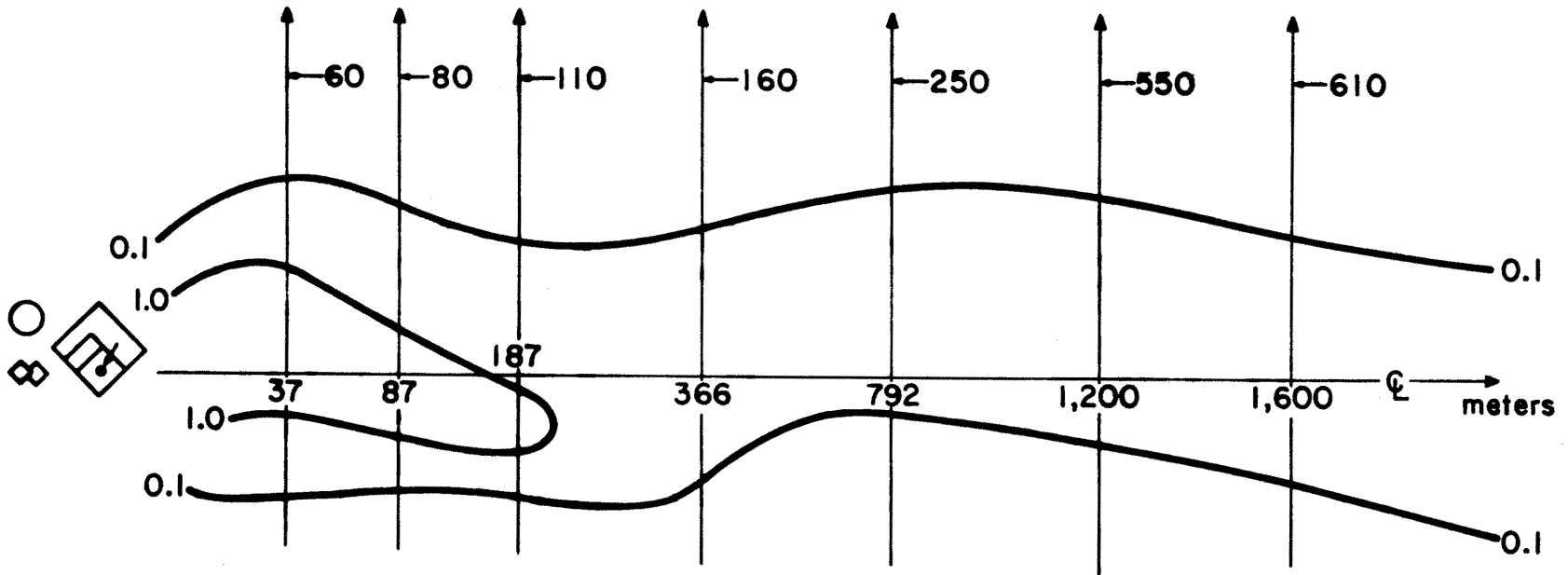

Figure 45. Diffusion isopleths, $\theta = 0^\circ$
slightly stable, building height release

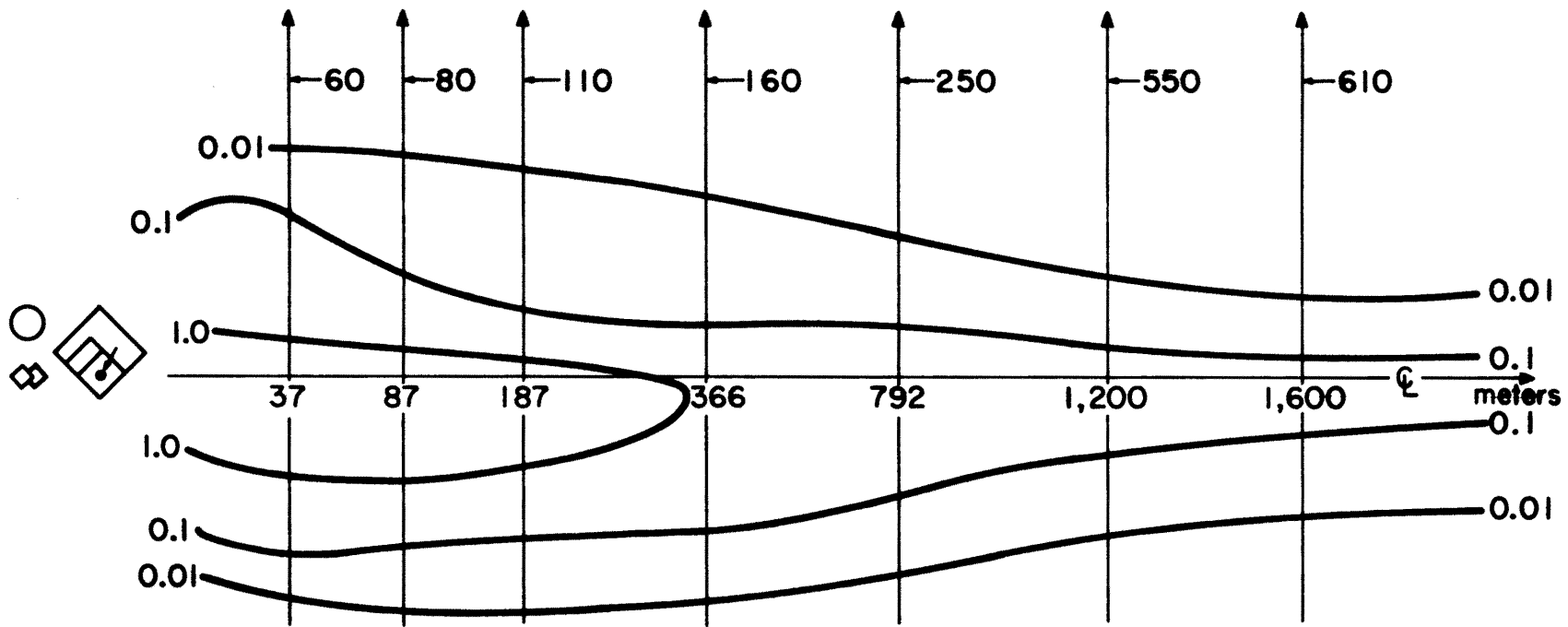

Figure 46. Diffusion isopleths, $\theta = 0^\circ$
strongly stable, building height release

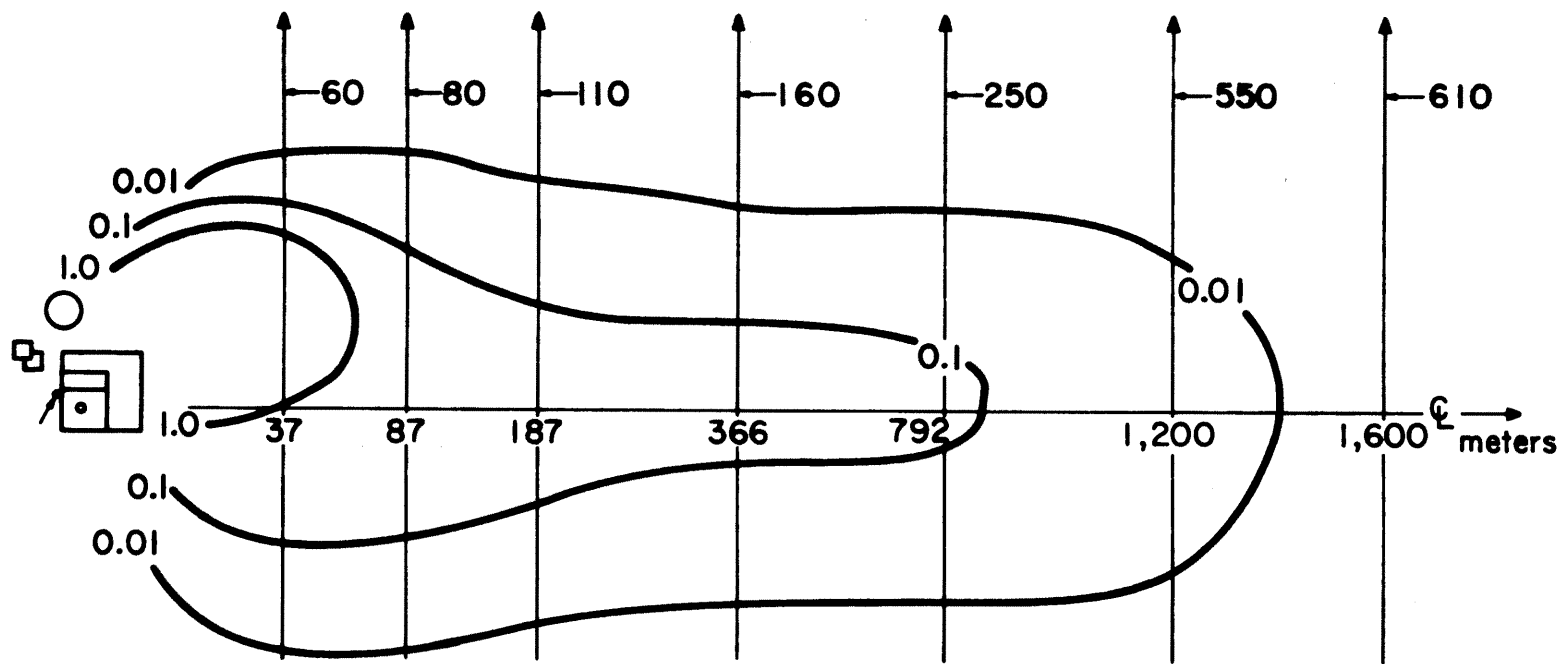

Figure 47. Diffusion isopleths, $\theta = 315^\circ$
slightly unstable, ground release

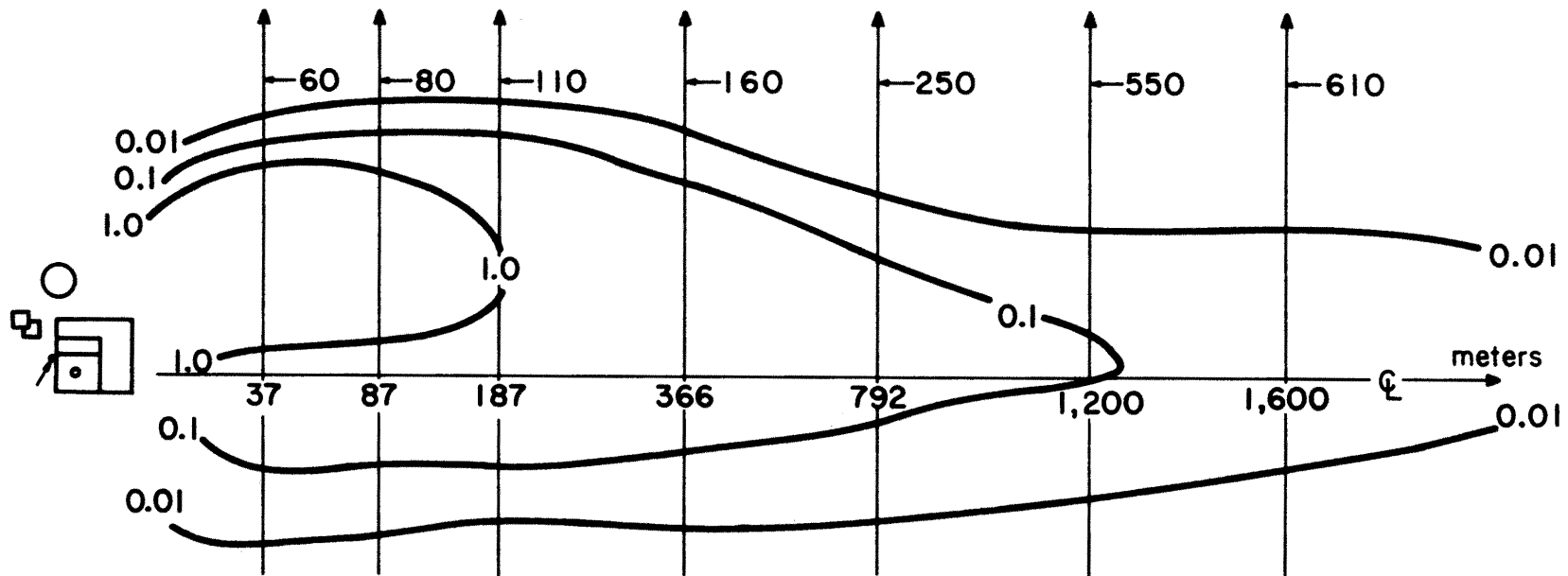

Figure 48. Diffusion isopleths, $\theta = 315^\circ$
neutral, ground release

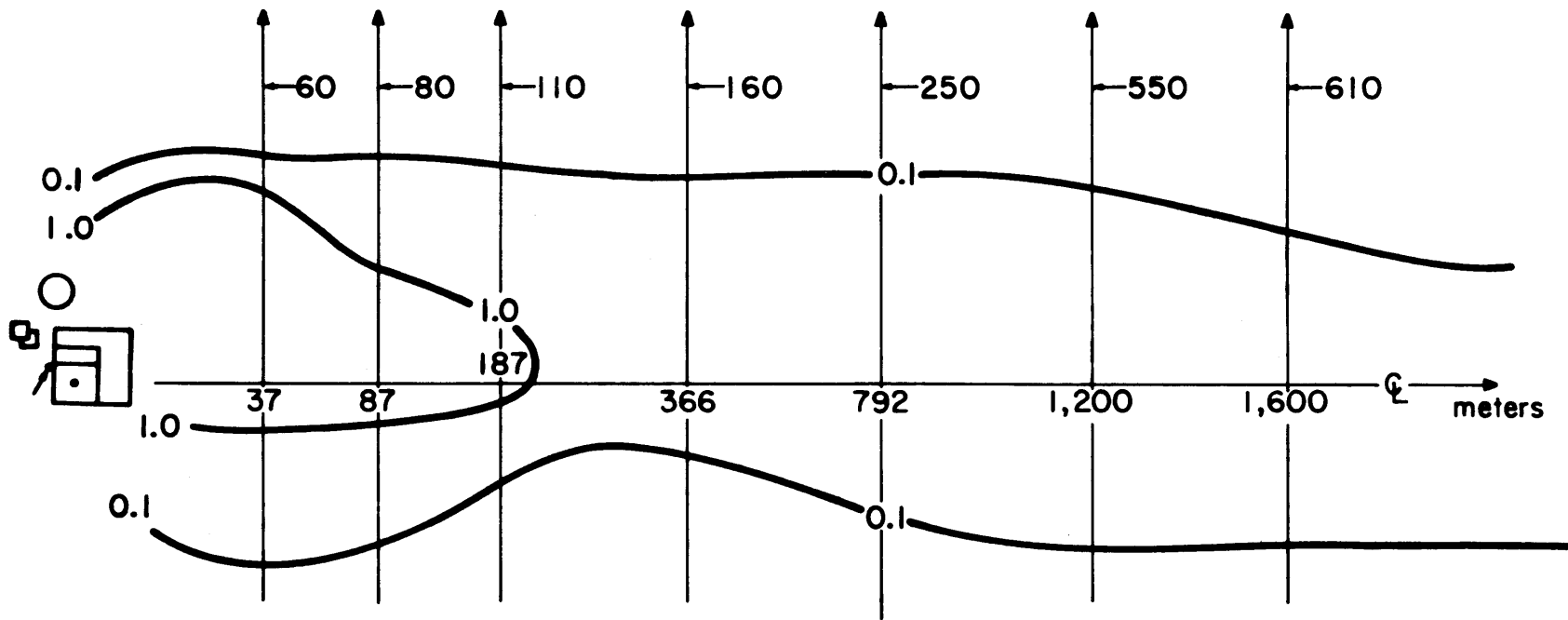

Figure 49. Diffusion isopleths, $\theta = 315^\circ$
slightly stable, ground release

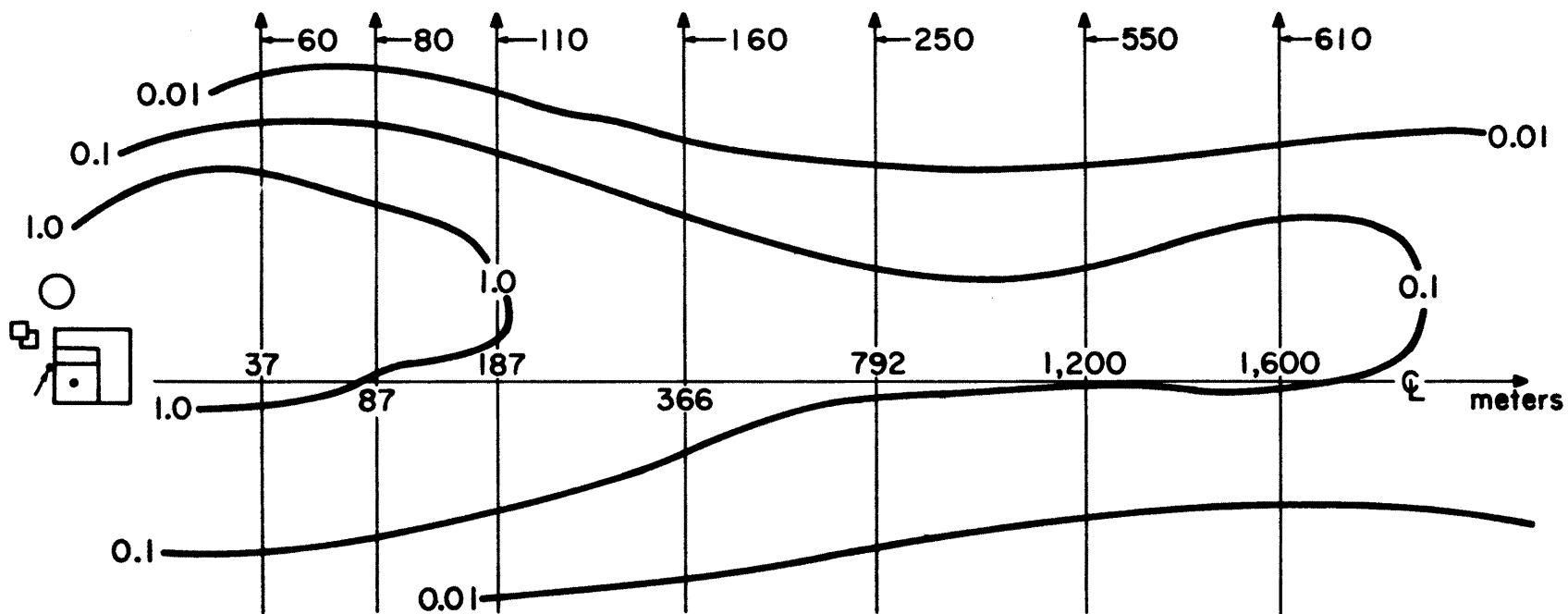

Figure 50. Diffusion isopleths, $\theta = 315^\circ$
strongly stable, ground release

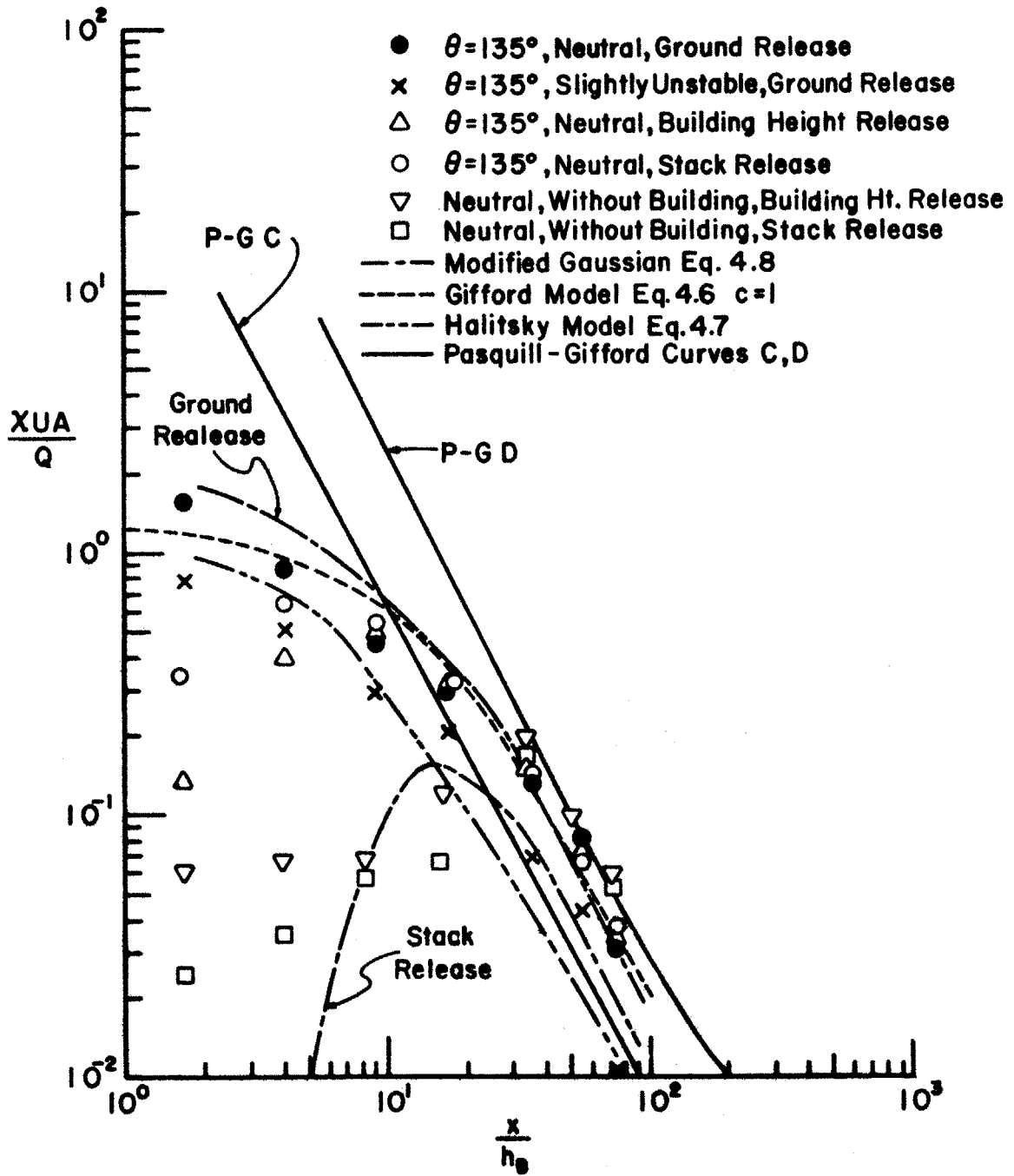

Figure 51. Comparison of observed data with prediction equations

TABLES

TABLE I. Comparison of Modeling Parameters for Model and Prototype

<u>Parameter</u>	<u>Model</u>	<u>Prototype</u>
z_o/h_B	0.0018	0.0018
δ/h_B	10	13
Re	12,000	10,000,000
u_*/u_h	0.064	0.06
h_s/h_B	0,1.0,1.2	0,1.0,1.2
Power law exponent p (from data)	.12,.16,.22,.42	-, .15, .35, .52
Power law exponent p (Eq. (2.8))	.13,.17,.23,.67	
Sampling grid X/h_B	1.5-70	1.5-70
<u>ATMOSPHERIC STABILITY</u>	*PG Ri_B h_B/L	*PG Ri_B h_B/L
stable	F-G 0.85 1.69	F-G 1.1 1.29
moderately stable	E 0.17 0.45	- - -
neutral	C-D 0 0	C-D 0 0
unstable	B -0.44 -0.68	B -0.63 -1.08

* Pasquill-Gifford stability category

TABLE II. Key

θ	=	Run number
0°		1
45°		2
90°		3
135°		4
180°		5
225°		6
270°		7
315°		8

G = ground level release

B = building height release

S = stack height release

TABLE III. Data, Slightly Unstable

RUN NUMBER 16
 STABILITY -e
 RELEASE HEIGHT (METERS) 0.00
 WIND DIRECTION 0

SAMPLE POSITION (METERS)			CONCENTRATION COEFFICIENT
X	Y	Z	
37.4	28.4	0.0	.36E+00
37.4	14.2	0.0	.99E+00
37.4	0.0	0.0	.19E+00
37.4	-14.2	0.0	.84E-01
37.4	-28.4	0.0	.65E-01
87.0	30.5	0.0	.11E+01
87.0	15.2	0.0	.51E+00
87.0	0.0	0.0	.19E+00
87.0	-15.2	0.0	.14E-01
87.0	-30.5	0.0	.15E-01
187.0	65.0	0.0	.13E-01
187.0	32.5	0.0	.10E-01
187.0	0.0	0.0	.94E-01
187.0	-32.5	0.0	.13E-01
187.0	-65.0	0.0	.73E-02
366.0	64.0	0.0	.10E+00
366.0	32.0	0.0	.97E-01
366.0	0.0	0.0	.91E-01
366.0	-32.0	0.0	.29E-01
366.0	-64.0	0.0	.21E-01
792.0	138.0	0.0	.97E-02
792.0	69.0	0.0	.70E-01
792.0	0.0	0.0	.54E-01
792.0	-69.0	0.0	.17E-01
792.0	-138.0	0.0	.68E-02
1200.0	213.4	0.0	.39E-02
1200.0	106.7	0.0	.63E-02
1200.0	0.0	0.0	.92E-02
1200.0	-106.7	0.0	.73E-02
1200.0	-213.4	0.0	.45E-02
1600.0	224.2	0.0	.13E-02
1600.0	112.1	0.0	.13E-02
1600.0	0.0	0.0	.13E-02
1600.0	-112.1	0.0	.13E-02
1600.0	-224.2	0.0	.13E-02
87.0	0.0	17.8	.66E-02
87.0	0.0	39.4	.71E-02
187.0	0.0	17.8	.11E+01
187.0	0.0	39.4	.34E-01
366.0	0.0	17.8	.36E-01
366.0	0.0	39.4	.44E-01
792.0	0.0	30.5	.26E-01
792.0	0.0	50.8	.20E-01
1200.0	0.0	10.8	.30E-01
1200.0	0.0	30.5	.89E-02
1600.0	0.0	31.1	.21E-01

MAXIMUM VALUE

.11E+01

RUN NUMBER 18
 STABILITY B
 RELEASE HEIGHT (METERS) 22.60
 WIND DIRECTION 0

SAMPLE POSITION (METERS)			CONCENTRATION COEFFICIENT
X	Y	Z	
37.4	28.4	0.0	.12E+00
37.4	14.2	0.0	.12E+01
37.4	0.0	0.0	.12E+01
37.4	-14.2	0.0	.36E+00
37.4	-28.4	0.0	.37E+00
87.0	30.5	0.0	.30E+00
87.0	15.2	0.0	.96E+00
87.0	0.0	0.0	.81E+00
87.0	-15.2	0.0	.32E-01
87.0	-30.5	0.0	.69E-01
187.0	65.0	0.0	.14E-01
187.0	32.5	0.0	.16E-01
187.0	0.0	0.0	.26E+00
187.0	-32.5	0.0	.22E-01
187.0	-65.0	0.0	.54E-02
366.0	64.0	0.0	.79E-01
366.0	32.0	0.0	.13E+00
366.0	0.0	0.0	.18E+00
366.0	-32.0	0.0	.62E-01
366.0	-64.0	0.0	.41E-01
792.0	138.0	0.0	.64E-02
792.0	69.0	0.0	.72E-01
792.0	0.0	0.0	.76E-01
792.0	-69.0	0.0	.23E-01
792.0	-138.0	0.0	.64E-02
1200.0	213.4	0.0	.25E-02
1200.0	106.7	0.0	.25E-02
1200.0	0.0	0.0	.48E-02
1200.0	-106.7	0.0	.48E-02
1200.0	-213.4	0.0	.25E-02
1600.0	224.2	0.0	.16E-02
1600.0	112.1	0.0	.16E-02
1600.0	0.0	0.0	.16E-02
1600.0	-112.1	0.0	.16E-02
1600.0	-224.2	0.0	.16E-02
87.0	0.0	17.8	.38E-02
87.0	0.0	39.4	.60E-02
187.0	0.0	17.8	.23E+00
187.0	0.0	39.4	.43E-01
366.0	0.0	17.8	.51E-01
366.0	0.0	39.4	.47E-01
792.0	0.0	30.5	.27E-01
792.0	0.0	50.8	.18E-01
1200.0	0.0	19.8	.34E-01
1200.0	0.0	30.5	.32E-02
1600.0	0.0	31.1	.25E-01

MAXIMUM VALUE

.12E+01

RUN NUMBER 15
 STABILITY R
 RELEASE HEIGHT (METERS) 29.00
 WIND DIRECTION 0

SAMPLE POSITION (METERS)			CONCENTRATION COEFFICIENT
X	Y	Z	
37.4	26.4	0.0	.57E-01
37.4	14.2	0.0	.22E+00
37.4	0.0	0.0	.24E+00
37.4	-14.2	0.0	.70E-01
37.4	-28.4	0.0	.15E-01
87.0	30.5	0.0	.13E-01
87.0	15.2	0.0	.35E+00
87.0	0.0	0.0	.40E+00
87.0	-15.2	0.0	.71E-01
87.0	-30.5	0.0	.22E-01
187.0	65.0	0.0	.32E-02
187.0	32.5	0.0	.32E-02
187.0	0.0	0.0	.23E+00
187.0	-32.5	0.0	.28E-01
187.0	-65.0	0.0	.41E-02
366.0	64.0	0.0	.52E-01
366.0	32.0	0.0	.15E+00
366.0	0.0	0.0	.23E+00
366.0	-32.0	0.0	.12E+00
366.0	-64.0	0.0	.43E-01
792.0	138.0	0.0	.51E-02
792.0	69.0	0.0	.59E-01
792.0	0.0	0.0	.72E-01
792.0	-69.0	0.0	.24E-01
792.0	-138.0	0.0	.73E-02
1200.0	213.4	0.0	.16E-02
1200.0	106.7	0.0	.16E-02
1200.0	0.0	0.0	.41E-02
1200.0	-106.7	0.0	.22E-02
1200.0	-213.4	0.0	.16E-02
1600.0	224.2	0.0	.16E-02
1600.0	112.1	0.0	.16E-02
1600.0	0.0	0.0	.16E-02
1600.0	-112.1	0.0	.16E-02
1600.0	-224.2	0.0	.16E-02
87.0	0.0	17.8	.16E-02
87.0	0.0	39.4	.22E-02
187.0	0.0	17.8	.27E+00
187.0	0.0	39.4	.59E-01
366.0	0.0	17.8	.51E-01
366.0	0.0	39.4	.43E-01
792.0	0.0	30.5	.27E-01
792.0	0.0	50.8	.12E-01
1200.0	0.0	10.8	.30E-01
1200.0	0.0	30.5	.16E-02
1600.0	0.0	31.1	.25E-01

MAXIMUM VALUE

.40E+00

RUN NUMBER 26
 STABILITY 8
 RELEASE HEIGHT (METERS) 0.00
 WIND DIRECTION 45

SAMPLE POSITION (METERS)			CONCENTRATION COEFFICIENT
X	Y	Z	
37.4	28.4	0.0	.49E-01
37.4	14.2	0.0	.10E+01
37.4	0.0	0.0	.15E+01
37.4	-14.2	0.0	.25E+01
37.4	-28.4	0.0	.73E-02
87.0	30.5	0.0	.12E+00
87.0	15.2	0.0	.50E+00
87.0	0.0	0.0	.78E+00
87.0	-15.2	0.0	.18E-01
87.0	-30.5	0.0	.84E-02
187.0	65.0	0.0	.89E-02
187.0	32.5	0.0	.81E-02
187.0	0.0	0.0	.17E+00
187.0	-32.5	0.0	.13E-01
187.0	-65.0	0.0	.71E-02
366.0	64.0	0.0	.40E-01
366.0	32.0	0.0	.11E+00
366.0	0.0	0.0	.21E+00
366.0	-32.0	0.0	.91E-01
366.0	-64.0	0.0	.17E-01
792.0	138.0	0.0	.10E-01
792.0	69.0	0.0	.58E-01
792.0	0.0	0.0	.80E-01
792.0	-69.0	0.0	.23E-01
792.0	-138.0	0.0	.24E-02
1200.0	213.4	0.0	.60E-02
1200.0	106.7	0.0	.58E-02
1200.0	0.0	0.0	.55E-02
1200.0	-106.7	0.0	.16E-02
1200.0	-213.4	0.0	.16E-02
1600.0	224.2	0.0	.13E-02
1600.0	112.1	0.0	.13E-02
1600.0	0.0	0.0	.13E-02
1600.0	-112.1	0.0	.13E-02
1600.0	-224.2	0.0	.13E-02
87.0	0.0	17.8	.60E-02
87.0	0.0	39.4	.23E-01
187.0	0.0	17.8	.32E+00
187.0	0.0	39.4	.83E-01
366.0	0.0	17.8	.44E-01
366.0	0.0	39.4	.59E-01
792.0	0.0	30.5	.34E-01
792.0	0.0	50.8	.24E-01
1200.0	0.0	10.8	.28E-01
1200.0	0.0	30.5	.79E-02
1600.0	0.0	31.1	.21E-01

MAXIMUM VALUE

.15E+01

RUN NUMBER 28
 STABILITY B
 RELEASE HEIGHT (METERS) 22.60
 WIND DIRECTION 45

SAMPLE POSITION (METERS)			CONCENTRATION COEFFICIENT
X	Y	Z	
37.4	28.4	0.0	.34E-01
37.4	14.2	0.0	.26E-01
37.4	0.0	0.0	.26E+00
37.4	-14.2	0.0	.64E-01
37.4	-28.4	0.0	.99E-02
87.0	30.5	0.0	.21E-01
87.0	15.2	0.0	.13E+00
87.0	0.0	0.0	.28E+00
87.0	-15.2	0.0	.58E-01
87.0	-30.5	0.0	.13E-01
187.0	65.0	0.0	.29E-02
187.0	32.5	0.0	.25E-02
187.0	0.0	0.0	.19E+00
187.0	-32.5	0.0	.23E-01
187.0	-65.0	0.0	.25E-02
366.0	64.0	0.0	.33E-01
366.0	32.0	0.0	.11E+00
366.0	0.0	0.0	.21E+00
366.0	-32.0	0.0	.12E+00
366.0	-64.0	0.0	.17E-01
792.0	138.0	0.0	.54E-02
792.0	69.0	0.0	.66E-01
792.0	0.0	0.0	.91E-01
792.0	-69.0	0.0	.23E-01
792.0	-138.0	0.0	.76E-02
1200.0	213.4	0.0	.35E-02
1200.0	106.7	0.0	.22E-02
1200.0	0.0	0.0	.19E-02
1200.0	-106.7	0.0	.13E-02
1200.0	-213.4	0.0	.35E-02
1600.0	224.2	0.0	.16E-02
1600.0	112.1	0.0	.16E-02
1600.0	0.0	0.0	.16E-02
1600.0	-112.1	0.0	.16E-02
1600.0	-224.2	0.0	.16E-02
87.0	0.0	17.8	.25E-02
87.0	0.0	39.4	.52E-01
187.0	0.0	17.8	.37E-01
187.0	0.0	39.4	.14E+00
366.0	0.0	17.8	.51E-01
366.0	0.0	39.4	.80E-01
792.0	0.0	30.5	.39E-01
792.0	0.0	50.8	.28E-01
1200.0	0.0	10.8	.38E-01
1200.0	0.0	30.5	.35E-02
1600.0	0.0	31.1	.27E-01

MAXIMUM VALUE

.28E+00

RUN NUMBER 25
 STABILITY R
 RELEASE HEIGHT (METERS) 29.00
 WIND DIRECTION 45

SAMPLE POSITION (METERS)			CONCENTRATION COEFFICIENT
X	Y	Z	
37.4	28.4	0.0	.12E-01
37.4	14.2	0.0	.15E-01
37.4	0.0	0.0	.92E-01
37.4	-14.2	0.0	.25E-01
37.4	-28.4	0.0	.10E-01
87.0	30.5	0.0	.12E-01
87.0	15.2	0.0	.53E-01
87.0	0.0	0.0	.12E+00
87.0	-15.2	0.0	.47E-01
87.0	-30.5	0.0	.60E-02
187.0	65.0	0.0	0.
187.0	32.5	0.0	.41E-02
187.0	0.0	0.0	.11E+00
187.0	-32.5	0.0	.22E-01
187.0	-65.0	0.0	.38E-02
366.0	64.0	0.0	.22E-01
366.0	32.0	0.0	.49E-01
366.0	0.0	0.0	.16E+00
366.0	-32.0	0.0	.75E-01
366.0	-64.0	0.0	.17E-01
792.0	138.0	0.0	.41E-02
792.0	69.0	0.0	.46E-01
792.0	0.0	0.0	.73E-01
792.0	-69.0	0.0	.18E-01
792.0	-138.0	0.0	.48E-02
1200.0	213.4	0.0	.11E-01
1200.0	106.7	0.0	.22E-02
1200.0	0.0	0.0	.35E-02
1200.0	-106.7	0.0	.45E-02
1200.0	-213.4	0.0	.41E-02
1600.0	224.2	0.0	.16E-02
1600.0	112.1	0.0	.16E-02
1600.0	0.0	0.0	.16E-02
1600.0	-112.1	0.0	.16E-02
1600.0	-224.2	0.0	.16E-02
87.0	0.0	17.8	.32E-02
87.0	0.0	39.4	.14E-01
187.0	0.0	17.8	.27E+00
187.0	0.0	39.4	.14E+00
366.0	0.0	17.8	.70E-01
366.0	0.0	39.4	.77E-01
792.0	0.0	30.5	.33E-01
792.0	0.0	50.8	.32E-01
1200.0	0.0	10.8	.34E-01
1200.0	0.0	30.5	.22E-02
1600.0	0.0	31.1	.25E-01

MAXIMUM VALUE

.27E+00

RUN NUMBER 30
 STABILITY R
 RELEASE HEIGHT (METERS) 0.00
 WIND DIRECTION 90

SAMPLE POSITION (METERS)			CONCENTRATION COEFFICIENT
X	Y	Z	
37.4	28.4	0.0	.66E+00
37.4	14.2	0.0	.12E+01
37.4	0.0	0.0	.93E+00
37.4	-14.2	0.0	.42E+00
37.4	-28.4	0.0	.74E-01
87.0	30.5	0.0	.12E+00
87.0	15.2	0.0	.41E+00
87.0	0.0	0.0	.45E+00
87.0	-15.2	0.0	.17E-01
87.0	-30.5	0.0	.43E-01
187.0	65.0	0.0	.17E-01
187.0	32.5	0.0	.45E-01
187.0	0.0	0.0	.27E+00
187.0	-32.5	0.0	.14E-01
187.0	-65.0	0.0	.37E-02
366.0	64.0	0.0	.37E-01
366.0	32.0	0.0	.88E-01
366.0	0.0	0.0	.14E+00
366.0	-32.0	0.0	.61E-01
366.0	-64.0	0.0	.43E-01
792.0	138.0	0.0	.11E-01
792.0	69.0	0.0	.45E-01
792.0	0.0	0.0	.65E-01
792.0	-69.0	0.0	.30E-01
792.0	-138.0	0.0	.29E-02
1200.0	213.4	0.0	.63E-02
1200.0	106.7	0.0	.63E-02
1200.0	0.0	0.0	.55E-02
1200.0	-106.7	0.0	.63E-02
1200.0	-213.4	0.0	.81E-02
1600.0	224.2	0.0	.13E-02
1600.0	112.1	0.0	.13E-02
1600.0	0.0	0.0	.13E-02
1600.0	-112.1	0.0	.13E-02
1600.0	-224.2	0.0	.13E-02
87.0	0.0	17.8	.55E-02
87.0	0.0	39.4	.25E-01
187.0	0.0	17.8	.20E+00
187.0	0.0	39.4	.17E+00
366.0	0.0	17.8	.54E-01
366.0	0.0	39.4	.44E-01
792.0	0.0	30.5	.33E-01
792.0	0.0	50.8	.21E-01
1200.0	0.0	13.8	.20E-01
1200.0	0.0	30.5	.60E-02
1600.0	0.0	31.1	.16E-01

MAXIMUM VALUE

.12E+01

RUN NUMBER 38
 STABILITY B
 RELEASE HEIGHT (METERS) 22.60
 WIND DIRECTION 90

SAMPLE POSITION (METERS)			CONCENTRATION COEFFICIENT
X	Y	Z	
37.4	28.4	0.0	.64E-01
37.4	14.2	0.0	.17E+00
37.4	0.0	0.0	.75E+00
37.4	-14.2	0.0	.44E+00
37.4	-28.4	0.0	.66E-01
87.0	30.5	0.0	.42E-01
87.0	15.2	0.0	.32E+00
87.0	0.0	0.0	.52E+00
87.0	-15.2	0.0	.26E-01
87.0	-30.5	0.0	.48E-01
187.0	65.0	0.0	.11E-01
187.0	32.5	0.0	.39E-01
187.0	0.0	0.0	.25E+00
187.0	-32.5	0.0	.13E-01
187.0	-65.0	0.0	.19E-02
366.0	64.0	0.0	.23E-01
366.0	32.0	0.0	.64E-01
366.0	0.0	0.0	.14E+00
366.0	-32.0	0.0	.64E-01
366.0	-64.0	0.0	.42E-01
792.0	138.0	0.0	.64E-02
792.0	69.0	0.0	.38E-01
792.0	0.0	0.0	.51E-01
792.0	-69.0	0.0	.36E-01
792.0	-138.0	0.0	.99E-02
1200.0	213.4	0.0	.29E-02
1200.0	106.7	0.0	.32E-02
1200.0	0.0	0.0	.35E-02
1200.0	-106.7	0.0	.29E-02
1200.0	-213.4	0.0	.25E-02
1600.0	224.2	0.0	.16E-02
1600.0	112.1	0.0	.16E-02
1600.0	0.0	0.0	.16E-02
1600.0	-112.1	0.0	.16E-02
1600.0	-224.2	0.0	.16E-02
87.0	0.0	17.8	.22E-02
87.0	0.0	39.4	.50E-01
187.0	0.0	17.8	.19E+00
187.0	0.0	39.4	.74E-01
366.0	0.0	17.8	.54E-01
366.0	0.0	39.4	.48E-01
792.0	0.0	30.5	.35E-01
792.0	0.0	50.8	.21E-01
1200.0	0.0	10.8	.21E-01
1200.0	0.0	30.5	.29E-02
1600.0	0.0	31.1	.19E-01

MAXIMUM VALUE

.75E+00

RUN NUMBER 3S
 STABILITY P
 RELEASE HEIGHT (METERS) 29.00
 WIND DIRECTION 90

SAMPLE POSITION (METERS)			CONCENTRATION COEFFICIENT
X	Y	Z	
37.4	28.4	0.0	.17E-01
37.4	14.2	0.0	.35E-01
37.4	0.0	0.0	.18E+00
37.4	-14.2	0.0	.11E+00
37.4	-28.4	0.0	.20E-01
87.0	30.5	0.0	.54E-01
87.0	15.2	0.0	.48E+00
87.0	0.0	0.0	.54E+00
87.0	-15.2	0.0	.70E-01
87.0	-30.5	0.0	.34E-01
187.0	65.0	0.0	.26E-01
187.0	32.5	0.0	.72E-01
187.0	0.0	0.0	.36E+00
187.0	-32.5	0.0	.12E-01
187.0	-65.0	0.0	.25E-02
366.0	64.0	0.0	.33E-01
366.0	32.0	0.0	.83E-01
366.0	0.0	0.0	.78E-01
366.0	-32.0	0.0	.16E+00
366.0	-64.0	0.0	.34E-01
792.0	138.0	0.0	.92E-02
792.0	69.0	0.0	.55E-01
792.0	0.0	0.0	.68E-01
792.0	-69.0	0.0	.28E-01
792.0	-138.0	0.0	.80E-02
1200.0	213.4	0.0	.51E-02
1200.0	106.7	0.0	.25E-02
1200.0	0.0	0.0	.13E-02
1200.0	-106.7	0.0	.16E-02
1200.0	-213.4	0.0	.25E-02
1600.0	224.2	0.0	.16E-02
1600.0	112.1	0.0	.16E-02
1600.0	0.0	0.0	.16E-02
1600.0	-112.1	0.0	.16E-02
1600.0	-224.2	0.0	.16E-02
87.0	0.0	17.8	.48E-02
87.0	0.0	39.4	.19E-02
187.0	0.0	17.8	.23E+00
187.0	0.0	39.4	.22E+00
366.0	0.0	17.8	.49E-01
366.0	0.0	39.4	.45E-01
792.0	0.0	30.5	.26E-01
792.0	0.0	50.8	.23E-01
1200.0	0.0	10.8	.33E-01
1200.0	0.0	30.5	.76E-02
1600.0	0.0	31.1	.25E-01

MAXIMUM VALUE

.54E+00

RUN NUMBER 46
 STABILITY B
 RELEASE HEIGHT (METERS) 0.00
 WIND DIRECTION 135

SAMPLE POSITION (METERS)			CONCENTRATION COEFFICIENT
X	Y	Z	
37.4	28.4	0.0	.37E-01
37.4	14.2	0.0	.65E+00
37.4	0.0	0.0	.80E+00
37.4	-14.2	0.0	.55E+00
37.4	-28.4	0.0	.16E-01
87.0	30.5	0.0	.89E-01
87.0	15.2	0.0	.44E+00
87.0	0.0	0.0	.47E+00
87.0	-15.2	0.0	.33E-01
87.0	-30.5	0.0	.24E-01
187.0	65.0	0.0	.17E-01
187.0	32.5	0.0	.23E-01
187.0	0.0	0.0	.29E+00
187.0	-32.5	0.0	.30E-01
187.0	-65.0	0.0	.71E-02
366.0	64.0	0.0	.59E-01
366.0	32.0	0.0	.17E+00
366.0	0.0	0.0	.14E+00
366.0	-32.0	0.0	.62E-01
366.0	-64.0	0.0	.19E-01
792.0	138.0	0.0	.66E-02
792.0	69.0	0.0	.54E-01
792.0	0.0	0.0	.53E-01
792.0	-69.0	0.0	.18E-01
792.0	-138.0	0.0	.12E-01
1200.0	213.4	0.0	.34E-02
1200.0	106.7	0.0	.66E-02
1200.0	0.0	0.0	.45E-02
1200.0	-106.7	0.0	.79E-02
1200.0	-213.4	0.0	.76E-02
1600.0	224.2	0.0	.13E-02
1600.0	112.1	0.0	.13E-02
1600.0	0.0	0.0	.13E-02
1600.0	-112.1	0.0	.13E-02
1600.0	-224.2	0.0	.13E-02
87.0	0.0	17.8	.81E-02
87.0	0.0	39.4	.81E-02
187.0	0.0	17.8	.28E+00
187.0	0.0	39.4	.99E-01
366.0	0.0	17.8	.62E-01
366.0	0.0	39.4	.56E-01
792.0	0.0	30.5	.32E-01
792.0	0.0	50.8	.23E-01
1200.0	0.0	10.8	.31E-01
1200.0	0.0	30.5	.79E-02
1600.0	0.0	31.1	.21E-01

MAXIMUM VALUE

.80E+00

RUN NUMBER 48
 STABILITY 8
 RELEASE HEIGHT (METERS) 22.60
 WIND DIRECTION 135

SAMPLE POSITION (METERS)			CONCENTRATION COEFFICIENT
X	Y	Z	
37.4	28.4	0.0	.23E-01
37.4	14.2	0.0	.24E+00
37.4	0.0	0.0	.34E+00
37.4	-14.2	0.0	.14E+00
37.4	-28.4	0.0	.12E-01
87.0	31.5	0.0	.61E-01
87.0	15.2	0.0	.36E+00
87.0	0.0	0.0	.36E+00
87.0	-15.2	0.0	.75E-01
87.0	-30.5	0.0	.23E-01
187.0	65.0	0.0	.11E-01
187.0	32.5	0.0	.17E-01
187.0	0.0	0.0	.28E+00
187.0	-32.5	0.0	.29E-01
187.0	-65.0	0.0	.48E-02
366.0	64.0	0.0	.59E-01
366.0	32.0	0.0	.17E+00
366.0	0.0	0.0	.14E+00
366.0	-32.0	0.0	.63E-01
366.0	-64.0	0.0	.22E-01
792.0	138.0	0.0	.32E-02
792.0	69.0	0.0	.61E-01
792.0	0.0	0.0	.64E-01
792.0	-69.0	0.0	.19E-01
792.0	-138.0	0.0	.16E-01
1200.0	213.4	0.0	.10E-01
1200.0	106.7	0.0	.19E-02
1200.0	0.0	0.0	.16E-02
1200.0	-106.7	0.0	.29E-02
1200.0	-213.4	0.0	.38E-02
1600.0	224.2	0.0	.16E-02
1600.0	112.1	0.0	.16E-02
1600.0	0.0	0.0	.16E-02
1600.0	-112.1	0.0	.16E-02
1600.0	-224.2	0.0	.16E-02
87.0	0.0	17.8	.29E-02
87.0	0.0	39.4	.35E-02
187.0	0.0	17.8	.27E+00
187.0	0.0	39.4	.12E+00
366.0	0.0	17.8	.59E-01
366.0	0.0	39.4	.63E-01
792.0	0.0	31.5	.33E-01
792.0	0.0	50.8	.25E-01
1200.0	0.0	10.8	.34E-01
1200.0	0.0	30.5	.38E-02
1600.0	0.0	31.1	.25E-01

MAXIMUM VALUE

.36E+00

RUN NUMBER 45
 STABILITY B
 RELEASE HEIGHT (METERS) 29.00
 WIND DIRECTION 135

SAMPLE POSITION (METERS)			CONCENTRATION COEFFICIENT
X	Y	Z	
37.4	28.4	0.0	.29E-01
37.4	14.2	0.0	.19E+00
37.4	0.0	0.0	.19E+00
37.4	-14.2	0.0	.78E-01
37.4	-28.4	0.0	.12E-01
87.0	30.5	0.0	.81E-01
87.0	15.2	0.0	.43E+00
87.0	0.0	0.0	.23E+00
87.0	-15.2	0.0	.55E-01
87.0	-30.5	0.0	.17E-01
187.0	65.0	0.0	.80E-02
187.0	32.5	0.0	.17E-01
187.0	0.0	0.0	.25E+00
187.0	-32.5	0.0	.24E-01
187.0	-65.0	0.0	.51E-02
366.0	64.0	0.0	.71E-01
366.0	32.0	0.0	.12E+00
366.0	0.0	0.0	.12E+00
366.0	-32.0	0.0	.55E-01
366.0	-64.0	0.0	.18E-01
792.0	138.0	0.0	.45E-02
792.0	69.0	0.0	.64E-01
792.0	0.0	0.0	.66E-01
792.0	-69.0	0.0	.18E-01
792.0	-138.0	0.0	.18E-01
1200.0	213.4	0.0	.16E-02
1200.0	106.7	0.0	.16E-02
1200.0	0.0	0.0	.16E-02
1200.0	-106.7	0.0	.16E-02
1200.0	-213.4	0.0	.16E-02
1600.0	224.2	0.0	.16E-02
1600.0	112.1	0.0	.16E-02
1600.0	0.0	0.0	.16E-02
1600.0	-112.1	0.0	.16E-02
1600.0	-224.2	0.0	.16E-02
87.0	0.0	17.8	.25E-02
87.0	0.0	39.4	.51E-02
187.0	0.0	17.8	.27E+00
187.0	0.0	39.4	.27E+00
366.0	0.0	17.8	.12E+00
366.0	0.0	39.4	.35E-01
792.0	0.0	30.5	.95E-02
792.0	0.0	50.8	.36E-01
1200.0	0.0	10.8	.31E-01
1200.0	0.0	30.5	.34E-01
1600.0	0.0	31.1	.25E-01

MAXIMUM VALUE

.43E+00

RUN NUMBER 56
 STABILITY B
 RELEASE HEIGHT (METERS) 1.00
 WIND DIRECTION 180

SAMPLE POSITION (METERS)			CONCENTRATION COEFFICIENT
X	Y	Z	
37.4	28.4	0.0	.19E-01
37.4	14.2	0.0	.87E-01
37.4	0.0	0.0	.68E+00
37.4	-14.2	0.0	.16E+01
37.4	-28.4	0.0	.22E+01
87.0	30.5	0.0	.81E-01
87.0	15.2	0.0	.31E+00
87.0	0.0	0.0	.57E+00
87.0	-15.2	0.0	.20E-01
87.0	-30.5	0.0	.34E+00
187.0	65.0	0.0	.30E-01
187.0	32.5	0.0	.10E+00
187.0	0.0	0.0	.35E+00
187.0	-32.5	0.0	.74E-02
187.0	-65.0	0.0	.63E-02
366.0	64.0	0.0	.54E-01
366.0	32.0	0.0	.13E+00
366.0	0.0	0.0	.19E+00
366.0	-32.0	0.0	.11E+00
366.0	-64.0	0.0	.82E-01
792.0	138.0	0.0	.98E-02
792.0	69.0	0.0	.46E-01
792.0	0.0	0.0	.79E-01
792.0	-69.0	0.0	.34E-01
792.0	-138.0	0.0	.30E-02
1200.0	213.4	0.0	.33E-02
1200.0	106.7	0.0	.74E-02
1200.0	0.0	0.0	.46E-02
1200.0	-106.7	0.0	.16E-02
1200.0	-213.4	0.0	.86E-02
1600.0	224.2	0.0	.12E-02
1600.0	112.1	0.0	.12E-02
1600.0	0.0	0.0	.12E-02
1600.0	-112.1	0.0	.12E-02
1600.0	-224.2	0.0	.12E-02
87.0	0.0	17.8	.74E-02
87.0	0.0	39.4	.70E-02
187.0	0.0	17.8	.25E+00
187.0	0.0	39.4	.93E-01
366.0	0.0	17.8	.76E-01
366.0	0.0	39.4	.39E-01
792.0	0.0	30.5	.37E-01
792.0	0.0	50.8	.18E-01
1200.0	0.0	10.8	.23E-01
1200.0	0.0	30.5	.13E-01
1600.0	0.0	31.1	.19E-01

MAXIMUM VALUE

.22E+01

RUN NUMBER 50
 STABILITY E
 RELEASE HEIGHT (METERS) 22.60
 WIND DIRECTION 180

SAMPLE POSITION (METERS)			CONCENTRATION COEFFICIENT
X	Y	Z	
37.4	28.4	0.0	.28E-01
37.4	14.2	0.0	.21E+00
37.4	0.0	0.0	.13E+01
37.4	-14.2	0.0	.15E+01
37.4	-28.4	0.0	.48E+00
87.0	30.5	0.0	.19E+00
87.0	15.2	0.0	.81E+00
87.0	0.0	0.0	.11E+01
87.0	-15.2	0.0	.23E-01
87.0	-30.5	0.0	.13E+00
187.0	65.0	0.0	.20E-01
187.0	32.5	0.0	.13E+00
187.0	0.0	0.0	.47E+00
187.0	-32.5	0.0	.34E-02
187.0	-65.0	0.0	.31E-02
366.0	64.0	0.0	.90E-01
366.0	32.0	0.0	.18E+00
366.0	0.0	0.0	.20E+00
366.0	-32.0	0.0	.82E-01
366.0	-64.0	0.0	.57E-01
792.0	138.0	0.0	.11E-01
792.0	69.0	0.0	.63E-01
792.0	0.0	0.0	.74E-01
792.0	-69.0	0.0	.26E-01
792.0	-138.0	0.0	.76E-02
1200.0	213.4	0.0	.42E-02
1200.0	106.7	0.0	.76E-02
1200.0	0.0	0.0	.34E-02
1200.0	-106.7	0.0	.14E-02
1200.0	-213.4	0.0	.51E-02
1600.0	224.2	0.0	.14E-02
1600.0	112.1	0.0	.14E-02
1600.0	0.0	0.0	.14E-02
1600.0	-112.1	0.0	.14E-02
1600.0	-224.2	0.0	.14E-02
87.0	0.0	17.8	.59E-02
87.0	0.0	39.4	.85E-02
187.0	0.0	17.8	.23E+00
187.0	0.0	39.4	.11E+00
366.0	0.0	17.8	.65E-01
366.0	0.0	39.4	.38E-01
792.0	0.0	30.5	.32E-01
792.0	0.0	51.8	.17E-01
1200.0	0.0	10.8	.31E-01
1200.0	0.0	30.5	.87E-02
1600.0	0.0	31.1	.23E-01

MAXIMUM VALUE

.15E+01

RUN NUMBER 55
 STABILITY B
 RELEASE HEIGHT (METERS) 29.00
 WIND DIRECTION 180

SAMPLE POSITION (METERS)			CONCENTRATION COEFFICIENT
X	Y	Z	
37.4	28.4	0.0	.14E-01
37.4	14.2	0.0	.65E-01
37.4	0.0	0.0	.31E+00
37.4	-14.2	0.0	.16E+00
37.4	-28.4	0.0	.74E-01
87.0	30.5	0.0	.11E+00
87.0	15.2	0.0	.47E+01
87.0	0.0	0.0	.45E+00
87.0	-15.2	0.0	.12E+00
87.0	-30.5	0.0	.65E-01
187.0	65.0	0.0	.14E-01
187.0	32.5	0.0	.30E-01
187.0	0.0	0.0	.36E+00
187.0	-32.5	0.0	.25E-01
187.0	-65.0	0.0	.59E-02
366.0	64.0	0.0	.10E+00
366.0	32.0	0.0	.13E+00
366.0	0.0	0.0	.18E+00
366.0	-32.0	0.0	.76E-01
366.0	-64.0	0.0	.29E-01
792.0	138.0	0.0	.79E-02
792.0	69.0	0.0	.72E-01
792.0	0.0	0.0	.77E-01
792.0	-69.0	0.0	.20E-01
792.0	-138.0	0.0	.96E-02
1200.0	213.4	0.0	.59E-02
1200.0	106.7	0.0	.25E-02
1200.0	0.0	0.0	.17E-02
1200.0	-106.7	0.0	.76E-02
1200.0	-213.4	0.0	.28E-02
1600.0	224.2	0.0	.14E-02
1600.0	112.1	0.0	.14E-02
1600.0	0.0	0.0	.14E-02
1600.0	-112.1	0.0	.14E-02
1600.0	-224.2	0.0	.14E-02
87.0	0.0	17.8	.51E-02
87.0	0.0	39.4	.85E-02
187.0	0.0	17.8	.20E+00
187.0	0.0	39.4	.85E-01
366.0	0.0	17.8	.54E-02
366.0	0.0	39.4	.31E-01
792.0	0.0	30.5	.44E-01
792.0	0.0	50.8	.36E-01
1200.0	0.0	10.8	.28E-01
1200.0	0.0	30.5	.17E-01
1600.0	0.0	31.1	.23E-01

MAXIMUM VALUE

.47E+00

RUN NUMBER 66
 STABILITY P
 RELEASE HEIGHT (METERS) 0.00
 WIND DIRECTION 225

SAMPLE POSITION (METERS)			CONCENTRATION COEFFICIENT
X	Y	Z	
37.4	28.4	0.0	.17E-01
37.4	14.2	0.0	.83E+00
37.4	0.0	0.0	.32E+01
37.4	-14.2	0.0	.38E+01
37.4	-28.4	0.0	.13E+00
87.0	30.5	0.0	.93E-01
87.0	15.2	0.0	.42E+00
87.0	0.0	0.0	.74E+00
87.0	-15.2	0.0	.73E-01
87.0	-30.5	0.0	.33E+00
187.0	65.0	0.0	.41E-01
187.0	32.5	0.0	.33E-01
187.0	0.0	0.0	.30E+00
187.0	-32.5	0.0	.70E-01
187.0	-65.0	0.0	.70E-02
366.0	64.0	0.0	.41E-01
366.0	32.0	0.0	.89E-01
366.0	0.0	0.0	.21E+00
366.0	-32.0	0.0	.55E-01
366.0	-64.0	0.0	.90E-01
792.0	138.0	0.0	.11E-01
792.0	69.0	0.0	.46E-01
792.0	0.0	0.0	.80E-01
792.0	-69.0	0.0	.32E-01
792.0	-138.0	0.0	.33E-01
1200.0	213.4	0.0	.14E-01
1200.0	106.7	0.0	.14E-01
1200.0	0.0	0.0	.19E-01
1200.0	-106.7	0.0	.72E-02
1200.0	-213.4	0.0	.33E-02
1600.0	224.2	0.0	.12E-02
1600.0	112.1	0.0	.12E-02
1600.0	0.0	0.0	.12E-02
1600.0	-112.1	0.0	.12E-02
1600.0	-224.2	0.0	.12E-02
87.0	0.0	17.8	.49E-02
87.0	0.0	39.4	.16E-02
187.0	0.0	17.8	.46E-02
187.0	0.0	39.4	.74E-02
366.0	0.0	17.8	.31E-01
366.0	0.0	39.4	.66E-01
792.0	0.0	30.5	.66E-01
792.0	0.0	50.8	.33E-01
1200.0	0.0	10.8	.26E-01
1200.0	0.0	30.5	.93E-02
1600.0	0.0	31.1	.19E-01

MAXIMUM VALUE

.38E+01

RUN NUMBER 68
 STABILITY B
 RELEASE HEIGHT (METERS) 22.60
 WIND DIRECTION 225

SAMPLE POSITION (METERS)			CONCENTRATION COEFFICIENT
X	Y	Z	
37.4	28.4	0.0	.27E-01
37.4	14.2	0.0	.72E+00
37.4	0.0	0.0	.32E+00
37.4	-14.2	0.0	.42E-01
37.4	-28.4	0.0	.48E-01
87.0	30.5	0.0	.12E+00
87.0	15.2	0.0	.44E+00
87.0	0.0	0.0	.56E+00
87.0	-15.2	0.0	.81E-01
87.0	-30.5	0.0	.69E-01
187.0	65.0	0.0	.12E-01
187.0	32.5	0.0	.22E-01
187.0	0.0	0.0	.25E+00
187.0	-32.5	0.0	.37E-01
187.0	-65.0	0.0	.51E-02
366.0	64.0	0.0	.61E-01
366.0	32.0	0.0	.12E+00
366.0	0.0	0.0	.15E+00
366.0	-32.0	0.0	.62E-01
366.0	-64.0	0.0	.51E-01
792.0	138.0	0.0	.70E-02
792.0	69.0	0.0	.56E-01
792.0	0.0	0.0	.68E-01
792.0	-69.0	0.0	.27E-01
792.0	-138.0	0.0	.85E-02
1200.0	213.4	0.0	.12E-01
1200.0	106.7	0.0	.17E-01
1200.0	0.0	0.0	.23E-01
1200.0	-106.7	0.0	.65E-02
1200.0	-213.4	0.0	.28E-02
1600.0	224.2	0.0	.14E-02
1600.0	112.1	0.0	.14E-02
1600.0	0.0	0.0	.14E-02
1600.0	-112.1	0.0	.14E-02
1600.0	-224.2	0.0	.14E-02
87.0	0.0	17.8	.45E-02
87.0	0.0	39.4	.31E-02
187.0	0.0	17.8	.31E-02
187.0	0.0	39.4	.37E-02
366.0	0.0	17.8	.49E-01
366.0	0.0	39.4	.53E-01
792.0	0.0	30.5	.52E-01
792.0	0.0	53.8	.32E-01
1200.0	0.0	10.8	.31E-01
1200.0	0.0	30.5	.11E-01
1600.0	0.0	31.1	.23E-01

MAXIMUM VALUE

.72E+00

RUN NUMBER 6S
 STABILITY P
 RELEASE HEIGHT (METERS) 29.00
 WIND DIRECTION 225

SAMPLE POSITION (METERS)			CONCENTRATION COEFFICIENT
X	Y	Z	
37.4	28.4	0.0	.23E-01
37.4	14.2	0.0	.10E+00
37.4	0.0	0.0	.56E-01
37.4	-14.2	0.0	.24E-01
37.4	-28.4	0.0	.21E-01
87.0	30.5	0.0	.70E-01
87.0	15.2	0.0	.34E+00
87.0	0.0	0.0	.47E+00
87.0	-15.2	0.0	.12E+00
87.0	-30.5	0.0	.12E+00
187.0	65.0	0.0	.17E-01
187.0	32.5	0.0	.23E-01
187.0	0.0	0.0	.33E+00
187.0	-32.5	0.0	.20E-01
187.0	-65.0	0.0	.82E-02
366.0	64.0	0.0	.82E-01
366.0	32.0	0.0	.18E+00
366.0	0.0	0.0	.24E+00
366.0	-32.0	0.0	.66E-01
366.0	-64.0	0.0	.53E-01
792.0	138.0	0.0	.73E-02
792.0	69.0	0.0	.71E-01
792.0	0.0	0.0	.96E-01
792.0	-69.0	0.0	.27E-01
792.0	-138.0	0.0	.51E-02
1200.0	213.4	0.0	.48E-02
1200.0	106.7	0.0	.13E-01
1200.0	0.0	0.0	.90E-02
1200.0	-106.7	0.0	.56E-02
1200.0	-213.4	0.0	.28E-02
1600.0	224.2	0.0	.14E-02
1600.0	112.1	0.0	.14E-02
1600.0	0.0	0.0	.14E-02
1600.0	-112.1	0.0	.14E-02
1600.0	-224.2	0.0	.14E-02
87.0	0.0	17.8	.42E-02
87.0	0.0	39.4	.28E-02
187.0	0.0	17.8	.24E-01
187.0	0.0	39.4	.16E-01
366.0	0.0	17.8	.23E-01
366.0	0.0	39.4	.10E-01
792.0	0.0	30.5	.23E-01
792.0	0.0	50.8	.85E-02
1200.0	0.0	19.8	.70E-02
1200.0	0.0	30.5	.28E-02
1600.0	0.0	31.1	.56E-02

MAXIMUM VALUE

.47E+00

RUN NUMBER 76
 STABILITY R
 RELEASE HEIGHT (METERS) 0.00
 WIND DIRECTION 270

SAMPLE POSITION (METERS)			CONCENTRATION COEFFICIENT
X	Y	Z	
37.4	28.4	0.0	.94E-01
37.4	14.2	0.0	.23E+00
37.4	0.0	0.0	.54E+00
37.4	-14.2	0.0	.14E+01
37.4	-28.4	0.0	.16E+02
87.0	30.5	0.0	.35E+00
87.0	15.2	0.0	.17E+00
87.0	0.0	0.0	.25E+00
87.0	-15.2	0.0	.46E-01
87.0	-30.5	0.0	.24E+00
187.0	65.0	0.0	.45E-01
187.0	32.5	0.0	.20E-01
187.0	0.0	0.0	.11E+00
187.0	-32.5	0.0	.60E-01
187.0	-65.0	0.0	.16E-01
366.0	64.3	0.0	.37E-01
366.0	32.0	0.0	.73E-01
366.0	0.0	0.0	.13E+00
366.0	-32.0	0.0	.11E+00
366.0	-64.0	0.0	.15E+00
792.0	138.0	0.0	.19E-01
792.0	69.0	0.0	.40E-01
792.0	0.0	0.0	.69E-01
792.0	-69.0	0.0	.51E-01
792.0	-138.0	0.0	.53E-01
1200.0	213.4	0.0	.14E-01
1200.0	106.7	0.0	.19E-01
1200.0	0.0	0.0	.30E-01
1200.0	-106.7	0.0	.18E-01
1200.0	-213.4	0.0	.21E-01
1600.0	224.2	0.0	.46E-02
1600.0	112.1	0.0	.46E-02
1600.0	0.0	0.0	.70E-02
1600.0	-112.1	0.0	.46E-02
1600.0	-224.2	0.0	.46E-02
87.0	0.0	17.8	.81E-02
87.0	0.0	39.4	.11E-01
187.0	0.0	17.8	.76E-01
187.0	0.0	39.4	.27E-01
366.0	0.0	17.8	.49E-01
366.0	0.0	39.4	.49E-01
792.0	0.0	30.5	.27E-01
792.0	0.0	51.8	.33E-01
1200.0	0.0	10.8	.29E-01
1200.0	0.0	30.5	.15E-01
1600.0	0.0	31.1	.19E-01

MAXIMUM VALUE

.16E+02

RUN NUMBER 78
 STABILITY B
 RELEASE HEIGHT (METERS) 22.60
 WIND DIRECTION 270

SAMPLE POSITION (METERS)			CONCENTRATION COEFFICIENT
X	Y	Z	
37.4	28.4	0.0	.58E-01
37.4	14.2	0.0	.14E+01
37.4	0.0	0.0	.19E+01
37.4	-14.2	0.0	.85E+00
37.4	-28.4	0.0	.37E+00
87.0	30.5	0.0	.22E+00
87.0	15.2	0.0	.69E+00
87.0	0.0	0.0	.11E+01
87.0	-15.2	0.0	.92E-01
87.0	-30.5	0.0	.33E+00
187.0	65.0	0.0	.56E-01
187.0	32.5	0.0	.23E-01
187.0	0.0	0.0	.27E+00
187.0	-32.5	0.0	.28E-01
187.0	-65.0	0.0	.12E-01
366.0	64.0	0.0	.82E-01
366.0	32.0	0.0	.14E+00
366.0	0.0	0.0	.22E+00
366.0	-32.0	0.0	.16E+00
366.0	-64.0	0.0	.13E+00
792.0	138.0	0.0	.10E-01
792.0	69.0	0.0	.66E-01
792.0	0.0	0.0	.93E-01
792.0	-69.0	0.0	.51E-01
792.0	-138.0	0.0	.50E-01
1200.0	213.4	0.0	.85E-02
1200.0	106.7	0.0	.99E-02
1200.0	0.0	0.0	.14E-01
1200.0	-106.7	0.0	.62E-02
1200.0	-213.4	0.0	.85E-02
1600.0	224.2	0.0	.28E-02
1600.0	112.1	0.0	.28E-02
1600.0	0.0	0.0	.28E-02
1600.0	-112.1	0.0	.28E-02
1600.0	-224.2	0.0	.28E-02
87.0	0.0	17.8	.28E-02
87.0	0.0	39.4	.14E-01
187.0	0.0	17.8	.11E+00
187.0	0.0	39.4	.17E-01
366.0	0.0	17.8	.62E-01
366.0	0.0	39.4	.60E-01
792.0	0.0	30.5	.32E-01
792.0	0.0	50.8	.23E-01
1200.0	0.0	10.8	.32E-01
1200.0	0.0	30.5	.17E-01
1600.0	0.0	31.1	.23E-01

MAXIMUM VALUE

.19E+01

RUN NUMBER 75
 STABILITY B
 RELEASE HEIGHT (METERS) 29.00
 WIND DIRECTION 270

SAMPLE POSITION (METERS)			CONCENTRATION COEFFICIENT
X	Y	Z	
37.4	28.4	0.0	.16E+00
37.4	14.2	0.0	.49E+00
37.4	0.0	0.0	.70E+00
37.4	-14.2	0.0	.57E+00
37.4	-28.4	0.0	.19E+00
87.0	30.5	0.0	.11E+00
87.0	15.2	0.0	.42E+00
87.0	0.0	0.0	.37E+00
87.0	-15.2	0.0	.21E+00
87.0	-30.5	0.0	.27E+00
187.0	65.0	0.0	.20E-01
187.0	32.5	0.0	.24E-01
187.0	0.0	0.0	.29E+00
187.0	-32.5	0.0	.47E-01
187.0	-65.0	0.0	.20E-01
366.0	64.0	0.0	.61E-01
366.0	32.0	0.0	.12E+00
366.0	0.0	0.0	.21E+00
366.0	-32.0	0.0	.13E+00
366.0	-64.0	0.0	.13E+00
792.0	138.0	0.0	.13E-01
792.0	69.0	0.0	.59E-01
792.0	0.0	0.0	.88E-01
792.0	-69.0	0.0	.49E-01
792.0	-138.0	0.0	.46E-01
1200.0	213.4	0.0	.85E-02
1200.0	106.7	0.0	.85E-02
1200.0	0.0	0.0	.90E-02
1200.0	-106.7	0.0	.11E-01
1200.0	-213.4	0.0	.46E-02
1600.0	224.2	0.0	.28E-02
1600.0	112.1	0.0	.28E-02
1600.0	0.0	0.0	.28E-02
1600.0	-112.1	0.0	.28E-02
1600.0	-224.2	0.0	.28E-02
87.0	0.0	17.8	.82E-02
87.0	0.0	39.4	.82E-02
187.0	0.0	17.8	.33E-01
187.0	0.0	39.4	.28E-01
366.0	0.0	17.8	.68E-01
366.0	0.0	39.4	.28E-01
792.0	0.0	30.5	.19E-01
792.0	0.0	50.8	.20E-01
1200.0	0.0	10.8	.17E-01
1200.0	0.0	30.5	.22E-01
1600.0	0.0	31.1	.17E-01

MAXIMUM VALUE

.70E+00

RUN NUMBER 8G
 STABILITY E
 RELEASE HEIGHT (METERS) 0.00
 WIND DIRECTION 315

SAMPLE POSITION (METERS)			CONCENTRATION COEFFICIENT
X	Y	Z	
37.4	28.4	0.0	.94E-01
37.4	14.2	0.0	.14E+00
37.4	0.0	0.0	.45E+00
37.4	-14.2	0.0	.12E+01
37.4	-28.4	0.0	.19E+01
87.0	30.5	0.0	.93E-01
87.0	15.2	0.0	.19E+00
87.0	0.0	0.0	.41E+00
87.0	-15.2	0.0	.19E-01
87.0	-30.5	0.0	.23E+00
187.0	65.0	0.0	.13E-01
187.0	32.5	0.0	.12E-01
187.0	0.0	0.0	.21E+00
187.0	-32.5	0.0	.20E-01
187.0	-65.0	0.0	.21E-01
366.0	64.0	0.0	.46E-01
366.0	32.0	0.0	.82E-01
366.0	0.0	0.0	.17E+00
366.0	-32.0	0.0	.11E+00
366.0	-64.0	0.0	.96E-01
792.0	138.0	0.0	.13E-01
792.0	69.0	0.0	.45E-01
792.0	0.0	0.0	.77E-01
792.0	-69.0	0.0	.38E-01
792.0	-138.0	0.0	.35E-01
1200.0	213.4	0.0	.79E-02
1200.0	106.7	0.0	.70E-02
1200.0	0.0	0.0	.56E-02
1200.0	-106.7	0.0	.74E-02
1200.0	-213.4	0.0	.70E-02
1600.0	224.2	0.0	.23E-02
1600.0	112.1	0.0	.23E-02
1600.0	0.0	0.0	.23E-02
1600.0	-112.1	0.0	.23E-02
1600.0	-224.2	0.0	.23E-02
87.0	0.0	17.8	.95E-02
87.0	0.0	39.4	.65E-02
187.0	0.0	17.8	.25E-01
187.0	0.0	39.4	.30E-01
366.0	0.0	17.8	.40E-02
366.0	0.0	39.4	.29E-01
792.0	0.0	30.5	.19E-01
792.0	0.0	50.8	.28E-01
1200.0	0.0	10.8	.25E-01
1200.0	0.0	30.5	.17E-01
1600.0	0.0	31.1	.19E-01

MAXIMUM VALUE

.19E+01

RUN NUMBER 08
 STABILITY B
 RELEASE HEIGHT (METERS) 22.60
 WIND DIRECTION 315

SAMPLE POSITION (METERS)			CONCENTRATION COEFFICIENT
X	Y	Z	
37.4	28.4	0.0	.16E+00
37.4	14.2	0.0	.39E+00
37.4	0.0	0.0	.54E+00
37.4	-14.2	0.0	.18E+00
37.4	-28.4	0.0	.94E-01
87.0	30.5	0.0	.24E+00
87.0	15.2	0.0	.44E+00
87.0	0.0	0.0	.48E+00
87.0	-15.2	0.0	.21E+00
87.0	-30.5	0.0	.97E-01
187.0	65.0	0.0	.76E-02
187.0	32.5	0.0	.12E-01
187.0	0.0	0.0	.24E+00
187.0	-32.5	0.0	.45E-01
187.0	-65.0	0.0	.28E-01
366.0	64.0	0.0	.92E-01
366.0	32.0	0.0	.13E+00
366.0	0.0	0.0	.17E+00
366.0	-32.0	0.0	.81E-01
366.0	-64.0	0.0	.43E-01
792.0	138.0	0.0	.87E-02
792.0	69.0	0.0	.75E-01
792.0	0.0	0.0	.81E-01
792.0	-69.0	0.0	.31E-01
792.0	-138.0	0.0	.29E-01
1200.0	213.4	0.0	.17E-01
1200.0	106.7	0.0	.56E-02
1200.0	0.0	0.0	.59E-02
1200.0	-106.7	0.0	.59E-02
1200.0	-213.4	0.0	.51E-02
1600.0	224.2	0.0	.28E-02
1600.0	112.1	0.0	.28E-02
1600.0	0.0	0.0	.28E-02
1600.0	-112.1	0.0	.28E-02
1600.0	-224.2	0.0	.28E-02
87.0	0.0	17.9	.65E-02
87.0	0.0	39.4	.42E-02
187.0	0.0	17.8	.34E-01
187.0	0.0	39.4	.29E-01
366.0	0.0	17.8	.39E-02
366.0	0.0	39.4	.28E-01
792.0	0.0	30.5	.18E-01
792.0	0.0	50.8	.27E-01
1200.0	0.0	10.8	.26E-01
1200.0	0.0	30.5	.16E-01
1600.0	0.0	31.1	.20E-01

MAXIMUM VALUE

.54E+00

RUN NUMBER 85
 STABILITY B
 RELEASE HEIGHT (METERS) 29.00
 WIND DIRECTION 315

SAMPLE POSITION (METERS)			CONCENTRATION COEFFICIENT
X	Y	Z	
37.4	28.4	0.0	.58E-01
37.4	14.2	0.0	.17E+00
37.4	0.0	0.0	.39E+00
37.4	-14.2	0.0	.17E+00
37.4	-28.4	0.0	.79E-01
87.0	30.5	0.0	.14E+00
87.0	15.2	0.0	.37E+00
87.0	0.0	0.0	.47E+00
87.0	-15.2	0.0	.12E+00
87.0	-30.5	0.0	.70E-01
187.0	65.0	0.0	.70E-02
187.0	32.5	0.0	.99E-02
187.0	0.0	0.0	.13E+00
187.0	-32.5	0.0	.46E-01
187.0	-65.0	0.0	.12E-01
366.0	64.0	0.0	.90E-01
366.0	32.0	0.0	.63E-01
366.0	0.0	0.0	.19E+00
366.0	-32.0	0.0	.82E-01
366.0	-64.0	0.0	.35E-01
792.0	138.0	0.0	.54E-02
792.0	69.0	0.0	.62E-01
792.0	0.0	0.0	.81E-01
792.0	-69.0	0.0	.24E-01
792.0	-138.0	0.0	.22E-01
1200.0	213.4	0.0	.12E-01
1200.0	106.7	0.0	.11E-01
1200.0	0.0	0.0	.85E-02
1200.0	-106.7	0.0	.31E-02
1200.0	-213.4	0.0	.28E-02
1600.0	224.2	0.0	.28E-02
1600.0	112.1	0.0	.28E-02
1600.0	0.0	0.0	.28E-02
1600.0	-112.1	0.0	.28E-02
1600.0	-224.2	0.0	.28E-02
87.0	0.0	17.8	.65E-02
87.0	0.0	39.4	.42E-02
187.0	0.0	17.8	.34E-01
187.0	0.0	39.4	.31E-01
366.0	0.0	17.8	.42E-02
366.0	0.0	39.4	.28E-01
792.0	0.0	30.5	.18E-01
792.0	0.0	50.8	.28E-01
1200.0	0.0	10.8	.28E-01
1200.0	0.0	30.5	.17E-01
1600.0	0.0	31.1	.20E-01

MAXIMUM VALUE

.47E+00

RUN NUMBER 96
 STABILITY B
 RELEASE HEIGHT (METERS) 0.00
 WIND DIRECTION 0

SAMPLE POSITION (METERS)			CONCENTRATION COEFFICIENT
X	Y	Z	
37.4	28.4	0.0	.16E+01
37.4	14.2	0.0	.48E+01
37.4	0.0	0.0	.16E+01
37.4	-14.2	0.0	.79E+00
37.4	-28.4	0.0	.26E+00
87.0	30.5	0.0	.15E+01
87.0	15.2	0.0	.19E+01
87.0	0.0	0.0	.40E+01
87.0	-15.2	0.0	.73E+00
87.0	-30.5	0.0	.36E-01
187.0	65.0	0.0	.56E-01
187.0	32.5	0.0	.31E+00
187.0	0.0	0.0	.13E+01
187.0	-32.5	0.0	.61E-01
187.0	-65.0	0.0	.85E-02
366.0	64.0	0.0	.29E-01
366.0	32.0	0.0	.44E-01
366.0	0.0	0.0	.23E+00
366.0	-32.0	0.0	.12E+00
366.0	-64.0	0.0	.85E-01
792.0	138.0	0.0	.61E-02
792.0	69.0	0.0	.65E-01
792.0	0.0	0.0	.83E-01
792.0	-69.0	0.0	.14E-01
792.0	-138.0	0.0	.26E-02
1200.0	213.4	0.0	.11E-01
1200.0	106.7	0.0	.11E-02
1200.0	0.0	0.0	.79E-03
1200.0	-106.7	0.0	.19E-02
1200.0	-213.4	0.0	.29E-02
1600.0	224.2	0.0	.79E-03
1600.0	112.1	0.0	.79E-03
1600.0	0.0	0.0	.79E-03
1600.0	-112.1	0.0	.79E-03
1600.0	-224.2	0.0	.79E-03
87.0	0.0	17.8	.56E-02
87.0	0.0	39.4	.16E-02
187.0	0.0	17.8	.23E+00
187.0	0.0	39.4	.10E-01
366.0	0.0	17.8	.25E-01
366.0	0.0	39.4	.26E-01
792.0	0.0	30.5	.19E-01
792.0	0.0	50.8	.15E-01
1200.0	0.0	10.8	.37E-01
1200.0	0.0	30.5	.79E-02
1600.0	0.0	31.1	.29E-01

MAXIMUM VALUE

.48E+01

RUN NUMBER 98
 STABILITY B
 RELEASE HEIGHT (METERS) 22.60
 WIND DIRECTION 0

SAMPLE POSITION (METERS)			CONCENTRATION COEFFICIENT
X	Y	Z	
37.4	28.4	0.0	.64E-02
37.4	14.2	0.0	.64E-02
37.4	0.0	0.0	.64E-02
37.4	-14.2	0.0	.64E-02
37.4	-28.4	0.0	.64E-02
87.0	30.5	0.0	.51E-02
87.0	15.2	0.0	.61E-02
87.0	0.0	0.0	.54E-02
87.0	-15.2	0.0	.16E-02
87.0	-30.5	0.0	.26E-02
187.0	65.0	0.0	.16E-02
187.0	32.5	0.0	.22E-02
187.0	0.0	0.0	.13E-01
187.0	-32.5	0.0	.13E-02
187.0	-65.0	0.0	.29E-02
366.0	64.0	0.0	.90E-02
366.0	32.0	0.0	.25E-01
366.0	0.0	0.0	.52E-01
366.0	-32.0	0.0	.18E-01
366.0	-64.0	0.0	.64E-02
792.0	138.0	0.0	.16E-02
792.0	69.0	0.0	.39E-01
792.0	0.0	0.0	.50E-01
792.0	-69.0	0.0	.61E-02
792.0	-138.0	0.0	.22E-02
1200.0	213.4	0.0	.96E-03
1200.0	106.7	0.0	.96E-03
1200.0	0.0	0.0	.35E-02
1200.0	-106.7	0.0	.29E-02
1200.0	-213.4	0.0	.32E-02
1600.0	224.2	0.0	0.
1600.0	112.1	0.0	0.
1600.0	0.0	0.0	0.
1600.0	-112.1	0.0	0.
1600.0	-224.2	0.0	0.
87.0	0.0	17.8	.22E-02
87.0	0.0	39.4	.14E+00
187.0	0.0	17.8	.17E+00
187.0	0.0	39.4	.16E+00
366.0	0.0	17.8	.16E+00
366.0	0.0	39.4	.65E-01
792.0	0.0	30.5	.19E-01
792.0	0.0	50.8	.22E-01
1200.0	0.0	10.8	.23E-01
1200.0	0.0	30.5	.51E-02
1600.0	0.0	31.1	.22E-01

MAXIMUM VALUE

.17E+00

RUN NUMBER 95
 STABILITY B
 RELEASE HEIGHT (METERS) 29.00
 WIND DIRECTION 0

SAMPLE POSITION (METERS)			CONCENTRATION COEFFICIENT
X	Y	Z	
37.4	28.4	0.0	.32E-01
37.4	14.2	0.0	.32E-01
37.4	0.0	0.0	.64E-01
37.4	-14.2	0.0	.32E-01
37.4	-28.4	0.0	.32E-01
87.0	30.5	0.0	.27E-01
87.0	15.2	0.0	.30E-01
87.0	0.0	0.0	.51E-01
87.0	-15.2	0.0	.29E-01
87.0	-30.5	0.0	.58E-02
187.0	65.0	0.0	.29E-02
187.0	32.5	0.0	.11E-01
187.0	0.0	0.0	.43E-01
187.0	-32.5	0.0	.55E-02
187.0	-65.0	0.0	.58E-02
366.0	64.0	0.0	.18E-01
366.0	32.0	0.0	.49E-01
366.0	0.0	0.0	.82E-01
366.0	-32.0	0.0	.35E-01
366.0	-64.0	0.0	.13E-01
792.0	138.0	0.0	.35E-02
792.0	69.0	0.0	.58E-01
792.0	0.0	0.0	.72E-01
792.0	-69.0	0.0	.11E-01
792.0	-138.0	0.0	.20E-01
1200.0	213.4	0.0	.22E-02
1200.0	106.7	0.0	.19E-02
1200.0	0.0	0.0	.48E-02
1200.0	-106.7	0.0	.45E-02
1200.0	-213.4	0.0	.61E-02
1600.0	224.2	0.0	0.
1600.0	112.1	0.0	0.
1600.0	0.0	0.0	0.
1600.0	-112.1	0.0	0.
1600.0	-224.2	0.0	0.
87.0	0.0	17.8	.42E-02
87.0	0.0	34.4	.17E+00
187.0	0.0	17.8	.20E+00
187.0	0.0	34.4	.20E+00
366.0	0.0	17.8	.14E+00
366.0	0.0	34.4	.90E-01
792.0	0.0	30.5	.32E-01
792.0	0.0	50.8	.33E-01
1200.0	0.0	10.8	.34E-01
1200.0	0.0	30.5	.64E-02
1600.0	0.0	31.1	.26E-01

MAXIMUM VALUE

.20E+00

TABLE IV. Data, Neutral

RUN NUMBER 16
 STABILITY C
 RELEASE HEIGHT (METERS) 0.00
 WIND DIRECTION 0

SAMPLE POSITION (METERS)			CONCENTRATION COEFFICIENT
X	Y	Z	
37.4	28.4	0.0	.36E+01
37.4	14.2	0.0	.18E+01
37.4	0.0	0.0	.43E+00
37.4	-14.2	0.0	.77E-01
37.4	-28.4	0.0	.18E-01
87.0	30.5	0.0	.60E+00
87.0	15.2	0.0	.34E+00
87.0	0.0	0.0	.62E-01
87.0	-15.2	0.0	.24E-01
87.0	-30.5	0.0	.81E-02
187.0	65.0	0.0	.68E-01
187.0	32.5	0.0	.31E+00
187.0	0.0	0.0	.70E-01
187.0	-32.5	0.0	.16E-01
187.0	-65.0	0.0	.39E-02
366.0	64.0	0.0	.10E+00
366.0	32.0	0.0	.15E+00
366.0	0.0	0.0	.67E-01
366.0	-32.0	0.0	.30E-01
366.0	-64.0	0.0	.95E-02
792.0	138.0	0.0	.33E-02
792.0	69.0	0.0	.44E-01
792.0	0.0	0.0	.53E-01
792.0	-69.0	0.0	.10E-01
792.0	-138.0	0.0	.21E-02
1200.0	213.4	0.0	.18E-02
1200.0	106.7	0.0	.30E-01
1200.0	0.0	0.0	.27E-01
1200.0	-106.7	0.0	.17E-01
1200.0	-213.4	0.0	.69E-02
1600.0	224.2	0.0	.30E-02
1600.0	112.1	0.0	.84E-02
1600.0	0.0	0.0	.95E-02
1600.0	-112.1	0.0	.90E-02
1600.0	-224.2	0.0	.12E-02
87.0	0.0	17.8	.79E-01
87.0	0.0	39.4	.72E-02
187.0	0.0	17.8	.62E-01
187.0	0.0	39.4	.15E-01
366.0	0.0	17.8	.17E-01
366.0	0.0	39.4	.10E-01
792.0	0.0	30.5	.25E-01
792.0	0.0	50.8	.11E-01
1200.0	0.0	10.8	.12E-01
1200.0	0.0	30.5	.72E-02
1600.0	0.0	31.1	.16E-01

MAXIMUM VALUE

.36E+01

RUN NUMBER 18
 STABILITY 0
 RELEASE HEIGHT (METERS) 22.60
 WIND DIRECTION 0

SAMPLE POSITION (METERS)			CONCENTRATION COEFFICIENT
X	Y	Z	
37.4	28.4	0.0	.12E-01
37.4	14.2	0.0	.20E+00
37.4	0.0	0.0	.69E+00
37.4	-14.2	0.0	.71E+00
37.4	-28.4	0.0	.12E+00
87.0	30.5	0.0	.22E-01
87.0	15.2	0.0	.22E+00
87.0	0.0	0.0	.64E+00
87.0	-15.2	0.0	.20E+00
87.0	-30.5	0.0	.43E-01
187.0	65.0	0.0	.10E-01
187.0	32.5	0.0	.21E+00
187.0	0.0	0.0	.28E+00
187.0	-32.5	0.0	.87E-01
187.0	-65.0	0.0	.72E-02
366.0	64.0	0.0	.42E-01
366.0	32.0	0.0	.16E+00
366.0	0.0	0.0	.15E+00
366.0	-32.0	0.0	.12E+00
366.0	-64.0	0.0	.47E-01
792.0	138.0	0.0	.51E-02
792.0	69.0	0.0	.33E-01
792.0	0.0	0.0	.58E-01
792.0	-69.0	0.0	.26E-01
792.0	-138.0	0.0	.43E-02
1200.0	213.4	0.0	.22E-02
1200.0	106.7	0.0	.25E-01
1200.0	0.0	0.0	.35E-01
1200.0	-106.7	0.0	.32E-01
1200.0	-213.4	0.0	.12E-01
1600.0	224.2	0.0	.40E-02
1600.0	112.1	0.0	.72E-02
1600.0	0.0	0.0	.17E-01
1600.0	-112.1	0.0	.16E-01
1600.0	-224.2	0.0	.43E-02
87.0	0.0	17.8	.43E+00
87.0	0.0	39.4	.20E-01
187.0	0.0	17.8	.16E+00
187.0	0.0	39.4	.23E-01
366.0	0.0	17.8	.26E-01
366.0	0.0	39.4	.18E-01
792.0	0.0	30.5	.27E-01
792.0	0.0	50.9	.11E-01
1200.0	0.0	10.8	.12E-01
1200.0	0.0	30.5	.83E-02
1600.0	0.0	31.1	.18E-01

MAXIMUM VALUE

.71E+00

RUN NUMBER 15
 STABILITY C
 RELEASE HEIGHT (METERS) 29.00
 WIND DIRECTION 0

SAMPLE POSITION (METERS)			CONCENTRATION COEFFICIENT
X	Y	Z	
37.4	28.4	0.0	.61E-02
37.4	14.2	0.0	.42E-01
37.4	0.0	0.0	.78E-01
37.4	-14.2	0.0	.72E-01
37.4	-28.4	0.0	.13E-01
87.0	30.5	0.0	.16E-01
87.0	15.2	0.0	.14E+00
87.0	0.0	0.0	.21E+00
87.0	-15.2	0.0	.50E-01
87.0	-30.5	0.0	.11E-01
187.0	65.0	0.0	.34E-02
187.0	32.5	0.0	.97E-01
187.0	0.0	0.0	.25E+00
187.0	-32.5	0.0	.84E-01
187.0	-65.0	0.0	.34E-02
366.0	64.0	0.0	.20E-01
366.0	32.0	0.0	.11E+00
366.0	0.0	0.0	.16E+00
366.0	-32.0	0.0	.13E+00
366.0	-64.0	0.0	.44E-01
792.0	138.0	0.0	.19E-02
792.0	69.0	0.0	.22E-01
792.0	0.0	0.0	.68E-01
792.0	-69.0	0.0	.39E-01
792.0	-138.0	0.0	.36E-02
1200.0	213.4	0.0	.19E-02
1200.0	106.7	0.0	.18E-01
1200.0	0.0	0.0	.34E-01
1200.0	-106.7	0.0	.33E-01
1200.0	-213.4	0.0	.69E-02
1600.0	224.2	0.0	.72E-02
1600.0	112.1	0.0	.86E-02
1600.0	0.0	0.0	.21E-01
1600.0	-112.1	0.0	.20E-01
1600.0	-224.2	0.0	.13E-02
87.0	0.0	17.8	.17E+00
87.0	0.0	39.4	.13E+00
187.0	0.0	17.8	.20E+00
187.0	0.0	39.4	.27E-01
366.0	0.0	17.8	.34E-01
366.0	0.0	39.4	.29E-01
792.0	0.0	30.5	.23E-01
792.0	0.0	50.8	.90E-02
1200.0	0.0	10.8	.21E-01
1200.0	0.0	30.5	.44E-02
1600.0	0.0	31.1	.12E-01

MAXIMUM VALUE

.25E+00

RUN NUMBER 26
 STABILITY C
 RELEASE HEIGHT (METERS) 0.08
 WIND DIRECTION 45

SAMPLE POSITION (METERS)			CONCENTRATION COEFFICIENT
X	Y	Z	
37.4	28.4	0.0	.10E+00
37.4	14.2	0.0	.14E+01
37.4	0.0	0.0	.84E+00
37.4	-14.2	0.0	.10E+00
37.4	-28.4	0.0	.60E-02
87.0	30.5	0.0	.83E-01
87.0	15.2	0.0	.53E+00
87.0	0.0	0.0	.42E+00
87.0	-15.2	0.0	.93E-01
87.0	-30.5	0.0	.30E-02
187.0	65.0	0.0	.90E-03
187.0	32.5	0.0	.13E+00
187.0	0.0	0.0	.22E+00
187.0	-32.5	0.0	.26E-01
187.0	-65.0	0.0	0.
366.0	64.0	0.0	.16E-01
366.0	32.0	0.0	.10E+00
366.0	0.0	0.0	.15E+00
366.0	-32.0	0.0	.64E-01
366.0	-64.0	0.0	.84E-02
792.0	138.0	0.0	0.
792.0	69.0	0.0	.18E-01
792.0	0.0	0.0	.69E-01
792.0	-69.0	0.0	.13E-01
792.0	-138.0	0.0	0.
1200.0	213.4	0.0	0.
1200.0	106.7	0.0	.14E-01
1200.0	0.0	0.0	.26E-01
1200.0	-106.7	0.0	.24E-01
1200.0	-213.4	0.0	0.
1600.0	224.2	0.0	0.
1600.0	112.1	0.0	.90E-03
1600.0	0.0	0.0	.12E-01
1600.0	-112.1	0.0	.11E-01
1600.0	-224.2	0.0	0.
87.0	0.0	17.8	.27E+00
87.0	0.0	39.4	.38E-01
187.0	0.0	17.8	.19E+00
187.0	0.0	39.4	.45E-01
366.0	0.0	17.8	.38E-01
366.0	0.0	39.4	.13E-01
792.0	0.0	30.5	.30E-01
792.0	0.0	50.8	.93E-02
1200.0	0.0	10.8	.20E-01
1200.0	0.0	30.5	.60E-02
1600.0	0.0	31.1	.11E-01

MAXIMUM VALUE

.14E+01

RUN NUMBER 28
 STABILITY C
 RELEASE HEIGHT (METERS) 22.60
 WIND DIRECTION 45

SAMPLE POSITION (METERS)			CONCENTRATION COEFFICIENT
X	Y	Z	
37.4	28.4	0.0	0.
37.4	14.2	0.0	.12E-01
37.4	0.0	0.0	.13E+00
37.4	-14.2	0.0	.31E-01
37.4	-28.4	0.0	.11E-02
87.0	30.5	0.0	.94E-02
87.0	15.2	0.0	.77E-01
87.0	0.0	0.0	.12E+00
87.0	-15.2	0.0	.47E-01
87.0	-30.5	0.0	0.
187.0	65.0	0.0	0.
187.0	32.5	0.0	.31E-01
187.0	0.0	0.0	.14E+00
187.0	-32.5	0.0	.22E-01
187.0	-65.0	0.0	0.
366.0	64.0	0.0	.33E-02
366.0	32.0	0.0	.54E-01
366.0	0.0	0.0	.12E+00
366.0	-32.0	0.0	.77E-01
366.0	-64.0	0.0	.12E-01
792.0	138.0	0.0	0.
792.0	69.0	0.0	.10E-01
792.0	0.0	0.0	.59E-01
792.0	-69.0	0.0	.17E-01
792.0	-138.0	0.0	0.
1200.0	213.4	0.0	0.
1200.0	106.7	0.0	.98E-02
1200.0	0.0	0.0	.21E-01
1200.0	-106.7	0.0	.25E-01
1200.0	-213.4	0.0	0.
1600.0	224.2	0.0	0.
1600.0	112.1	0.0	.36E-03
1600.0	0.0	0.0	.13E-01
1600.0	-112.1	0.0	.12E-01
1600.0	-224.2	0.0	0.
87.0	0.0	17.8	.13E+00
87.0	0.0	39.4	.76E-01
187.0	0.0	17.8	.18E+00
187.0	0.0	39.4	.78E-01
366.0	0.0	17.8	.38E-01
366.0	0.0	39.4	.28E-01
792.0	0.0	30.5	.27E-01
792.0	0.0	50.8	.98E-02
1200.0	0.0	10.8	.19E-01
1200.0	0.0	30.5	.58E-02
1600.0	0.0	31.1	.10E-01

MAXIMUM VALUE

.18E+00

RUN NUMBER 25
 STABILITY C
 RELEASE HEIGHT (METERS) 29.00
 WIND DIRECTION 45

SAMPLE POSITION (METERS)			CONCENTRATION COEFFICIENT
X	Y	Z	
37.4	28.4	0.0	.33E-02
37.4	14.2	0.0	.51E-02
37.4	0.0	0.0	.27E-01
37.4	-14.2	0.0	.54E-02
37.4	-28.4	0.0	.36E-02
87.0	30.5	0.0	.37E-01
87.0	15.2	0.0	.51E-01
87.0	0.0	0.0	.53E-01
87.0	-15.2	0.0	.21E-01
87.0	-30.5	0.0	.25E-02
187.0	65.0	0.0	.25E-02
187.0	32.5	0.0	.21E-01
187.0	0.0	0.0	.10E+00
187.0	-32.5	0.0	.24E-01
187.0	-65.0	0.0	.40E-02
366.0	64.0	0.0	.65E-02
366.0	32.0	0.0	.43E-01
366.0	0.0	0.0	.12E+00
366.0	-32.0	0.0	.81E-01
366.0	-64.0	0.0	.13E-01
792.0	138.0	0.0	.18E-02
792.0	69.0	0.0	.94E-02
792.0	0.0	0.0	.69E-01
792.0	-69.0	0.0	.20E-01
792.0	-138.0	0.0	.13E-01
1200.0	213.4	0.0	.18E-02
1200.0	106.7	0.0	.12E-01
1200.0	0.0	0.0	.33E-01
1200.0	-106.7	0.0	.34E-01
1200.0	-213.4	0.0	.61E-02
1600.0	224.2	0.0	.33E-02
1600.0	112.1	0.0	.51E-02
1600.0	0.0	0.0	.20E-01
1600.0	-112.1	0.0	.18E-01
1600.0	-224.2	0.0	0.
87.0	0.0	17.8	.25E+00
87.0	0.0	39.4	.18E+00
187.0	0.0	17.8	.19E+00
187.0	0.0	39.4	.11E+00
366.0	0.0	17.8	.83E-01
366.0	0.0	39.4	.71E-01
792.0	0.0	30.5	.46E-01
792.0	0.0	50.8	.21E-01
1200.0	0.0	10.8	.27E-01
1200.0	0.0	30.5	.47E-02
1600.0	0.0	31.1	.14E-01

MAXIMUM VALUE

.25E+00

RUN NUMBER 30
 STABILITY 0
 RELEASE HEIGHT (METERS) 0.00
 WIND DIRECTION 90

SAMPLE POSITION (METERS)			CONCENTRATION COEFFICIENT
X	Y	Z	
37.4	28.4	0.0	.48E+00
37.4	14.2	0.0	.67E+00
37.4	0.0	0.0	.44E+00
37.4	-14.2	0.0	.39E+00
37.4	-28.4	0.0	.30E+00
87.0	30.5	0.0	.78E-01
87.0	15.2	0.0	.24E+00
87.0	0.0	0.0	.35E+00
87.0	-15.2	0.0	.12E+00
87.0	-30.5	0.0	.12E+00
187.0	65.0	0.0	.69E-02
187.0	32.5	0.0	.11E+00
187.0	0.0	0.0	.23E+00
187.0	-32.5	0.0	.68E-01
187.0	-65.0	0.0	.30E-02
366.0	64.0	0.0	.24E-01
366.0	32.0	0.0	.98E-01
366.0	0.0	0.0	.11E+00
366.0	-32.0	0.0	.13E+00
366.0	-64.0	0.0	.35E-01
792.0	138.0	0.0	0.
792.0	69.0	0.0	.18E-01
792.0	0.0	0.0	.67E-01
792.0	-69.0	0.0	.69E-02
792.0	-138.0	0.0	.35E-01
1200.0	213.4	0.0	0.
1200.0	106.7	0.0	0.
1200.0	0.0	0.0	.30E-01
1200.0	-106.7	0.0	.36E-01
1200.0	-213.4	0.0	.33E-02
1600.0	224.2	0.0	0.
1600.0	112.1	0.0	.27E-02
1600.0	0.0	0.0	.19E-01
1600.0	-112.1	0.0	.19E-01
1600.0	-224.2	0.0	0.
87.0	0.0	17.8	.30E-01
87.0	0.0	39.4	.34E-01
187.0	0.0	17.8	.47E-01
187.0	0.0	39.4	.18E+00
366.0	0.0	17.8	.36E-01
366.0	0.0	39.4	.28E-01
792.0	0.0	30.5	.25E-01
792.0	0.0	50.8	.12E-01
1200.0	0.0	10.8	.22E-01
1200.0	0.0	30.5	.21E-01
1600.0	0.0	31.1	.42E-02

MAXIMUM VALUE

.67E+00

RUN NUMBER 38
 STABILITY C
 RELEASE HEIGHT (METERS) 22.60
 WIND DIRECTION 90

SAMPLE POSITION (METERS)			CONCENTRATION COEFFICIENT
X	Y	Z	
37.4	20.4	0.0	.45E-01
37.4	14.2	0.0	.13E+00
37.4	0.0	0.0	.32E+00
37.4	-14.2	0.0	.43E-01
37.4	-20.4	0.0	.41E-01
87.0	30.5	0.0	.20E-01
87.0	15.2	0.0	.16E+00
87.0	0.0	0.0	.38E+00
87.0	-15.2	0.0	.14E+00
87.0	-30.5	0.0	.44E-01
187.0	65.0	0.0	.36E-02
187.0	32.5	0.0	.69E-01
187.0	0.0	0.0	.24E+00
187.0	-32.5	0.0	.23E+00
187.0	-65.0	0.0	.25E-02
366.0	64.0	0.0	.11E-01
366.0	32.0	0.0	.68E-01
366.0	0.0	0.0	.11E+00
366.0	-32.0	0.0	.14E+00
366.0	-64.0	0.0	.36E-01
792.0	138.0	0.0	.36E-03
792.0	69.0	0.0	.98E-02
792.0	0.0	0.0	.60E-01
792.0	-69.0	0.0	.13E-01
792.0	-138.0	0.0	.43E-01
1200.0	213.4	0.0	.72E-03
1200.0	106.7	0.0	0.
1200.0	0.0	0.0	.28E-01
1200.0	-106.7	0.0	.34E-01
1200.0	-213.4	0.0	.54E-02
1600.0	224.2	0.0	.58E-02
1600.0	112.1	0.0	.33E-02
1600.0	0.0	0.0	.22E-01
1600.0	-112.1	0.0	.21E-01
1600.0	-224.2	0.0	0.
87.0	0.0	17.8	.11E+00
87.0	0.0	39.4	.71E-01
187.0	0.0	17.8	.24E+00
187.0	0.0	39.4	.39E-01
366.0	0.0	17.8	.94E-02
366.0	0.0	39.4	.36E-02
792.0	0.0	30.5	.15E-01
792.0	0.0	50.8	.14E-02
1200.0	0.0	10.8	.14E-01
1200.0	0.0	30.5	0.
1600.0	0.0	31.1	.54E-02

MAXIMUM VALUE

.38E+00

RUN NUMBER 3S
 STABILITY 0
 RELEASE HEIGHT (METERS) 29.00
 WIND DIRECTION 90

SAMPLE POSITION (METERS)			CONCENTRATION COEFFICIENT
X	Y	Z	
37.4	28.4	0.0	.29E-02
37.4	14.2	0.0	.12E-01
37.4	0.0	0.0	.75E-01
37.4	-14.2	0.0	.65E-01
37.4	-28.4	0.0	.60E-01
87.0	30.5	0.0	.36E-02
87.0	15.2	0.0	.62E-01
87.0	0.0	0.0	.19E+00
87.0	-15.2	0.0	.76E-01
87.0	-30.5	0.0	.74E-01
187.0	65.0	0.0	.11E-02
187.0	32.5	0.0	.47E-01
187.0	0.0	0.0	.24E+00
187.0	-32.5	0.0	.88E-01
187.0	-65.0	0.0	.36E-02
366.0	64.0	0.0	.10E-01
366.0	32.0	0.0	.67E-01
366.0	0.0	0.0	.14E+00
366.0	-32.0	0.0	.16E+00
366.0	-64.0	0.0	.43E-01
792.0	138.0	0.0	.11E-02
792.0	69.0	0.0	.14E-01
792.0	0.0	0.0	.62E-01
792.0	-69.0	0.0	.22E-01
792.0	-138.0	0.0	.41E-01
1200.0	213.4	0.0	.72E-03
1200.0	106.7	0.0	0.
1200.0	0.0	0.0	.29E-01
1200.0	-106.7	0.0	.38E-01
1200.0	-213.4	0.0	.58E-02
1600.0	224.2	0.0	.18E-02
1600.0	112.1	0.0	.36E-02
1600.0	0.0	0.0	.24E-01
1600.0	-112.1	0.0	.21E-01
1600.0	-224.2	0.0	0.
87.0	0.0	17.8	.71E-01
87.0	0.0	39.4	.14E+00
187.0	0.0	17.8	.10E+00
187.0	0.0	39.4	.22E+00
366.0	0.0	17.8	.46E-01
366.0	0.0	39.4	.71E-01
792.0	0.0	30.5	.28E-01
792.0	0.0	50.8	.16E-01
1200.0	0.0	10.8	.23E-01
1200.0	0.0	30.5	.23E-01
1600.0	0.0	31.1	.51E-02

MAXIMUM VALUE

.24E+00

RUN NUMBER 46
 STABILITY C
 RELEASE HEIGHT (METERS) 0.00
 WIND DIRECTION 135

SAMPLE POSITION (METERS)			CONCENTRATION COEFFICIENT
X	Y	Z	
37.4	28.4	0.0	.29E+00
37.4	14.2	0.0	.12E+01
37.4	0.0	0.0	.16E+01
37.4	-14.2	0.0	.13E+01
37.4	-28.4	0.0	.36E-02
87.0	30.5	0.0	.80E-02
87.0	15.2	0.0	.25E+00
87.0	0.0	0.0	.73E+00
87.0	-15.2	0.0	.85E+00
87.0	-30.5	0.0	.56E+01
187.0	65.0	0.0	0.
187.0	32.5	0.0	.41E-01
187.0	0.0	0.0	.43E+01
187.0	-32.5	0.0	.26E+00
187.0	-65.0	0.0	.13E-01
366.0	64.0	0.0	.58E-02
366.0	32.0	0.0	.84E-01
366.0	0.0	0.0	.30E+00
366.0	-32.0	0.0	.30E+00
366.0	-64.0	0.0	.73E-01
792.0	138.0	0.0	0.
792.0	69.0	0.0	.13E-01
792.0	0.0	0.0	.13E+00
792.0	-69.0	0.0	.41E-01
792.0	-138.0	0.0	.58E-01
1200.0	213.4	0.0	0.
1200.0	106.7	0.0	.12E-01
1200.0	0.0	0.0	.23E-01
1200.0	-106.7	0.0	0.
1200.0	-213.4	0.0	.87E-02
1600.0	224.2	0.0	.87E-02
1600.0	112.1	0.0	.58E-02
1600.0	0.0	0.0	.32E-01
1600.0	-112.1	0.0	.31E-01
1600.0	-224.2	0.0	0.
87.0	0.0	17.8	.59E-01
87.0	0.0	39.4	.51E-01
187.0	0.0	17.8	.36E+00
187.0	0.0	39.4	.10E+00
366.0	0.0	17.8	.68E-01
366.0	0.0	39.4	.39E-01
792.0	0.0	30.5	.31E-01
792.0	0.0	50.8	.73E-03
1200.0	0.0	10.8	.36E-01
1200.0	0.0	31.5	0.
1600.0	0.0	31.1	.58E-02

MAXIMUM VALUE

.16E+01

RUN NUMBER 48
 STABILITY 0
 RELEASE HEIGHT (METERS) 22.60
 WIND DIRECTION 135

SAMPLE POSITION (METERS)			CONCENTRATION COEFFICIENT
X	Y	Z	
37.4	24.0	0.0	.14E+00
37.4	14.2	0.0	.41E+00
37.4	0.0	0.0	.45E+00
37.4	-14.2	0.0	.21E+00
37.4	-24.0	0.0	0.
87.0	35.5	0.0	.35E-02
87.0	15.2	0.0	.16E+00
87.0	0.0	0.0	.61E+00
87.0	-15.2	0.0	.65E+00
87.0	-30.5	0.0	.22E+00
187.0	65.0	0.0	0.
187.0	32.5	0.0	.38E-01
187.0	0.0	0.0	.45E+00
187.0	-32.5	0.0	.23E+00
187.0	-65.0	0.0	.12E-01
366.0	64.0	0.0	.79E-02
366.0	32.0	0.0	.85E-01
366.0	0.0	0.0	.34E+00
366.0	-32.0	0.0	.31E+00
366.0	-64.0	0.0	.60E-01
792.0	138.0	0.0	0.
792.0	69.0	0.0	.16E-01
792.0	0.0	0.0	.15E+00
792.0	-69.0	0.0	.65E-01
792.0	-138.0	0.0	.61E-01
1200.0	213.4	0.0	0.
1200.0	106.7	0.0	.13E-01
1200.0	0.0	0.0	.25E-01
1200.0	-106.7	0.0	0.
1200.0	-213.4	0.0	.11E-01
1600.0	224.2	0.0	.22E-01
1600.0	112.1	0.0	.79E-02
1600.0	0.0	0.0	.38E-01
1600.0	-112.1	0.0	.33E-01
1600.0	-224.2	0.0	0.
87.0	0.0	17.8	.47E-01
87.0	0.0	39.4	.44E-01
187.0	0.0	17.8	.41E+00
187.0	0.0	39.4	.15E+00
366.0	0.0	17.8	.82E-01
366.0	0.0	39.4	.47E-01
792.0	0.0	30.5	.28E-01
792.0	0.0	50.9	0.
1200.0	0.0	10.8	.42E-01
1200.0	0.0	30.5	0.
1600.0	0.0	31.1	.44E-02

MAXIMUM VALUE

.65E+00

RUN NUMBER 45
 STABILITY C
 RELEASE HEIGHT (METERS) 29.00
 WIND DIRECTION 135

SAMPLE POSITION (METERS)			CONCENTRATION COEFFICIENT
X	Y	Z	
37.4	28.4	0.0	.49E-01
37.4	14.2	0.0	.14E+00
37.4	0.0	0.0	.12E+00
37.4	-14.2	0.0	.54E-01
37.4	-28.4	0.0	.26E-02
87.0	30.5	0.0	.53E-02
87.0	15.2	0.0	.12E+00
87.0	0.0	0.0	.12E+00
87.0	-15.2	0.0	.39E+00
87.0	-30.5	0.0	.38E+00
187.0	65.0	0.0	.18E-02
187.0	32.5	0.0	.46E-01
187.0	0.0	0.0	.52E+00
187.0	-32.5	0.0	.20E+00
187.0	-65.0	0.0	.71E-02
366.0	64.0	0.0	.11E-01
366.0	32.0	0.0	.11E+00
366.0	0.0	0.0	.34E+00
366.0	-32.0	0.0	.17E+00
366.0	-64.0	0.0	.85E-01
792.0	138.0	0.0	0.
792.0	69.0	0.0	.20E-01
792.0	0.0	0.0	.16E+00
792.0	-69.0	0.0	.49E-01
792.0	-138.0	0.0	.35E-02
1200.0	213.4	0.0	0.
1200.0	106.7	0.0	.21E-01
1200.0	0.0	0.0	.49E-01
1200.0	-106.7	0.0	.68E-01
1200.0	-213.4	0.0	.62E-02
1600.0	224.2	0.0	.44E-02
1600.0	112.1	0.0	.84E-02
1600.0	0.0	0.0	.41E-01
1600.0	-112.1	0.0	.35E-01
1600.0	-224.2	0.0	.18E-02
87.0	0.0	17.8	.15E+00
87.0	0.0	39.4	.17E+00
187.0	0.0	17.8	.16E+00
187.0	0.0	39.4	.22E+00
366.0	0.0	17.8	.11E+00
366.0	0.0	39.4	.49E-01
792.0	0.0	30.5	.64E-01
792.0	0.0	50.0	.41E-01
1200.0	0.0	13.8	.71E-01
1200.0	0.0	30.5	.15E-01
1600.0	0.0	31.1	.32E+00

MAXIMUM VALUE

.52E+00

RUN NUMBER 5G
 STABILITY 0
 RELEASE HEIGHT (METERS) 0.00
 WIND DIRECTION 180

SAMPLE POSITION (METERS)			CONCENTRATION COEFFICIENT
X	Y	Z	
37.4	28.4	0.0	.27E-01
37.4	14.2	0.0	.20E+00
37.4	0.0	0.0	.14E+01
37.4	-14.2	0.0	.31E+01
37.4	-28.4	0.0	.36E+01
87.0	30.5	0.0	.30E+00
87.0	15.2	0.0	.78E+00
87.0	0.0	0.0	.11E+01
87.0	-15.2	0.0	.16E+01
87.0	-30.5	0.0	.13E+01
187.0	65.0	0.0	.31E-01
187.0	32.5	0.0	.31E+00
187.0	0.0	0.0	.60E+00
187.0	-32.5	0.0	.66E+00
187.0	-65.0	0.0	.55E-01
366.0	64.0	0.0	.79E-01
366.0	32.0	0.0	.25E+00
366.0	0.0	0.0	.35E+00
366.0	-32.0	0.0	.45E+00
366.0	-64.0	0.0	.29E+00
792.0	138.0	0.0	.33E-01
792.0	69.0	0.0	.57E-01
792.0	0.0	0.0	.15E+00
792.0	-69.0	0.0	.60E-01
792.0	-138.0	0.0	.66E-01
1200.0	213.4	0.0	.51E-02
1200.0	106.7	0.0	.40E-01
1200.0	0.0	0.0	.63E-01
1200.0	-106.7	0.0	.10E+00
1200.0	-213.4	0.0	.47E-01
1600.0	224.2	0.0	.20E-01
1600.0	112.1	0.0	.20E-01
1600.0	0.0	0.0	.62E-01
1600.0	-112.1	0.0	.58E-01
1600.0	-224.2	0.0	.36E-02
87.0	0.0	17.8	.36E+00
87.0	0.0	39.4	.28E-01
187.0	0.0	17.8	.33E+00
187.0	0.0	39.4	.32E-01
366.0	0.0	17.8	.13E+00
366.0	0.0	39.4	.22E-01
792.0	0.0	30.5	.63E-01
792.0	0.0	50.8	.28E-01
1200.0	0.0	10.8	.55E-01
1200.0	0.0	30.5	.51E-01
1600.0	0.0	31.1	.57E-01

MAXIMUM VALUE

.36E+01

RUN NUMBER 58
 STABILITY C
 RELEASE HEIGHT (METERS) 22.60
 WIND DIRECTION 180

SAMPLE POSITION (METERS)			CONCENTRATION COEFFICIENT
X	Y	Z	
37.4	29.4	0.0	.52E-01
37.4	14.2	0.0	.46E+02
37.4	0.0	0.0	.23E+01
37.4	-14.2	0.0	.25E+01
37.4	-28.4	0.0	.80E+00
87.0	30.5	0.0	.70E+00
87.0	15.2	0.0	.18E+01
87.0	0.0	0.0	.18E+01
87.0	-15.2	0.0	.11E+01
87.0	-30.5	0.0	.41E+00
187.0	65.0	0.0	.64E-01
187.0	32.5	0.0	.66E+00
187.0	0.0	0.0	.72E+00
187.0	-32.5	0.0	.44E+00
187.0	-65.0	0.0	.29E-01
366.0	64.0	0.0	.15E+00
366.0	32.0	0.0	.38E+00
366.0	0.0	0.0	.40E+00
366.0	-32.0	0.0	.35E+00
366.0	-64.0	0.0	.19E+00
792.0	138.0	0.0	.26E-01
792.0	69.0	0.0	.91E-01
792.0	0.0	0.0	.18E+00
792.0	-69.0	0.0	.82E-01
792.0	-138.0	0.0	.50E-01
1200.0	213.4	0.0	.79E-02
1200.0	106.7	0.0	.62E-01
1200.0	0.0	0.0	.78E-01
1200.0	-106.7	0.0	.89E-01
1200.0	-213.4	0.0	.40E-01
1600.0	224.2	0.0	.24E-01
1600.0	112.1	0.0	.29E-01
1600.0	0.0	0.0	.57E-01
1600.0	-112.1	0.0	.52E-01
1600.0	-224.2	0.0	.44E-02
87.0	0.0	17.8	.93E+00
87.0	0.0	39.4	.43E-01
187.0	0.0	17.8	.38E+00
187.0	0.0	39.4	.57E-01
366.0	0.0	17.8	.17E+00
366.0	0.0	39.4	.35E-01
792.0	0.0	30.5	.79E-01
792.0	0.0	51.8	.35E-01
1200.0	0.0	10.8	.65E-01
1200.0	0.0	30.5	.61E-01
1600.0	0.0	31.1	.49E-01

MAXIMUM VALUE

.25E+01

RUN NUMBER 55
 STABILITY 0
 RELEASE HEIGHT (METERS) 29.00
 WIND DIRECTION 180

SAMPLE POSITION (METERS)			CONCENTRATION COEFFICIENT
X	Y	Z	
37.4	28.4	0.0	.44E-02
37.4	14.2	0.0	.14E+02
37.4	0.0	0.0	.35E+01
37.4	-14.2	0.0	.18E+00
37.4	-28.4	0.0	.92E-01
87.0	30.5	0.0	.31E+02
87.0	15.2	0.0	.81E+00
87.0	0.0	0.0	.59E+00
87.0	-15.2	0.0	.19E+00
87.0	-30.5	0.0	.49E-01
187.0	65.0	0.0	.35E-01
187.0	32.5	0.0	.48E+02
187.0	0.0	0.0	.59E+00
187.0	-32.5	0.0	.16E+00
187.0	-65.0	0.0	.11E-01
366.0	64.0	0.0	.13E+00
366.0	32.0	0.0	.41E+00
366.0	0.0	0.0	.40E+01
366.0	-32.0	0.0	.26E+02
366.0	-64.0	0.0	.99E-01
792.0	138.0	0.0	.53E-02
792.0	69.0	0.0	.10E+00
792.0	0.0	0.0	.18E+00
792.0	-69.0	0.0	.51E-01
792.0	-138.0	0.0	.63E-01
1200.0	213.4	0.0	.62E-02
1200.0	106.7	0.0	.22E-01
1200.0	0.0	0.0	.80E-01
1200.0	-106.7	0.0	.91E-01
1200.0	-213.4	0.0	.97E-02
1600.0	224.2	0.0	.19E-01
1600.0	112.1	0.0	.27E-01
1600.0	0.0	0.0	.50E-01
1600.0	-112.1	0.0	.44E-01
1600.0	-224.2	0.0	0.
87.0	0.0	17.8	.59E+00
87.0	0.0	39.4	.11E+00
187.0	0.0	17.8	.50E+00
187.0	0.0	39.4	.11E+00
366.0	0.0	17.8	.20E+00
366.0	0.0	39.4	.84E-01
792.0	0.0	30.5	.81E-01
792.0	0.0	50.9	.37E-01
1200.0	0.0	10.8	.61E-01
1200.0	0.0	30.5	.22E-01
1600.0	0.0	31.1	.50E-01

MAXIMUM VALUE

.81E+00

RUN NUMBER 6G
 STABILITY 0
 RELEASE HEIGHT (METERS) 0.00
 WIND DIRECTION 225

SAMPLE POSITION (METERS)			CONCENTRATION COEFFICIENT
X	Y	Z	
37.4	28.4	0.0	.19E+01
37.4	14.2	0.0	.43E+01
37.4	0.0	0.0	.67E+01
37.4	-14.2	0.0	.18E+00
37.4	-28.4	0.0	.49E+00
87.0	30.5	0.0	.15E+01
87.0	15.2	0.0	.15E+01
87.0	0.0	0.0	.15E+01
87.0	-15.2	0.0	.12E+00
87.0	-30.5	0.0	.48E+00
187.0	65.0	0.0	.33E-01
187.0	32.5	0.0	.28E+00
187.0	0.0	0.0	.44E+00
187.0	-32.5	0.0	.36E+00
187.0	-65.0	0.0	.25E-01
366.0	64.0	0.0	.50E-01
366.0	32.0	0.0	.23E+00
366.0	0.0	0.0	.39E+00
366.0	-32.0	0.0	.35E+00
366.0	-64.0	0.0	.11E+00
792.0	138.0	0.0	.17E-01
792.0	69.0	0.0	.33E-01
792.0	0.0	0.0	.16E+00
792.0	-69.0	0.0	.63E-01
792.0	-138.0	0.0	.62E-01
1200.0	213.4	0.0	.44E-02
1200.0	106.7	0.0	.30E-01
1200.0	0.0	0.0	.48E-01
1200.0	-106.7	0.0	.87E-01
1200.0	-213.4	0.0	.12E-01
1600.0	224.2	0.0	.87E-02
1600.0	112.1	0.0	.51E-02
1600.0	0.0	0.0	.49E-01
1600.0	-112.1	0.0	.47E-01
1600.0	-224.2	0.0	0.
87.0	0.0	17.8	.76E-01
87.0	0.0	39.4	.20E-01
187.0	0.0	17.8	.27E-01
187.0	0.0	39.4	.45E-01
366.0	0.0	17.8	.48E-01
366.0	0.0	39.4	.48E-01
792.0	0.0	30.5	.67E-01
792.0	0.0	50.8	.20E-01
1200.0	0.0	10.8	.60E-01
1200.0	0.0	30.5	.41E-01
1600.0	0.0	31.1	.40E-01

MAXIMUM VALUE

.67E+01

RUN NUMBER 68
 STABILITY C
 RELEASE HEIGHT (METERS) 22.68
 WIND DIRECTION 225

SAMPLE POSITION (METERS)			CONCENTRATION COEFFICIENT
X	Y	Z	
37.4	28.4	0.0	.62E-02
37.4	14.2	0.0	.65E+00
37.4	0.0	0.0	.37E+00
37.4	-14.2	0.0	.59E-01
37.4	-28.4	0.0	.11E-01
87.0	30.5	0.0	.18E+00
87.0	15.2	0.0	.76E+00
87.0	0.0	0.0	.10E+01
87.0	-15.2	0.0	.39E+00
87.0	-30.5	0.0	.34E-01
187.0	65.0	0.0	.11E-01
187.0	32.5	0.0	.24E+00
187.0	0.0	0.0	.50E+00
187.0	-32.5	0.0	.22E+00
187.0	-65.0	0.0	.13E-01
366.0	64.0	0.0	.46E-01
366.0	32.0	0.0	.26E+00
366.0	0.0	0.0	.48E+00
366.0	-32.0	0.0	.33E+00
366.0	-64.0	0.0	.57E-01
792.0	138.0	0.0	.24E-01
792.0	69.0	0.0	.45E-01
792.0	0.0	0.0	.21E+00
792.0	-69.0	0.0	.78E-01
792.0	-138.0	0.0	.64E-01
1200.0	213.4	0.0	.53E-02
1200.0	106.7	0.0	.41E-01
1200.0	0.0	0.0	.64E-01
1200.0	-106.7	0.0	.94E-01
1200.0	-213.4	0.0	.17E-01
1600.0	224.2	0.0	.15E-01
1600.0	112.1	0.0	.13E-01
1600.0	0.0	0.0	.57E-01
1600.0	-112.1	0.0	.50E-01
1600.0	-224.2	0.0	0.
87.0	0.0	17.8	.57E+00
87.0	0.0	39.4	.88E-01
187.0	0.0	17.8	.95E-01
187.0	0.0	39.4	.13E+00
366.0	0.0	17.8	.10E+00
366.0	0.0	39.4	.13E+00
792.0	0.0	30.5	.88E-01
792.0	0.0	50.8	.39E-01
1200.0	0.0	10.8	.78E-01
1200.0	0.0	30.5	.57E-01
1600.0	0.0	31.1	.47E-01

MAXIMUM VALUE

.10E+01

RUN NUMBER 65
 STABILITY C
 RELEASE HEIGHT (METERS) 29.00
 WIND DIRECTION 225

SAMPLE POSITION (METERS)			CONCENTRATION COEFFICIENT
X	Y	Z	
37.4	28.4	0.0	.26E-02
37.4	14.2	0.0	.53E-01
37.4	0.0	0.0	.37E-01
37.4	-14.2	0.0	.79E-02
37.4	-28.4	0.0	.44E-02
87.0	30.5	0.0	.31E-01
87.0	15.2	0.0	.35E+00
87.0	0.0	0.0	.44E+00
87.0	-15.2	0.0	.13E+00
87.0	-30.5	0.0	.79E-02
187.0	65.0	0.0	.26E-02
187.0	32.5	0.0	.16E+00
187.0	0.0	0.0	.64E+00
187.0	-32.5	0.0	.16E+00
187.0	-65.0	0.0	.62E-02
366.0	64.0	0.0	.24E-01
366.0	32.0	0.0	.25E+00
366.0	0.0	0.0	.50E+00
366.0	-32.0	0.0	.32E+00
366.0	-64.0	0.0	.70E-01
792.0	138.0	0.0	.26E-02
792.0	69.0	0.0	.39E-01
792.0	0.0	0.0	.20E+00
792.0	-69.0	0.0	.66E-01
792.0	-138.0	0.0	.29E-01
1200.0	213.4	0.0	0.
1200.0	106.7	0.0	.37E-01
1200.0	0.0	0.0	.84E-01
1200.0	-106.7	0.0	.98E-01
1200.0	-213.4	0.0	.44E-01
1600.0	224.2	0.0	.11E-01
1600.0	112.1	0.0	.12E-01
1600.0	0.0	0.0	.56E-01
1600.0	-112.1	0.0	.50E-01
1600.0	-224.2	0.0	0.
87.0	0.0	17.8	.74E+00
87.0	0.0	39.4	.62E-01
187.0	0.0	17.8	.24E+00
187.0	0.0	39.4	.57E+00
366.0	0.0	17.8	.91E-01
366.0	0.0	39.4	.11E+00
792.0	0.0	30.5	.87E-01
792.0	0.0	50.6	.36E-01
1200.0	0.0	10.8	.71E-01
1200.0	0.0	30.5	.39E-01
1600.0	0.0	31.1	.52E-01

MAXIMUM VALUE

.74E+00

RUN NUMBER 76
 STABILITY 0
 RELEASE HEIGHT (METERS) 0.00
 WIND DIRECTION 270

SAMPLE POSITION (METERS)			CONCENTRATION COEFFICIENT
X	Y	Z	
37.4	28.4	0.0	.46E+00
37.4	14.2	0.0	.93E+00
37.4	0.0	0.0	.21E+01
37.4	-14.2	0.0	.43E+01
37.4	-28.4	0.0	.51E+01
87.0	30.5	0.0	.29E+00
87.0	15.2	0.0	.67E+00
87.0	0.0	0.0	.80E+00
87.0	-15.2	0.0	.71E+00
87.0	-30.5	0.0	.82E+00
187.0	65.0	0.0	.21E-01
187.0	32.5	0.0	.20E+00
187.0	0.0	0.0	.30E+00
187.0	-32.5	0.0	.42E+00
187.0	-65.0	0.0	.36E+00
366.0	64.0	0.0	.31E-01
366.0	32.0	0.0	.12E+00
366.0	0.0	0.0	.21E+00
366.0	-32.0	0.0	.16E+00
366.0	-64.0	0.0	.27E+00
792.0	138.0	0.0	.36E-02
792.0	69.0	0.0	.28E-01
792.0	0.0	0.0	.98E-01
792.0	-69.0	0.0	.80E-02
792.0	-138.0	0.0	.94E-01
1200.0	213.4	0.0	.29E-02
1200.0	106.7	0.0	.80E-02
1200.0	0.0	0.0	.33E-01
1200.0	-106.7	0.0	.53E-01
1200.0	-213.4	0.0	.23E-01
1600.0	224.2	0.0	.29E-02
1600.0	112.1	0.0	.80E-02
1600.0	0.0	0.0	.50E-01
1600.0	-112.1	0.0	.47E-01
1600.0	-224.2	0.0	.15E-02
87.0	0.0	17.8	.26E+00
87.0	0.0	39.4	.10E+00
187.0	0.0	17.8	.23E+00
187.0	0.0	39.4	.22E+00
366.0	0.0	17.8	.54E-01
366.0	0.0	39.4	.47E-01
792.0	0.0	30.5	.55E-01
792.0	0.0	50.3	.30E-01
1200.0	0.0	10.8	.41E-01
1200.0	0.0	30.5	.15E-01
1600.0	0.0	31.1	.25E-01

MAXIMUM VALUE

.51E+01

RUN NUMBER 78
 STABILITY C
 RELEASE HEIGHT (METERS) 22.60
 WIND DIRECTION 270

SAMPLE POSITION (METERS)			CONCENTRATION COEFFICIENT
X	Y	Z	
37.4	28.4	0.0	.12E+01
37.4	14.2	0.0	.28E+01
37.4	0.0	0.0	.31E+01
37.4	-14.2	0.0	.23E+01
37.4	-28.4	0.0	.54E+00
87.0	30.5	0.0	.13E+01
87.0	15.2	0.0	.20E+01
87.0	0.0	0.0	.27E+01
87.0	-15.2	0.0	.21E+01
87.0	-30.5	0.0	.53E+00
187.0	65.0	0.0	.55E-01
187.0	32.5	0.0	.60E+00
187.0	0.0	0.0	.71E+00
187.0	-32.5	0.0	.47E+00
187.0	-65.0	0.0	.71E-01
366.0	64.0	0.0	.87E-01
366.0	32.0	0.0	.31E+00
366.0	0.0	0.0	.38E+00
366.0	-32.0	0.0	.29E+00
366.0	-64.0	0.0	.23E+00
792.0	138.0	0.0	.44E-02
792.0	69.0	0.0	.66E-01
792.0	0.0	0.0	.16E+00
792.0	-69.0	0.0	.34E-01
792.0	-138.0	0.0	.85E-01
1200.0	213.4	0.0	.53E-02
1200.0	106.7	0.0	.19E-01
1200.0	0.0	0.0	.55E-01
1200.0	-106.7	0.0	.77E-01
1200.0	-213.4	0.0	.21E-01
1600.0	224.2	0.0	0.
1600.0	112.1	0.0	.17E-01
1600.0	0.0	0.0	.55E-01
1600.0	-112.1	0.0	.49E-01
1600.0	-224.2	0.0	.88E-03
87.0	0.0	17.8	.59E+00
87.0	0.0	39.4	.20E+00
187.0	0.0	17.8	.35E+00
187.0	0.0	39.4	.32E+00
366.0	0.0	17.8	.74E-01
366.0	0.0	39.4	.64E-01
792.0	0.0	30.5	.73E-01
792.0	0.0	50.8	.34E-01
1200.0	0.0	19.8	.63E-01
1200.0	0.0	30.5	.12E-01
1600.0	0.0	31.1	.28E-01

MAXIMUM VALUE

.31E+01

RUN NUMBER 75
 STABILITY C
 RELEASE HEIGHT (METERS) 29.00
 WIND DIRECTION 270

SAMPLE POSITION (METERS)			CONCENTRATION COEFFICIENT
X	Y	Z	
37.4	28.4	0.0	.200+00
37.4	14.2	0.0	.68E+00
37.4	0.0	0.0	.75E+00
37.4	-14.2	0.0	.72E+00
37.4	-28.4	0.0	.16E+00
87.0	30.5	0.0	.31E+00
87.0	15.2	0.0	.12E+01
87.0	0.0	0.0	.19E+01
87.0	-15.2	0.0	.16E+01
87.0	-30.5	0.0	.34E+00
187.0	65.0	0.0	.23E-01
187.0	32.5	0.0	.41E+00
187.0	0.0	0.0	.85E+00
187.0	-32.5	0.0	.55E+00
187.0	-65.0	0.0	.63E-01
366.0	64.0	0.0	.68E-01
366.0	32.0	0.0	.25E+00
366.0	0.0	0.0	.36E+00
366.0	-32.0	0.0	.44E+00
366.0	-64.0	0.0	.24E+00
792.0	138.0	0.0	0.
792.0	69.0	0.0	.47E-01
792.0	0.0	0.0	.14E+00
792.0	-69.0	0.0	.13E+00
792.0	-138.0	0.0	.81E-01
1200.0	213.4	0.0	.88E-02
1200.0	106.7	0.0	.23E-01
1200.0	0.0	0.0	.62E-01
1200.0	-106.7	0.0	.98E-01
1200.0	-213.4	0.0	.88E-01
1600.0	224.2	0.0	.12E-01
1600.0	112.1	0.0	.11E-01
1600.0	0.0	0.0	.50E-01
1600.0	-112.1	0.0	.48E-01
1600.0	-224.2	0.0	.68E-03
87.0	0.0	17.8	.44E+00
87.0	0.0	39.4	.45E-01
187.0	0.0	17.8	.37E+00
187.0	0.0	39.4	.55E-01
366.0	0.0	17.8	.67E-01
366.0	0.0	39.4	.37E-01
792.0	0.0	30.5	.71E-01
792.0	0.0	50.8	.30E-01
1200.0	0.0	10.8	.49E-01
1200.0	0.0	30.5	.13E-01
1600.0	0.0	31.1	.28E-01

MAXIMUM VALUE

.19E+01

RUN NUMBER 86
 STABILITY C
 RELEASE HEIGHT (METERS) 0.00
 WIND DIRECTION 315

SAMPLE POSITION (METERS)			CONCENTRATION COEFFICIENT
X	Y	Z	
37.4	28.4	0.0	.44E-01
37.4	14.2	0.0	.13E+00
37.4	0.0	0.0	.77E+00
37.4	-14.2	0.0	.15E+01
37.4	-28.4	0.0	.24E+01
87.0	30.5	0.0	.87E-01
87.0	15.2	0.0	.26E+00
87.0	0.0	0.0	.72E+00
87.0	-15.2	0.0	.16E+01
87.0	-30.5	0.0	.12E+01
187.0	65.0	0.0	.89E-02
187.0	32.5	0.0	.16E+00
187.0	0.0	0.0	.47E+00
187.0	-32.5	0.0	.60E+00
187.0	-65.0	0.0	.13E+00
366.0	64.0	0.0	.36E-01
366.0	32.0	0.0	.14E+00
366.0	0.0	0.0	.32E+00
366.0	-32.0	0.0	.40E+00
366.0	-64.0	0.0	.20E+00
792.0	138.0	0.0	.52E-02
792.0	69.0	0.0	.31E-01
792.0	0.0	0.0	.13E+00
792.0	-69.0	0.0	.21E-01
792.0	-138.0	0.0	.30E-02
1200.0	213.4	0.0	0.
1200.0	106.7	0.0	.26E-01
1200.0	0.0	0.0	.66E-01
1200.0	-106.7	0.0	.81E-01
1200.0	-213.4	0.0	.13E-01
1600.0	224.2	0.0	.74E-03
1600.0	112.1	0.0	.74E-02
1600.0	0.0	0.0	.35E-01
1600.0	-112.1	0.0	.33E-01
1600.0	-224.2	0.0	0.
87.0	0.0	17.8	.38E+00
87.0	0.0	39.4	.24E-01
187.0	0.0	17.8	.29E+00
187.0	0.0	39.4	.82E-01
366.0	0.0	17.8	.72E-01
366.0	0.0	39.4	.38E-01
792.0	0.0	30.5	.70E-01
792.0	0.0	50.8	.37E-01
1200.0	0.0	10.8	.62E-01
1200.0	0.0	30.5	.16E-01
1600.0	0.0	31.1	.34E-01

MAXIMUM VALUE

.24E+01

RUN NUMBER 82
 STABILITY 0
 RELEASE HEIGHT (METERS) 22.60
 WIND DIRECTION 315

SAMPLE POSITION (METERS)			CONCENTRATION COEFFICIENT
X	Y	Z	
37.4	28.4	0.0	.91E-01
37.4	14.2	0.0	.30E+00
37.4	0.0	0.0	.53E+00
37.4	-14.2	0.0	.24E+00
37.4	-28.4	0.0	.50E-01
87.0	30.5	0.0	.25E+00
87.0	15.2	0.0	.49E+00
87.0	0.0	0.0	.53E+00
87.0	-15.2	0.0	.30E+00
87.0	-30.5	0.0	.38E-01
187.0	65.0	0.0	.22E-01
187.0	32.5	0.0	.26E+00
187.0	0.0	0.0	.41E+00
187.0	-32.5	0.0	.11E+00
187.0	-65.0	0.0	.54E-02
366.0	64.0	0.0	.65E-01
366.0	32.0	0.0	.22E+00
366.0	0.0	0.0	.30E+00
366.0	-32.0	0.0	.19E+00
366.0	-64.0	0.0	.37E-01
792.0	138.0	0.0	0.
792.0	69.0	0.0	.50E-01
792.0	0.0	0.0	.15E+00
792.0	-69.0	0.0	.17E-01
792.0	-138.0	0.0	0.
1200.0	213.4	0.0	.90E-03
1200.0	106.7	0.0	.40E-01
1200.0	0.0	0.0	.74E-01
1200.0	-106.7	0.0	.58E-01
1200.0	-213.4	0.0	.72E-02
1600.0	224.2	0.0	.36E-02
1600.0	112.1	0.0	.17E-01
1600.0	0.0	0.0	.34E-01
1600.0	-112.1	0.0	.30E-01
1600.0	-224.2	0.0	0.
87.0	0.0	17.8	.69E+00
87.0	0.0	39.4	.15E+00
187.0	0.0	17.8	.39E+00
187.0	0.0	39.4	.25E+00
366.0	0.0	17.8	.86E-01
366.0	0.0	39.4	.44E-01
792.0	0.0	30.5	.89E-01
792.0	0.0	50.8	.55E-01
1200.0	0.0	10.8	.70E-01
1200.0	0.0	30.5	.22E-01
1600.0	0.0	31.1	.41E-01

MAXIMUM VALUE

.69E+00

RUN NUMBER 85
 STABILITY C
 RELEASE HEIGHT (METERS) 29.00
 WIND DIRECTION 315

SAMPLE POSITION (METERS)			CONCENTRATION COEFFICIENT
X	Y	Z	
37.4	28.4	0.0	.40E-01
37.4	14.2	0.0	.13E+00
37.4	0.0	0.0	.44E+00
37.4	-14.2	0.0	.28E+00
37.4	-28.4	0.0	.50E-01
87.0	30.5	0.0	.13E+00
87.0	15.2	0.0	.43E+00
87.0	0.0	0.0	.58E+00
87.0	-15.2	0.0	.38E+00
87.0	-30.5	0.0	.58E-01
187.0	65.0	0.0	.13E-01
187.0	32.5	0.0	.17E+00
187.0	0.0	0.0	.38E+00
187.0	-32.5	0.0	.15E+00
187.0	-65.0	0.0	.81E-02
366.0	64.0	0.0	.90E-02
366.0	32.0	0.0	.47E-01
366.0	0.0	0.0	.26E+00
366.0	-32.0	0.0	.21E+00
366.0	-64.0	0.0	.65E-01
792.0	138.0	0.0	.18E-02
792.0	69.0	0.0	.42E-01
792.0	0.0	0.0	.12E+00
792.0	-69.0	0.0	.45E-01
792.0	-138.0	0.0	.27E-02
1200.0	213.4	0.0	.18E-02
1200.0	106.7	0.0	.33E-01
1200.0	0.0	0.0	.35E-01
1200.0	-106.7	0.0	.66E-01
1200.0	-213.4	0.0	.16E-01
1600.0	224.2	0.0	.27E-02
1600.0	112.1	0.0	.18E-01
1600.0	0.0	0.0	.40E-01
1600.0	-112.1	0.0	.35E-01
1600.0	-224.2	0.0	0.
87.0	0.0	17.8	.25E+00
87.0	0.0	39.4	.15E+00
187.0	0.0	17.8	.35E+00
187.0	0.0	39.4	.20E+00
366.0	0.0	17.8	.79E-01
366.0	0.0	39.4	.45E-01
792.0	0.0	30.5	.77E-01
792.0	0.0	50.8	.47E-01
1200.0	0.0	10.8	.57E-01
1200.0	0.0	30.5	.25E-01
1600.0	0.0	31.1	.45E-01

MAXIMUM VALUE

.58E+00

RUN NUMBER 9G
 STABILITY D
 RELEASE HEIGHT (METERS) 0.0G
 WIND DIRECTION G

SAMPLE POSITION (METERS)			CONCENTRATION COEFFICIENT
X	Y	Z	
37.4	28.4	0.0	.13E-01
37.4	14.2	0.0	.17E-01
37.4	0.0	0.0	.15E+02
37.4	-14.2	0.0	.22E-01
37.4	-28.4	0.0	.17E-01
87.0	30.5	0.0	.27E-01
87.0	15.2	0.0	.29E-01
87.0	0.0	0.0	.12E+02
87.0	-15.2	0.0	.72E-01
87.0	-30.5	0.0	.17E+02
187.0	65.0	0.0	.35E-01
187.0	32.5	0.0	.44E-01
187.0	0.0	0.0	.38E+01
187.0	-32.5	0.0	.44E-01
187.0	-65.0	0.0	.22E-01
366.0	64.0	0.0	.16E-01
366.0	32.0	0.0	.34E-01
366.0	0.0	0.0	.44E+02
366.0	-32.0	0.0	.25E-01
366.0	-64.0	0.0	.11E-01
792.0	138.0	0.0	.46E-01
792.0	69.0	0.0	.65E-01
792.0	0.0	0.0	.22E+02
792.0	-69.0	0.0	.65E-01
792.0	-138.0	0.0	.83E-01
1200.0	213.4	0.0	.31E-01
1200.0	106.7	0.0	.76E-01
1200.0	0.0	0.0	.20E+02
1200.0	-106.7	0.0	.55E-01
1200.0	-213.4	0.0	.22E-01
1600.0	224.2	0.0	.20E-01
1600.0	112.1	0.0	.72E-01
1600.0	0.0	0.0	.14E+02
1600.0	-112.1	0.0	.52E-01
1600.0	-224.2	0.0	.22E-01
87.0	0.0	17.8	.87E-01
87.0	0.0	39.4	.44E-01
187.0	0.0	17.8	.31E+02
187.0	0.0	39.4	.17E-01
366.0	0.0	17.8	.15E+02
366.0	0.0	39.4	.11E-01
792.0	0.0	30.5	.13E-01
792.0	0.0	50.8	.24E-01
1200.0	0.0	10.8	.19E-01
1200.0	0.0	30.5	.98E-02
1600.0	0.0	31.1	.28E-01

MAXIMUM VALUE

.15E+02

RUN NUMBER 98
 STABILITY C
 RELEASE HEIGHT (METERS) 22.60
 WIND DIRECTION 0

SAMPLE POSITION (METERS)			CONCENTRATION COEFFICIENT
X	Y	Z	
37.4	28.4	0.0	.44E-01
37.4	14.2	0.0	.46E-01
37.4	0.0	0.0	.61E-01
37.4	-14.2	0.0	.44E-01
37.4	-28.4	0.0	.44E-01
87.0	30.5	0.0	.49E-01
87.0	15.2	0.0	.51E-01
87.0	0.0	0.0	.65E-01
87.0	-15.2	0.0	.49E-01
87.0	-30.5	0.0	.49E-01
187.0	65.0	0.0	.46E-01
187.0	32.5	0.0	.45E-01
187.0	0.0	0.0	.64E-01
187.0	-32.5	0.0	.16E-01
187.0	-65.0	0.0	.27E-01
366.0	64.0	0.0	.11E-01
366.0	32.0	0.0	.15E-01
366.0	0.0	0.0	.12E+00
366.0	-32.0	0.0	.28E-01
366.0	-64.0	0.0	.11E-01
792.0	138.0	0.0	.18E-01
792.0	69.0	0.0	.57E-01
792.0	0.0	0.0	.20E+00
792.0	-69.0	0.0	.87E-01
792.0	-138.0	0.0	.47E-01
1200.0	213.4	0.0	.48E-01
1200.0	106.7	0.0	.92E-01
1200.0	0.0	0.0	.17E+00
1200.0	-106.7	0.0	.57E-01
1200.0	-213.4	0.0	.24E-01
1600.0	224.2	0.0	.22E-01
1600.0	112.1	0.0	.68E-01
1600.0	0.0	0.0	.10E+00
1600.0	-112.1	0.0	.44E-01
1600.0	-224.2	0.0	.24E-01
87.0	0.0	17.8	.11E+01
87.0	0.0	39.4	.44E+00
187.0	0.0	17.8	.51E+00
187.0	0.0	39.4	.24E-01
366.0	0.0	17.8	.92E-01
366.0	0.0	39.4	.87E-02
792.0	0.0	30.5	.11E-01
792.0	0.0	50.8	.35E-01
1200.0	0.0	10.8	.22E-01
1200.0	0.0	30.5	.11E-01
1600.0	0.0	31.1	.26E-01

MAXIMUM VALUE

.11E+01

RUN NUMBER 9S
 STABILITY 0
 RELEASE HEIGHT (METERS) 29.00
 WIND DIRECTION 0

SAMPLE POSITION (METERS)			CONCENTRATION COEFFICIENT
X	Y	Z	
37.4	28.4	0.0	.22E-01
37.4	14.2	0.0	.22E-01
37.4	0.0	0.0	.26E-01
37.4	-14.2	0.0	.22E-01
37.4	-28.4	0.0	.22E-01
87.0	30.5	0.0	.31E-01
87.0	15.2	0.0	.31E-01
87.0	0.0	0.0	.37E-01
87.0	-15.2	0.0	.31E-01
87.0	-30.5	0.0	.28E-01
187.0	65.0	0.0	.26E-01
187.0	32.5	0.0	.31E-01
187.0	0.0	0.0	.53E-01
187.0	-32.5	0.0	.17E-01
187.0	-65.0	0.0	.17E-01
366.0	64.0	0.0	.11E-01
366.0	32.0	0.0	.14E-01
366.0	0.0	0.0	.65E-01
366.0	-32.0	0.0	.22E-01
366.0	-64.0	0.0	.11E-01
792.0	138.0	0.0	.16E-01
792.0	69.0	0.0	.46E-01
792.0	0.0	0.0	.17E+00
792.0	-69.0	0.0	.39E-01
792.0	-138.0	0.0	.32E-01
1200.0	213.4	0.0	.33E-01
1200.0	106.7	0.0	.81E-01
1200.0	0.0	0.0	.14E+00
1200.0	-106.7	0.0	.37E-01
1200.0	-213.4	0.0	.23E-01
1600.0	224.2	0.0	.21E-01
1600.0	112.1	0.0	.52E-01
1600.0	0.0	0.0	.11E+00
1600.0	-112.1	0.0	.34E-01
1600.0	-224.2	0.0	.22E-01
87.0	0.0	17.8	.13E+01
87.0	0.0	39.4	.11E+01
187.0	0.0	17.8	.29E+00
187.0	0.0	39.4	.24E-01
366.0	0.0	17.8	.10E+00
366.0	0.0	39.4	.87E-02
792.0	0.0	30.5	.87E-02
792.0	0.0	50.8	.20E-01
1200.0	0.0	10.8	.17E-01
1200.0	0.0	30.5	.11E-01
1600.0	0.0	31.1	.23E-01

MAXIMUM VALUE

.13E+01

TABLE V. Data, Slightly Stable

RUN NUMBER 16
 STABILITY E
 RELEASE HEIGHT (METERS) 0.00
 WIND DIRECTION 0

SAMPLE POSITION (METERS)			CONCENTRATION COEFFICIENT
X	Y	Z	
37.4	28.4	0.0	.22E+01
37.4	14.2	0.0	.19E+01
37.4	0.0	0.0	.80E+00
37.4	-14.2	0.0	.21E+00
37.4	-28.4	0.0	.10E+00
87.0	30.5	0.0	.43E+00
87.0	15.2	0.0	.10E+01
87.0	0.0	0.0	.96E+00
87.0	-15.2	0.0	.32E-01
87.0	-30.5	0.0	0.
187.0	65.0	0.0	.15E-01
187.0	32.5	0.0	.72E-01
187.0	0.0	0.0	.95E-01
187.0	-32.5	0.0	.38E-03
187.0	-65.0	0.0	.19E-02
366.0	64.0	0.0	0.
366.0	32.0	0.0	.38E-02
366.0	0.0	0.0	.73E-01
366.0	-32.0	0.0	.48E-01
366.0	-64.0	0.0	.91E-01
792.0	138.0	0.0	.38E-02
792.0	69.0	0.0	.24E-01
792.0	0.0	0.0	.15E+00
792.0	-69.0	0.0	.75E-01
792.0	-138.0	0.0	.47E-01
1200.0	213.4	0.0	.93E-02
1200.0	106.7	0.0	.13E+00
1200.0	0.0	0.0	.11E+00
1200.0	-106.7	0.0	.83E-01
1200.0	-213.4	0.0	.16E-01
1600.0	224.2	0.0	.19E-01
1600.0	112.1	0.0	.99E-01
1600.0	0.0	0.0	.10E+00
1600.0	-112.1	0.0	.25E-01
1600.0	-224.2	0.0	.38E-03
87.0	0.0	17.8	.86E-01
87.0	0.0	39.4	.19E-01
187.0	0.0	17.8	.25E+00
187.0	0.0	39.4	.19E-01
366.0	0.0	17.8	.19E-01
366.0	0.0	39.4	.17E-02
792.0	0.0	30.5	.33E-01
792.0	0.0	50.8	.76E-03
1200.0	0.0	10.8	.25E-01
1200.0	0.0	30.5	0.
1600.0	0.0	31.1	.32E-02

MAXIMUM VALUE

.22E+01

RUN NUMBER 18
 STABILITY E
 RELEASE HEIGHT (METERS) 22.60
 WIND DIRECTION 0

SAMPLE POSITION (METERS)			CONCENTRATION COEFFICIENT
X	Y	Z	
37.4	28.4	0.0	.69E-02
37.4	14.2	0.0	.80E-01
37.4	0.0	0.0	.17E+00
37.4	-14.2	0.0	.12E+00
37.4	-28.4	0.0	.35E-01
87.0	30.5	0.0	.39E-02
87.0	15.2	0.0	.14E+00
87.0	0.0	0.0	.13E+00
87.0	-15.2	0.0	.35E-01
87.0	-30.5	0.0	0.
187.0	65.0	0.0	0.
187.0	32.5	0.0	.18E-01
187.0	0.0	0.0	.38E-01
187.0	-32.5	0.0	.18E-01
187.0	-65.0	0.0	0.
366.0	64.0	0.0	0.
366.0	32.0	0.0	0.
366.0	0.0	0.0	.10E-01
366.0	-32.0	0.0	.62E-02
366.0	-64.0	0.0	.23E-01
792.0	138.0	0.0	0.
792.0	69.0	0.0	0.
792.0	0.0	0.0	.46E-01
792.0	-69.0	0.0	.44E-01
792.0	-138.0	0.0	.27E-01
1200.0	213.4	0.0	.69E-03
1200.0	106.7	0.0	.50E-01
1200.0	0.0	0.0	.81E-01
1200.0	-106.7	0.0	.56E-01
1200.0	-213.4	0.0	.99E-02
1600.0	224.2	0.0	.12E-01
1600.0	112.1	0.0	.54E-01
1600.0	0.0	0.0	.57E-01
1600.0	-112.1	0.0	.15E-01
1600.0	-224.2	0.0	0.
87.0	0.0	17.8	.36E+00
87.0	0.0	39.4	.41E-01
187.0	0.0	17.8	.79E+00
187.0	0.0	39.4	.65E-01
366.0	0.0	17.8	.55E-01
366.0	0.0	39.4	.65E-02
792.0	0.0	30.5	.77E-01
792.0	0.0	50.8	.69E-02
1200.0	0.0	10.8	.67E-01
1200.0	0.0	30.5	.11E-01
1600.0	0.0	31.1	.10E-01

MAXIMUM VALUE

.79E+00

RUN NUMBER 15
 STABILITY E
 RELEASE HEIGHT (METERS) 29.00
 WIND DIRECTION 0

SAMPLE POSITION (METERS)			CONCENTRATION COEFFICIENT
X	Y	Z	
37.4	28.4	0.0	0.
37.4	14.2	0.0	0.
37.4	0.0	0.0	.12E-02
37.4	-14.2	0.0	0.
37.4	-28.4	0.0	0.
87.0	30.5	0.0	.46E-03
87.0	15.2	0.0	.92E-03
87.0	0.0	0.0	.28E-02
87.0	-15.2	0.0	0.
87.0	-30.5	0.0	0.
187.0	65.0	0.0	0.
187.0	32.5	0.0	0.
187.0	0.0	0.0	.12E-02
187.0	-32.5	0.0	0.
187.0	-65.0	0.0	0.
366.0	64.0	0.0	0.
366.0	32.0	0.0	0.
366.0	0.0	0.0	.46E-03
366.0	-32.0	0.0	.30E-02
366.0	-64.0	0.0	.28E-02
792.0	138.0	0.0	0.
792.0	69.0	0.0	0.
792.0	0.0	0.0	.51E-02
792.0	-69.0	0.0	.21E-01
792.0	-138.0	0.0	.32E-02
1200.0	213.4	0.0	.12E-02
1200.0	106.7	0.0	.58E-02
1200.0	0.0	0.0	.22E-01
1200.0	-106.7	0.0	.90E-02
1200.0	-213.4	0.0	.30E-02
1600.0	224.2	0.0	.35E-02
1600.0	112.1	0.0	.24E-01
1600.0	0.0	0.0	.27E-01
1600.0	-112.1	0.0	.41E-02
1600.0	-224.2	0.0	0.
87.0	0.0	17.8	.78E+00
87.0	0.0	39.4	.11E+01
187.0	0.0	17.8	.39E+00
187.0	0.0	39.4	.65E+00
366.0	0.0	17.8	.77E-01
366.0	0.0	39.4	.11E+00
792.0	0.0	30.5	.15E+00
792.0	0.0	50.8	.41E-01
1200.0	0.0	10.8	.16E+00
1200.0	0.0	30.5	.27E-01
1600.0	0.0	31.1	.33E-01

MAXIMUM VALUE

.11E+01

RUN NUMBER 2G
 STABILITY E
 RELEASE HEIGHT (METERS) 0.00
 WIND DIRECTION 45

SAMPLE POSITION (METERS)			CONCENTRATION COEFFICIENT
X	Y	Z	
37.4	28.4	0.0	.27E+00
37.4	14.2	0.0	.70E+00
37.4	0.0	0.0	.15E+01
37.4	-14.2	0.0	.13E+00
37.4	-28.4	0.0	.36E-02
87.0	32.5	0.0	.15E-01
87.0	15.2	0.0	.24E+00
87.0	0.0	0.0	.24E+00
87.0	-15.2	0.0	.11E-01
87.0	-32.5	0.0	0.
187.0	65.0	0.0	0.
187.0	32.5	0.0	.13E-02
187.0	0.0	0.0	.57E-01
187.0	-32.5	0.0	.82E-02
187.0	-65.0	0.0	0.
366.0	64.0	0.0	0.
366.0	32.0	0.0	.76E-03
366.0	0.0	0.0	.16E-01
366.0	-32.0	0.0	.54E-01
366.0	-64.0	0.0	.37E-01
792.0	138.0	0.0	0.
792.0	69.0	0.0	.81E-01
792.0	0.0	0.0	.75E-01
792.0	-69.0	0.0	.16E-01
792.0	-138.0	0.0	.30E-02
1200.0	213.4	0.0	.19E-01
1200.0	106.7	0.0	.40E-01
1200.0	0.0	0.0	.87E-02
1200.0	-106.7	0.0	.47E-01
1200.0	-213.4	0.0	.12E-01
1600.0	224.2	0.0	.48E-02
1600.0	112.1	0.0	.35E-01
1600.0	0.0	0.0	.36E-01
1600.0	-112.1	0.0	.11E-01
1600.0	-224.2	0.0	.19E-03
87.0	0.0	17.8	.97E-01
87.0	0.0	39.4	.12E-01
187.0	0.0	17.8	.62E+00
187.0	0.0	39.4	.16E+00
366.0	0.0	17.8	.63E-01
366.0	0.0	39.4	.17E-01
792.0	0.0	30.5	.89E-01
792.0	0.0	50.8	.65E-02
1200.0	0.0	10.8	.25E-01
1200.0	0.0	30.5	.15E-02
1600.0	0.0	31.1	.24E-01

MAXIMUM VALUE

.15E+01

RUN NUMBER 28
 STABILITY E
 RELEASE HEIGHT (METERS) 22.60
 WIND DIRECTION 45

SAMPLE POSITION (METERS)			CONCENTRATION COEFFICIENT
X	Y	Z	
37.4	28.4	0.0	0.
37.4	14.2	0.0	0.
37.4	0.0	0.0	.28E-01
37.4	-14.2	0.0	.25E-02
37.4	-28.4	0.0	0.
87.0	30.5	0.0	.53E-02
87.0	15.2	0.0	.55E-02
87.0	0.0	0.0	.12E-01
87.0	-15.2	0.0	0.
87.0	-30.5	0.0	0.
187.0	65.0	0.0	0.
187.0	32.5	0.0	0.
187.0	0.0	0.0	.37E-02
187.0	-32.5	0.0	.23E-03
187.0	-65.0	0.0	0.
366.0	64.0	0.0	0.
366.0	32.0	0.0	.18E-02
366.0	0.0	0.0	.23E-02
366.0	-32.0	0.0	.11E-01
366.0	-64.0	0.0	.81E-02
792.0	138.0	0.0	0.
792.0	69.0	0.0	.25E-01
792.0	0.0	0.0	.23E-01
792.0	-69.0	0.0	.39E-01
792.0	-138.0	0.0	.30E-01
1200.0	213.4	0.0	.21E-02
1200.0	106.7	0.0	.12E-01
1200.0	0.0	0.0	.21E-02
1200.0	-106.7	0.0	.26E-01
1200.0	-213.4	0.0	.78E-02
1600.0	224.2	0.0	.28E-02
1600.0	112.1	0.0	.30E-01
1600.0	0.0	0.0	.33E-01
1600.0	-112.1	0.0	.94E-02
1600.0	-224.2	0.0	.58E-02
87.0	0.0	17.8	.20E+00
87.0	0.0	39.4	.39E-01
187.0	0.0	17.8	.75E+00
187.0	0.0	39.4	.20E+00
366.0	0.0	17.8	.67E-01
366.0	0.0	39.4	.19E-01
792.0	0.0	30.5	.12E+00
792.0	0.0	50.8	.19E-01
1200.0	0.0	10.8	.44E-01
1200.0	0.0	30.5	.16E-01
1600.0	0.0	31.1	.52E-01

MAXIMUM VALUE

.75E+00

RUN NUMBER 2S
 STABILITY E
 RELEASE HEIGHT (METERS) 29.00
 WIND DIRECTION 45

SAMPLE POSITION (METERS)			CONCENTRATION COEFFICIENT
X	Y	Z	
37.4	28.4	0.0	0.
37.4	14.2	0.0	0.
37.4	0.0	0.0	0.
37.4	-14.2	0.0	0.
37.4	-28.4	0.0	0.
87.0	30.5	0.0	0.
87.0	15.2	0.0	0.
87.0	0.0	0.0	0.
87.0	-15.2	0.0	0.
87.0	-30.5	0.0	0.
187.0	65.0	0.0	0.
187.0	32.5	0.0	0.
187.0	0.0	0.0	0.
187.0	-32.5	0.0	0.
187.0	-65.0	0.0	0.
366.0	64.0	0.0	0.
366.0	32.0	0.0	0.
366.0	0.0	0.0	0.
366.0	-32.0	0.0	0.
366.0	-64.0	0.0	0.
792.0	138.0	0.0	0.
792.0	69.0	0.0	0.
792.0	0.0	0.0	0.
792.0	-69.0	0.0	.32E-02
792.0	-138.0	0.0	.58E-02
1200.0	213.4	0.0	.92E-03
1200.0	106.7	0.0	.46E-02
1200.0	0.0	0.0	.28E-02
1200.0	-106.7	0.0	.15E-01
1200.0	-213.4	0.0	.51E-02
1600.0	224.2	0.0	.21E-02
1600.0	112.1	0.0	.23E-03
1600.0	0.0	0.0	.26E-01
1600.0	-112.1	0.0	.32E-01
1600.0	-224.2	0.0	.32E-02
87.0	0.0	17.8	.92E-03
87.0	0.0	39.4	.46E+00
187.0	0.0	17.8	.61E+00
187.0	0.0	39.4	.30E+00
366.0	0.0	17.8	.24E-01
366.0	0.0	39.4	.47E-01
792.0	0.0	30.5	.21E-01
792.0	0.0	50.8	.14E+00
1200.0	0.0	10.8	.33E-01
1200.0	0.0	30.5	.13E+00
1600.0	0.0	31.1	.22E-01
1600.0	0.0	31.1	.67E-01

MAXIMUM VALUE

.61E+00

RUN NUMBER 36
 STABILITY E
 RELEASE HEIGHT (METERS) 0.00
 WIND DIRECTION 90

SAMPLE POSITION (METERS)			CONCENTRATION COEFFICIENT
X	Y	Z	
37.4	28.4	0.0	0.
37.4	14.2	0.0	.60E+01
37.4	0.0	0.0	.29E+01
37.4	-14.2	0.0	.12E+01
37.4	-28.4	0.0	0.
87.0	30.5	0.0	.56E-01
87.0	15.2	0.0	.52E+00
87.0	0.0	0.0	.12E+01
87.0	-15.2	0.0	.29E+00
87.0	-30.5	0.0	.74E-01
187.0	65.0	0.0	.57E-03
187.0	32.5	0.0	.76E-03
187.0	0.0	0.0	.12E+01
187.0	-32.5	0.0	.86E-02
187.0	-65.0	0.0	0.
366.0	64.0	0.0	0.
366.0	32.0	0.0	.19E-03
366.0	0.0	0.0	.74E-02
366.0	-32.0	0.0	.35E-01
366.0	-64.0	0.0	.55E-01
792.0	138.0	0.0	0.
792.0	69.0	0.0	.25E-02
792.0	0.0	0.0	.85E-01
792.0	-69.0	0.0	.60E-01
792.0	-138.0	0.0	.87E-02
1200.0	213.4	0.0	.42E-02
1200.0	106.7	0.0	.57E-01
1200.0	0.0	0.0	.13E+00
1200.0	-106.7	0.0	.65E-01
1200.0	-213.4	0.0	.21E-01
1600.0	224.2	0.0	.12E-01
1600.0	112.1	0.0	.34E-02
1600.0	0.0	0.0	.23E-01
1600.0	-112.1	0.0	.21E-01
1600.0	-224.2	0.0	.48E-02
87.0	0.0	17.8	.15E+00
87.0	0.0	39.4	.18E-01
187.0	0.0	17.8	.62E+00
187.0	0.0	39.4	.47E-01
366.0	0.0	17.8	.12E+00
366.0	0.0	39.4	.36E-01
792.0	0.0	30.5	.14E+00
792.0	0.0	50.8	.10E-01
1200.0	0.0	10.8	.92E-01
1200.0	0.0	30.5	.72E-02
1600.0	0.0	31.1	.40E-01

MAXIMUM VALUE

.60E+01

RUN NUMBER 38
 STABILITY E
 RELEASE HEIGHT (METERS) 22.60
 WIND DIRECTION 90

SAMPLE POSITION (METERS)			CONCENTRATION COEFFICIENT
X	Y	Z	
37.4	28.4	0.0	.12E+00
37.4	14.2	0.0	.34E+00
37.4	0.0	0.0	.76E+00
37.4	-14.2	0.0	.52E+00
37.4	-28.4	0.0	0.
87.0	30.5	0.0	.78E-02
87.0	15.2	0.0	.94E-01
87.0	0.0	0.0	.51E+00
87.0	-15.2	0.0	.24E+00
87.0	-30.5	0.0	.43E-01
187.0	65.0	0.0	0.
187.0	32.5	0.0	0.
187.0	0.0	0.0	.95E-01
187.0	-32.5	0.0	.55E-02
187.0	-65.0	0.0	0.
366.0	64.0	0.0	0.
366.0	32.0	0.0	0.
366.0	0.0	0.0	.14E-02
366.0	-32.0	0.0	.19E-01
366.0	-64.0	0.0	.45E-01
792.0	138.0	0.0	0.
792.0	69.0	0.0	0.
792.0	0.0	0.0	.56E-01
792.0	-69.0	0.0	.63E-01
792.0	-138.0	0.0	.11E-01
1200.0	213.4	0.0	.39E-02
1200.0	106.7	0.0	.37E-01
1200.0	0.0	0.0	.14E+00
1200.0	-106.7	0.0	.80E-01
1200.0	-213.4	0.0	.29E-01
1600.0	224.2	0.0	.13E-01
1600.0	112.1	0.0	.25E-02
1600.0	0.0	0.0	.28E-01
1600.0	-112.1	0.0	.25E-01
1600.0	-224.2	0.0	.23E-02
87.0	0.0	17.8	.23E+00
87.0	0.0	39.4	.38E-01
187.0	0.0	17.8	.95E+00
187.0	0.0	39.4	.71E-01
366.0	0.0	17.8	.16E+00
366.0	0.0	39.4	.44E-01
792.0	0.0	30.5	.21E+00
792.0	0.0	50.8	.16E-01
1200.0	0.0	10.8	.14E+00
1200.0	0.0	30.5	.16E-01
1600.0	0.0	31.1	.64E-01

MAXIMUM VALUE

.95E+00

RUN NUMBER 3S
 STABILITY E
 RELEASE HEIGHT (METERS) 29.00
 WIND DIRECTION 90

SAMPLE POSITION (METERS)			CONCENTRATION COEFFICIENT
X	Y	Z	
37.4	28.4	0.0	0.
37.4	14.2	0.0	0.
37.4	0.0	0.0	.32E-02
37.4	-14.2	0.0	.46E-03
37.4	-28.4	0.0	0.
87.0	30.5	0.0	0.
87.0	15.2	0.0	0.
87.0	0.0	0.0	.46E-03
87.0	-15.2	0.0	.23E-03
87.0	-30.5	0.0	0.
187.0	65.0	0.0	0.
187.0	32.5	0.0	0.
187.0	0.0	0.0	.46E-03
187.0	-32.5	0.0	0.
187.0	-65.0	0.0	0.
366.0	64.0	0.0	0.
366.0	32.0	0.0	0.
366.0	0.0	0.0	.23E-03
366.0	-32.0	0.0	.92E-03
366.0	-64.0	0.0	.18E-02
792.0	138.0	0.0	0.
792.0	69.0	0.0	0.
792.0	0.0	0.0	.97E-02
792.0	-69.0	0.0	.39E-02
792.0	-138.0	0.0	.46E-03
1200.0	213.4	0.0	0.
1200.0	106.7	0.0	.60E-02
1200.0	0.0	0.0	.22E-01
1200.0	-106.7	0.0	.60E-02
1200.0	-213.4	0.0	.16E-02
1600.0	224.2	0.0	.23E-02
1600.0	112.1	0.0	.16E-01
1600.0	0.0	0.0	.20E-01
1600.0	-112.1	0.0	.88E-02
1600.0	-224.2	0.0	.35E-02
87.0	0.0	17.8	.11E+01
87.0	0.0	39.4	.92E+00
187.0	0.0	17.8	.29E+00
187.0	0.0	39.4	.40E+00
366.0	0.0	17.8	.70E-01
366.0	0.0	39.4	.66E-01
792.0	0.0	30.5	.94E-01
792.0	0.0	50.8	.28E-01
1200.0	0.0	10.8	.10E+00
1200.0	0.0	30.5	.14E-01
1600.0	0.0	31.1	.11E+00

MAXIMUM VALUE

.11E+01

RUN NUMBER 46
 STABILITY E
 RELEASE HEIGHT (METERS) 0.00
 WIND DIRECTION 135

SAMPLE POSITION (METERS)			CONCENTRATION COEFFICIENT
X	Y	Z	
37.4	28.4	0.0	.11E+01
37.4	14.2	0.0	.40E+01
37.4	0.0	0.0	.34E+01
37.4	-14.2	0.0	.56E+00
37.4	-28.4	0.0	0.
87.0	30.5	0.0	.22E+00
87.0	15.2	0.0	.56E+00
87.0	0.0	0.0	.96E-01
87.0	-15.2	0.0	.93E-01
87.0	-30.5	0.0	0.
187.0	65.0	0.0	0.
187.0	32.5	0.0	.27E-02
187.0	0.0	0.0	.11E+00
187.0	-32.5	0.0	0.
187.0	-65.0	0.0	0.
366.0	64.0	0.0	0.
366.0	32.0	0.0	0.
366.0	0.0	0.0	.12E-01
366.0	-32.0	0.0	.64E-01
366.0	-64.0	0.0	.42E-01
792.0	138.0	0.0	0.
792.0	69.0	0.0	0.
792.0	0.0	0.0	.53E-01
792.0	-69.0	0.0	.12E-01
792.0	-138.0	0.0	.32E-01
1200.0	213.4	0.0	0.
1200.0	106.7	0.0	.20E-01
1200.0	0.0	0.0	.11E+00
1200.0	-106.7	0.0	.36E-01
1200.0	-213.4	0.0	.16E+01
1600.0	224.2	0.0	.20E-01
1600.0	112.1	0.0	.48E-01
1600.0	0.0	0.0	.53E-01
1600.0	-112.1	0.0	.42E-01
1600.0	-224.2	0.0	.18E-01
87.0	0.0	17.8	.87E-01
87.0	0.0	39.4	.92E-01
187.0	0.0	17.8	.63E+00
187.0	0.0	39.4	.44E-01
366.0	0.0	17.8	.13E+00
366.0	0.0	39.4	.15E-01
792.0	0.0	30.5	.24E-01
792.0	0.0	50.8	0.
1200.0	0.0	10.8	.54E-01
1200.0	0.0	30.5	.14E-01
1600.0	0.0	31.1	.67E-01

MAXIMUM VALUE

.40E+01

RUN NUMBER 48
 STABILITY E
 RELEASE HEIGHT (METERS) 22.60
 WIND DIRECTION 135

SAMPLE POSITION (METERS)			CONCENTRATION COEFFICIENT
X	Y	Z	
37.4	28.4	0.0	.92E-02
37.4	14.2	0.0	.34E-01
37.4	0.0	0.0	.31E-01
37.4	-14.2	0.0	.92E-03
37.4	-28.4	0.0	0.
87.0	30.5	0.0	.39E-02
87.0	15.2	0.0	.56E-01
87.0	0.0	0.0	.62E-01
87.0	-15.2	0.0	0.
87.0	-30.5	0.0	0.
187.0	65.0	0.0	0.
187.0	32.5	0.0	0.
187.0	0.0	0.0	.14E-01
187.0	-32.5	0.0	0.
187.0	-65.0	0.0	0.
366.0	64.0	0.0	0.
366.0	32.0	0.0	0.
366.0	0.0	0.0	0.
366.0	-32.0	0.0	.15E-01
366.0	-64.0	0.0	.88E-02
792.0	136.0	0.0	0.
792.0	69.0	0.0	0.
792.0	0.0	0.0	.15E-01
792.0	-69.0	0.0	.45E-01
792.0	-138.0	0.0	.11E-01
1200.0	213.4	0.0	0.
1200.0	106.7	0.0	.15E-01
1200.0	0.0	0.0	.64E-01
1200.0	-106.7	0.0	.25E-01
1200.0	-213.4	0.0	.94E-02
1600.0	224.2	0.0	.71E-02
1600.0	112.1	0.0	.27E-01
1600.0	0.0	0.0	.32E-01
1600.0	-112.1	0.0	.22E-01
1600.0	-224.2	0.0	.90E-02
87.0	0.0	17.8	.11E+00
87.0	0.0	39.4	.92E-01
187.0	0.0	17.8	.85E+00
187.0	0.0	39.4	.93E-01
366.0	0.0	17.8	.11E+00
366.0	0.0	39.4	.16E-01
792.0	0.0	30.5	.56E-01
792.0	0.0	50.8	0.
1200.0	0.0	10.8	.58E-01
1200.0	0.0	30.5	.51E-02
1600.0	0.0	31.1	.86E-01

MAXIMUM VALUE

.86E+00

RUN NUMBER 4S
 STABILITY E
 RELEASE HEIGHT (METERS) 29.00
 WIND DIRECTION 135

SAMPLE POSITION (METERS)			CONCENTRATION COEFFICIENT
X	Y	Z	
37.4	28.4	0.0	0.
37.4	14.2	0.0	0.
37.4	0.0	0.0	0.
37.4	-14.2	0.0	0.
37.4	-28.4	0.0	0.
87.0	30.5	0.0	0.
87.0	15.2	0.0	0.
87.0	0.0	0.0	0.
87.0	-15.2	0.0	0.
87.0	-30.5	0.0	0.
187.0	65.0	0.0	0.
187.0	32.5	0.0	0.
187.0	0.0	0.0	0.
187.0	-32.5	0.0	0.
187.0	-65.0	0.0	0.
366.0	64.0	0.0	0.
366.0	32.0	0.0	0.
366.0	0.0	0.0	0.
366.0	-32.0	0.0	0.
366.0	-64.0	0.0	0.
792.0	138.0	0.0	0.
792.0	69.0	0.0	0.
792.0	0.0	0.0	.44E-02
792.0	-69.0	0.0	.10E-01
792.0	-138.0	0.0	.92E-03
1200.0	213.4	0.0	0.
1200.0	106.7	0.0	0.
1200.0	0.0	0.0	.31E-01
1200.0	-106.7	0.0	.12E-01
1200.0	-213.4	0.0	.69E-03
1600.0	224.2	0.0	0.
1600.0	112.1	0.0	.13E-01
1600.0	0.0	0.0	.17E-01
1600.0	-112.1	0.0	.81E-02
1600.0	-224.2	0.0	0.
87.0	0.0	17.8	0.
87.0	0.0	39.4	.22E+00
187.0	0.0	17.8	.28E+00
187.0	0.0	39.4	.12E+00
366.0	0.0	17.8	.27E-01
366.0	0.0	39.4	.17E-01
792.0	0.0	30.5	.34E-01
792.0	0.0	50.8	.53E-02
1200.0	0.0	10.8	.75E-01
1200.0	0.0	30.5	.14E-01
1600.0	0.0	31.1	.76E-01

MAXIMUM VALUE

.28E+00

RUN NUMBER 56
 STABILITY E
 RELEASE HEIGHT (METERS) 0.30
 WIND DIRECTION 180

SAMPLE POSITION (METERS)			CONCENTRATION COEFFICIENT
X	Y	Z	
37.4	28.4	0.0	.32E-01
37.4	14.2	0.0	.82E+00
37.4	0.0	0.0	.42E+01
37.4	-14.2	0.0	.27E+01
37.4	-28.4	0.0	.15E+01
87.0	30.5	0.0	.77E+00
87.0	15.2	0.0	.14E+01
87.0	0.0	0.0	.15E+01
87.0	-15.2	0.0	.51E+00
87.0	-30.5	0.0	.27E-01
187.0	65.0	0.0	.38E-02
187.0	32.5	0.0	.25E-01
187.0	0.0	0.0	.15E+00
187.0	-32.5	0.0	.20E-01
187.0	-65.0	0.0	0.
366.0	64.0	0.0	0.
366.0	32.0	0.0	.10E-01
366.0	0.0	0.0	.35E-01
366.0	-32.0	0.0	.96E-01
366.0	-64.0	0.0	.40E-01
792.0	138.0	0.0	0.
792.0	69.0	0.0	.70E-02
792.0	0.0	0.0	.67E-01
792.0	-69.0	0.0	.52E-01
792.0	-138.0	0.0	.52E-01
1200.0	213.4	0.0	.55E-02
1200.0	106.7	0.0	.44E-01
1200.0	0.0	0.0	.13E+00
1200.0	-106.7	0.0	.11E+00
1200.0	-213.4	0.0	.44E-01
1600.0	224.2	0.0	.86E-02
1600.0	112.1	0.0	.64E-01
1600.0	0.0	0.0	.71E-01
1600.0	-112.1	0.0	.57E-01
1600.0	-224.2	0.0	0.
87.0	0.0	17.8	.50E-01
87.0	0.0	39.4	.29E-02
187.0	0.0	17.8	.45E+00
187.0	0.0	39.4	0.
366.0	0.0	17.8	.10E+00
366.0	0.0	39.4	.14E-01
792.0	0.0	30.5	.30E-01
792.0	0.0	50.8	0.
1200.0	0.0	10.8	.53E-01
1200.0	0.0	30.5	.36E-02
1600.0	0.0	31.1	.69E-01

MAXIMUM VALUE

.42E+01

RUN NUMBER 58
 STABILITY E
 RELEASE HEIGHT (METERS) 22.60
 WIND DIRECTION 180

SAMPLE POSITION (METERS)			CONCENTRATION COEFFICIENT
X	Y	Z	
37.4	28.4	0.0	.90E-02
37.4	14.2	0.0	.32E+01
37.4	0.0	0.0	.90E+00
37.4	-14.2	0.0	.70E+00
37.4	-28.4	0.0	.34E-01
87.0	30.5	0.0	.59E+00
87.0	15.2	0.0	.13E+01
87.0	0.0	0.0	.65E+00
87.0	-15.2	0.0	.11E+00
87.0	-30.5	0.0	0.
187.0	65.0	0.0	0.
187.0	32.5	0.0	.14E-01
187.0	0.0	0.0	.75E-01
187.0	-32.5	0.0	0.
187.0	-65.0	0.0	0.
366.0	64.0	0.0	0.
366.0	32.0	0.0	.32E-02
366.0	0.0	0.0	.21E-01
366.0	-32.0	0.0	.63E-01
366.0	-64.0	0.0	.27E-01
792.0	138.0	0.0	0.
792.0	69.0	0.0	.12E-02
792.0	0.0	0.0	.49E-01
792.0	-69.0	0.0	.40E-01
792.0	-138.0	0.0	.36E-01
1200.0	213.4	0.0	.28E-02
1200.0	106.7	0.0	.38E-01
1200.0	0.0	0.0	.10E+00
1200.0	-106.7	0.0	.83E-01
1200.0	-213.4	0.0	.32E-01
1600.0	224.2	0.0	.80E-02
1600.0	112.1	0.0	.59E-01
1600.0	0.0	0.0	.63E-01
1600.0	-112.1	0.0	.54E-01
1600.0	-224.2	0.0	0.
87.0	0.0	17.8	.14E+00
87.0	0.0	39.4	.63E-01
187.0	0.0	17.8	.52E+00
187.0	0.0	39.4	.44E-02
366.0	0.0	17.8	.70E-01
366.0	0.0	39.4	.12E-02
792.0	0.0	30.5	.34E-01
792.0	0.0	50.8	0.
1200.0	0.0	10.8	.52E-01
1200.0	0.0	30.5	0.
1600.0	0.0	31.1	.69E-01

MAXIMUM VALUE

.13E+01

RUN NUMBER 55
 STABILITY F
 RELEASE HEIGHT (METERS) 29.00
 WIND DIRECTION 180

SAMPLE POSITION (METERS)			CONCENTRATION COEFFICIENT
X	Y	Z	
37.4	28.4	0.0	0.
37.4	14.2	0.0	.46E-03
37.4	0.0	0.0	.23E-03
37.4	-14.2	0.0	0.
37.4	-28.4	0.0	0.
87.0	30.5	0.0	.23E-02
87.0	15.2	0.0	.28E-01
87.0	0.0	0.0	.27E-01
87.0	-15.2	0.0	0.
87.0	-30.5	0.0	0.
187.0	65.0	0.0	0.
187.0	32.5	0.0	0.
187.0	0.0	0.0	.16E-02
187.0	-32.5	0.0	0.
187.0	-65.0	0.0	0.
366.0	64.0	0.0	0.
366.0	32.0	0.0	0.
366.0	0.0	0.0	.65E-02
366.0	-32.0	0.0	.69E-02
366.0	-64.0	0.0	.23E-03
792.0	138.0	0.0	0.
792.0	69.0	0.0	0.
792.0	0.0	0.0	.10E-01
792.0	-69.0	0.0	.18E-01
792.0	-138.0	0.0	.17E-01
1200.0	213.4	0.0	0.
1200.0	106.7	0.0	.51E-02
1200.0	0.0	0.0	.35E-01
1200.0	-106.7	0.0	.21E-01
1200.0	-213.4	0.0	.39E-02
1600.0	224.2	0.0	0.
1600.0	112.1	0.0	.21E-01
1600.0	0.0	0.0	.27E-01
1600.0	-112.1	0.0	.97E-02
1600.0	-224.2	0.0	0.
87.0	0.0	17.8	.72E+00
87.0	0.0	39.4	.14E-02
187.0	0.0	17.8	.57E+00
187.0	0.0	39.4	.11E+00
366.0	0.0	17.8	.53E-01
366.0	0.0	39.4	.21E-02
792.0	0.0	30.5	.12E+00
792.0	0.0	50.8	.17E-01
1200.0	0.0	10.8	.10E+00
1200.0	0.0	30.5	.44E-01
1600.0	0.0	31.1	.60E-01

MAXIMUM VALUE

.72E+00

RUN NUMBER 66
 STABILITY E
 RELEASE HEIGHT (METERS) 0.00
 WIND DIRECTION 225

SAMPLE POSITION (METERS)			CONCENTRATION COEFFICIENT
X	Y	Z	
37.4	28.4	0.0	.31E+00
37.4	14.2	0.0	.44E+01
37.4	0.0	0.0	.17E+02
37.4	-14.2	0.0	.25E+02
37.4	-28.4	0.0	.38E+00
87.0	30.5	0.0	.28E+00
87.0	15.2	0.0	.23E+01
87.0	0.0	0.0	.14E+01
87.0	-15.2	0.0	.69E+00
87.0	-30.5	0.0	.69E+00
187.0	65.0	0.0	0.
187.0	32.5	0.0	.10E-01
187.0	0.0	0.0	.30E+00
187.0	-32.5	0.0	.12E+00
187.0	-65.0	0.0	0.
366.0	64.0	0.0	0.
366.0	32.0	0.0	.21E-01
366.0	0.0	0.0	.63E-01
366.0	-32.0	0.0	.15E+00
366.0	-64.0	0.0	.14E+00
792.0	138.0	0.0	0.
792.0	69.0	0.0	.77E-02
792.0	0.0	0.0	.72E-01
792.0	-69.0	0.0	.14E+00
792.0	-138.0	0.0	.12E+00
1200.0	213.4	0.0	.20E-02
1200.0	106.7	0.0	.40E-01
1200.0	0.0	0.0	.17E+00
1200.0	-106.7	0.0	.21E+00
1200.0	-213.4	0.0	.11E+00
1600.0	224.2	0.0	.17E-01
1600.0	112.1	0.0	.94E-01
1600.0	0.0	0.0	.11E+00
1600.0	-112.1	0.0	.45E-01
1600.0	-224.2	0.0	.20E-02
87.0	0.0	17.8	.14E+00
87.0	0.0	39.4	.24E-01
187.0	0.0	17.8	.70E+00
187.0	0.0	39.4	.31E-01
366.0	0.0	17.8	.15E+00
366.0	0.0	39.4	.57E-02
792.0	0.0	30.5	.11E+00
792.0	0.0	50.8	.68E-02
1200.0	0.0	10.8	.74E-01
1200.0	0.0	30.5	.66E-02
1600.0	0.0	31.1	.73E-01

MAXIMUM VALUE

.25E+02

RUN NUMBER 68
 STABILITY E
 RELEASE HEIGHT (METERS) 22.60
 WIND DIRECTION 225

SAMPLE POSITION (METERS)			CONCENTRATION COEFFICIENT
X	Y	Z	
37.4	28.4	0.0	.80E-03
37.4	14.2	0.0	.16E-01
37.4	0.0	0.0	.21E-01
37.4	-14.2	0.0	0.
37.4	-28.4	0.0	0.
87.0	30.5	0.0	0.
87.0	15.2	0.0	.24E-01
87.0	0.0	0.0	.36E-01
87.0	-15.2	0.0	.16E-02
87.0	-30.5	0.0	.21E-02
187.0	65.0	0.0	0.
187.0	32.5	0.0	0.
187.0	0.0	0.0	.12E-01
187.0	-32.5	0.0	0.
187.0	-65.0	0.0	0.
366.0	64.0	0.0	0.
366.0	32.0	0.0	0.
366.0	0.0	0.0	.27E-03
366.0	-32.0	0.0	.72E-02
366.0	-64.0	0.0	.59E-02
792.0	138.0	0.0	0.
792.0	69.0	0.0	0.
792.0	0.0	0.0	.21E-02
792.0	-69.0	0.0	.24E-01
792.0	-138.0	0.0	.10E-01
1200.0	213.4	0.0	0.
1200.0	106.7	0.0	.11E-02
1200.0	0.0	0.0	.39E-01
1200.0	-106.7	0.0	.40E-01
1200.0	-213.4	0.0	.14E-01
1600.0	224.2	0.0	.27E-03
1600.0	112.1	0.0	.22E-01
1600.0	0.0	0.0	.27E-01
1600.0	-112.1	0.0	.11E-01
1600.0	-224.2	0.0	0.
87.0	0.0	17.8	.22E+00
87.0	0.0	39.4	.52E-01
187.0	0.0	17.8	.80E+00
187.0	0.0	39.4	.18E+00
366.0	0.0	17.8	.13E+00
366.0	0.0	39.4	.43E-02
792.0	0.0	30.5	.18E+00
792.0	0.0	50.8	.19E-01
1200.0	0.0	10.8	.15E+00
1200.0	0.0	30.5	.14E-01
1600.0	0.0	31.1	.16E+00

MAXIMUM VALUE

.80E+00

RUN NUMBER 65
 STABILITY F
 RELEASE HEIGHT (METERS) 29.00
 WIND DIRECTION 225

SAMPLE POSITION (METERS)			CONCENTRATION COEFFICIENT
X	Y	Z	
37.4	28.4	0.0	0.
37.4	14.2	0.0	0.
37.4	0.0	0.0	0.
37.4	-14.2	0.0	0.
37.4	-28.4	0.0	0.
87.0	30.5	0.0	0.
87.0	15.2	0.0	0.
87.0	0.0	0.0	0.
87.0	-15.2	0.0	0.
87.0	-30.5	0.0	0.
187.0	65.0	0.0	0.
187.0	32.5	0.0	0.
187.0	0.0	0.0	0.
187.0	-32.5	0.0	0.
187.0	-65.0	0.0	0.
366.0	64.0	0.0	0.
366.0	32.0	0.0	0.
366.0	0.0	0.0	0.
366.0	-32.0	0.0	0.
366.0	-64.0	0.0	0.
792.0	138.0	0.0	0.
792.0	69.0	0.0	0.
792.0	0.0	0.0	0.
792.0	-69.0	0.0	.13E+02
792.0	-138.0	0.0	.27E-03
1200.0	213.4	0.0	0.
1200.0	106.7	0.0	.32E-01
1200.0	0.0	0.0	.13E-01
1200.0	-106.7	0.0	.13E-01
1200.0	-213.4	0.0	0.
1600.0	224.2	0.0	0.
1600.0	112.1	0.0	.14E-01
1600.0	0.0	0.0	.37E-01
1600.0	-112.1	0.0	.32E-01
1600.0	-224.2	0.0	0.
87.0	0.0	17.8	.22E+03
87.0	0.0	39.4	.48E+03
187.0	0.0	17.8	.25E+03
187.0	0.0	39.4	.69E+03
366.0	0.0	17.8	.80E-01
366.0	0.0	39.4	.26E+03
792.0	0.0	30.5	.23E+03
792.0	0.0	50.8	.38E-01
1200.0	0.0	10.8	.13E+03
1200.0	0.0	30.5	.54E-01
1600.0	0.0	31.1	.21E-01

MAXIMUM VALUE

.69E+03

RUN NUMBER 7G
 STABILITY E
 RELEASE HEIGHT (METERS) 0.00
 WIND DIRECTION 270

SAMPLE POSITION (METERS)			CONCENTRATION COEFFICIENT
X	Y	Z	
37.4	28.4	0.0	.16E+01
37.4	14.2	0.0	.25E+01
37.4	0.0	0.0	.58E+01
37.4	-14.2	0.0	.10E+02
37.4	-28.4	0.0	.34E+02
87.0	33.5	0.0	.85E-01
87.0	15.2	0.0	.37E+00
87.0	0.0	0.0	.97E+00
87.0	-15.2	0.0	.44E+00
87.0	-30.5	0.0	.24E+00
187.0	65.0	0.0	.95E-02
187.0	32.5	0.0	.16E-01
187.0	0.0	0.0	.15E+00
187.0	-32.5	0.0	.12E+00
187.0	-65.0	0.0	.71E-01
366.0	64.0	0.0	.42E-02
366.0	32.0	0.0	.95E-02
366.0	0.0	0.0	.26E-01
366.0	-32.0	0.0	.58E-01
366.0	-64.0	0.0	.14E+00
792.0	138.0	0.0	.51E-02
792.0	69.0	0.0	.41E-01
792.0	0.0	0.0	.20E+00
792.0	-69.0	0.0	.12E-01
792.0	-138.0	0.0	.37E-01
1200.0	213.4	0.0	.13E-01
1200.0	106.7	0.0	.13E-01
1200.0	0.0	0.0	.13E+00
1200.0	-106.7	0.0	.19E+00
1200.0	-213.4	0.0	.10E+00
1600.0	224.2	0.0	.46E-01
1600.0	112.1	0.0	.11E+00
1600.0	0.0	0.0	.11E+00
1600.0	-112.1	0.0	.45E-01
1600.0	-224.2	0.0	0.
87.0	0.0	17.8	.88E-01
87.0	0.0	39.4	.20E-01
187.0	0.0	17.8	.66E+00
187.0	0.0	39.4	.52E-01
366.0	0.0	17.8	.16E+00
366.0	0.0	39.4	.18E-01
792.0	0.0	30.5	.44E+00
792.0	0.0	50.8	.14E-01
1200.0	0.0	10.8	.13E+00
1200.0	0.0	30.5	.29E-01
1600.0	0.0	31.1	.84E-01

MAXIMUM VALUE

.34E+02

RUN NUMBER 79
 STABILITY E
 RELEASE HEIGHT (METERS) 22.60
 WIND DIRECTION 270

SAMPLE POSITION (METERS)			CONCENTRATION COEFFICIENT
X	Y	Z	
37.4	28.4	0.0	.93E-01
37.4	14.2	0.0	.21E+00
37.4	0.0	0.0	.94E-01
37.4	-14.2	0.0	.80E-01
37.4	-28.4	0.0	.75E-01
87.0	30.5	0.0	.48E-01
87.0	15.2	0.0	.19E+00
87.0	0.0	0.0	.12E+01
87.0	-15.2	0.0	.16E+00
87.0	-30.5	0.0	0.
187.0	65.0	0.0	0.
187.0	32.5	0.0	.24E-02
187.0	0.0	0.0	.11E+00
187.0	-32.5	0.0	.39E-01
187.0	-65.0	0.0	0.
366.0	64.0	0.0	0.
366.0	32.0	0.0	0.
366.0	0.0	0.0	.59E-02
366.0	-32.0	0.0	.30E-01
366.0	-64.0	0.0	.95E-01
792.0	138.0	0.0	0.
792.0	69.0	0.0	.13E-01
792.0	0.0	0.0	.19E+00
792.0	-69.0	0.0	.23E-01
792.0	-138.0	0.0	.21E-01
1200.0	213.4	0.0	.43E-02
1200.0	106.7	0.0	.67E-02
1200.0	0.0	0.0	.12E+00
1200.0	-106.7	0.0	.15E+00
1200.0	-213.4	0.0	.56E-01
1600.0	224.2	0.0	.27E-01
1600.0	112.1	0.0	.12E+00
1600.0	0.0	0.0	.12E+00
1600.0	-112.1	0.0	.18E-01
1600.0	-224.2	0.0	0.
87.0	0.0	17.8	.21E+00
87.0	0.0	39.4	.43E-01
187.0	0.0	17.8	.12E+01
187.0	0.0	39.4	.64E-01
366.0	0.0	17.8	.11E+00
366.0	0.0	39.4	.48E-01
792.0	0.0	30.5	.22E+00
792.0	0.0	50.8	.10E-01
1200.0	0.0	10.8	.13E+00
1200.0	0.0	30.5	.30E-01
1600.0	0.0	31.1	.16E+00

MAXIMUM VALUE

.12E+01

RUN NUMBER 75
 STABILITY F
 RELEASE HEIGHT (METERS) 29.00
 WIND DIRECTION 270

SAMPLE POSITION (METERS)			CONCENTRATION COEFFICIENT
X	Y	Z	
37.4	28.4	0.0	0.
37.4	14.2	0.0	0.
37.4	0.0	0.0	0.
37.4	-14.2	0.0	0.
37.4	-28.4	0.0	0.
87.0	30.5	0.0	0.
87.0	15.2	0.0	0.
87.0	0.0	0.0	.75E-02
87.0	-15.2	0.0	.45E-02
87.0	-30.5	0.0	0.
187.0	65.0	0.0	0.
187.0	32.5	0.0	0.
187.0	0.0	0.0	.16E-02
187.0	-32.5	0.0	0.
187.0	-65.0	0.0	0.
366.0	64.0	0.0	0.
366.0	32.0	0.0	0.
366.0	0.0	0.0	0.
366.0	-32.0	0.0	.53E-02
366.0	-64.0	0.0	.83E-02
792.0	138.0	0.0	0.
792.0	69.0	0.0	0.
792.0	0.0	0.0	.28E-01
792.0	-69.0	0.0	.17E-01
792.0	-138.0	0.0	.80E-03
1200.0	213.4	0.0	0.
1200.0	106.7	0.0	.80E-02
1200.0	0.0	0.0	.41E-01
1200.0	-106.7	0.0	.17E-01
1200.0	-213.4	0.0	.64E-02
1600.0	224.2	0.0	0.
1600.0	112.1	0.0	.20E-01
1600.0	0.0	0.0	.21E-01
1600.0	-112.1	0.0	.80E-03
1600.0	-224.2	0.0	0.
87.0	0.0	17.8	.26E+00
87.0	0.0	39.4	.30E+00
187.0	0.0	17.8	0.
187.0	0.0	39.4	.37E+00
366.0	0.0	17.8	.82E-01
366.0	0.0	39.4	.26E+00
792.0	0.0	30.5	.21E+00
792.0	0.0	50.8	.27E-01
1200.0	0.0	10.8	.23E+00
1200.0	0.0	30.5	.34E-01
1600.0	0.0	31.1	.10E+00

MAXIMUM VALUE

.37E+00

RUN NUMBER 06
 STABILITY E
 RELEASE HEIGHT (METERS) 0.00
 WIND DIRECTION 315

SAMPLE POSITION (METERS)			CONCENTRATION COEFFICIENT
X	Y	Z	
37.4	28.4	0.0	.12E+00
37.4	14.2	0.0	.38E+00
37.4	0.0	0.0	.11E+01
37.4	-14.2	0.0	.17E+01
37.4	-28.4	0.0	.18E+01
87.0	30.5	0.0	.17E+00
87.0	15.2	0.0	.39E+00
87.0	0.0	0.0	.14E+01
87.0	-15.2	0.0	.14E+01
87.0	-30.5	0.0	.70E-01
187.0	65.0	0.0	.37E-01
187.0	32.5	0.0	.92E-01
187.0	0.0	0.0	.32E+00
187.0	-32.5	0.0	.49E+00
187.0	-65.0	0.0	.39E+00
366.0	64.0	0.0	.15E+00
366.0	32.0	0.0	.14E+00
366.0	0.0	0.0	.16E+00
366.0	-32.0	0.0	.34E+00
366.0	-64.0	0.0	.55E+00
792.0	138.0	0.0	.12E+00
792.0	69.0	0.0	.22E+00
792.0	0.0	0.0	.71E+00
792.0	-69.0	0.0	.48E+00
792.0	-138.0	0.0	.29E+00
1200.0	213.4	0.0	.16E+00
1200.0	106.7	0.0	.31E+00
1200.0	0.0	0.0	.32E+00
1200.0	-106.7	0.0	.75E+00
1200.0	-213.4	0.0	.76E+00
1600.0	224.2	0.0	.27E+00
1600.0	112.1	0.0	.20E+00
1600.0	0.0	0.0	.23E+00
1600.0	-112.1	0.0	.19E+00
1600.0	-224.2	0.0	0.
87.0	0.0	17.8	.22E+00
87.0	0.0	39.4	.84E-01
187.0	0.0	17.8	.15E+01
187.0	0.0	39.4	.74E-01
366.0	0.0	17.8	.49E+00
366.0	0.0	39.4	.49E+00
792.0	0.0	30.5	.48E+00
792.0	0.0	50.8	.16E-01
1200.0	0.0	10.8	.14E+00
1200.0	0.0	30.5	.32E-01
1600.0	0.0	31.1	.62E-01

MAXIMUM VALUE

.18E+01

RUN NUMBER 88
 STABILITY F
 RELEASE HEIGHT (METERS) 22.60
 WIND DIRECTION 315

SAMPLE POSITION (METERS)			CONCENTRATION COEFFICIENT
X	Y	Z	
37.4	28.4	0.0	.56E-02
37.4	14.2	0.0	0.
37.4	0.0	0.0	.11E-01
37.4	-14.2	0.0	0.
37.4	-28.4	0.0	0.
87.0	30.5	0.0	0.
87.0	15.2	0.0	0.
87.0	0.0	0.0	.14E-01
87.0	-15.2	0.0	.12E-01
87.0	-30.5	0.0	0.
187.0	65.0	0.0	0.
187.0	32.5	0.0	0.
187.0	0.0	0.0	.13E-01
187.0	-32.5	0.0	.13E-01
187.0	-65.0	0.0	0.
366.0	64.0	0.0	0.
366.0	32.0	0.0	0.
366.0	0.0	0.0	.96E-02
366.0	-32.0	0.0	.32E-01
366.0	-64.0	0.0	.31E-01
792.0	138.0	0.0	0.
792.0	69.0	0.0	.11E-01
792.0	0.0	0.0	.16E+00
792.0	-69.0	0.0	.37E-01
792.0	-138.0	0.0	.23E-01
1200.0	213.4	0.0	.64E-02
1200.0	106.7	0.0	.82E-01
1200.0	0.0	0.0	.81E-01
1200.0	-106.7	0.0	.13E+00
1200.0	-213.4	0.0	.11E+00
1600.0	224.2	0.0	.35E-01
1600.0	112.1	0.0	.85E-01
1600.0	0.0	0.0	.12E+00
1600.0	-112.1	0.0	.75E-01
1600.0	-224.2	0.0	0.
87.0	0.0	17.8	.45E+00
87.0	0.0	39.4	.69E+00
187.0	0.0	17.8	.84E+00
187.0	0.0	39.4	.46E+00
366.0	0.0	17.8	.86E-01
366.0	0.0	39.4	.86E-01
792.0	0.0	30.5	.51E+00
792.0	0.0	50.8	.22E-01
1200.0	0.0	10.8	.31E+00
1200.0	0.0	30.5	.67E-01
1600.0	0.0	31.1	.16E+00

MAXIMUM VALUE

.84E+00

RUN NUMBER 85
 STABILITY E
 RELEASE HEIGHT (METERS) 29.00
 WIND DIRECTION 315

SAMPLE POSITION (METERS)			CONCENTRATION COEFFICIENT
X	Y	Z	
37.4	28.4	0.0	0.
37.4	14.2	0.0	0.
37.4	0.0	0.0	0.
37.4	-14.2	0.0	0.
37.4	-28.4	0.0	0.
87.0	30.5	0.0	0.
87.0	15.2	0.0	0.
87.0	0.0	0.0	0.
87.0	-15.2	0.0	0.
87.0	-30.5	0.0	0.
187.0	65.0	0.0	0.
187.0	32.5	0.0	0.
187.0	0.0	0.0	.20E-02
187.0	-32.5	0.0	.32E-02
187.0	-65.0	0.0	0.
366.0	64.0	0.0	0.
366.0	32.0	0.0	0.
366.0	0.0	0.0	.40E-03
366.0	-32.0	0.0	.16E-02
366.0	-64.0	0.0	.52E-02
792.0	138.0	0.0	0.
792.0	69.0	0.0	0.
792.0	0.0	0.0	.30E-01
792.0	-69.0	0.0	.16E-01
792.0	-138.0	0.0	.16E-01
1200.0	213.4	0.0	.40E-02
1200.0	106.7	0.0	.14E-01
1200.0	0.0	0.0	.55E-01
1200.0	-106.7	0.0	.76E-02
1200.0	-213.4	0.0	0.
1600.0	224.2	0.0	0.
1600.0	112.1	0.0	.28E-01
1600.0	0.0	0.0	.29E-01
1600.0	-112.1	0.0	.13E-01
1600.0	-224.2	0.0	.16E-02
87.0	0.0	17.8	.25E+03
87.0	0.0	39.4	0.
187.0	0.0	17.8	.58E+00
187.0	0.0	39.4	.32E-01
366.0	0.0	17.8	.15E+00
366.0	0.0	39.4	.70E-01
792.0	0.0	30.5	.53E+00
792.0	0.0	50.8	.81E-01
1200.0	0.0	17.8	.38E+00
1200.0	0.0	30.5	.69E-01
1600.0	0.0	31.1	.20E+00

MAXIMUM VALUE

.58E+00

RUN NUMBER 96
 STABILITY E
 RELEASE HEIGHT (METERS) 0.00
 WIND DIRECTION 0

SAMPLE POSITION (METERS)			CONCENTRATION COEFFICIENT
X	Y	Z	
37.4	28.4	0.0	0.
37.4	14.2	0.0	.16E+00
37.4	0.0	0.0	.18E+01
37.4	-14.2	0.0	.16E+00
37.4	-28.4	0.0	0.
87.0	30.5	0.0	.33E-01
87.0	15.2	0.0	.49E+00
87.0	0.0	0.0	.65E+00
87.0	-15.2	0.0	.43E-01
87.0	-30.5	0.0	.69E-02
187.0	65.0	0.0	0.
187.0	32.5	0.0	.19E-01
187.0	0.0	0.0	.22E+00
187.0	-32.5	0.0	.38E-01
187.0	-65.0	0.0	.99E-03
366.0	64.0	0.0	0.
366.0	32.0	0.0	.33E-02
366.0	0.0	0.0	.43E-01
366.0	-32.0	0.0	.89E-01
366.0	-64.0	0.0	.58E-01
792.0	138.0	0.0	.15E-01
792.0	69.0	0.0	.82E-02
792.0	0.0	0.0	.87E-01
792.0	-69.0	0.0	.11E+00
792.0	-138.0	0.0	.50E-01
1200.0	213.4	0.0	.49E-02
1200.0	106.7	0.0	.51E-01
1200.0	0.0	0.0	.18E+00
1200.0	-106.7	0.0	.18E+00
1200.0	-213.4	0.0	.90E-01
1600.0	224.2	0.0	.19E-01
1600.0	112.1	0.0	.85E-01
1600.0	0.0	0.0	.95E-01
1600.0	-112.1	0.0	.84E-01
1600.0	-224.2	0.0	.33E-02
87.0	0.0	17.8	0.
87.0	0.0	39.4	0.
187.0	0.0	17.8	.89E-02
187.0	0.0	39.4	.32E+00
366.0	0.0	17.8	.17E+00
366.0	0.0	39.4	.23E+00
792.0	0.0	30.5	.24E+00
792.0	0.0	50.8	.20E+00
1200.0	0.0	10.8	.19E+00
1200.0	0.0	30.5	.42E-01
1600.0	0.0	31.1	.17E+00

MAXIMUM VALUE

.18E+01

RUN NUMBER 98
 STABILITY E
 RELEASE HEIGHT (METERS) 22.60
 WIND DIRECTION 0

SAMPLE POSITION (METERS)			CONCENTRATION COEFFICIENT
X	Y	Z	
37.4	28.4	0.0	0.
37.4	14.2	0.0	0.
37.4	0.0	0.0	0.
37.4	-14.2	0.0	0.
37.4	-28.4	0.0	0.
87.0	30.5	0.0	0.
87.0	15.2	0.0	.44E-02
87.0	0.0	0.0	.36E-02
87.0	-15.2	0.0	.12E-02
87.0	-30.5	0.0	0.
187.0	65.0	0.0	0.
187.0	32.5	0.0	0.
187.0	0.0	0.0	.76E-02
187.0	-32.5	0.0	0.
187.0	-65.0	0.0	0.
366.0	64.0	0.0	0.
366.0	32.0	0.0	.40E-03
366.0	0.0	0.0	.20E-02
366.0	-32.0	0.0	.46E-02
366.0	-64.0	0.0	.36E-02
792.0	138.0	0.0	0.
792.0	69.0	0.0	0.
792.0	0.0	0.0	.10E-01
792.0	-69.0	0.0	.88E-02
792.0	-138.0	0.0	.44E-02
1200.0	213.4	0.0	0.
1200.0	106.7	0.0	.48E-02
1200.0	0.0	0.0	.53E-01
1200.0	-106.7	0.0	.13E-01
1200.0	-213.4	0.0	0.
1600.0	224.2	0.0	.14E-01
1600.0	112.1	0.0	.63E-01
1600.0	0.0	0.0	.77E-01
1600.0	-112.1	0.0	.28E-02
1600.0	-224.2	0.0	.80E-03
87.0	0.0	17.8	.53E-01
87.0	0.0	39.4	.11E+01
187.0	0.0	17.8	.28E+00
187.0	0.0	39.4	.77E+00
366.0	0.0	17.8	.14E+00
366.0	0.0	39.4	.40E+00
792.0	0.0	30.5	.19E+00
792.0	0.0	50.8	.34E-01
1200.0	0.0	10.8	.17E+00
1200.0	0.0	30.5	.37E-01
1600.0	0.0	31.1	.17E+00

MAXIMUM VALUE

.11E+01

RUN NUMBER 95
 STABILITY E
 RELEASE HEIGHT (METERS) 29.00
 WIND DIRECTION 0

SAMPLE POSITION (METERS)			CONCENTRATION COEFFICIENT
X	Y	Z	
37.4	28.4	0.0	0.
37.4	14.2	0.0	0.
37.4	0.0	0.0	0.
37.4	-14.2	0.0	0.
37.4	-28.4	0.0	0.
87.0	30.5	0.0	0.
87.0	15.2	0.0	0.
87.0	0.0	0.0	.40E-03
87.0	-15.2	0.0	0.
87.0	-30.5	0.0	0.
187.0	65.0	0.0	0.
187.0	32.5	0.0	0.
187.0	0.0	0.0	.64E-02
187.0	-32.5	0.0	0.
187.0	-65.0	0.0	0.
366.0	64.0	0.0	0.
366.0	32.0	0.0	0.
366.0	0.0	0.0	.80E-03
366.0	-32.0	0.0	.44E-02
366.0	-64.0	0.0	.20E-02
792.0	138.0	0.0	0.
792.0	69.0	0.0	0.
792.0	0.0	0.0	.32E-02
792.0	-69.0	0.0	.10E-01
792.0	-138.0	0.0	.40E-02
1200.0	213.4	0.0	0.
1200.0	106.7	0.0	.40E-03
1200.0	0.0	0.0	.16E-01
1200.0	-106.7	0.0	.13E-01
1200.0	-213.4	0.0	0.
1600.0	224.2	0.0	.16E-01
1600.0	112.1	0.0	.76E-01
1600.0	0.0	0.0	.96E-01
1600.0	-112.1	0.0	.76E-01
1600.0	-224.2	0.0	0.
87.0	0.0	17.8	.34E-01
87.0	0.0	39.4	.89E+00
187.0	0.0	17.8	.36E+00
187.0	0.0	39.4	.11E+01
366.0	0.0	17.8	.23E+00
366.0	0.0	39.4	.47E+00
792.0	0.0	30.5	.33E+00
792.0	0.0	50.8	.61E-01
1200.0	0.0	10.8	.29E+00
1200.0	0.0	30.5	.65E-01
1600.0	0.0	31.1	.27E+00

MAXIMUM VALUE

.11E+01

TABLE VI. Data, Stable

RUN NUMBER 10
 STABILITY G
 RELEASE HEIGHT (METERS) 0.00
 WIND DIRECTION 0

SAMPLE POSITION (METERS)			CONCENTRATION COEFFICIENT
X	Y	Z	
37.4	28.4	0.0	.35E+01
37.4	14.2	0.0	.55E+01
37.4	0.0	0.0	.80E+00
37.4	-14.2	0.0	.24E+00
37.4	-28.4	0.0	.94E-01
87.0	30.5	0.0	.44E+01
87.0	15.2	0.0	.15E+01
87.0	0.0	0.0	.38E+00
87.0	-15.2	0.0	.11E+00
87.0	-30.5	0.0	.37E+00
187.0	65.0	0.0	.34E+00
187.0	32.5	0.0	.19E+01
187.0	0.0	0.0	.36E+00
187.0	-32.5	0.0	.16E-01
187.0	-65.0	0.0	.24E-01
366.0	64.0	0.0	.74E+00
366.0	32.0	0.0	.11E+01
366.0	0.0	0.0	.27E+00
366.0	-32.0	0.0	.14E+00
366.0	-64.0	0.0	.22E-01
792.0	138.0	0.0	.21E-01
792.0	69.0	0.0	.31E+00
792.0	0.0	0.0	.49E+00
792.0	-69.0	0.0	.21E-02
792.0	-138.0	0.0	.37E-02
1200.0	213.4	0.0	.25E-01
1200.0	106.7	0.0	.28E+00
1200.0	0.0	0.0	.28E+00
1200.0	-106.7	0.0	.38E-01
1200.0	-213.4	0.0	.52E-02
1600.0	224.2	0.0	.13E-01
1600.0	112.1	0.0	.14E+00
1600.0	0.0	0.0	.15E+00
1600.0	-112.1	0.0	.11E+00
1600.0	-224.2	0.0	.32E-01
87.0	0.0	17.8	.29E+00
87.0	0.0	39.4	.49E-01
187.0	0.0	17.8	.24E+00
187.0	0.0	39.4	.32E-01
366.0	0.0	17.8	.54E-01
366.0	0.0	39.4	.29E-01
792.0	0.0	30.5	.13E+00
792.0	0.0	50.8	.27E-01
1200.0	0.0	10.8	.16E+00
1200.0	0.0	30.5	.84E-02
1600.0	0.0	31.1	.15E+00

MAXIMUM VALUE

.55E+01

RUN NUMBER 18
 STABILITY G
 RELEASE HEIGHT (METERS) 22.60
 WIND DIRECTION 0

SAMPLE POSITION (METERS)			CONCENTRATION COEFFICIENT
X	Y	Z	
37.4	28.4	0.0	.19E+00
37.4	14.2	0.0	.18E+01
37.4	0.0	0.0	.29E+01
37.4	-14.2	0.0	.90E+00
37.4	-28.4	0.0	.27E+00
87.0	30.5	0.0	.56E+00
87.0	15.2	0.0	.26E+01
87.0	0.0	0.0	.16E+01
87.0	-15.2	0.0	.45E+00
87.0	-30.5	0.0	.20E-01
187.0	65.0	0.0	.26E-01
187.0	32.5	0.0	.75E+00
187.0	0.0	0.0	.12E+01
187.0	-32.5	0.0	.15E-01
187.0	-65.0	0.0	.36E-01
366.0	64.0	0.0	.16E+00
366.0	32.0	0.0	.74E+00
366.0	0.0	0.0	.45E+00
366.0	-32.0	0.0	.18E+00
366.0	-64.0	0.0	.76E-01
792.0	138.0	0.0	.10E-01
792.0	69.0	0.0	.83E-01
792.0	0.0	0.0	.63E+00
792.0	-69.0	0.0	.25E-02
792.0	-138.0	0.0	.38E-02
1200.0	213.4	0.0	.70E-02
1200.0	106.7	0.0	.10E+00
1200.0	0.0	0.0	.28E+00
1200.0	-106.7	0.0	.83E-01
1200.0	-213.4	0.0	.70E-02
1600.0	224.2	0.0	.76E-02
1600.0	112.1	0.0	.69E-01
1600.0	0.0	0.0	.12E+00
1600.0	-112.1	0.0	.60E-01
1600.0	-224.2	0.0	.25E-01
87.0	0.0	17.8	.13E+01
87.0	0.0	39.4	.13E+01
187.0	0.0	17.8	.73E+00
187.0	0.0	39.4	.49E-01
366.0	0.0	17.8	.18E+00
366.0	0.0	39.4	.35E-01
792.0	0.0	30.5	.18E+00
792.0	0.0	50.8	.37E-01
1200.0	0.0	10.8	.19E+00
1200.0	0.0	30.5	.89E-02
1600.0	0.0	31.1	.18E+00

MAXIMUM VALUE

.29E+01

RUN NUMBER 1S
 STABILITY G
 RELEASE HEIGHT (METERS) 29.00
 WIND DIRECTION 0

SAMPLE POSITION (METERS)			CONCENTRATION COEFFICIENT
X	Y	Z	
37.4	28.4	0.0	.90E-01
37.4	14.2	0.0	.24E+00
37.4	0.0	0.0	.33E+00
37.4	-14.2	0.0	.17E+00
37.4	-28.4	0.0	.28E-01
87.0	30.5	0.0	.82E-01
87.0	15.2	0.0	.69E+00
87.0	0.0	0.0	.44E+00
87.0	-15.2	0.0	.11E+00
87.0	-30.5	0.0	.63E-02
187.0	65.0	0.0	.95E-02
187.0	32.5	0.0	.34E+00
187.0	0.0	0.0	.11E+01
187.0	-32.5	0.0	.19E+00
187.0	-65.0	0.0	.57E-02
366.0	64.0	0.0	.38E-01
366.0	32.0	0.0	.39E+00
366.0	0.0	0.0	.11E+01
366.0	-32.0	0.0	.32E+00
366.0	-64.0	0.0	.58E-01
792.0	138.0	0.0	.38E-02
792.0	69.0	0.0	.37E-01
792.0	0.0	0.0	.56E+00
792.0	-69.0	0.0	.13E-01
792.0	-138.0	0.0	.13E-02
1200.0	213.4	0.0	.19E-02
1200.0	106.7	0.0	.20E-01
1200.0	0.0	0.0	.63E-01
1200.0	-106.7	0.0	.37E-01
1200.0	-213.4	0.0	.19E-01
1600.0	224.2	0.0	.51E-02
1600.0	112.1	0.0	.11E+00
1600.0	0.0	0.0	.12E+00
1600.0	-112.1	0.0	.70E-01
1600.0	-224.2	0.0	.20E-01
87.0	0.0	17.8	.11E+01
87.0	0.0	39.4	.13E+01
187.0	0.0	17.8	.10E+01
187.0	0.0	39.4	.66E-01
366.0	0.0	17.8	.49E+00
366.0	0.0	39.4	.58E-01
792.0	0.0	30.5	.19E+00
792.0	0.0	50.8	.42E-01
1200.0	0.0	10.8	.22E+00
1200.0	0.0	30.5	.39E-01
1600.0	0.0	31.1	.17E+00

MAXIMUM VALUE

.13E+01

RUN NUMBER 26
 STABILITY G
 RELEASE HEIGHT (METERS) 0.00
 WIND DIRECTION 45

SAMPLE POSITION (METERS)			CONCENTRATION COEFFICIENT
X	Y	Z	
37.4	28.4	0.0	.16E+00
37.4	14.2	0.0	.22E+01
37.4	0.0	0.0	.23E+01
37.4	-14.2	0.0	.55E-01
37.4	-28.4	0.0	.12E-01
87.0	30.5	0.0	.37E-02
87.0	15.2	0.0	.18E+01
87.0	0.0	0.0	.15E+01
87.0	-15.2	0.0	.35E+00
87.0	-30.5	0.0	.23E-01
187.0	65.0	0.0	.20E-01
187.0	32.5	0.0	.39E+00
187.0	0.0	0.0	.11E+01
187.0	-32.5	0.0	.19E+00
187.0	-65.0	0.0	.94E-02
366.0	64.0	0.0	.44E-01
366.0	32.0	0.0	.23E+00
366.0	0.0	0.0	.50E+00
366.0	-32.0	0.0	.31E+00
366.0	-64.0	0.0	.51E-01
792.0	138.0	0.0	.12E-01
792.0	69.0	0.0	.21E-01
792.0	0.0	0.0	.62E+00
792.0	-69.0	0.0	.12E-01
792.0	-138.0	0.0	.31E-02
1200.0	213.4	0.0	.10E-02
1200.0	106.7	0.0	.10E-02
1200.0	0.0	0.0	.68E-01
1200.0	-106.7	0.0	.15E+00
1200.0	-213.4	0.0	.11E+00
1600.0	224.2	0.0	.12E-01
1600.0	112.1	0.0	.64E-01
1600.0	0.0	0.0	.15E+00
1600.0	-112.1	0.0	.14E+00
1600.0	-224.2	0.0	.89E-02
87.0	0.0	17.8	.13E+01
87.0	0.0	39.4	.52E+00
187.0	0.0	17.8	.10E+01
187.0	0.0	39.4	.29E+00
366.0	0.0	17.8	.14E+00
366.0	0.0	39.4	.49E-01
792.0	0.0	30.5	.24E+00
792.0	0.0	50.8	.47E-01
1200.0	0.0	10.8	0.
1200.0	0.0	30.5	.18E-01
1600.0	0.0	31.1	.19E+00

MAXIMUM VALUE

.23E+01

RUN NUMBER 28
 STABILITY G
 RELEASE HEIGHT (METERS) 22.60
 WIND DIRECTION 45

SAMPLE POSITION (METERS)			CONCENTRATION COEFFICIENT
X	Y	Z	
37.4	28.4	0.0	.37E-01
37.4	14.2	0.0	.16E-01
37.4	0.0	0.0	.22E+00
37.4	-14.2	0.0	.19E-01
37.4	-28.4	0.0	.82E-02
87.0	30.5	0.0	.25E-02
87.0	15.2	0.0	.16E+00
87.0	0.0	0.0	.30E+00
87.0	-15.2	0.0	.12E+00
87.0	-30.5	0.0	.11E-01
187.0	65.0	0.0	.51E-02
187.0	32.5	0.0	.55E-01
187.0	0.0	0.0	.54E+00
187.0	-32.5	0.0	.98E-01
187.0	-65.0	0.0	.70E-02
366.0	64.0	0.0	.89E-02
366.0	32.0	0.0	.58E-01
366.0	0.0	0.0	.30E+00
366.0	-32.0	0.0	.24E+00
366.0	-64.0	0.0	.29E-01
792.0	138.0	0.0	.57E-02
792.0	69.0	0.0	.89E-02
792.0	0.0	0.0	.41E+00
792.0	-69.0	0.0	.79E-01
792.0	-138.0	0.0	.44E-02
1200.0	213.4	0.0	.19E-02
1200.0	106.7	0.0	.44E-02
1200.0	0.0	0.0	.32E-01
1200.0	-106.7	0.0	.11E+00
1200.0	-213.4	0.0	.91E-01
1600.0	224.2	0.0	.13E-01
1600.0	112.1	0.0	.42E-01
1600.0	0.0	0.0	.60E-01
1600.0	-112.1	0.0	.56E-01
1600.0	-224.2	0.0	.38E-02
87.0	0.0	17.8	.12E+01
87.0	0.0	39.4	.13E+01
187.0	0.0	17.8	.11E+01
187.0	0.0	39.4	.32E+00
366.0	0.0	17.8	.17E+00
366.0	0.0	39.4	.60E-01
792.0	0.0	30.5	.28E+00
792.0	0.0	50.8	.68E-01
1200.0	0.0	10.8	0.
1200.0	0.0	30.5	.23E-01
1600.0	0.0	31.1	.19E+00

MAXIMUM VALUE

.13E+01

RUN NUMBER 25
 STABILITY G
 RELEASE HEIGHT (METERS) 29.00
 WIND DIRECTION 45

SAMPLE POSITION (METERS)			CONCENTRATION COEFFICIENT
X	Y	Z	
37.4	28.4	0.0	.95E-02
37.4	14.2	0.0	.13E-01
37.4	0.0	0.0	.27E-01
37.4	-14.2	0.0	.95E-02
37.4	-28.4	0.0	.63E-02
87.0	30.5	0.0	.13E-01
87.0	15.2	0.0	.24E-01
87.0	0.0	0.0	.67E-01
87.0	-15.2	0.0	.30E-01
87.0	-30.5	0.0	.70E-01
187.0	65.0	0.0	.38E-02
187.0	32.5	0.0	.16E-01
187.0	0.0	0.0	.24E+00
187.0	-32.5	0.0	.45E-01
187.0	-65.0	0.0	.82E-02
366.0	64.0	0.0	.63E-02
366.0	32.0	0.0	.16E-01
366.0	0.0	0.0	.15E+00
366.0	-32.0	0.0	.49E-01
366.0	-64.0	0.0	.20E-01
792.0	138.0	0.0	.38E-02
792.0	69.0	0.0	.57E-02
792.0	0.0	0.0	.53E-01
792.0	-69.0	0.0	.19E-02
792.0	-138.0	0.0	.13E-02
1200.0	213.4	0.0	.57E-02
1200.0	106.7	0.0	.20E-01
1200.0	0.0	0.0	.19E+00
1200.0	-106.7	0.0	.83E-01
1200.0	-213.4	0.0	.48E-01
1600.0	224.2	0.0	.42E-01
1600.0	112.1	0.0	.44E-01
1600.0	0.0	0.0	.54E-01
1600.0	-112.1	0.0	.39E-01
1600.0	-224.2	0.0	.10E-01
87.0	0.0	17.8	.51E-02
87.0	0.0	39.4	.13E+01
187.0	0.0	17.8	.86E+00
187.0	0.0	39.4	.35E+00
366.0	0.0	17.8	.31E+00
366.0	0.0	39.4	.79E-01
792.0	0.0	30.5	.32E+00
792.0	0.0	50.8	.79E-01
1200.0	0.0	10.8	.26E+00
1200.0	0.0	30.5	.41E-01
1600.0	0.0	31.1	.23E+00

MAXIMUM VALUE

.13E+01

RUN NUMBER 36
 STABILITY G
 RELEASE HEIGHT (METERS) 0.00
 WIND DIRECTION 90

SAMPLE POSITION (METERS)			CONCENTRATION COEFFICIENT
X	Y	Z	
37.4	28.4	0.0	.15E+01
37.4	14.2	0.0	.43E+01
37.4	0.0	0.0	.34E+01
37.4	-14.2	0.0	.12E+01
37.4	-28.4	0.0	.61E-01
87.0	30.5	0.0	.19E+00
87.0	15.2	0.0	.14E+01
87.0	0.0	0.0	.15E+01
87.0	-15.2	0.0	.79E+00
87.0	-30.5	0.0	.18E+00
187.0	65.0	0.0	.20E-01
187.0	32.5	0.0	.40E+00
187.0	0.0	0.0	.10E+01
187.0	-32.5	0.0	.35E+00
187.0	-65.0	0.0	.29E-01
366.0	64.0	0.0	.37E-01
366.0	32.0	0.0	.12E+00
366.0	0.0	0.0	.35E+00
366.0	-32.0	0.0	.17E+00
366.0	-64.0	0.0	.68E-02
792.0	138.0	0.0	.63E-02
792.0	69.0	0.0	.94E-02
792.0	0.0	0.0	.45E+00
792.0	-69.0	0.0	.28E-01
792.0	-138.0	0.0	.31E-02
1200.0	213.4	0.0	.10E-02
1200.0	106.7	0.0	.67E-01
1200.0	0.0	0.0	.22E+00
1200.0	-106.7	0.0	.74E-01
1200.0	-213.4	0.0	.89E-02
1600.0	224.2	0.0	.12E-01
1600.0	112.1	0.0	.80E-01
1600.0	0.0	0.0	.15E+00
1600.0	-112.1	0.0	.11E+00
1600.0	-224.2	0.0	.12E-01
87.0	0.0	17.8	.25E+00
87.0	0.0	39.4	.48E-01
187.0	0.0	17.8	.76E+00
187.0	0.0	39.4	.69E-01
366.0	0.0	17.8	.21E+00
366.0	0.0	39.4	.38E-01
792.0	0.0	30.5	.21E+00
792.0	0.0	50.8	.39E-01
1200.0	0.0	10.8	.23E+00
1200.0	0.0	30.5	.23E+00
1600.0	0.0	31.1	.18E+00

MAXIMUM VALUE

.43E+01

RUN NUMBER 38
 STABILITY G
 RELEASE HEIGHT (METERS) 22.60
 WIND DIRECTION 90

SAMPLE POSITION (METERS)			CONCENTRATION COEFFICIENT
X	Y	Z	
37.4	28.4	0.0	.13E+00
37.4	14.2	0.0	.59E+00
37.4	0.0	0.0	.20E+01
37.4	-14.2	0.0	.14E+01
37.4	-28.4	0.0	.56E-01
87.0	30.5	0.0	.76E-01
87.0	15.2	0.0	.88E+00
87.0	0.0	0.0	.23E+01
87.0	-15.2	0.0	.12E+01
87.0	-30.5	0.0	.21E+00
187.0	65.0	0.0	.14E-01
187.0	32.5	0.0	.18E+00
187.0	0.0	0.0	.12E+01
187.0	-32.5	0.0	.54E+00
187.0	-65.0	0.0	.46E-01
366.0	64.0	0.0	.18E-01
366.0	32.0	0.0	.64E-01
366.0	0.0	0.0	.30E+00
366.0	-32.0	0.0	.27E+01
366.0	-64.0	0.0	.76E-02
792.0	138.0	0.0	.10E-01
792.0	69.0	0.0	.89E-02
792.0	0.0	0.0	.38E+00
792.0	-69.0	0.0	.13E+00
792.0	-138.0	0.0	.63E-02
1200.0	213.4	0.0	.63E-02
1200.0	106.7	0.0	.51E-01
1200.0	0.0	0.0	.20E+01
1200.0	-106.7	0.0	.60E-01
1200.0	-213.4	0.0	.20E-01
1600.0	224.2	0.0	.16E-01
1600.0	112.1	0.0	.73E-01
1600.0	0.0	0.0	.19E+00
1600.0	-112.1	0.0	.15E+00
1600.0	-224.2	0.0	.16E-01
87.0	0.0	17.8	.79E+00
87.0	0.0	39.4	.95E+00
187.0	0.0	17.8	.87E+00
187.0	0.0	39.4	.13E+00
366.0	0.0	17.8	.21E+00
366.0	0.0	39.4	.41E-01
792.0	0.0	30.5	.23E+00
792.0	0.0	50.8	.51E-01
1200.0	0.0	10.8	.22E+00
1200.0	0.0	30.5	.22E+00
1600.0	0.0	31.1	.18E+00

MAXIMUM VALUE

.23E+01

RUN NUMBER 35
 STABILITY G
 RELEASE HEIGHT (METERS) 29.00
 WIND DIRECTION 90

SAMPLE POSITION (METERS)			CONCENTRATION COEFFICIENT
X	Y	Z	
37.4	28.4	0.0	.11E-01
37.4	14.2	0.0	.16E-01
37.4	0.0	0.0	.88E-01
37.4	-14.2	0.0	.63E-01
37.4	-28.4	0.0	.12E-01
87.0	30.5	0.0	.40E-01
87.0	15.2	0.0	.32E+00
87.0	0.0	0.0	.44E+00
87.0	-15.2	0.0	.17E+00
87.0	-30.5	0.0	.24E-01
187.0	65.0	0.0	.10E-01
187.0	32.5	0.0	.15E+00
187.0	0.0	0.0	.11E+01
187.0	-32.5	0.0	.21E+00
187.0	-65.0	0.0	.16E-01
366.0	64.0	0.0	.23E-01
366.0	32.0	0.0	.25E+00
366.0	0.0	0.0	.83E+00
366.0	-32.0	0.0	.18E+00
366.0	-64.0	0.0	.98E-01
792.0	138.0	0.0	.44E-02
792.0	69.0	0.0	.10E-01
792.0	0.0	0.0	.48E+00
792.0	-69.0	0.0	.40E+00
792.0	-138.0	0.0	.88E-01
1200.0	213.4	0.0	.13E-01
1200.0	106.7	0.0	.22E-01
1200.0	0.0	0.0	.28E+00
1200.0	-106.7	0.0	.22E+00
1200.0	-213.4	0.0	.52E-01
1600.0	224.2	0.0	.15E-01
1600.0	112.1	0.0	.68E-01
1600.0	0.0	0.0	.13E+00
1600.0	-112.1	0.0	.93E-01
1600.0	-224.2	0.0	.12E-01
87.0	0.0	17.8	.13E+01
87.0	0.0	39.4	.13E+01
187.0	0.0	17.8	.10E+01
187.0	0.0	39.4	.72E-01
366.0	0.0	17.8	.45E+00
366.0	0.0	39.4	.60E-01
792.0	0.0	30.5	.21E+00
792.0	0.0	50.8	.52E-01
1200.0	0.0	10.8	.21E+00
1200.0	0.0	30.5	.15E+00
1600.0	0.0	31.1	.17E+00

MAXIMUM VALUE

.13E+01

RUN NUMBER 46
 STABILITY 6
 RELEASE HEIGHT (METERS) 0.00
 WIND DIRECTION 135

SAMPLE POSITION (METERS)			CONCENTRATION COEFFICIENT
X	Y	Z	
37.4	28.4	0.0	.75E+00
37.4	14.2	0.0	.32E+01
37.4	0.0	0.0	.32E+01
37.4	-14.2	0.0	.20E+01
37.4	-28.4	0.0	.89E-02
87.0	30.5	0.0	.26E+00
87.0	15.2	0.0	.10E+01
87.0	0.0	0.0	.15E+01
87.0	-15.2	0.0	.85E+00
87.0	-30.5	0.0	.85E-01
187.0	65.0	0.0	.20E-01
187.0	32.5	0.0	.32E+00
187.0	0.0	0.0	.97E+00
187.0	-32.5	0.0	.37E+00
187.0	-65.0	0.0	.20E-01
366.0	64.0	0.0	.52E-01
366.0	32.0	0.0	.28E+00
366.0	0.0	0.0	.33E+00
366.0	-32.0	0.0	.26E+00
366.0	-64.0	0.0	.14E+00
792.0	138.0	0.0	.14E-01
792.0	69.0	0.0	.27E-01
792.0	0.0	0.0	.43E+00
792.0	-69.0	0.0	.11E+00
792.0	-138.0	0.0	.19E-01
1200.0	213.4	0.0	.16E-02
1200.0	106.7	0.0	.50E-01
1200.0	0.0	0.0	.28E+00
1200.0	-106.7	0.0	.18E+00
1200.0	-213.4	0.0	.20E-01
1600.0	224.2	0.0	.13E-01
1600.0	112.1	0.0	.43E-01
1600.0	0.0	0.0	.13E+00
1600.0	-112.1	0.0	.12E+00
1600.0	-224.2	0.0	.30E-01
87.0	0.0	17.8	.13E+01
87.0	0.0	39.4	.41E+00
187.0	0.0	17.8	.88E+00
187.0	0.0	39.4	.17E+00
366.0	0.0	17.8	.20E+00
366.0	0.0	39.4	.13E-01
792.0	0.0	30.5	.20E+00
792.0	0.0	50.8	.40E-01
1200.0	0.0	10.8	.89E-01
1200.0	0.0	30.5	.24E-01
1600.0	0.0	31.1	.15E-01

MAXIMUM VALUE

.32E+01

RUN NUMBER 48
 STABILITY G
 RELEASE HEIGHT (METERS) 22.60
 WIND DIRECTION 135

SAMPLE POSITION (METERS)			CONCENTRATION COEFFICIENT
X	Y	Z	
37.4	28.4	0.0	.12E+00
37.4	14.2	0.0	.37E+00
37.4	0.0	0.0	.40E+00
37.4	-14.2	0.0	.14E+00
37.4	-28.4	0.0	.13E-01
87.0	30.5	0.0	.96E-01
87.0	15.2	0.0	.64E+00
87.0	0.0	0.0	.69E+00
87.0	-15.2	0.0	.19E+00
87.0	-30.5	0.0	.22E-01
187.0	65.0	0.0	.16E-01
187.0	32.5	0.0	.21E+00
187.0	0.0	0.0	.82E+00
187.0	-32.5	0.0	.17E+00
187.0	-65.0	0.0	.15E-01
366.0	64.0	0.0	.41E-01
366.0	32.0	0.0	.25E+00
366.0	0.0	0.0	.30E+00
366.0	-32.0	0.0	.15E+00
366.0	-64.0	0.0	.67E-01
792.0	138.0	0.0	.15E-01
792.0	69.0	0.0	.18E-01
792.0	0.0	0.0	.47E+00
792.0	-69.0	0.0	.14E+00
792.0	-138.0	0.0	.22E-01
1200.0	213.4	0.0	.63E-02
1200.0	106.7	0.0	.47E-01
1200.0	0.0	0.0	.29E+00
1200.0	-106.7	0.0	.15E+00
1200.0	-213.4	0.0	.21E-01
1600.0	224.2	0.0	.18E-01
1600.0	112.1	0.0	.48E-01
1600.0	0.0	0.0	.79E-01
1600.0	-112.1	0.0	.70E-01
1600.0	-224.2	0.0	.18E-01
87.0	0.0	17.8	.15E+01
87.0	0.0	39.4	.50E+00
187.0	0.0	17.8	.11E+01
187.0	0.0	39.4	.27E+00
366.0	0.0	17.8	.26E+00
366.0	0.0	39.4	.50E-01
792.0	0.0	30.5	.25E+00
792.0	0.0	50.8	.55E-01
1200.0	0.0	10.8	.11E+00
1200.0	0.0	30.5	.44E-01
1600.0	0.0	31.1	.55E-01

MAXIMUM VALUE

.15E+01

RUN NUMBER 45
 STABILITY G
 RELEASE HEIGHT (METERS) 22.90
 WIND DIRECTION 135

SAMPLE POSITION (METERS)			CONCENTRATION COEFFICIENT
X	Y	Z	
37.4	28.4	0.0	.39E-01
37.4	14.2	0.0	.59E-01
37.4	0.0	0.0	.60E-01
37.4	-14.2	0.0	.27E-01
37.4	-28.4	0.0	.89E-02
87.0	30.5	0.0	.50E-01
87.0	15.2	0.0	.34E+00
87.0	0.0	0.0	.27E+00
87.0	-15.2	0.0	.39E-01
87.0	-30.5	0.0	.11E-01
187.0	65.0	0.0	.10E-01
187.0	32.5	0.0	.22E+00
187.0	0.0	0.0	.53E+00
187.0	-32.5	0.0	.46E-01
187.0	-65.0	0.0	.89E-02
366.0	64.0	0.0	.34E-01
366.0	32.0	0.0	.11E+00
366.0	0.0	0.0	.32E+00
366.0	-32.0	0.0	.67E-01
366.0	-64.0	0.0	.18E-01
792.0	138.0	0.0	.63E-02
792.0	69.0	0.0	.22E-01
792.0	0.0	0.0	.16E+00
792.0	-69.0	0.0	.67E-01
792.0	-138.0	0.0	.10E-01
1200.0	213.4	0.0	.17E-01
1200.0	106.7	0.0	.47E-01
1200.0	0.0	0.0	.28E+01
1200.0	-106.7	0.0	.72E+00
1200.0	-213.4	0.0	.10E-01
1600.0	224.2	0.0	.11E-01
1600.0	112.1	0.0	.72E+00
1600.0	0.0	0.0	.92E-01
1600.0	-112.1	0.0	.47E-01
1600.0	-224.2	0.0	.95E-02
87.0	0.0	17.8	.70E+00
87.0	0.0	39.4	.50E+00
187.0	0.0	17.8	.87E+00
187.0	0.0	39.4	.17E+00
366.0	0.0	17.8	.40E+00
366.0	0.0	39.4	.44E-01
792.0	0.0	30.5	.25E+00
792.0	0.0	50.8	.47E-01
1200.0	0.0	10.8	.23E+00
1200.0	0.0	30.5	.34E-01
1600.0	0.0	31.1	.50E-01

MAXIMUM VALUE

.28E+01

RUN NUMBER 56
 STABILITY G
 RELEASE HEIGHT (METERS) 0.00
 WIND DIRECTION 180

SAMPLE POSITION (METERS)			CONCENTRATION COEFFICIENT
X	Y	Z	
37.4	28.4	0.0	.85E-01
37.4	14.2	0.0	.21E+00
37.4	0.0	0.0	.14E+01
37.4	-14.2	0.0	.24E+01
37.4	-28.4	0.0	.81E+01
87.0	30.5	0.0	.47E+00
87.0	15.2	0.0	.11E+01
87.0	0.0	0.0	.17E+01
87.0	-15.2	0.0	.27E+01
87.0	-30.5	0.0	.21E+01
187.0	65.0	0.0	.56E-01
187.0	32.5	0.0	.42E+00
187.0	0.0	0.0	.95E+00
187.0	-32.5	0.0	.11E+01
187.0	-65.0	0.0	.22E+00
366.0	64.0	0.0	.11E+00
366.0	32.0	0.0	.21E+00
366.0	0.0	0.0	.34E+00
366.0	-32.0	0.0	.43E+00
366.0	-64.0	0.0	.63E+00
792.0	138.0	0.0	.33E-01
792.0	69.0	0.0	.58E-01
792.0	0.0	0.0	.10E+00
792.0	-69.0	0.0	.11E+00
792.0	-138.0	0.0	.26E+00
1200.0	213.4	0.0	.11E-01
1200.0	106.7	0.0	.67E-01
1200.0	0.0	0.0	.26E+00
1200.0	-106.7	0.0	.32E+00
1200.0	-213.4	0.0	.65E-01
1600.0	224.2	0.0	.29E-01
1600.0	112.1	0.0	.51E-01
1600.0	0.0	0.0	.21E+00
1600.0	-112.1	0.0	.19E+00
1600.0	-224.2	0.0	.53E-01
87.0	0.0	17.8	.80E+00
87.0	0.0	39.4	.26E+00
187.0	0.0	17.8	.55E+00
187.0	0.0	39.4	.26E-01
366.0	0.0	17.8	.13E+00
366.0	0.0	39.4	.21E-01
792.0	0.0	30.5	.13E+00
792.0	0.0	50.8	.36E-01
1200.0	0.0	10.8	.13E+00
1200.0	0.0	30.5	.13E-01
1600.0	0.0	31.1	.43E-01

MAXIMUM VALUE

.81E+01

RUN NUMBER 58
 STABILITY G
 RELEASE HEIGHT (METERS) 22.60
 WIND DIRECTION 180

SAMPLE POSITION (METERS)			CONCENTRATION COEFFICIENT
X	Y	Z	
37.4	28.4	0.0	.75E-01
37.4	14.2	0.0	.53E+00
37.4	0.0	0.0	.22E+01
37.4	-14.2	0.0	.16E+01
37.4	-28.4	0.0	.93E+00
87.0	30.5	0.0	.11E+01
87.0	15.2	0.0	.24E+01
87.0	0.0	0.0	.23E+01
87.0	-15.2	0.0	.11E+01
87.0	-30.5	0.0	.53E+00
187.0	65.0	0.0	.87E-01
187.0	32.5	0.0	.94E+00
187.0	0.0	0.0	.13E+01
187.0	-32.5	0.0	.61E+00
187.0	-65.0	0.0	.80E-01
366.0	64.0	0.0	.23E+00
366.0	32.0	0.0	.26E+00
366.0	0.0	0.0	.42E+00
366.0	-32.0	0.0	.30E+00
366.0	-64.0	0.0	.29E+00
792.0	138.0	0.0	.35E-01
792.0	69.0	0.0	.12E+00
792.0	0.0	0.0	.12E+00
792.0	-69.0	0.0	.11E+00
792.0	-138.0	0.0	.14E+00
1200.0	213.4	0.0	.17E-01
1200.0	106.7	0.0	.12E+00
1200.0	0.0	0.0	.32E+00
1200.0	-106.7	0.0	.17E+00
1200.0	-213.4	0.0	.37E-01
1600.0	224.2	0.0	.26E-01
1600.0	112.1	0.0	.93E-01
1600.0	0.0	0.0	.16E+00
1600.0	-112.1	0.0	.15E+00
1600.0	-224.2	0.0	.43E-01
87.0	0.0	17.8	.14E+01
87.0	0.0	39.4	.38E+00
187.0	0.0	17.8	.64E+00
187.0	0.0	39.4	.42E-01
366.0	0.0	17.8	.17E+00
366.0	0.0	39.4	.76E-01
792.0	0.0	30.5	.18E+00
792.0	0.0	50.8	.45E-01
1200.0	0.0	10.8	.18E+00
1200.0	0.0	30.5	.33E-01
1600.0	0.0	31.1	.70E-01

MAXIMUM VALUE

.24E+01

RUN NUMBER 55
 STABILITY G
 RELEASE HEIGHT (METERS) 29.00
 WIND DIRECTION 180

SAMPLE POSITION (METERS)			CONCENTRATION COEFFICIENT
X	Y	Z	
37.4	28.4	0.0	.12E-01
37.4	14.2	0.0	.10E+00
37.4	0.0	0.0	.42E+00
37.4	-14.2	0.0	.28E+00
37.4	-28.4	0.0	.11E+00
87.0	30.5	0.0	.24E+00
87.0	15.2	0.0	.95E+00
87.0	0.0	0.0	.60E+00
87.0	-15.2	0.0	.11E+00
87.0	-30.5	0.0	.55E-01
187.0	65.0	0.0	.32E-01
187.0	32.5	0.0	.71E+00
187.0	0.0	0.0	.10E+01
187.0	-32.5	0.0	.15E+00
187.0	-65.0	0.0	.16E-01
366.0	64.0	0.0	.13E+00
366.0	32.0	0.0	.19E+00
366.0	0.0	0.0	.41E+00
366.0	-32.0	0.0	.13E+00
366.0	-64.0	0.0	.72E-01
792.0	138.0	0.0	.13E-01
792.0	69.0	0.0	.63E-01
792.0	0.0	0.0	.59E+00
792.0	-69.0	0.0	.76E-01
792.0	-138.0	0.0	.80E-01
1200.0	213.4	0.0	.12E-01
1200.0	106.7	0.0	.95E-01
1200.0	0.0	0.0	.38E+00
1200.0	-106.7	0.0	.88E-01
1200.0	-213.4	0.0	.21E-01
1600.0	224.2	0.0	.22E-01
1600.0	112.1	0.0	.67E-01
1600.0	0.0	0.0	.94E-01
1600.0	-112.1	0.0	.70E-01
1600.0	-224.2	0.0	.15E-01
87.0	0.0	17.8	.51E+00
87.0	0.0	39.4	.51E+00
187.0	0.0	17.8	.71E+00
187.0	0.0	39.4	.39E-01
366.0	0.0	17.8	.25E+00
366.0	0.0	39.4	.43E-01
792.0	0.0	30.5	.20E+00
792.0	0.0	50.8	.31E-01
1200.0	0.0	10.8	.19E+00
1200.0	0.0	30.5	.24E-01
1600.0	0.0	31.1	.19E+00

MAXIMUM VALUE

.10E+01

RUN NUMBER 6G
 STABILITY G
 RELEASE HEIGHT (METERS) 0.00
 WIND DIRECTION 225

SAMPLE POSITION (METERS)			CONCENTRATION COEFFICIENT
X	Y	Z	
37.4	28.4	0.0	.11E+00
37.4	14.2	0.0	.23E+01
37.4	0.0	0.0	.49E+01
37.4	-14.2	0.0	.11E+02
37.4	-28.4	0.0	.15E+03
87.0	30.5	0.0	.20E+00
87.0	15.2	0.0	.18E+01
87.0	0.0	0.0	.32E+01
87.0	-15.2	0.0	.27E+01
87.0	-30.5	0.0	.17E+01
187.0	65.0	0.0	.12E-01
187.0	32.5	0.0	.28E+00
187.0	0.0	0.0	.13E+01
187.0	-32.5	0.0	.97E+00
187.0	-65.0	0.0	.17E+00
366.0	64.0	0.0	.41E-01
366.0	32.0	0.0	.15E+00
366.0	0.0	0.0	.41E+00
366.0	-32.0	0.0	.41E+00
366.0	-64.0	0.0	.49E+00
792.0	138.0	0.0	.11E-01
792.0	69.0	0.0	.26E-01
792.0	0.0	0.0	.14E+00
792.0	-69.0	0.0	.79E-01
792.0	-138.0	0.0	.16E-01
1200.0	213.4	0.0	.37E-02
1200.0	106.7	0.0	.46E+00
1200.0	0.0	0.0	.22E+00
1200.0	-106.7	0.0	.22E+00
1200.0	-213.4	0.0	.23E-01
1600.0	224.2	0.0	.90E-02
1600.0	112.1	0.0	.62E-01
1600.0	0.0	0.0	.15E+00
1600.0	-112.1	0.0	.15E+00
1600.0	-224.2	0.0	.12E-01
87.0	0.0	17.8	.13E+01
87.0	0.0	39.4	.15E+00
187.0	0.0	17.8	.66E+00
187.0	0.0	39.4	.48E-01
366.0	0.0	17.8	.15E+00
366.0	0.0	39.4	.33E-01
792.0	0.0	30.5	.14E+00
792.0	0.0	50.8	.24E-01
1200.0	0.0	10.8	.15E+00
1200.0	0.0	30.5	.31E-01
1600.0	0.0	31.1	.16E+00

MAXIMUM VALUE

.11E+02

RUN NUMBER 62
 STABILITY G
 RELEASE HEIGHT (METERS) 22.60
 WIND DIRECTION 225

SAMPLE POSITION (METERS)			CONCENTRATION COEFFICIENT
X	Y	Z	
37.4	28.4	0.0	.47E-01
37.4	14.2	0.0	.69E+00
37.4	0.0	0.0	.33E+00
37.4	-14.2	0.0	.70E-01
37.4	-28.4	0.0	.70E-02
87.0	30.5	0.0	.56E-01
87.0	15.2	0.0	.63E+00
87.0	0.0	0.0	.14E+01
87.0	-15.2	0.0	.65E+00
87.0	-30.5	0.0	.52E-01
187.0	65.0	0.0	.90E-02
187.0	32.5	0.0	.12E+00
187.0	0.0	0.0	.12E+01
187.0	-32.5	0.0	.35E+00
187.0	-65.0	0.0	.24E-01
366.0	64.0	0.0	.19E-01
366.0	32.0	0.0	.65E-01
366.0	0.0	0.0	.16E+00
366.0	-32.0	0.0	.18E+00
366.0	-64.0	0.0	.15E+00
792.0	138.0	0.0	.32E-02
792.0	69.0	0.0	.16E-01
792.0	0.0	0.0	.12E+00
792.0	-69.0	0.0	.29E-01
792.0	-138.0	0.0	.77E-02
1200.0	213.4	0.0	.45E-02
1200.0	106.7	0.0	.38E-01
1200.0	0.0	0.0	.31E+00
1200.0	-106.7	0.0	.10E+00
1200.0	-213.4	0.0	.19E-01
1600.0	224.2	0.0	.10E-01
1600.0	112.1	0.0	.68E-01
1600.0	0.0	0.0	.93E-01
1600.0	-112.1	0.0	.33E-01
1600.0	-224.2	0.0	.96E-02
87.0	0.0	17.8	.19E+01
87.0	0.0	39.4	.64E+00
187.0	0.0	17.8	.13E+01
187.0	0.0	39.4	.15E+00
366.0	0.0	17.8	.25E+00
366.0	0.0	39.4	.48E-01
792.0	0.0	30.5	.23E+00
792.0	0.0	50.8	.44E-01
1200.0	0.0	10.8	.23E+00
1200.0	0.0	30.5	.54E-01
1600.0	0.0	31.1	.20E+00

MAXIMUM VALUE

.19E+01

RUN NUMBER 65
 STABILITY G
 RELEASE HEIGHT (METERS) 29.00
 WIND DIRECTION 225

SAMPLE POSITION (METERS)			CONCENTRATION COEFFICIENT
X	Y	Z	
37.4	28.4	0.0	.58E-02
37.4	14.2	0.0	.83E-02
37.4	0.0	0.0	.77E-02
37.4	-14.2	0.0	.64E-02
37.4	-28.4	0.0	.32E-02
87.0	30.5	0.0	.64E-02
87.0	15.2	0.0	.45E-01
87.0	0.0	0.0	.14E+00
87.0	-15.2	0.0	.60E-01
87.0	-30.5	0.0	.12E-01
187.0	65.0	0.0	.58E-02
187.0	32.5	0.0	.28E-01
187.0	0.0	0.0	.64E+00
187.0	-32.5	0.0	.96E-01
187.0	-65.0	0.0	.70E-02
366.0	64.0	0.0	.58E-02
366.0	32.0	0.0	.35E-01
366.0	0.0	0.0	.35E+00
366.0	-32.0	0.0	.12E+00
366.0	-64.0	0.0	.28E-01
792.0	138.0	0.0	.32E-02
792.0	69.0	0.0	.12E-01
792.0	0.0	0.0	.48E+00
792.0	-69.0	0.0	.56E-01
792.0	-138.0	0.0	.83E-02
1200.0	213.4	0.0	.26E-02
1200.0	106.7	0.0	.28E-01
1200.0	0.0	0.0	.20E+00
1200.0	-106.7	0.0	.72E-01
1200.0	-213.4	0.0	.70E-02
1600.0	224.2	0.0	.32E-02
1600.0	112.1	0.0	.54E-01
1600.0	0.0	0.0	.67E-01
1600.0	-112.1	0.0	.24E-01
1600.0	-224.2	0.0	.38E-02
87.0	0.0	17.8	.35E+00
87.0	0.0	39.4	.11E+01
187.0	0.0	17.8	.13E+01
187.0	0.0	39.4	.21E+00
366.0	0.0	17.8	.41E+00
366.0	0.0	39.4	.28E+00
792.0	0.0	30.5	.31E+00
792.0	0.0	50.8	.60E-01
1200.0	0.0	10.8	.19E+00
1200.0	0.0	30.5	.19E-01
1600.0	0.0	31.1	.23E+00

MAXIMUM VALUE

.13E+01

RUN NUMBER 76
 STABILITY G
 RELEASE HEIGHT (METERS) 0.00
 WIND DIRECTION 270

SAMPLE POSITION (METERS)			CONCENTRATION COEFFICIENT
X	Y	Z	
37.4	28.4	0.0	.42E+00
37.4	14.2	0.0	.10E+01
37.4	0.0	0.0	.33E+01
37.4	-14.2	0.0	.64E+01
37.4	-28.4	0.0	.26E+02
87.0	30.5	0.0	.48E+00
87.0	15.2	0.0	.39E+00
87.0	0.0	0.0	.10E+01
87.0	-15.2	0.0	.12E+01
87.0	-30.5	0.0	.16E+01
187.0	65.0	0.0	.37E-01
187.0	32.5	0.0	.17E+00
187.0	0.0	0.0	.47E+00
187.0	-32.5	0.0	.68E+00
187.0	-65.0	0.0	.10E+01
366.0	64.0	0.0	.43E-01
366.0	32.0	0.0	.26E+00
366.0	0.0	0.0	.33E+00
366.0	-32.0	0.0	.48E+00
366.0	-64.0	0.0	.42E+00
792.0	138.0	0.0	.27E-01
792.0	69.0	0.0	.14E-01
792.0	0.0	0.0	.16E+00
792.0	-69.0	0.0	.15E+00
792.0	-138.0	0.0	.68E-01
1200.0	213.4	0.0	.11E-01
1200.0	106.7	0.0	.38E-01
1200.0	0.0	0.0	.11E+00
1200.0	-106.7	0.0	.35E+00
1200.0	-213.4	0.0	.56E-01
1600.0	224.2	0.0	.22E-01
1600.0	112.1	0.0	.20E-01
1600.0	0.0	0.0	.42E+00
1600.0	-112.1	0.0	.40E+00
1600.0	-224.2	0.0	.93E-01
87.0	0.0	17.8	.31E+00
87.0	0.0	39.4	.49E-01
187.0	0.0	17.8	.29E+00
187.0	0.0	39.4	.41E-01
366.0	0.0	17.8	.85E-01
366.0	0.0	39.4	.39E-01
792.0	0.0	30.5	.11E+00
792.0	0.0	57.8	.54E-01
1200.0	0.0	10.8	.12E+00
1200.0	0.0	30.5	.16E-01
1600.0	0.0	31.1	.13E+00

MAXIMUM VALUE

.26E+02

RUN NUMBER 78
 STABILITY G
 RELEASE HEIGHT (METERS) 22.60
 WIND DIRECTION 270

SAMPLE POSITION (METERS)			CONCENTRATION COEFFICIENT
X	Y	Z	
37.4	28.4	0.0	.74E+00
37.4	14.2	0.0	.26E+01
37.4	0.0	0.0	.38E+01
37.4	-14.2	0.0	.28E+01
37.4	-28.4	0.0	.63E+00
87.0	30.5	0.0	.26E+00
87.0	15.2	0.0	.12E+01
87.0	0.0	0.0	.45E+01
87.0	-15.2	0.0	.43E+01
87.0	-30.5	0.0	.26E+01
187.0	65.0	0.0	.40E-01
187.0	32.5	0.0	.50E+00
187.0	0.0	0.0	.13E+01
187.0	-32.5	0.0	.11E+01
187.0	-65.0	0.0	.32E+00
366.0	64.0	0.0	.79E-01
366.0	32.0	0.0	.17E+00
366.0	0.0	0.0	.36E+00
366.0	-32.0	0.0	.37E+00
366.0	-64.0	0.0	.25E+00
792.0	138.0	0.0	.15E-01
792.0	69.0	0.0	.29E-01
792.0	0.0	0.0	.29E+00
792.0	-69.0	0.0	.16E+00
792.0	-138.0	0.0	.29E-01
1200.0	213.4	0.0	.90E-02
1200.0	106.7	0.0	.61E-01
1200.0	0.0	0.0	.20E+00
1200.0	-106.7	0.0	.27E+00
1200.0	-213.4	0.0	.29E-01
1600.0	224.2	0.0	.17E-01
1600.0	112.1	0.0	.49E-01
1600.0	0.0	0.0	.19E+00
1600.0	-112.1	0.0	.15E+00
1600.0	-224.2	0.0	.38E-01
87.0	0.0	17.8	.10E+01
87.0	0.0	39.4	.64E+00
187.0	0.0	17.8	.70E+00
187.0	0.0	39.4	.52E-01
366.0	0.0	17.8	.14E+00
366.0	0.0	39.4	.42E-01
792.0	0.0	30.5	.15E+00
792.0	0.0	50.8	.42E-01
1200.0	0.0	10.8	.17E+00
1200.0	0.0	30.5	.26E-01
1600.0	0.0	31.1	.17E+00

MAXIMUM VALUE

.45E+01

RUN NUMBER 7S
 STABILITY G
 RELEASE HEIGHT (METERS) 29.30
 WIND DIRECTION 270

SAMPLE POSITION (METERS)			CONCENTRATION COEFFICIENT
X	Y	Z	
37.4	28.4	0.0	.49E-01
37.4	14.2	0.0	.15E+00
37.4	0.0	0.0	.21E+00
37.4	-14.2	0.0	.18E+00
37.4	-28.4	0.0	.60E-01
87.0	30.5	0.0	.53E-01
87.0	15.2	0.0	.22E+00
87.0	0.0	0.0	.11E+01
87.0	-15.2	0.0	.28E+00
87.0	-30.5	0.0	.64E+00
187.0	65.0	0.0	.22E-01
187.0	32.5	0.0	.13E+00
187.0	0.0	0.0	.15E+01
187.0	-32.5	0.0	.15E+01
187.0	-65.0	0.0	.13E+00
366.0	64.0	0.0	.40E-01
366.0	32.0	0.0	.86E-01
366.0	0.0	0.0	.33E+00
366.0	-32.0	0.0	.43E+00
366.0	-64.0	0.0	.53E+00
792.0	138.0	0.0	.20E-01
792.0	69.0	0.0	.33E-01
792.0	0.0	0.0	.71E-01
792.0	-69.0	0.0	.29E+00
792.0	-138.0	0.0	.63E-01
1200.0	213.4	0.0	.26E-01
1200.0	106.7	0.0	.31E-01
1200.0	0.0	0.0	.22E+00
1200.0	-106.7	0.0	.22E+00
1200.0	-213.4	0.0	.18E+00
1600.0	224.2	0.0	.18E-01
1600.0	112.1	0.0	.38E-01
1600.0	0.0	0.0	.54E-01
1600.0	-112.1	0.0	.45E-01
1600.0	-224.2	0.0	.10E-01
87.0	0.0	17.8	.21E+01
87.0	0.0	39.4	.16E+01
187.0	0.0	17.8	.79E+00
187.0	0.0	39.4	.46E-01
366.0	0.0	17.8	.16E+00
366.0	0.0	39.4	.45E-01
792.0	0.0	30.5	.16E+00
792.0	0.0	50.8	.45E-01
1200.0	0.0	10.8	.19E+00
1200.0	0.0	30.5	.22E-01
1600.0	0.0	31.1	.17E+00

MAXIMUM VALUE

.21E+01

RUN NUMBER 86
 STABILITY G
 RELEASE HEIGHT (METERS) 0.00
 WIND DIRECTION 315

SAMPLE POSITION (METERS)			CONCENTRATION COEFFICIENT
X	Y	Z	
37.4	28.4	0.0	.17E+00
37.4	14.2	0.0	.33E+00
37.4	0.0	0.0	.14E+01
37.4	-14.2	0.0	.35E+01
37.4	-28.4	0.0	.32E+01
87.0	30.5	0.0	.11E+00
87.0	15.2	0.0	.34E+00
87.0	0.0	0.0	.90E+00
87.0	-15.2	0.0	.12E+01
87.0	-30.5	0.0	.14E+01
187.0	65.0	0.0	.19E-01
187.0	32.5	0.0	.18E+00
187.0	0.0	0.0	.47E+00
187.0	-32.5	0.0	.78E+00
187.0	-65.0	0.0	.27E+00
366.0	64.0	0.0	.43E-01
366.0	32.0	0.0	.72E-01
366.0	0.0	0.0	.20E+00
366.0	-32.0	0.0	.23E+00
366.0	-64.0	0.0	.40E+00
792.0	138.0	0.0	.32E-02
792.0	69.0	0.0	.26E-01
792.0	0.0	0.0	.16E+00
792.0	-69.0	0.0	.27E-01
792.0	-138.0	0.0	.63E-02
1200.0	213.4	0.0	.37E-02
1200.0	106.7	0.0	.37E-01
1200.0	0.0	0.0	.17E+00
1200.0	-106.7	0.0	.25E+00
1200.0	-213.4	0.0	.25E+00
1600.0	224.2	0.0	.17E-01
1600.0	112.1	0.0	.22E-01
1600.0	0.0	0.0	.75E-01
1600.0	-112.1	0.0	.49E-01
1600.0	-224.2	0.0	.46E-01
87.0	0.0	17.8	.63E-01
87.0	0.0	39.4	.49E-01
187.0	0.0	17.8	.33E+00
187.0	0.0	39.4	.30E+00
366.0	0.0	17.8	.21E+00
366.0	0.0	39.4	.10E+00
792.0	0.0	30.5	.17E+00
792.0	0.0	50.8	.23E-01
1200.0	0.0	10.8	.98E-01
1200.0	0.0	30.5	.41E-01
1600.0	0.0	31.1	.84E-01

MAXIMUM VALUE

.35E+01

RUN NUMBER 88
 STABILITY G
 RELEASE HEIGHT (METERS) 22.60
 WIND DIRECTION 315

SAMPLE POSITION (METERS)			CONCENTRATION COEFFICIENT
X	Y	Z	
37.4	28.4	0.0	.38E-01
37.4	14.2	0.0	.19E+00
37.4	0.0	0.0	.47E+00
37.4	-14.2	0.0	.21E+00
37.4	-28.4	0.0	.29E-01
87.0	30.5	0.0	.44E-01
87.0	15.2	0.0	.36E+00
87.0	0.0	0.0	.55E+00
87.0	-15.2	0.0	.48E+00
87.0	-30.5	0.0	.14E+00
187.0	65.0	0.0	.83E-02
187.0	32.5	0.0	.16E+00
187.0	0.0	0.0	.52E+00
187.0	-32.5	0.0	.21E+00
187.0	-65.0	0.0	.11E-01
366.0	64.0	0.0	.33E-01
366.0	32.0	0.0	.68E-01
366.0	0.0	0.0	.21E+00
366.0	-32.0	0.0	.12E+00
366.0	-64.0	0.0	.80E-01
792.0	138.0	0.0	.26E-02
792.0	69.0	0.0	.28E-01
792.0	0.0	0.0	.25E+00
792.0	-69.0	0.0	.35E-01
792.0	-138.0	0.0	.90E-02
1200.0	213.4	0.0	.58E-02
1200.0	106.7	0.0	.52E-01
1200.0	0.0	0.0	.18E+00
1200.0	-106.7	0.0	.90E-01
1200.0	-213.4	0.0	.10E+00
1600.0	224.2	0.0	.58E-02
1600.0	112.1	0.0	.47E-01
1600.0	0.0	0.0	.16E+00
1600.0	-112.1	0.0	.73E-01
1600.0	-224.2	0.0	.42E-01
87.0	0.0	17.8	.26E-01
87.0	0.0	39.4	.38E+00
187.0	0.0	17.8	.56E+00
187.0	0.0	39.4	.50E+00
366.0	0.0	17.8	.19E+00
366.0	0.0	39.4	.16E+00
792.0	0.0	30.5	.30E+00
792.0	0.0	50.8	.47E-01
1200.0	0.0	10.8	.15E+00
1200.0	0.0	30.5	.52E-01
1600.0	0.0	31.1	.12E+00

MAXIMUM VALUE

.56E+00

RUN NUMBER 85
 STABILITY G
 RELEASE HEIGHT (METERS) 29.00
 WIND DIRECTION 315

SAMPLE POSITION (METERS)			CONCENTRATION COEFFICIENT
X	Y	Z	
37.4	28.4	0.0	.29E-01
37.4	14.2	0.0	.11E+00
37.4	0.0	0.0	.32E+00
37.4	-14.2	0.0	.17E+00
37.4	-28.4	0.0	.20E-01
87.0	30.5	0.0	.48E-01
87.0	15.2	0.0	.26E+00
87.0	0.0	0.0	.53E+00
87.0	-15.2	0.0	.49E+00
87.0	-30.5	0.0	.10E+00
187.0	65.0	0.0	.83E-02
187.0	32.5	0.0	.12E+00
187.0	0.0	0.0	.53E+00
187.0	-32.5	0.0	.24E+00
187.0	-65.0	0.0	.13E-01
366.0	64.0	0.0	.14E-01
366.0	32.0	0.0	.14E+00
366.0	0.0	0.0	.41E+00
366.0	-32.0	0.0	.17E+00
366.0	-64.0	0.0	.80E-01
792.0	138.0	0.0	.70E-02
792.0	69.0	0.0	.27E-01
792.0	0.0	0.0	.35E-01
792.0	-69.0	0.0	.99E-01
792.0	-138.0	0.0	.70E-02
1200.0	213.4	0.0	.96E-02
1200.0	106.7	0.0	.24E-01
1200.0	0.0	0.0	.43E-01
1200.0	-106.7	0.0	.93E-01
1200.0	-213.4	0.0	.90E-02
1600.0	224.2	0.0	.64E-02
1600.0	112.1	0.0	.28E-01
1600.0	0.0	0.0	.58E-01
1600.0	-112.1	0.0	.39E-01
1600.0	-224.2	0.0	.58E-02
87.0	0.0	17.8	.21E+00
87.0	0.0	39.4	.26E+00
187.0	0.0	17.8	.60E+00
187.0	0.0	39.4	.25E+00
366.0	0.0	17.8	.15E+00
366.0	0.0	39.4	.56E-01
792.0	0.0	30.5	.14E+00
792.0	0.0	50.8	.44E-01
1200.0	0.0	10.8	.14E+00
1200.0	0.0	30.5	.24E-01
1600.0	0.0	31.1	.11E+00

MAXIMUM VALUE

.60E+00

RUN NUMBER 96
 STABILITY G
 RELEASE HEIGHT (METERS) 0.00
 WIND DIRECTION 0

SAMPLE POSITION (METERS)			CONCENTRATION COEFFICIENT
X	Y	Z	
37.4	28.4	0.0	0.
37.4	14.2	0.0	.53E-02
37.4	0.0	0.0	.32E+00
37.4	-14.2	0.0	.56E-01
37.4	-28.4	0.0	.42E-02
87.0	30.5	0.0	.21E-02
87.0	15.2	0.0	.55E-01
87.0	0.0	0.0	.11E+00
87.0	-15.2	0.0	.46E+00
87.0	-30.5	0.0	.78E-01
187.0	65.0	0.0	.32E-02
187.0	32.5	0.0	.90E-02
187.0	0.0	0.0	.27E+00
187.0	-32.5	0.0	.16E+00
187.0	-65.0	0.0	.58E-02
366.0	64.0	0.0	.32E-02
366.0	32.0	0.0	.20E-01
366.0	0.0	0.0	.26E+00
366.0	-32.0	0.0	.26E+00
366.0	-64.0	0.0	.48E-01
792.0	138.0	0.0	.48E-02
792.0	69.0	0.0	.48E-02
792.0	0.0	0.0	.16E+00
792.0	-69.0	0.0	.21E-02
792.0	-138.0	0.0	.12E-01
1200.0	213.4	0.0	.16E-02
1200.0	106.7	0.0	.14E-01
1200.0	0.0	0.0	.16E+00
1200.0	-106.7	0.0	.91E-01
1200.0	-213.4	0.0	.11E-01
1600.0	224.2	0.0	.16E-02
1600.0	112.1	0.0	.12E-01
1600.0	0.0	0.0	.81E-01
1600.0	-112.1	0.0	.70E-01
1600.0	-224.2	0.0	.16E-02
87.0	0.0	17.8	.62E+00
87.0	0.0	39.4	.42E+00
187.0	0.0	17.8	.47E+00
187.0	0.0	39.4	.38E+00
366.0	0.0	17.8	.25E+00
366.0	0.0	39.4	.53E-01
792.0	0.0	30.5	.15E+00
792.0	0.0	50.8	.46E-01
1200.0	0.0	10.8	.13E+00
1200.0	0.0	30.5	.32E-01
1600.0	0.0	31.1	.11E+00

MAXIMUM VALUE

.62E+00

RUN NUMBER 90
 STABILITY G
 RELEASE HEIGHT (METERS) 22.60
 WIND DIRECTION 0

SAMPLE POSITION (METERS)			CONCENTRATION COEFFICIENT
X	Y	Z	
37.4	29.4	0.0	.45E-02
37.4	14.2	0.0	.58E-02
37.4	0.0	0.0	.64E-02
37.4	-14.2	0.0	.58E-02
37.4	-28.4	0.0	.51E-02
87.0	30.5	0.0	.51E-02
87.0	15.2	0.0	.64E-02
87.0	0.0	0.0	.11E-01
87.0	-15.2	0.0	.13E-01
87.0	-30.5	0.0	.45E-02
187.0	65.0	0.0	.38E-02
187.0	32.5	0.0	.38E-02
187.0	0.0	0.0	.53E-01
187.0	-32.5	0.0	.13E-01
187.0	-65.0	0.0	.38E-02
366.0	64.0	0.0	.38E-02
366.0	32.0	0.0	.14E-01
366.0	0.0	0.0	.74E-01
366.0	-32.0	0.0	.56E-01
366.0	-64.0	0.0	.83E-02
792.0	138.0	0.0	.51E-02
792.0	69.0	0.0	.83E-02
792.0	0.0	0.0	.12E+00
792.0	-69.0	0.0	.19E-01
792.0	-138.0	0.0	.58E-02
1200.0	213.4	0.0	.64E-03
1200.0	106.7	0.0	.12E-01
1200.0	0.0	0.0	.12E+00
1200.0	-106.7	0.0	.37E-01
1200.0	-213.4	0.0	.58E-02
1600.0	224.2	0.0	.38E-02
1600.0	112.1	0.0	.13E-01
1600.0	0.0	0.0	.48E-01
1600.0	-112.1	0.0	.40E-01
1600.0	-224.2	0.0	.19E-02
87.0	0.0	17.8	.21E+00
87.0	0.0	39.4	.64E+00
187.0	0.0	17.8	.28E+00
187.0	0.0	39.4	.59E+00
366.0	0.0	17.8	.23E+00
366.0	0.0	39.4	.49E-01
792.0	0.0	30.5	.19E+00
792.0	0.0	50.8	.61E-01
1200.0	0.0	10.8	.16E+00
1200.0	0.0	30.5	.40E-01
1600.0	0.0	31.1	.12E+00

MAXIMUM VALUE

.64E+00

RUN NUMBER 9S
 STABILITY G
 RELEASE HEIGHT (METERS) 29.00
 WIND DIRECTION 3

SAMPLE POSITION (METERS)			CONCENTRATION COEFFICIENT
X	Y	Z	
37.4	28.4	0.0	.38E-02
37.4	14.2	0.0	.32E-02
37.4	0.0	0.0	.32E-02
37.4	-14.2	0.0	.32E-02
37.4	-28.4	0.0	.32E-02
87.0	30.5	0.0	.32E-02
87.0	15.2	0.0	.32E-02
87.0	0.0	0.0	.32E-02
87.0	-15.2	0.0	.38E-02
87.0	-30.5	0.0	.32E-02
187.0	65.0	0.0	.32E-02
187.0	32.5	0.0	.32E-02
187.0	0.0	0.0	.18E-01
187.0	-32.5	0.0	.83E-02
187.0	-65.0	0.0	.32E-02
366.0	64.0	0.0	.32E-02
366.0	32.0	0.0	.83E-02
366.0	0.0	0.0	.27E-01
366.0	-32.0	0.0	.36E-01
366.0	-64.0	0.0	.58E-02
792.0	138.0	0.0	.32E-02
792.0	69.0	0.0	.38E-02
792.0	0.0	0.0	.79E-01
792.0	-69.0	0.0	.29E-01
792.0	-138.0	0.0	.32E-02
1200.0	213.4	0.0	.32E-02
1200.0	106.7	0.0	.64E-02
1200.0	0.0	0.0	.86E-01
1200.0	-106.7	0.0	.29E-01
1200.0	-213.4	0.0	.18E-01
1600.0	224.2	0.0	.18E-01
1600.0	112.1	0.0	.17E-01
1600.0	0.0	0.0	.19E+00
1600.0	-112.1	0.0	.18E+00
1600.0	-224.2	0.0	.32E-02
87.0	0.0	17.8	.11E+00
87.0	0.0	39.4	.96E+00
187.0	0.0	17.8	.18E+00
187.0	0.0	39.4	.76E+00
366.0	0.0	17.8	.19E+00
366.0	0.0	39.4	.12E+00
792.0	0.0	30.5	.22E+00
792.0	0.0	59.8	.81E-01
1200.0	0.0	10.8	.17E+00
1200.0	0.0	30.5	.35E-01
1600.0	0.0	31.1	.12E+00

MAXIMUM VALUE

.96E+00