

C851

47

v. 3

SL

ISSN 0737-5352
CIRA
Paper No.

3

Satellite Data Support to the Pre-Storm Operations Center

May-June 1985

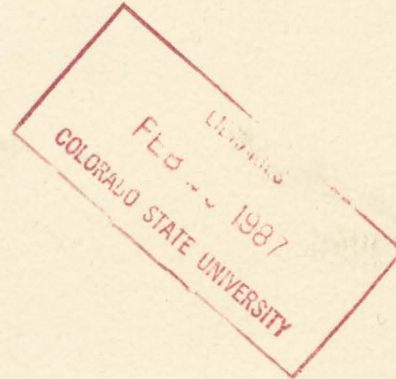

Cooperative Institute for Research in the Atmosphere

Colorado State University
Foothills Campus
Fort Collins, Colorado 80523

Colorado State University / National Oceanic and Atmospheric Administration

This Report was supported under NOAA Grants

#NA84AA-D-00017 - Mesoscale Analysis and Forecast Product Development
for Severe Storm Nowcasting

and

#NA84AA-H-00020 - Research and Development Activities in Support of the
NOAA Operational VAS Assessment (NOVA) Program

Co-Principal Investigators

Thomas H. Vonder Haar
James F.W. Purdom

CIRA Paper No. 3

**Satellite Data Support
to the
Pre-Storm Operations Center
May - June 1985**

**J.F.W. Purdom
R.N. Green
J.F. Weaver
R.M. Zehr
D.A. Lubich**

**Colorado State University
Fort Collins, Colorado 80523
September 1985**



U18400 9371783

QC
851
.C47
no. 3
ATSL

Table of Contents

List of Tables	ii
List of Figures	iii
Abstract	1
1. Introduction	2
2. Personal Computer Workstation for Satellite Data - Input to the PRE-STORM Operations Center, R.N. Green	8
3. Display and Analysis of Image Products on the IBM-PC Workstation, J.F.W. Purdom	24
4. Display and Analysis of VAS Retrievals on the IBM-PC Workstation, R.M. Zehr	34
5. Real-Time Support to PRE-STORM: 26 April - 27 June 1985, J.F. Weaver	51
6. Satellite Data and Products Archived at CIRA - Emphasis on IBM-PC Products, D. Lubich	58
7. Conclusion & Recommendations	69
8. Areas of Future Research	72
9. Acknowledgements	74
10. References	75

List of Tables

Table 1.	VAS Instrument Characteristics	3
Table 2.	GOES Schedule with VAS	5
Table 3.	1985 GOES-6 RISOP Schedule	6
Table 4.	PRE-STORM Temperature Ranges versus IBM PC Colors	30
Table 5.	Parameters Derived from Each VAS Retrieval	36-37
Table 6a.	PRE-STORM Data Archive May 1985	59
Table 6b.	PRE-STORM Data Archive June 1985	60
Table 7.	RISOP Start Times -- 1985, PRE-STORM Season	61
Table 8a.	PRE-STORM IBM-PC Data Archival -- May 1985 (0000Z - 0730Z)	62
Table 8b.	PRE-STORM IBM-PC Data Archival -- May 1985 (0800Z - 1530Z)	63
Table 8c.	PRE-STORM IBM-PC Data Archival -- May 1985 (1600Z - 2330Z)	64
Table 9a.	PRE-STORM IBM-PC Data Archival -- June 1985 (0000Z - 0730Z)	65
Table 9b.	PRE-STORM IBM-PC Data Archival -- June 1985 (0800Z - 1530Z)	66
Table 9c.	PRE-STORM IBM-PC Data Archival -- June 1985 (1600Z - 2330Z)	67
Table 10.	VAS Retrieval Data Archived at University of Wisconsin -- 1985, PRE-STORM Season	68

List of Figures

1. System configuration schematic diagram of the CIRA/RAMM Branch PC workstation used in the PRE-STORM Operations Center.	9
2. Menu structure for the PRE-STORM workstation software.	12
3.1. Satellite data workstation.	13
3.2. PRE-STORM satellite operations menu.	14
3.3. Display control instructions.	14
3.4. Image analysis (low res mode) menu.	16
3.5. IR image selection	16
3.6. Cursor/Image Operations Menu	17
3.7. Histogram menu.	18
3.8. Cursor operations to dump image.	18
3.9. VAS retrieval analysis menu.	19
3.10. List of areas for graphics initialization.	19
3.11. Menu for manually acquired retrieval files.	20
3.12. Product transfer menu.	22
3.13. Menu for manually acquired products.	23
4. Areas covered by PRE-STORM sectors. North (N), Central (C), and Southern (S). The Northern and Southern boundaries of the S sector are dashed. The N sector is offset from C and S in an East-West direction.	25
5. Half-tone VIS image from 10 June 1985 at 2000 GMT.	26
6a. 6.7 μm water vapor imagery from 10 June 1985 at 2300 GMT.	28
6b. 6.7 μm water vapor imagery from 10 June 1985 at 1700 GMT.	28
7. Infrared image from 10 June 1985 at 2300 GMT.	29
8. Infrared image from 11 June 1985 at 0300 GMT. Rectangular region indicates interactively chosen area for statistical analysis (see text).	32
9. Histogram of brightness counts in rectangular area shown in Figure 8.	32

10.	Growth rates for selected isotherms (area of that temperature and colder) for the June 10-11 mesoscale convective system.	33
11.	Listing of data available from an individual retrieval file transmitted from ASPP, University of Wisconsin to IBM-PC workstation.	35
12.	Example of 500 mb geopotential heights plotted from VAS retrievals in PRE-STORM area for 6 May 1985 at 1418 GMT.	38
13.	IBM-PC workstation objective analysis of VAS 500 mb geopotential heights for 6 May 1985 at 1418 GMT.	38
14.	IBM-PC workstation sounding analysis output showing derived parameters from a VAS retrieval.	39
15a.	Example of a "positive area" analysis from PRE-STORM. $B(\text{Jkg}^{-1})$ for 6 May 1985 at 2318 GMT.	41
15b.	IR satellite image from IBM-PC workstation for 7 May 1985 at 0500 GMT.	41
16.	Diagram illustrative bulk thermodynamic parameters computed from VAS retrievals on a skew-T, log-P thermodynamic chart. <ol style="list-style-type: none"> 1. "positive area", B, available buoyant chart. 2. "negative area", N, between LCL and LFC. 3. "negative area", N, between the surface and the LCL. 4. "heating area", H, heat energy needed to reach convective temperature, T_c. 5. "positive area", B_{CCL}, assuming convective temperature is reached. 	42
17a.	B_{CCL} , positive area assuming convective temperature, and analysis of convective temperature for 6 May 1985 at 1718 GMT (the shaded region is where $B_{\text{CCL}} \geq 800 \text{ Jkg}^{-1}$ and $T_c \leq 33^\circ$).	44
17b.	B, "positive area" for 6 May 1985 at 1718 GMT.	45
17c.	B, "positive area" for 6 May 1985 at 2018 GMT.	45
17d.	Radar summary chart, for 7 May 1985 at 0235 GMT.	46
17e.	IR satellite image from IBM-PC for 7 May 1985 at 0300 GMT.	46
18a.	Analysis of lowest kilometer dew point ($^\circ\text{C}$) from the VAS retrievals for 20 June 1985 at 1718 GMT.	48

18b.	Analysis of surface dew point, ($^{\circ}\text{C}$, plotted values are $^{\circ}\text{K}$) for June 1985 at 1718 GMT.	48
18c.	Stephenville, TX, (SEP), radiosonde observation for 20 June 1985 at 1200 GMT.	49
19.	Hours that the NESDIS, PC workstation was manned (work hours) during PRE-STORM. Time shown is Central Standard Time (CST), and reads from the origin upward.	52
20.	PRE-STORM flight missions. Times (CST) shown are those during which aircraft were actually in the air. Also indicated are the locations of the flights, and an abbreviated mission description.	54

Abstract

The activities of CIRA are described with regard to satellite support of the field phase of the Oklahoma-Kansas PRE-STORM experiment, and to the ongoing research projects which make use of PRE-STORM data sets. Routine GOES imagery and VAS products were displayed on a personal computer (PC) workstation located in the PRE-STORM operations support facility. Half-hourly visible and infrared imagery, two-hourly water vapor imagery, and a number of derived VAS sounding products were available in real-time. The impact of the PC workstation on PRE-STORM operations is discussed. The image display and analysis products, and VAS data products for use on the PC workstation are described in detail. Finally, PC data archival procedures and preliminary plans for future research are presented.



CIRA PRE-STORM Satellite Workstation

1. INTRODUCTION

The PRE-STORM program is a three to five year effort designed to improve our physical understanding of mesoscale convective systems (MCS's). A long range goal of that effort is an improved capability to forecast the development and evolution of MCS's along with the various types of weather occurring with them. An initial phase of the PRE-STORM program took place during the summer of 1985 with the Oklahoma-Kansas PRE-STORM program. That program had two major goals:

- 1) Investigate the development, evolution and structure of MCS's using a sophisticated array of surface mesonet sensors, aircraft, conventional and Doppler radar, surface based profilers and polar and geostationary satellite data; and
- 2) Evaluate new sensing systems to develop observational strategies that would help in the design of follow-on experiments.

The enclosed NOAA flyer gives a brief description of the Oklahoma-Kansas PRE-STORM program.

Both polar orbiting and geostationary satellite data were (are) being used to support the Oklahoma/Kansas PRE-STORM program. While the polar orbiting data* are only available in a retrospective mode, one GOES-VAS satellite was in operation and provided timely data during the PRE-STORM field program. That geostationary satellite, located over the central United States, was operated in one of three modes: 1) a normal visible and infrared imaging mode; 2) a multi-spectral imaging (MSI) mode which includes visible and infrared imagery as well as other channel imagery; or 3) a dwell sounding mode in which multi-channel VAS

*These lower polar orbiting passes provide only periodic but higher resolution (≈ 1 km) multispectral imagery than GOES over the Kansas/Oklahoma region. They also provide sounding information, in the presence of clouds, from a passive microwave instrument.

data are taken and from which soundings are derived. Channel characteristics are shown in Table 1. It is only possible to operate in one of the three modes at any given time. Dwell soundings were processed in real time by the Advanced Satellite Products Project (ASPP) of NESDIS at the University of Wisconsin. At the ASPP, VAS related products in support of the Oklahoma/Kansas PRE-STORM experiment were generated for transmission to the operations center.

Table 1. VAS Instrument Characteristics

Spectral Channel	Central Wavelength ($\mu\text{m} = 10^{-6}\text{m}$)	Absorbing Constituent	Weighting Function		
			Peak Level (mb)	Representative Thickness (mb)	Surface or Cloud Emission Effect
1	14.7	CO ₂	40	150-10	usually none
2	14.5	CO ₂	70	200-30	nothing below 500 mb
3	14.2	CO ₂	300	500-10	nothing below 800 mb
4	14.0	CO ₂	450	800-300	weak
5	13.3	CO ₂	950	SFC-500	moderate
6	4.5	CO ₂	850	SFC-500	moderate
7	12.7	H ₂ O	surface	SFC-700	strong
8	11.2	window	surface	---	strong
9	7.2	H ₂ O	600	800-400	weak at sfc
10	6.7	H ₂ O	450	700-250	nothing at sfc
11	4.4	CO ₂	500	800-100	weak
12	3.9	window	surface	---	strong

The normal GOES operational schedule called for half-hourly imagery over the USA with VAS data interspersed as shown in Table 2. However, when the National Severe Storm Forecast Center at Kansas City perceived a severe weather threat, they placed GOES in a rapid interval scanning operation (RISOP) during which time imagery at more frequent intervals than the normal 30 minutes were taken, as shown in Table 3. When RISOP was implemented, it was not possible to receive VAS data and VAS operations ceased. This year, for the first time, NESDIS operated RISOP in a 5-minute interval imaging mode. This does not mean continuous 5-minute interval images but rather sequences of 5-minute images within the half hourly data streams (refer to Table 3).

There were two avenues of satellite data input into the PRE-STORM field program control facility. One was the normal hardcopy laserfax data from the Weather Service Forecast Office. The other was routine GOES imagery and VAS products displayed on a personal computer (PC) workstation located in the PRE-STORM operations support facility. Products available on the PC workstation included half-hourly visible and infrared imagery, two-hourly water vapor imagery, and a number of derived VAS sounding products.

Three visible sectors were available as half-tone products. However only one sector was available during a given day. An example of the areas covered by the three sectors is included in Section 3. Sounding data products were available at 11Z, 14Z, 17Z and 20Z through coordination with the ASPP. Retrievals covered the entire PRE-STORM area, see Section 4. Both infrared and water vapor imagery were available as four-bit digital sectors: examples of the areas covered by those sectors are also provided in Section 3. The PC workstation was capable of deriving a variety of thermodynamic parameters from

Table 2. GOES Schedule with VAS

<u>Time</u>	<u>PDL</u>	<u>Activity (Channels)</u>
1000 GMT	71	7-10, (Full Disc)
1030 GMT	75, 72	7-10, DS(N)
1100 GMT	75, 74	7-10, DS(S)
1130 GMT	87, 70	10-7-12, DI(N)*
1200 GMT	71	7-10, (Full Disc)
1230 GMT	77,70	7-12, DI(N)
1300 GMT	75, 76	7-10, DI(S)
1330 GMT	75, 72	7-10, DS(N)
1400 GMT	75, 74	7-10, DS(S)
1430 GMT	75, 70	7-10, DI(N)
1500 GMT	71	7-10, (Full Disc)
1530 GMT	77, 70	7-12, DI(N)
1600 GMT	75, 76	7-10, DI(S)
1630 GMT	75, 72	7-10, DS(N)
1700 GMT	75, 74	7-10, DS(S)
1730 GMT	87, 70	10-7-12, DI(N)
1800 GMT	71	7-10, (Full Disc)
1830 GMT	77, 70	7-12, DI(N)
1900 GMT	75, 76	7-10, DI(S)
1930 GMT	75, 72	7-10, DS(N)
2000 GMT	75, 74	7-10, DS(S)
2030 GMT	75, 70	7-10, DI(N)
2100 GMT	71	7-10, (Full Disc)
2130 GMT	75, 79	7-10, 3-4-5
2200 GMT	85, 79	3-4, 3-4-5
2230 GMT	75, 72	7-10, DS(N)
2300 GMT	75, 74	7-10, DS(S)
2330 GMT	87	10-7-12,
0000 GMT	71	7-10, Synoptic (Full Disc)
0030 GMT	77, 70	7-12, DI(N)
0100 GMT	75, 76	7-10, DI(S)
0130 GMT	75, 72	7-10, DS(N)
0200 GMT	75, 74	7-10, DS(S)
0230 GMT	75	7-10, DS(S)
0300 GMT	NORMAL VISSR	

DI - Dwell Image

DS - Dwell Sound

(N) - North

(S) - South

*VISSR S/DB - Moisture Channel Support

Table 3. 1985 GOES-6 RISOP Schedule

<u>GMT</u>	<u>LINES</u>	<u>GMT</u>	<u>LINES</u>	<u>GMT</u>	<u>LINES</u>	<u>GMT</u>	<u>LINES</u>
0000	FD	0600	FD	1200	FD	1800	FD
0030	1200	0630	1200	1230	1200	1830	1200
0044	450	0644	450	1244	450	1844	450
0049	450	0649	450	1249	450	1849	450
0054	450	0653	450	1254	450	1854	450
0100	1200	0700	1200	1300	1200	1900	1200
0114	450	0714	450	1314	450	1914	450
0119	450	0719	450	1319	450	1919	450
0124	450	0724	450	1324	450	1924	450
0130	1200	0730	1200	1330	1200	1930	1200
0144	450	0744	450	1344	450	194	450
0149	450	0749	450	1349	450	1949	450
0154	450	0754	450	1354	450	1954	450
0200	1200	0800	1200	1400	1200	2000	1200
0214	450	0814	450	1414	450	2014	450
0219	450	0819	450	1419	450	2019	450
0224	450	0824	450	1424	450	2024	450
0230	1200	0830	1200	1430	1200	2030	1200
0244	450	0844	450	1444	450	2044	450
0249	450	0849	450	1449	450	2049	450
0254	450	0854# (deleted)		1454	450	2054	450
0300	FD	0900	FD	1500	FD	2100	FD
0330	1200	0930	1200	1530	1200	2130	1200
0344	450	0944	450	1544	450	2144	450
0349	450	0949	450	1549	450	2149	450
0354	450	0954	450	1554	450	2154	450
0400	1200	1000	FD	1600	1200	2200	1200
0414	450	(grid		1614	450	2214	450
0419	450	tape)		1619	450	2219	450
0424	450			1624	450	2224	450
0430	1200	1030	1200	1630	1200	2230	1200
0444	450	1044	450	1644	450	2244	450
0449	450	1049	450	1649	450	2249	450
0454	450	1054	450	1654	450	2254	450
0500	1200	1100	1200	1700	1200	2300	1200
0514	450	1114	450	1714	450	2314	450
0519	450	1119	450	1719	450	2319	450
0530	900*	1130	900*	1730	900*	2330	900*
0544	450	1144	450	1744	450	2344	450
0549	450	1149	450	1749	450	2349	450
0554	450	1154	450	1754	450	2354	450

* - 6.7 micron water vapor imagery. Third 450-line image before water vapor cancelled for manual S/DB reconfiguration.

- 0854Z image deleted for daily SOCC scanner torque test.

Target start scan line for 450 line images will be fixed at scan line number 130.

the VAS sounding data, developing statistics concerning anvil characteristics from the infrared data, animating image data with six frame loops, and displaying the cursor's location for an infrared image.

The purpose of this report is to describe activities at CIRA directed towards satellite support of the field phase of the Oklahoma/Kansas PRE-STORM experiment. Several activities were involved in this support. They included:

- 1) Development of an operational personal computer (PC) workstation to supply routine meteorological satellite products to the Oklahoma/Kansas PRE-STORM Operations Center;
- 2) Development of image display and analysis products on the PC workstation;
- 3) Development of VAS data products for use on the PC workstation;
- 4) Delivery of the PC workstation to the Oklahoma/Kansas PRE-STORM Operations Center and manning it during the field phase of the experiment; and
- 5) Archival of data received at the PC workstation for retrospective analysis.

How these activities came to fruition, along with preliminary plans for follow-on research, is described in the sections that follow. Major portions of the work reported in this document were supported by NOAA Grants NA84AA-H-00020 the NOAA Operational VAS Assessment Program, and NA84AA-D-00017 the NOAA Severe Weather Prediction Initiative.

2. Personal Computer Workstation for Satellite Data -
Input to the PRE-STORM Operations Center, Robert N. Green

A Personal Computer (PC) workstation was used as an inexpensive method of delivering GOES satellite imagery (visible, infrared and water vapor) and GOES/VAS sounding retrievals to the PRE-STORM Operations Center at Oklahoma City. The real-time data flow supported both the 24-48 hour forecasts for project planning and very short range forecasting for aircraft flight operations. In this section a brief description is given of the hardware and software of the workstation, and a "walk-through" of the various menus which make up the user interface.

The microcomputer-based meteorological research workstation has been in development over the past two years through a joint effort among the NOAA/NESDIS Development Laboratory, Space Science and Engineering Center at University of Wisconsin and the Cooperative Institute for Research in the Atmosphere at Colorado State University (Dedecker, et al, 1985). The hardware components are based on the IBM series of personal computers with peripherals of various manufacturers.

The base processor is an IBM PC/XT with a ten megabyte hard disk, 640k bytes of memory and a numeric processor to increase floating-point calculations speed (see Fig. 1). Two video monitor displays are used: 1) a monochrome screen which provides the text display for menus and alpha-numeric data, and 2) a color screen for graphical displays and imagery presentation. A dot matrix printer provides the capability of hardcopy of products displayed on either screen. Data transfer from the mainframe computer utilizes a 1200 baud automatic-dial modem connected to a standard telephone line.

Although unmodified hardware is used in the workstation, several additional resident system assembly language routines were written to supplement the standard PC operating system. New features include control for twin display monitors, parameter storage for passing information among different applications programs, and provisions for animation of satellite image graphics. Three different color graphic resolutions are available in the workstation for data display: 1) low resolution -- 100 rows of 160 elements with 16 colors displayable; 2) medium resolution -- 200 rows of 320 elements with 4 colors displayable; 3) high resolution -- 200 rows of 640 elements with a pixel either on or off. Up to 24 of these graphics may be stored in system memory to provide

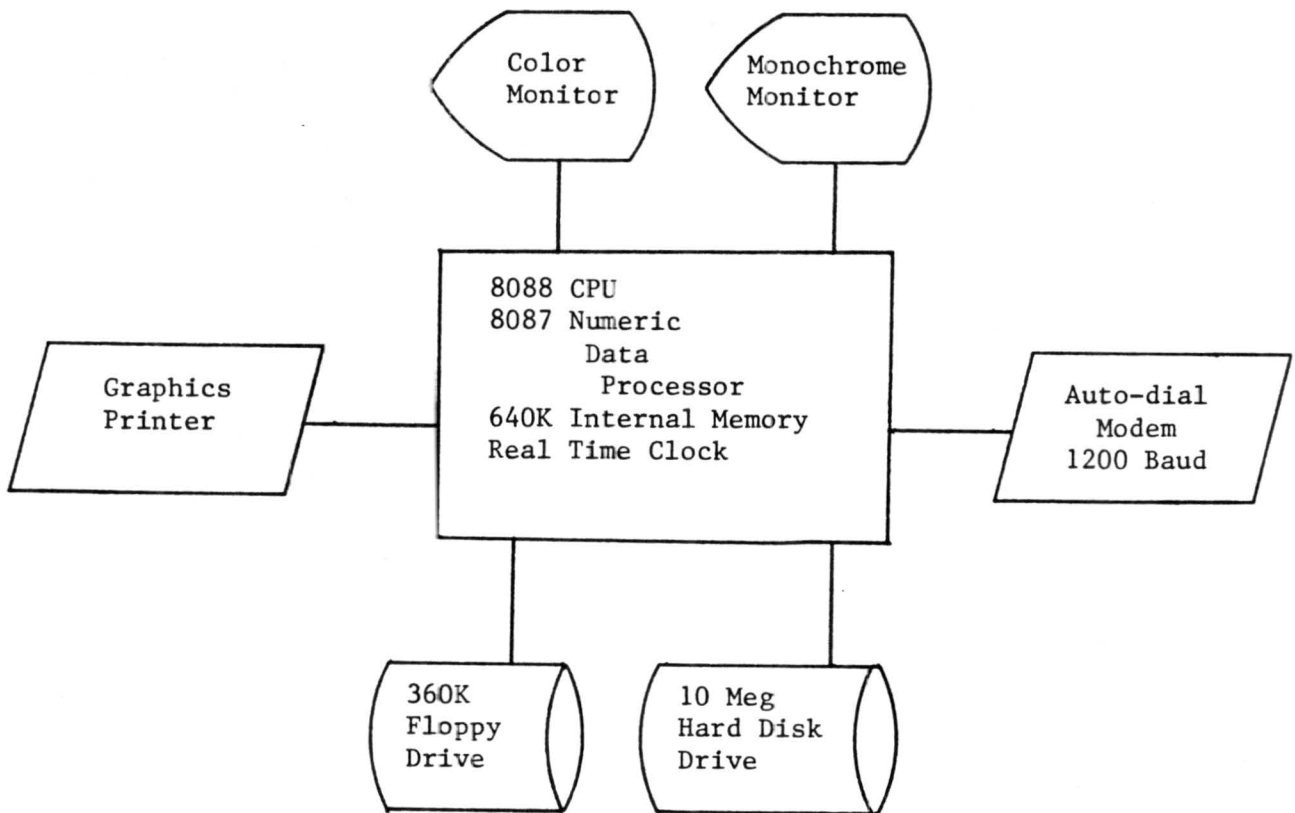

Figure 1. System Configuration Schematic Diagram of the CIRA/RAMM Branch PC Workstation used in the PRE-STORM Operations Center.

for animation with user definable looping rates up to 15 frames per second.

The applications programs for communications, image display, and VAS retrieval processing are written in Pascal and FORTRAN for efficient data processing. A menu driven system was chosen as the user interface to minimize keyboard input. Program selection is by function keys, data file selection is by number in a list, and program control is by single letter commands. Access to the mainframe data base features automatic dial, log on, data transfer and log off to further lessen the need of the user to be knowledgeable of computer details.

Realtime satellite data were required to support the PRE-STORM Operations Center during mission flight days. A scheduler program was written to read a list of products and associated acquisition times and automatically transfer these from the mainframe database. This unattended product transfer allowed the meteorologist to provide forecasting support and handle other duties and yet be assured that the most current data would be readily available.

Because the standard personal computer is a single-user, single-task processor, two PC's were used at PRE-STORM. Both had identical hardware and software, but at power-up each day the meteorologist could choose one to be the dedicated automatic scheduler and the other to be the interactive workstation. The scheduler system allowed the workstation to be used for forecasting and analysis support nearly full time. As new products were acquired, the data were transferred between systems by using floppy diskettes. The two computer arrangement also provided another operational requisite - redundancy. The product access and file update software was designed to optimally work in a two-computer mode; however, all data products were able to be manually acquired and all workstation analysis tools maintained in a one-computer system

configuration. Operational support could be continued even with one system failure.

Image animation is an important tool for a satellite meteorologist. The workstation software was designed to loop the six most current images of visible, infrared and water vapor data. Since all 18 images were stored in memory, one could instantly switch among the three types of loops by pressing one key. Each loop could be customized as to looping rate and beginning and ending dwell and to eliminate a frame that may be incorrect.

A schematic diagram of the menu structure is presented in Figure 2 to show the flow of interactivity of the various operations which could be performed. Such a structure provided to the meteorologist all of the procedures available in a logical progression without the need to type long operating system commands or file names. Figures 3.1 to 3.13 show the various menus in the workstation.

To review the programs available to the meteorologist at PRE-STORM, a more detailed description of each menu follows. Upon power-up of the computer equipment at the start of the day (or after a power failure), the PC automatically executes several programs to initialize the workstation software. The final step is to present the menu in Fig. 3.1, the master menu for the PRE-STORM system. Two completely different configurations are available - workstation or communications. One of three predefined product lists may be activated with the communications configuration so that the automatic scheduler would be initialized for a full schedule, a partial schedule for informal viewing during a down day, or a special schedule when VAS data were not being collected. Once the scheduler is activated, all product acquisition is automatic with the transfer of new products from the communications PC being triggered by either a schedule entry or a special key-in by the user.

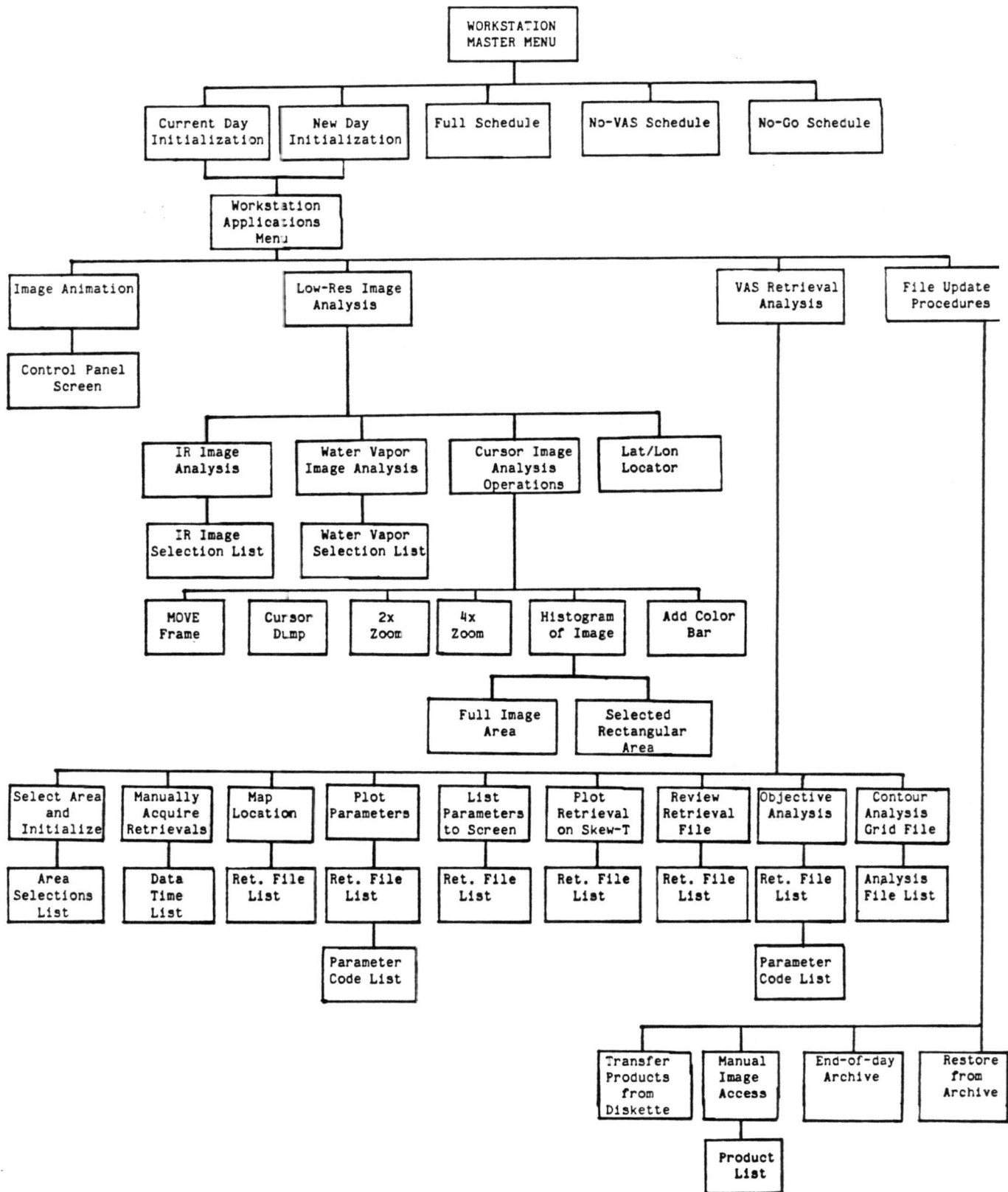

Figure 2. Menu Structure for the PRE-STORM Workstation Software.

The other configuration shown in Fig. 3.1 is for the analysis workstation with two choices of initialization. The "new day" selection deletes all image and retrieval files from the hard disk to make room for the new products. If the system is being restarted during the day, "current day" is selected. "Current day" automatically loads the image loops without deleting data that is on the hard disk.

Four major categories of operations are available once the workstation initialization is completed (Fig. 3.2). The PRE-STORM configuration allowed for three 6-frame loops of visible, infrared and water vapor imagery to be stored in internal memory with an additional six frames for other uses. The image animation function is controlled by a "display control" program (see Fig. 3.3) which allows the user to interactively switch to different loops and modify dwell loop limits.

SATELLITE DATA WORKSTATION	
MASTER MENU	
KEY	ACTION
F1.	Forecast Workstation Configuration (Current Day)
F2.	Forecast Workstation Configuration (New Day)
F3.	Communications Configuration (Full Schedule)
F4.	Communications Configuration (Down Day Schedule)
F5.	Communications Configuration (Special Schedule)

Please press the function key (F1..F5) of your choice,
or press "ESC" to exit to DOS.

Figure 3.1. Satellite Data Workstation

PRESTORM SATELLITE OPERATIONS MENU

KEY	ACTION
F1.	Image Animation
F2.	Image Analysis (Low Res Mode)
F3.	Retrieval Analysis
F4.	File Update Procedure

Please press the function key (F1..F4) of your choice,
or press "ESC" to exit.

Figure 3.2. PRE-STORM Satellite Operations Menu

DISPLAY CONTROL INSTRUCTIONS

SEQ. NUM.	FRAME NUM.	DWELL LEN.	NAME	ISEQ. INUM.	FRAME NUM.	DWELL LEN.	NAME
1	0	4	JN145213	1	6	6	JN155023
2	1	0	JN145220	2	7	2	JN155030
3	2	0	JN145223	3	8	2	JN155033
4	3	0	JN145230	4	9	2	JN155043
5	4	0	JN145233	5	10	2	JN155050
6	5	4	JN155000	6	11	4	JN155060
				(VIS) F1		(IR) F2	
1	12	4	JN135213	1	18	0	BLANK
2	13	2	JN145113	2	19	0	BLANK
3	14	2	JN145133	3	20	0	BLANK
4	15	2	JN145143	4	21	0	JN155050
5	16	2	JN145233	5	22	0	COMPLETE Pr
6	17	6	JN155053	6	23	0	SKEN T-LOG P
				(MV) F3		F4	

A = ADVANCE ONE SEQUENCE; B = BACKUP ONE SEQUENCE; ESC = QUIT;
L = LOOPING TOGGLE (on/off); I = LOAD/SAVE IMAGE/FRAE CONTENTS;

TO CHANGE SEQUENCE DEFINITIONS, POSITION THE CURSOR TO PARAMETER TO BE CHANGED
AND ENTER NEW PARAMETER. ENTER AN "X" TO DISABLE A SEQUENCE LIST ITEM.

Figure 3.3. Display Control Instructions

The "image analysis" section (Fig. 3.4) provides tools to display the low resolution mode (160 x 100 x 16 color) infrared and water vapor images and to perform elementary analysis.

"IR Image Display" -

A routine to present to the user a list of currently available infrared low-res images and to allow selection via a number input (Fig. 3.5). No file name memorization is required to access the images.

"Water Vapor Image Display" -

The routine is the same as the previous except for the data type.

"Cursor and Analysis Operations" -

This selection presents a menu (Fig. 3.6) of options for use with the low-res image which has already been chosen.

"Move Frame to Screen" -

restores the graphic screen back to the original image.

"Activate Cursor and Dump Image" -

adds a software generated cross-hair cursor to the image; allows the arrow keys on the keypad to move the cursor, and prints out on the monochrome screen the screen coordinates and the four-bit count value.

"Zoom Image by Factor of 2" -

activates the cursor control so that the center of the region to be expanded two times by bilinear interpolation may be interactively chosen.

"Zoom Image by Factor of 4" -

expands image by four times.

"Display Histogram and Statistics" -

calculates histogram and statistics of either the complete image or an interactively chosen rectangular area and displays results on the monochrome screen (see Fig. 3.7).

"Add Color Bar..." -

adds an annotated color bar to the bottom of the image to show the color relationships to the user.

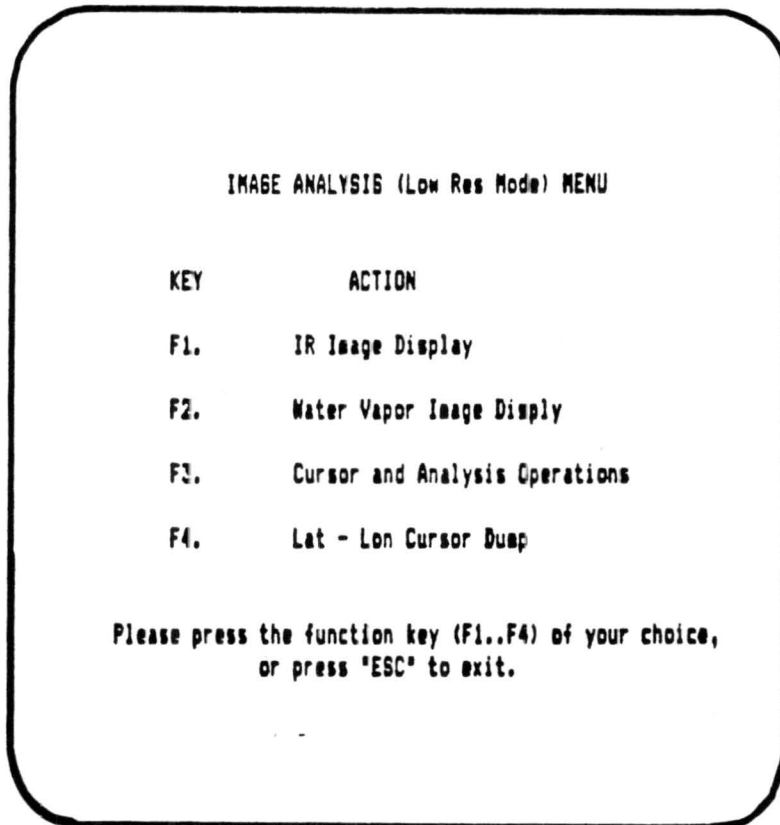

Figure 3.4. Image Analysis (Low Res Mode) Menu



Figure 3.5. IR Image Selection

The last entry in Fig. (3.4), "Lat-Lon Cursor Dump", was added for PRE-STORM image products to provide a rough estimate of the latitude-longitude coordinates of the cursor location on the images and also the temperature range of the count value at that point (see Fig. 3.8).

The third item in the Operations Menu (Fig. 3.2) presents a menu (in Fig. 3.9) of VAS retrieval analysis operations and manual file acquisition from the mainframe.

"Select Area and Initialize Code" -

From a list of pre-defined geographic areas (see Fig. 3.10), the user selects by number the currently required region. The background map is created and stored in memory for future use, greatly increasing the speed of the other applications programs.

CURSOR/IMAGE OPERATIONS MENU	
KEY	ACTION
F1.	Move Frame to Screen
F2.	Activate Cursor and Dump Image
F3.	Zoom Image by Factor of 2
F4.	Zoom Image by Factor of 4
F5.	Display Histogram and Statistics
F6.	Add Color Bar for Displayed Image

Please press the function key (F1..F6) of your choice,
or press "ESC" to exit.

Figure 3.5. Cursor/Image Operations Menu

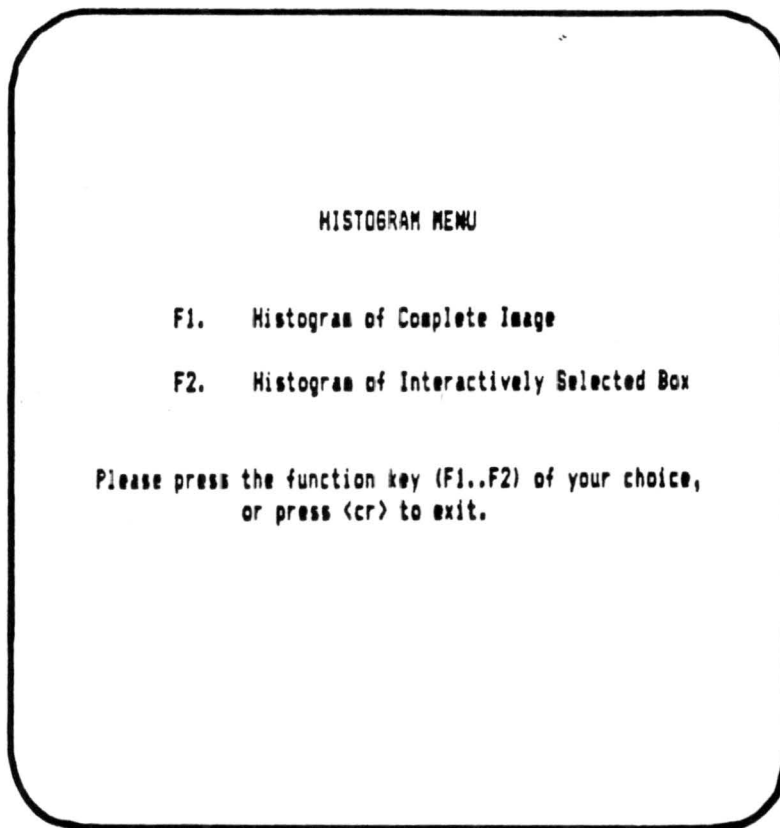

Figure 3.7. Histogram Menu

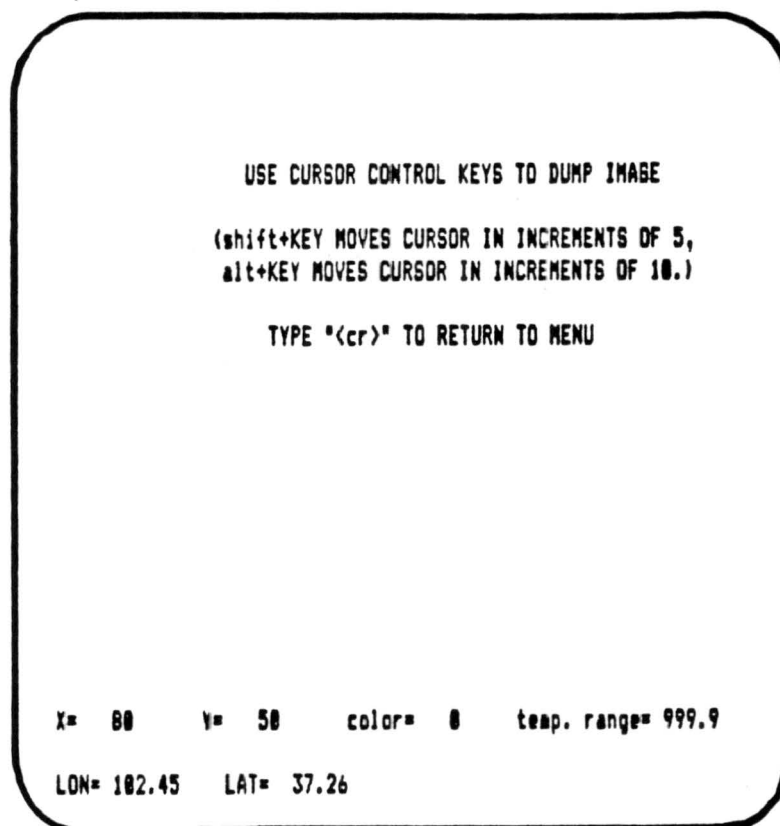

Figure 3.8. Cursor Operations to Dump Image

VAS RETRIEVAL ANALYSIS MENU	
KEY	ACTION
F1.	Select area and initialize code
F2.	Acquire and process retrievals
F3.	Locate retrievals on map
F4.	Show retrieval parameters on map
F5.	List retrieval parameters to screen
F6.	Plot retrievals on skew-T,log-P
F7.	Review retrieval file
F8.	Objectively analyze parameters
F9.	Contour analysis file

Please press the function key (F1..F9) of your choice,
or press "ESC" to exit.

Figure 3.9. VAS Retrieval Analysis Menu

LIST OF AREAS FOR GRAPHICS INITIALIZATION	
1	SECTOR A Pre-STORM NORTH
2	SECTOR B Pre-STORM CENTRAL
3	SECTOR C Pre-STORM SOUTH
4	SOUTHEASTERN US
5	AIMCS PROJECT AREA
6	COMPLETE Pre-STORM AREA

Enter ID number of area required (1- 6), or "B" to exit :

Figure 3.10. List of Areas for Graphics Initialization

"Acquire and Process Retrievals" -

A list of VAS product times are presented (see Fig. 3.11). Once selection has been made, the data acquisition and processing continue in an automatic mode. The manual access mode was added to provide flexibility to data acquisition if the scheduler was down or running behind schedule.

"Locate Retrievals on Map" -

All retrievals for a given time period are plotted on a background map with a sequence number placed at its latitude-longitude position. The sequence number may be used to access a specific retrieval in other programs. Figure shows an example of the graphics output of this routine.

"Show Retrieval Parameters on Map" -

A graphic display similar to the previous program's output is generated with the sequence number being replaced by a VAS retrieval parameter chosen by the user from a menu table. A hardcopy of this display may be hand-analyzed.

MENU FOR MANUALLY ACQUIRED RETRIEVAL FILES	
Not all time periods may be available	
KEY	DATA TIME
F1.	1118 GMT
F2.	1318 GMT
F3.	1418 GMT
F4.	1718 GMT
F5.	2018 GMT
F6.	2318 GMT
F7.	TOVS Retrievals

Please press the function key (F1..F7) of your choice,
or press "ESC" to exit.

Figure 3.11. Menu for Manually Acquired Retrieval Files

"List Retrieval Parameters to Screen" -

The data for the complete retrieval may be displayed in a text format on the monochrome monitor with this program. The retrievals to be displayed are selected by either sequence number or by latitude-longitude box coordinates. A hardcopy of the text is available if the printer is activated by the "Control-Print Screen" command.

"Plot Retrievals on Skew-T, Log-P" -

A retrieval can be plotted on a skew-T, log-P background. The temperature data is plotted with a solid line, and a dashed line is used for the dew point data. The user has the option of plotting a second retrieval on the same graphic in a contrasting color for comparison analysis. This program also displays information on the monochrome screen showing various computed indices and parameters derived from the retrieval. Because of sparse availability of wind data for the VAS retrievals, some of the wind-dependent parameters are not useable. An example of this routine's graphic output is given in Section 4.

"Review Retrieval File" -

This program is available to the analyst to quickly scan a given VAS retrieval file. Each retrieval is plotted on the skew-T, log-P background, erased and the next plotted as rapidly as possible. The intent of the process is to quickly do a quality control check of a complete file, and to obtain an idea of the make-up of the VAS retrievals.

"Objectively Analyze Parameters" -

A retrieval file can be objectively analyzed with a two-pass Barnes technique. Due to program size limitations, the routine is limited to a file size of 125 observations and an output grid dimension of 16 x 11 one degree longitude-latitude points. The execution time is about two to six minutes. The output of this routine is a gridded file which can be used by other programs. Due to long execution times and problems with technique's handling of VAS retrieval spacing, the use of program during PRE-STORM was very limited.

"Contour Analyzed Field" -

The output file from the analysis program can be displayed in a contoured format in the medium resolution graphic mode. Up to three different fields may be displayed at once with the three different colors available. The contoured field is displayed on a geographic background.

The final category of operations in Operations Menu (Fig. 3.2) is "File Update Procedures". The menu in Fig. 3.12 presents four file handling activities required during daily operations.

"Transfer of Products from Diskette" -

Once a new set of products have been collected by the communications system and written to floppy diskettes, this procedure is activated to copy the files to the hard disk, update all directory listings and reload the most recent six images in each data type. All processing in this routine is automated, requiring no input from the analyst except for loading the diskettes when prompted.

"Manual Image and Graphic Product Access" -

The ability to manually acquire image products was also included in the workstation software, as was manual VAS retrieval access. The most recent image products (see Fig. 3.13) could be received, displayed and added to the current data base by one function key hit. This procedure was used only in special situations during PRE-STORM.

"End of Day Archive Processing" -

An automated procedure was used to archive the complete PC data base for a given day's operations. One of the duties of the satellite meteorologist was to insure that all satellite products acquired and used during the PRE-STORM project were archived on diskettes on a daily basis. The archive processing was automated with the meteorologist being prompted to change diskettes.

PRODUCT TRANSFER MENU

KEY	ACTION
F1.	Transfer of Products from Diskette
F2.	Manual Image and Graphic Product Access (telephone)
F3.	End of Day Archive Processing
F4.	Restore a Previous Day of Archived Data

Please press the function key (F1..F4) of your choice,
or press "ESC" to exit.

Figure 3.12. Product Transfer Menu

"Restore a Previous Day of Archived Data" -

A procedure was written to load an archived data set for a given day or event back into the PC. All old data files are deleted before the archived files are restored from diskettes. All data base directory lists are updated and the system initialized, ready for the meteorologist to analyze any of the data.

Through the operational use at the PRE-STORM Operations Center, the PC Workstation proved to be a feasible method of acquiring, processing and analyzing digital satellite data at a location remote from the ingest computer system. Faster transmission of data, higher resolution displays, and a speedier processor are welcome in an operational environment. However, for the costs of the PC resources, sufficiently adequate satellite data were available at the PRE-STORM center to provide good input to the exercise. Green and Weaver (1985) presents more conclusions as to the utility of the PC workstation through a case study analysis of the 6 May 1985 PRE-STORM day.

MENU FOR MANUALLY ACQUIRED PRODUCTS		
KEY	ACTION	
F1.	Most recent Visible	(halftone)
F2.	Most recent IR	(low-res)
F3.	Most recent Water Vapor	(low-res)
F4.	Most recent Precipitable Water	(low-res)
F5.	Most recent Stability Index	(low-res)

Please press the function key (F1..F5) of your choice,
or press "ESC" to exit.

Figure 3.13. Menu for Manually Acquired Products

3. Display and Analysis of Image Products on the IBM-PC Workstation,
James F.W. Purdom

Satellite image data were available to the PRE-STORM Operations Center Personal Computer workstation on a routine basis. This included GOES visible, infrared and water vapor imagery. Series of those images were available for animation using the display control menu shown in Figure 3.3.

On a given day, visible imagery were available for one of the three sectors shown in Figure 4. Visible images were displayed as half-tone products, an example of which is shown in Figure 5. While those products were not of the high resolution with which many of the PRE-STORM participants were accustomed, they were capable of depicting major organized cloud patterns as well as areas of growing cumulus and some outflow and frontal boundaries. In Figure 5, for example, boundaries due to prior convection are detectable in Oklahoma as well as Kansas. Organized convective bands can be seen in western Kansas and a large convective mass is evident in eastern Kansas. Intense thunderstorms, some with severe weather were reported later in the day in western Kansas near where the pre-existing boundaries interacted with the developing convective bands. It should be noted that the ability to animate this half-tone visible product greatly enhanced its utility.

Water vapor imagery were normally available at 2-hourly intervals (VAS satellite operations) or at 6-hourly intervals (RISOP satellite operations). The 6.7 μm water vapor channel detects radiation from the middle portions of the atmosphere, see Table 1, with transmission determined by the distribution and temperature of the water vapor in the middle levels. Imagery from this channel often shows distinct moist and dry patterns which are the result of atmospheric vertical motion and advection. Synoptic scale features such as jet streams,

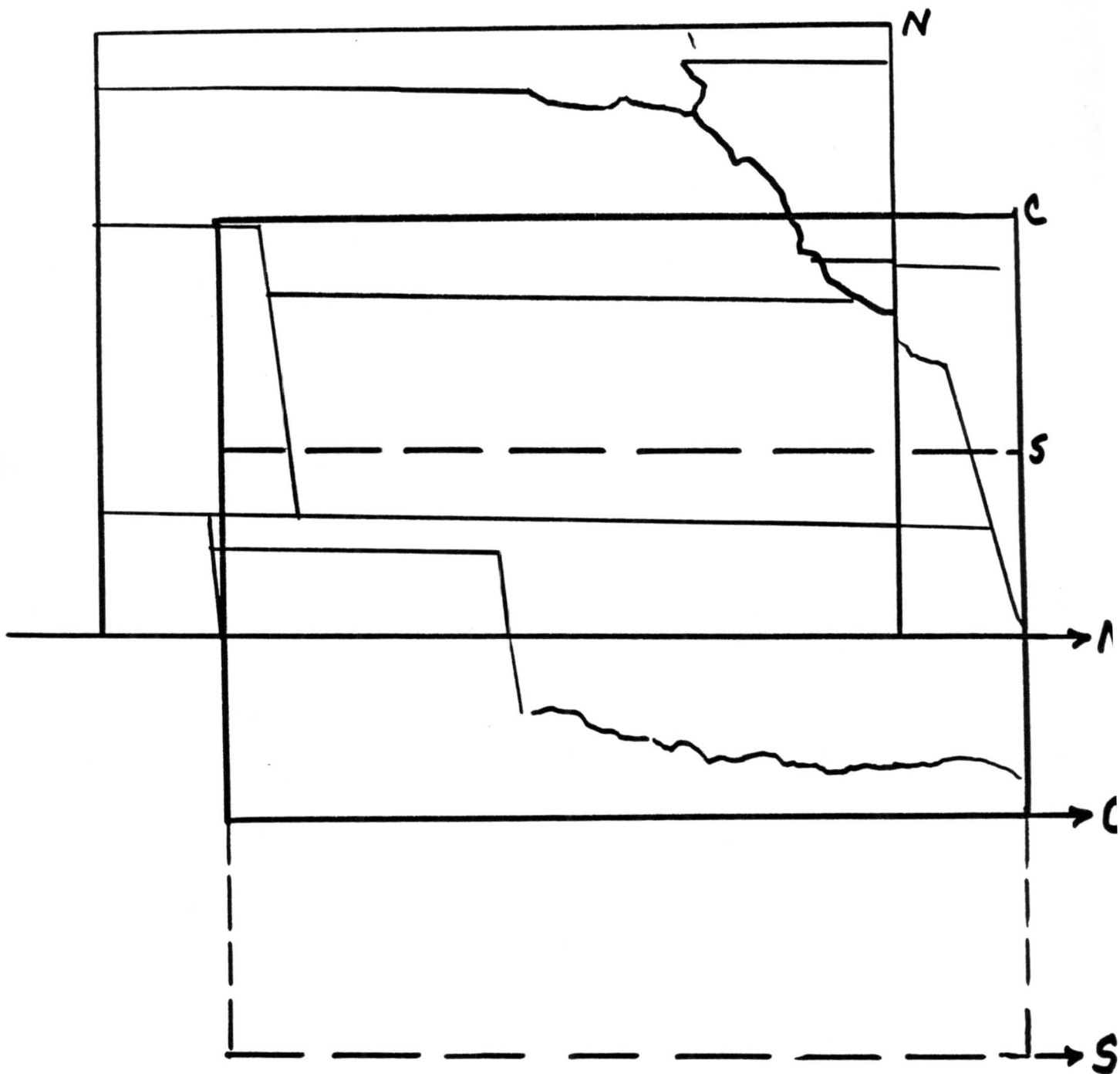

Figure 4. Areas covered by PRE-STORM sectors. North (N), Central (C), and Southern (S). The Northern and Southern boundaries of the S sector are dashed. The N sector is offset from C and S in an East-West direction.

upper level lows and short waves can often be identified in areas where there are no middle or high level clouds. Drying at mid-levels, in response to compensating subsidence in the vicinity of developing thunderstorms, was also detectable in the 6.7 μm imagery during PRE-STORM.

The water vapor images produced for PRE-STORM covered the area shown in Figure 6a. The resolution of an individual water vapor picture element is approximately 12km by 25km. Referring to the color bar on the bottom of the image in Figure 6a, dry to moist runs from level 1 (driest) to level 15 (most moist/cloud). In general terms, the lowest three shades (1, 2 and 3) are very dry, the upper four shades (12 through 15) are cloudy, and the remaining shades (4 through 11) correspond to varying amounts of water vapor in the middle portions of the atmosphere. Figure 6a is from the June 10-11 PRE-STORM operational day. Several interesting features are evident in that water vapor image. The large dark area centered in the western Nebraska panhandle is a

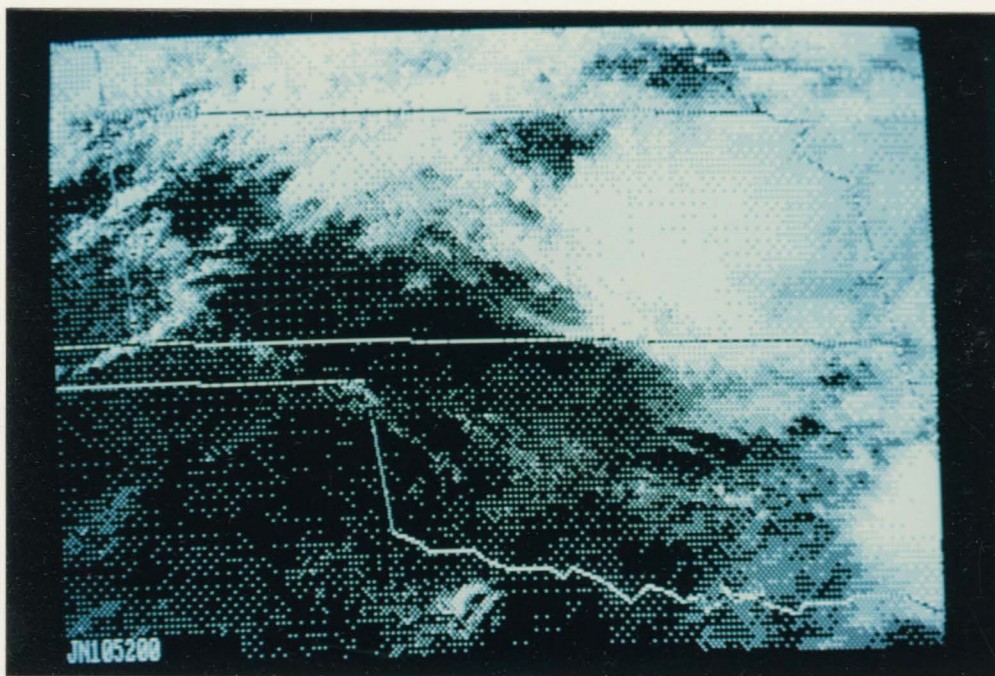

Figure 5. Half-tone VIS image from 10 June 1985 at 2000 GMT.

reflection of drying and subsidence with a strong short wave moving to the north of the PRE-STORM area. Over a six hour period, this feature had moved from western Wyoming to its current location - a speed of approximately 50 nautical miles per hour. On this day, a strong mesosystem moved through Kansas and into Oklahoma with intense convection and strong straight line winds along its leading edge. In Figure 6a, the massive moist regions in Kansas and southeast Colorado are due to the intense thunderstorms: note the very dry air immediately to their south and southwest. Water vapor imagery taken six hours earlier (this was a RISOF day) showed the elongated dry tongue extending across southern Arizona and New Mexico and into the Texas panhandle, in Figure 6b. With water vapor data available at only six hour intervals, it is not possible to tell if any mid-level drying occurred in response to the strong convective storms. However, the drying in advance of the squall line and the strong straight line winds that occurred with that squall line lead to a number of intriguing questions concerning convective response and the role of dry air entrainment in squall line organization, to name but a few.

Infrared imagery were available at hourly or half hourly intervals during the PRE-STORM program depending on the time of day, refer to the schedule shown in Table 3. The infrared images produced for PRE-STORM covered the area shown in Figure 7. Resolution of an individual picture element is approximately 9km by 19 km. Since the infrared data were received in digital form, exact temperature ranges could be assigned to each infrared picture element. Table 4 shows the temperature range covered by each of the sixteen available digital increments. Notice in that table, that the colder temperature ranges have higher thermal resolution while the warmer temperature ranges have less and less thermal resolution. The various temperature ranges shown in Table 4 correspond

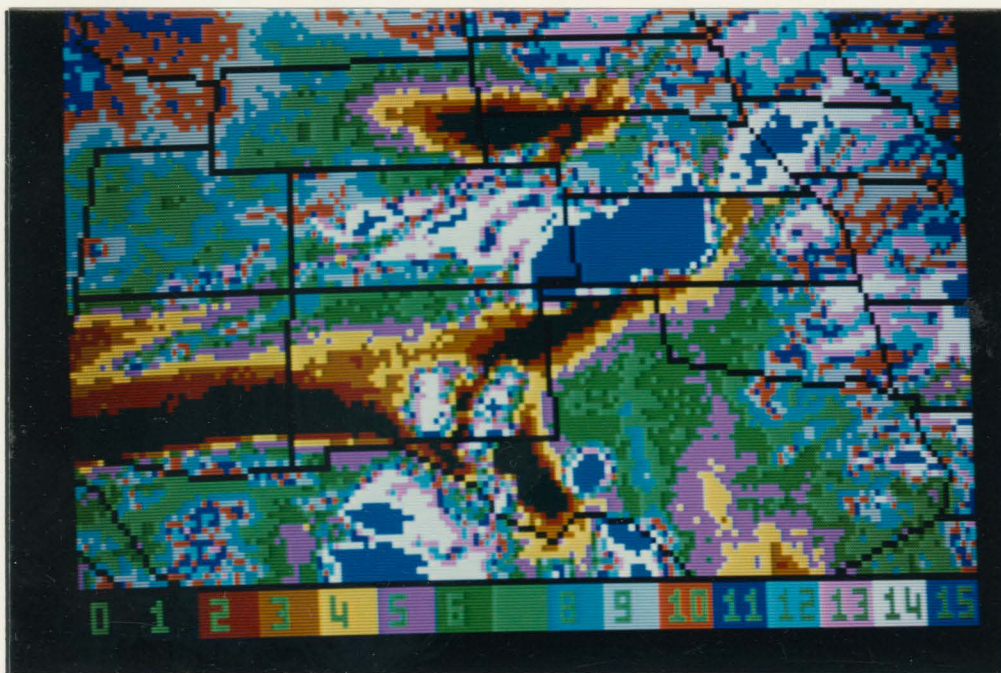

Figure 6a. 6.7 μm water vapor imagery from 10 June 1985 at 2300 GMT.

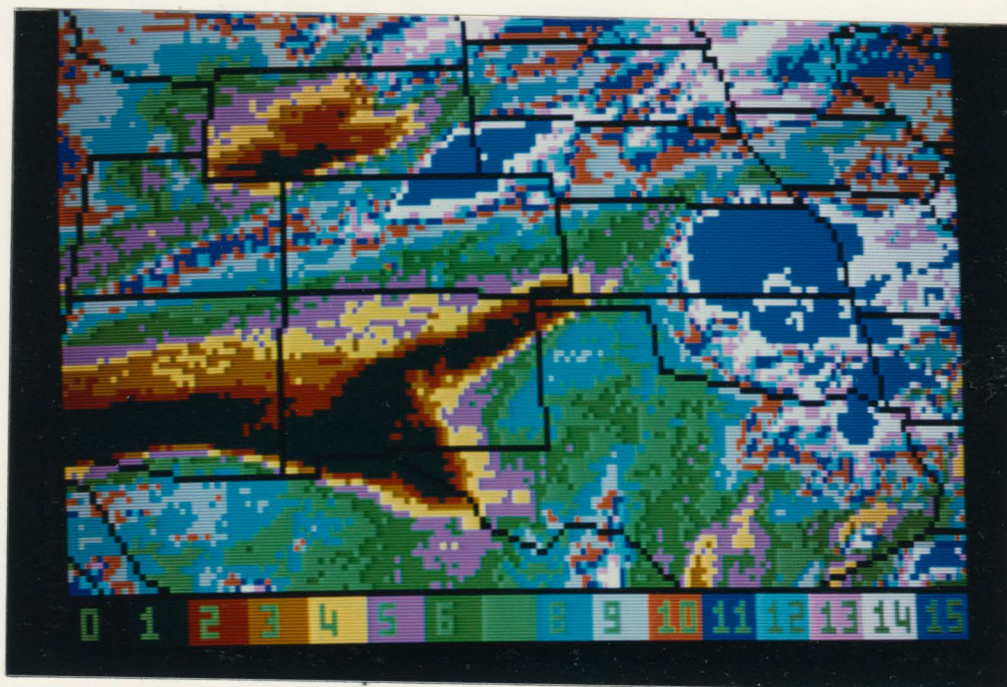

Figure 6b. 6.7 μm water vapor imagery from 10 June 1985 at 1700 GMT.

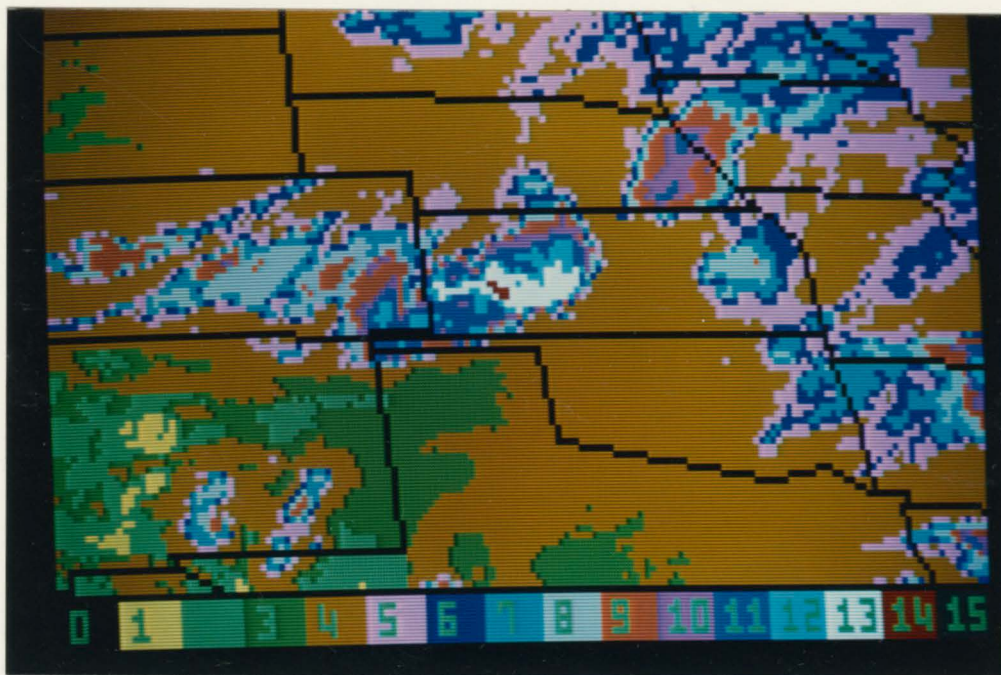

Figure 7. Infrared image from 10 June 1985 at 2300 GMT.

Table 4. PRE-STORM Temperature Ranges
versus IBM PC Colors

Color (IBM#)	Satellite Digital Count Range	Temperature Range
Black (0)	Grid	Grid
Yellow (14)	38 - 0	37.8°C and hotter
Lt. Green (10)	39 - 49	31.8°C to 37.7°C
Green (2)	60 - 50	26.8°C to 31.8°C
Brown (6)	153 - 61	-19.7°C to 27.7°C
Lt. Magenta (13)	176 - 154	-31.2°C to -19.8°C
Blue (1)	184 - 177	-39.2°C to -31.3°C
Cyan (3)	192 - 185	-47.2°C to -39.3°C
White (7)	199 - 193	-54.2°C to -47.3°C
Lt. Red (12)	204 - 200	-59.2°C to -54.3°C
Magenta (5)	207 - 205	-62.2°C to -59.3°C
Lt. Blue (9)	210 - 208	-65.2°C to -62.3°C
Lt. Cyan (11)	213 - 211	-68.2°C to -65.3°C
Hi. Int. White (15)	216 - 214	-71.2°C to -68.3°C
Red (4)	219 - 217	-74.2°C to -71.3°C
Gray (8)	220 & greater	-74.3°C and colder

to the color bar on the bottom of the image in Figure 7. Note that the cloud shield with the storm system in western Kansas shows a very cold temperature of -71.3 to -74.2°C in its central portion while a large part of the convective cloud shield is in the -63.3 to -71.2°C range. The latitude/longitude cursor dump-image routine shows that intense convection is located at approximately 100°W x 38°N . The PC system in use during the PRE-STORM field program allowed a quantitative assessment of the growth and decay of cloud shields with mesoscale systems. This was able to be done in the image analysis low-resolution mode using the display histogram and statistics option. Figure 8 is an infrared image from June 11 at 0300 GMT, taken four hours after the image in Figure 7. The box within the image indicates the area for which histogram statistics will be performed. Figure 9 shows the histogram of the cloud field within the box in Figure 8. If such a function is done on a half hourly basis, graphs of growth rates for different temperature ranges within the cirrus shield may be constructed. Such a graph is shown in Figure 10 for the June 10-11 mesoscale convective system. Through such analyses on mesoscale convective systems, it is possible to tell when certain threshold criteria (such as those for mesoscale convective complexes) have been met. It is interesting to note that the area colder than -72°C reached MCC proportions for over one hour.

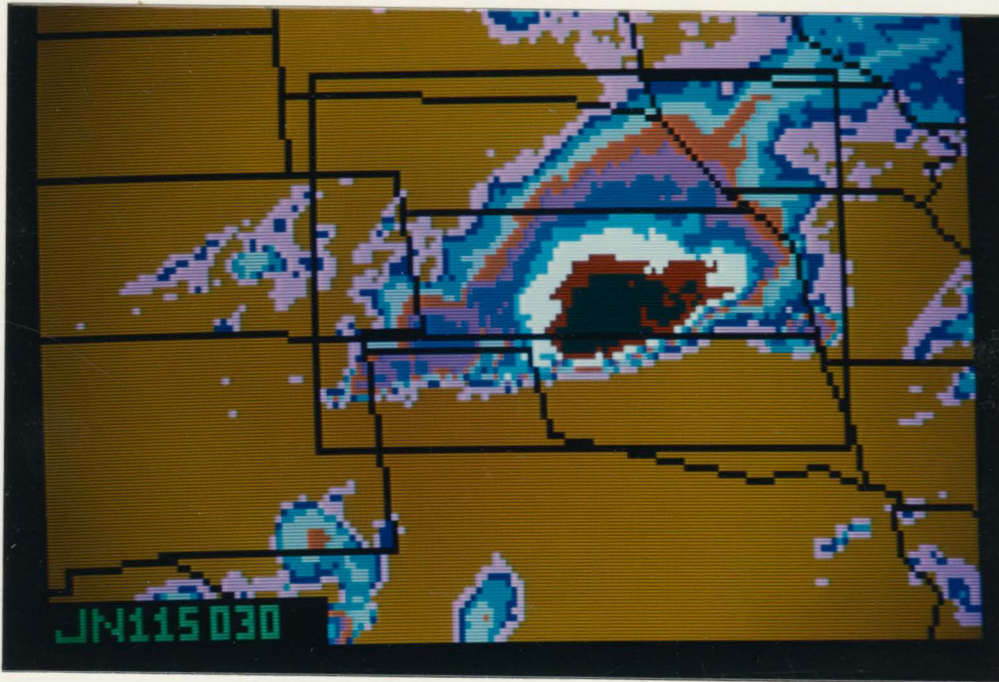

Figure 8. Infrared image from 11 June 1985 at 0300 GMT. Rectangular region indicates interactively chosen area for statistical analysis (see text).

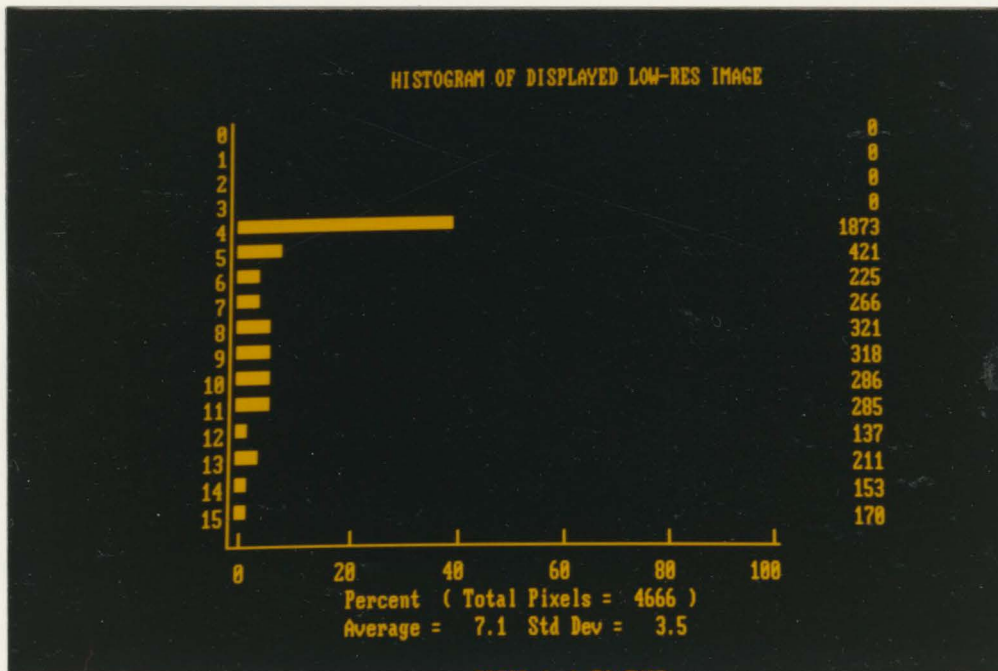

Figure 9. Histogram of brightness counts in rectangular area shown in Figure 8.

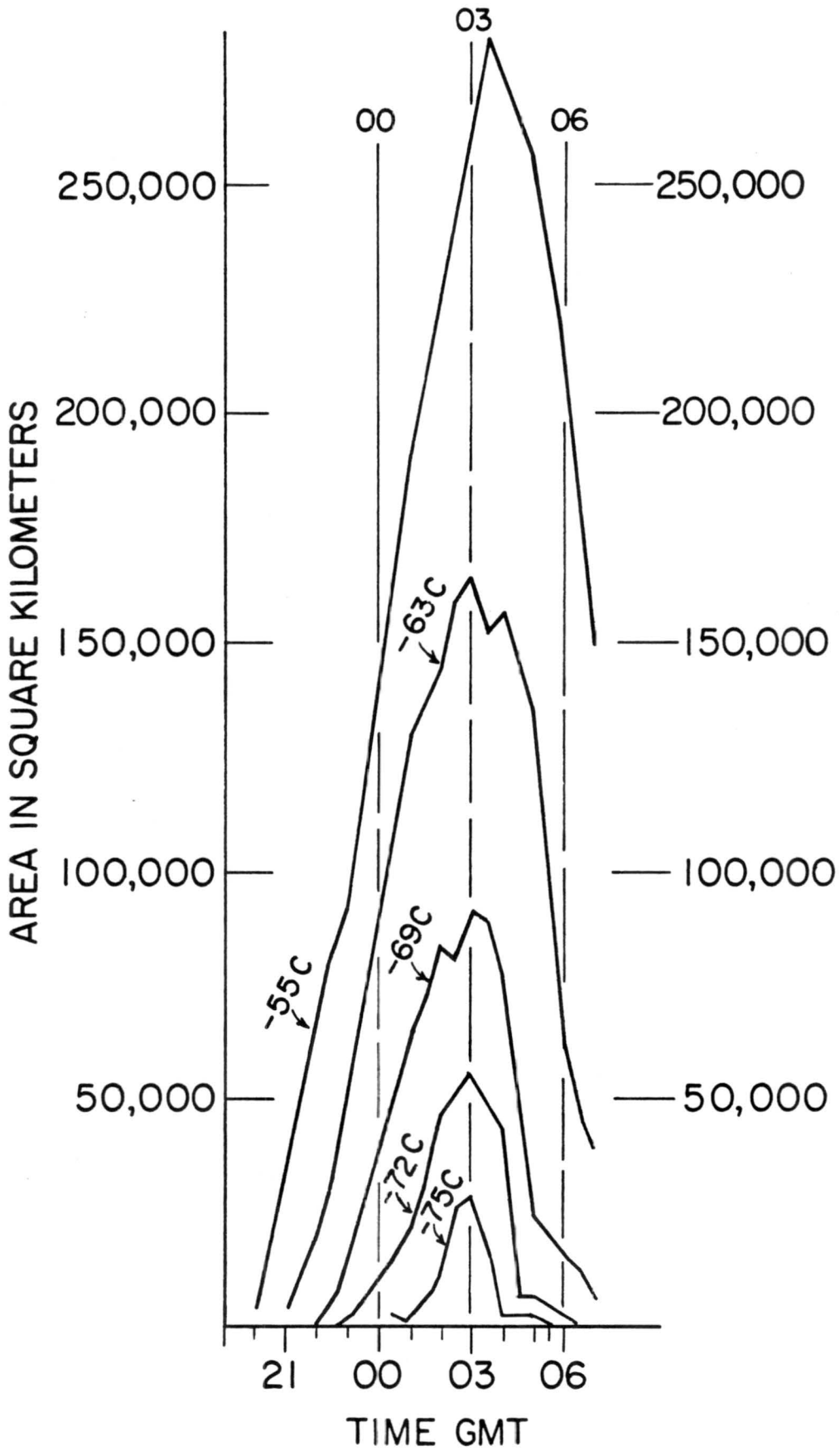

Figure 10. Growth rates for selected isotherms (area of that temperature and colder) for the June 10-11 mesoscale system.

4. Display and Analysis of VAS Retrievals on the IBM-PC Workstation, Ray Zehr

When GOES is operated in the dwell sounding (DS) mode, vertical profiles of temperature and humidity are available in cloud-free regions. The Advanced Satellite Products Project (ASPP), NESDIS, University of Wisconsin derived soundings in the PRE-STORM area and transmitted them to the IBM-PC Workstation for real-time use. The profiles (geopotential, temperature and dew point at constant pressure levels) are referred to as "retrievals" since they are "retrieved" from the twelve infrared spectral radiances measured by VAS (Table 1). The algorithm used during PRE-STORM is similar to that described by Smith (1983). During PRE-STORM, the horizontal resolution of retrievals was approximately 80 km x 80 km at three hour intervals. There were, however, serious data availability problems which are discussed later in this section.

Figure 11 shows the data and format for each retrieval. The calibrated satellite brightness temperatures in each of the VAS spectral bands in addition to the conventional state parameters and various geopotential thicknesses are available for analysis. Winds at four levels (850, 700, 500, 300 mb) computed from VAS geopotential gradients are included with some of the retrievals. The field of any parameter (temperature, dew point, wind, or height) at a constant pressure level can be displayed on the IBM-PC. These fields are depicted as a simple plot of values (Fig. 12) or an objective analysis (Fig. 13).

The sounding analysis routine on the IBM PC workstation computes various parameters applicable to thunderstorm forecasting (Table 5 and Figure 14). Much of the software is identical to that used at NSSL and PROFS and was originally designed for analysis of radiosonde observations. While modifications have been made to compute additional parameters, the original parameters have been

LAT,LON = (42.85 93.61) DATE = 85126 1713

Brightness Temepratures (°K)

224.40	222.70	224.70	237.00	272.00	261.50
294.00	30.160	256.00	239.60	.00	305.90

P(mb)	T(°K)	DP(°K)	HT(m)	DIR(DEG)	SPD(kt)
975.00	290.50	280.50	352.00	.00	.00
950.00	287.60	276.70	572.00	.00	.00
920.00	285.40	272.40	842.00	.00	.00
850.00	280.60	260.00	1499.00	299.00	11.00
780.00	276.10	253.00	2200.00	.00	.00
700.00	270.70	246.30	3067.00	289.00	18.00
670.00	268.50	244.00	3413.00	.00	.00
500.00	253.80	232.60	5652.00	286.00	30.00
400.00	242.60	232.70	7274.00	.00	.00
300.00	230.20	220.60	9266.00	.00	.00
250.00	224.70	.00	10480.00	285.00	42.00
200.00	220.30	.00	11935.00	.00	.00
150.00	215.90	.00	13772.00	.00	.00
100.00	211.30	.00	16309.00	.00	.00

Figure 11. Listing of data available from an individual retrieval file transmitted from ASPP, University of Wisconsin to IBM-PC workstation.

retained. The thermodynamic parameters, particularly those which are layer averages and thermodynamic diagram area averages are well suited for VAS observations. The wind parameters have been retained to analyze VAS data in combination with high vertical resolution wind data supplied by Profilers and rawinsondes (when available).

Research with VAS retrieval data sets prior to PRE-STORM led to the development of various products for mesoscale analysis and convective weather forecasting. Direct comparisons of VAS vertical profiles within a single data set have been shown to highlight important air mass differences. Mesoscale air mass characteristics are found to be more evident in analyses of various

Table 5. Parameters Derived from Each VAS Retrieval (continued on next page)

Type and Name	Notation	Units	PC No. and Abbreviation	Comments
PARCEL DEFINITION				
1. Lowest kilometer dew point	$\overline{DF}_{0-1 \text{ km}}$	°C	77 0-1 km DEW PT	A mass weighted average computed from all interpolated levels with heights less than 1000 meters above the surface, is used to define a parcel.
2. Lowest kilometer temperature	$\overline{T}_{0-1 \text{ km}}$	°C		
3. Lowest kilometer mixing ratio	$\overline{r}_{0-1 \text{ km}}$	gkg ⁻¹	78 0-1 km MIX RATIO	
PARCEL LEVELS				
4. Height of lifting condensation level (LCL)	Z_{LCL}	m	79 LCL HT	The LCL height, pressure, temperature, and mixing ratio are computed exactly based on parcel definition.
5. Pressure of LCL	P_{LCL}	mb	80 LCL P	
6. Temperature of LCL	T_{LCL}	°C	81 LCL TEMP	
7. Mixing ratio of LCL	r_{LCL}	gkg ⁻¹	82 LCL MIX	
8. LFC (level of free convection) pressure	P_{LFC}	mb	83 LFC P	The pressure level of the LFC, EL, and CCL are computed as the first interpolated level above their actual level. Therefore, there is an error of $\pm \Delta Z$, where ΔZ = interpolation increment.
9. EL (equilibrium level) pressure	P_{EL}	mb	84 EL P	
10. CCL (convective condensation level) pressure	P_{CCL}	mb	85 CCL P	The CCL is defined by the intersection of the lowest kilometer mixing ratio line and the temperature sounding line.
STABILITY INDICES				
11. Lifted index	LI	°C	86 LIFTED INDEX	$LI = T_{500 \text{ mb}} - \text{Parcel } T_{500 \text{ mb}}$
12. K index	K	°C	87 K INDEX	$K = (T_{850} - T_{500}) + DP_{850} + (700 \text{ mb DP depression})$
13. Totals-Totals		°C	88 TOT-TOT INDEX	$\text{Totals-Totals} = ((T_{850} - T_{500}) \times 2) - (850 \text{ mb DP depression})$
THERMODYNAMIC ENERGY PARAMETERS				
14. Positive buoyant energy	B	Jkg ⁻¹	89 POS BUOY	Thermodynamic energy parameters are computed as mass averages of appropriate temperature differences using all pertinent interpolated levels. Parameters 14, 15, 16 and 17 are determined by the parcel (parameters 1-3) and by the temperature sounding. Parameters 18 and 19 are determined by a parcel defined by parameters 3 and 20.
15. Negative buoyant energy (LCL to LFC)	$N_{LCL-LFC}$	Jkg ⁻¹	90 NEG E(LCL-LFC)	
16. Negative buoyant energy (surface to LCL)	$N_{SFC-LCL}$	Jkg ⁻¹	91 NEG E(SFC-LCL)	
17. Negative buoyant energy (total below LFC)	N	Jkg ⁻¹	92 TOT NEG E	
18. Additional heat energy required to reach convective temperature	H	Jkg ⁻¹	94 E to CNVCT TEMP	
19. Positive buoyant energy from parcel at the CCL	B_{CCL}	Jkg ⁻¹	95 POS BUOY CCL	

ADDITIONAL THERMODYNAMIC PARAMETERS (continued from previous page)

20. Convective temperature	T_c	$^{\circ}C$	93	CONVECT TEMP
21. Maximum possible updraft velocity	w_{max}	ms^{-1}	96	MAX V V
22. Minimum wet-bulb potential temperature (θ_w)	θ_{wmin}	$^{\circ}C$	97	MIN THETA W
23. Height of minimum θ_w	$HT_{\theta_{wmin}}$	m	98	HT MIN THETA W
24. Wind directions at height of θ_w minimum	$DIR_{\theta_{wmin}}$	deg	99	DIR MIN THETA W
25. Wind speed at height of minimum θ_w	$SPD_{\theta_{wmin}}$	ms^{-1}	100	SPD MIN THETA W
26. Height of $0^{\circ}C$ wet-bulb temperature	$HT_{T_w=0}$	m	101	HT WB ZERO

Convective temperature is defined as a surface temperature with the same potential temperature as the CCL.

The maximum possible updraft velocity is based on the positive buoyant energy, B.

WIND PARAMETERS

27. Mean wind direction in 3-10 km layer	DIR_{3-10km}	deg.	102	MEAN DIR (3-10km)
28. Mean wind speed in 3-10 km layer	SPD_{3-10km}	ms^{-1}	103	MEAN SPD (3-10km)
Average magnitude of wind shear vector:				
29. 0-3 km layer		$ms^{-1}km^{-1}$	104	0-3KM SHEAR
30. 3-10 km layer		$ms^{-1}km^{-1}$	105	3-10KM SHEAR
Average turning of wind:				
31. 0-3 km		deg km^{-1}	106	0-3KM DIR TURN
32. 3-10 km		deg km^{-1}	107	3-10KM DIR TURN

The mean wind is a mass weighted average. Heights refer to above the surface, not MSL.

COMBINED PARAMETER

33. Mean Richardson No. (Ri) from LCL to 10 km			108	RI
--	--	--	-----	----

$$Ri = \frac{\left(\frac{g}{\theta} \frac{\partial \theta}{\partial z} \right)}{\left(\frac{\partial v}{\partial z} \right)^2}$$

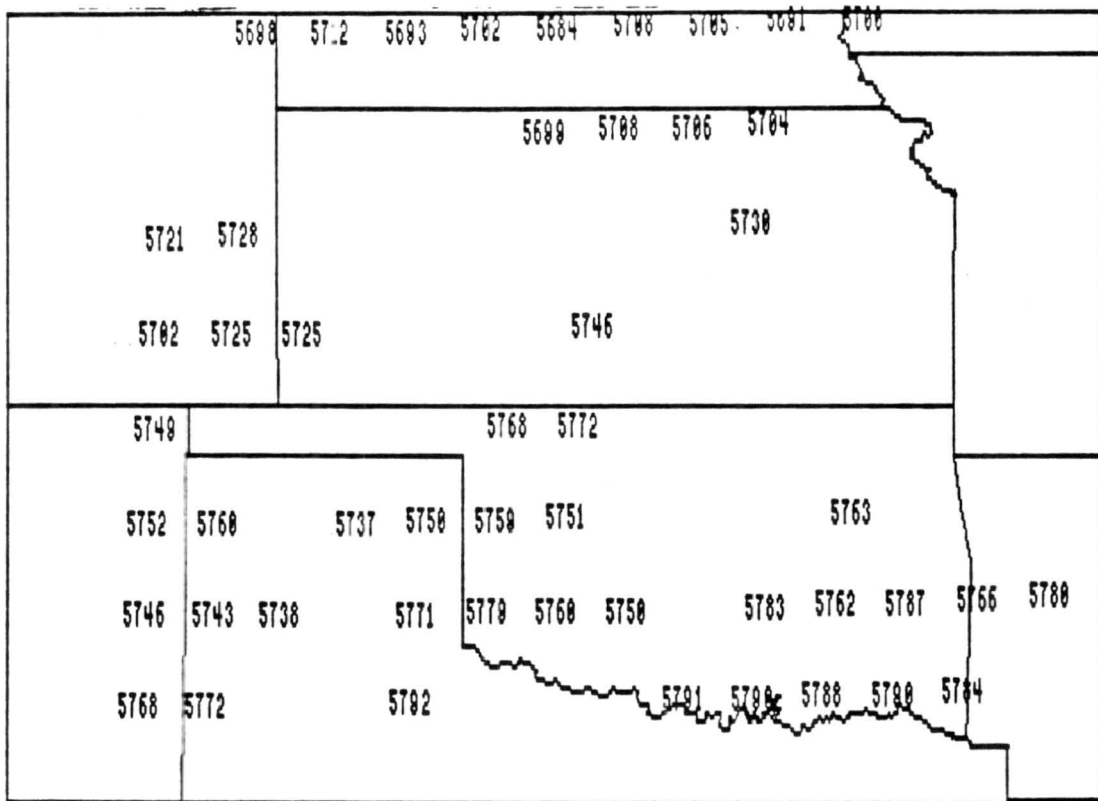

Figure 12. Example of 500 mb geopotential heights plotted from VAS retrievals in PRE-STORM area for 6 May 1985 at 1418 GMT.

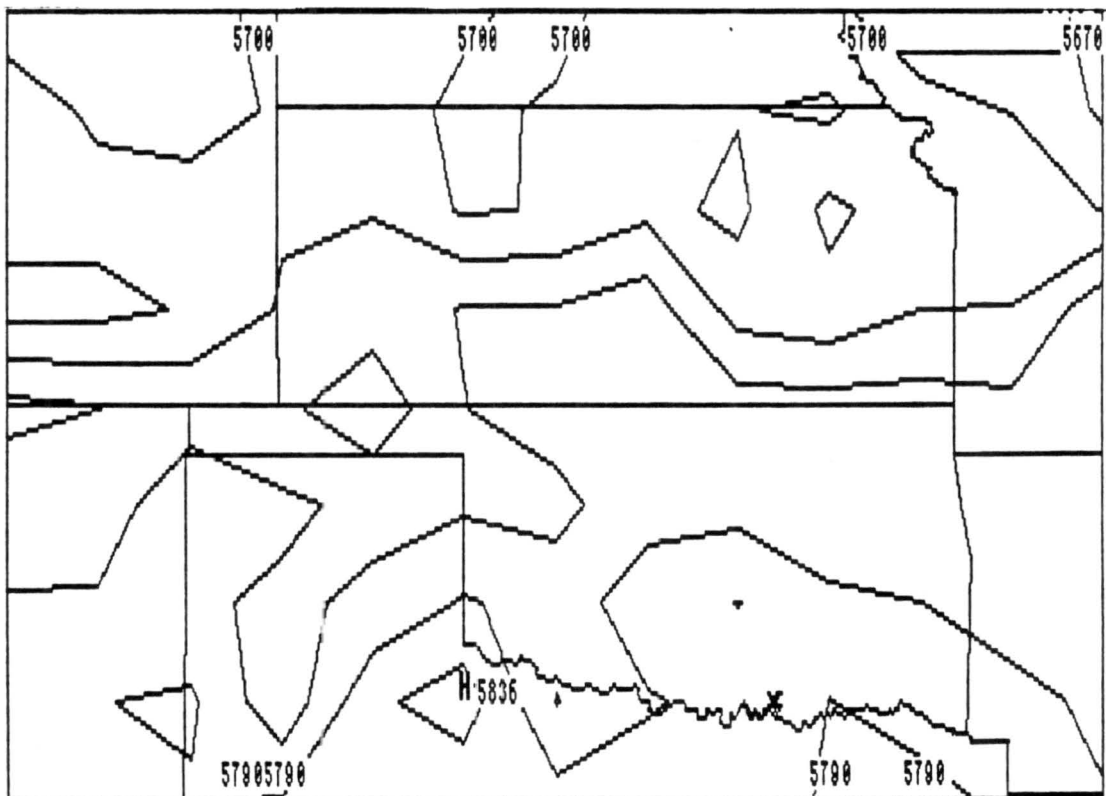

Figure 13. IBM-PC workstation objective analysis of VAS 500 mb geopotential heights for 6 May 1985 at 1418 GMT.

thermodynamic parameters, rather than in conventional analyses of heights and temperatures at constant pressure levels. For example, energy computations based on parcel theory (applied to individual VAS retrievals) may be analyzed to indicate convective potential in different mesoscale regions. One such computation yields positive buoyant energy. The positive area resulting from lifting a parcel of air mixed in the lowest kilometer, is a measure of buoyant energy (B, or convective available potential energy, CAPE). This "positive area" is a more precise measure of the potential instability than those estimated by stability indices such as Totals-Totals and Lifted Index.

```

SNDS NUMBER 25      6MAY85  1718 GMT  LAT,LON = ( 42.85  93.61)

Mean Dew Point and Mixing Ratio in lowest km  -1.8 C   3.9 g/kg
LCL:  Height      Pressure  Temperature  Mixing Ratio
      2534.6 m    749.3 mb   -3.8 C      3.88 g/kg
Pressure at LFC:  999.8 mb   at EL:  99.8 mb   at CCL:  648.8
Indexes:          Lifted      "K"         Total Totals
                  6.7         -18.6       33.8

Buoyant Energy: Positive Negative-(LCL to LFC) -(SFC to LCL) -(Total below LFC)
                  .8         -14838.1    -112.1     -14958.2 J/kg
Convect Temp 26.6 C Energy to Reach CT  624.5 J/kg +Buoy Eng(CCL)  26.5
Maximum Possible Vertical Velocity in Updraft      .8 m/s
Minimum Wet-bulb Potential Temperature            7.8 C
                  at Height      1499.8 m
                  with Wind      299.8 deg at  11.8 m/s
Height of 8C Wet-bulb Temperature                1583.5 m
Mean Wind in 3 - 10 km Layer                      285.9 deg at  10.6 m/s

                  ( 0-3 km)  ( 3-10 km)
Average Magnitude of Shear Vector                15.4      74.1 (m/s)/km
Average Turning of Wind (absolute)               15.4      41.4 (m/s)/km
Mean Richardson Number Cloudbase-10 km (RI>0)   2.7
Pause.
Please press <return> to continue.

```

Figure 14. IBM-PC workstation sounding analysis output showing derived parameters from a VAS retrieval.

Figure 15 shows an example from PRE-STORM where the analysis of "positive area" (Fig. 15a) indicates a maximum region which corresponds approximately to the strongest convective development during the next several hours as indicated by the IR satellite image (Fig. 15b).

However, thunderstorm development does not directly correspond with "positive area". The available buoyant energy cannot be realized unless air parcels are lifted to their LFC (level of free convection). The IBM PC sounding analysis package computes "negative area", both below the LCL (lifted condensation level) and in the layer between the LCL and LFC (Fig. 16). The VAS retrievals can then be used to delineate areas in which deep convection may be initiated by minimal lifting mechanisms as opposed to regions where strong lifting is required to initiate convection. The available buoyant energy may also be realized by heating a low-level parcel. The amount of heat energy necessary for a parcel to attain convective temperature (i.e., no lift required to initiate convection) and the positive area resulting from this parcel is computed by the IBM PC sounding analysis. This positive area (B_{CCL}) has proven to be particularly useful when trying to assess convective available potential energy from a set of morning VAS retrievals. With a low-level inversion present, the available buoyancy (B) in a lowest kilometer mixed parcel is often zero. However, the B_{CCL} quantities give an estimate of the distribution of available buoyancy during the afternoon after the boundary layer has been heated to a dry adiabatic lapse rate. Caution must be exercised in interpreting this product since high values of B_{CCL} often occur in very dry or stable regions with a very high CCL (convective condensation level) and a very warm convective temperature. Figure 16 summarizes the bulk thermodynamic energy parameters

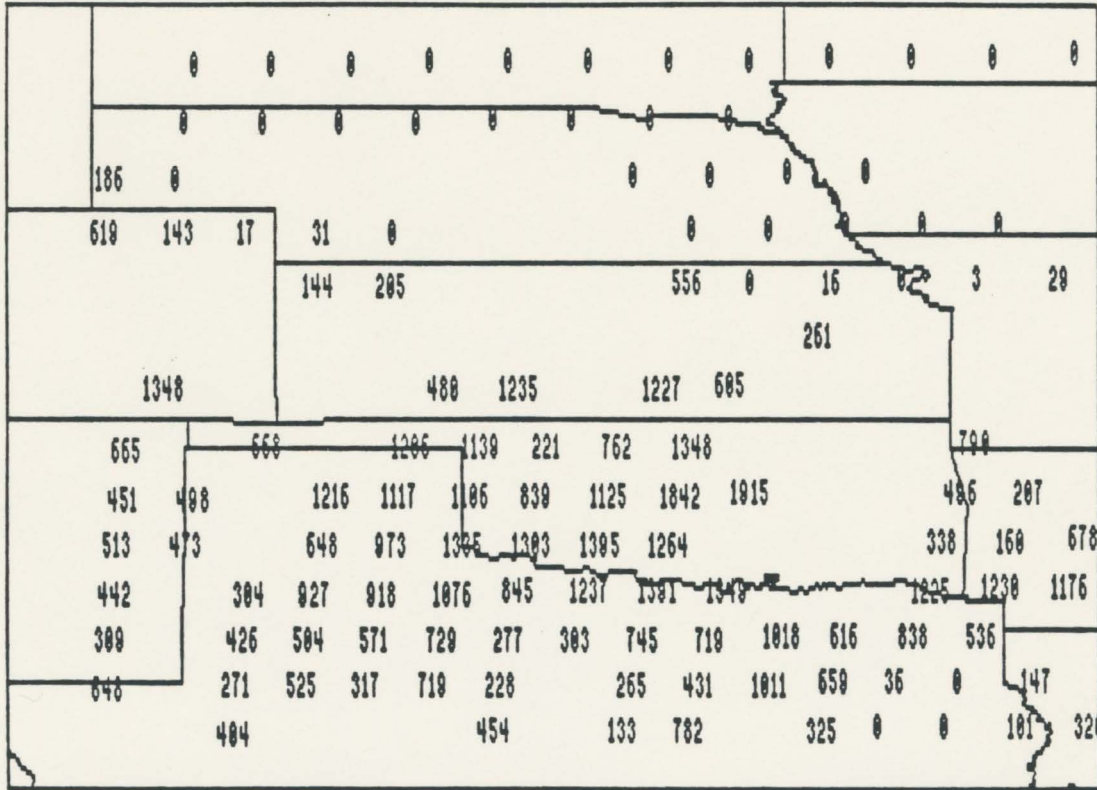

Figure 15a. Example of a "positive area" analysis from PRE-STORM. B(Jkg⁻¹) for 6 May 1985 at 2318 GMT.

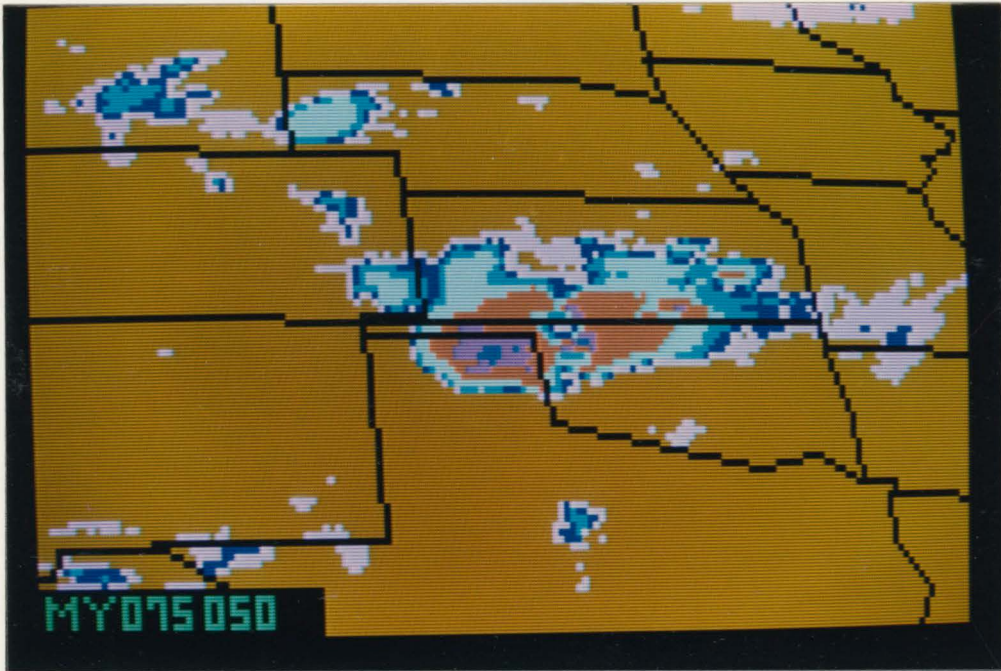

Figure 15b. IR satellite image from IBM-PC workstation for 7 May 1985 at 0500 GMT.

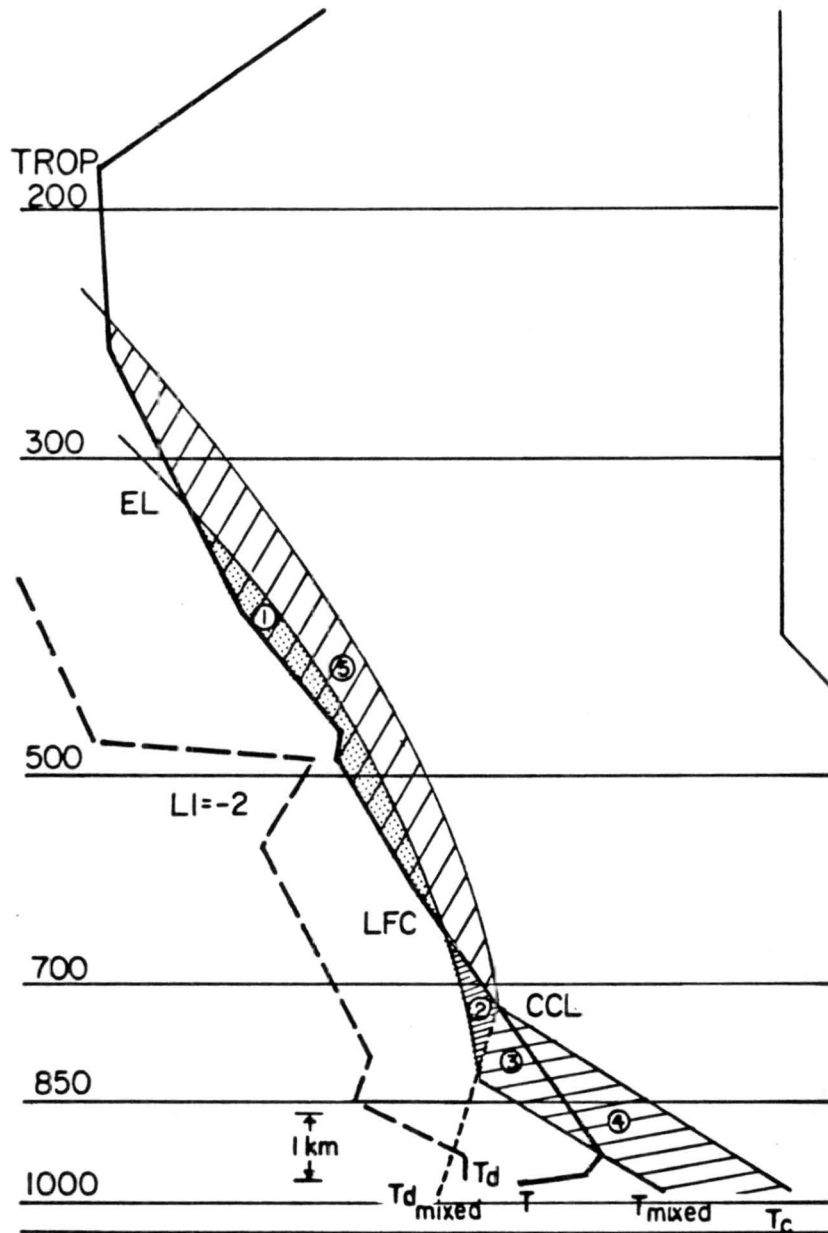

Figure 16. Diagram illustrating bulk thermodynamic parameters computed from VAS retrievals on a skew-T, log-P thermodynamic chart.

1. "positive area", B , available buoyant chart.
2. "negative area", N , between LCL and LFC.
3. "negative area", N , between the surface and the LCL.
4. "heating area", H , heat energy needed to reach convective temperature, T_c .
5. "positive area", B_{CCL} , assuming convective temperature is reached.

computed from VAS retrievals during PRE-STORM which are being evaluated with regard to product development for convective nowcasting and forecasting.

Figure 17 shows an example of VAS products generated in real-time at PRE-STORM, and how they can be used to anticipate thunderstorm development. The B_{CCL} from the VAS retrievals at 1718 GMT are shown in Fig. 17a, which also includes an analysis of convective temperatures computed from the same set of VAS retrievals. The shaded region is where analysis indicates $B_{CCL} \geq 800 \text{ Jkg}^{-1}$ and T_c (convective temperature $\leq 33^\circ\text{C}$). Fig. 17b and 17c show the positive area (B) for 1718 GMT and 2018 GMT respectively. Note that the shaded region in Fig. 17a corresponds approximately to the region with $B > 1000 \text{ Jkg}^{-1}$, three hours later at 2018 GMT, while very low values of B appeared in this region (southeast Oklahoma) at 1718 GMT. The subsequent thunderstorm development is depicted in the radar summary chart and IR satellite image in Figs. 17d and 17e. The nocturnal thunderstorm activity occurred in or near the shaded region of Fig. 17a which was derived from VAS retrievals at 1718 GMT. Additional cases are being reviewed to assess how consistently this type of analysis correctly identifies regions of subsequent thunderstorm development.

All of the bulk thermodynamic quantities, discussed previously, are strongly influenced by the water vapor content of the lifted parcel (lowest kilometer mixing ratio). Many previous studies have shown the importance of boundary layer water vapor to mesoscale convective systems. It is important to note that the integrated water vapor beneath convective cloud base determines the buoyancy available to a cloud. When a shallow moist layer is present beneath a very dry layer within the lowest kilometer, the surface dew point observations are unrepresentative of the sub-convective cloud layer. Radiosonde

SNDG PARAM: POS BUOY CCL 6MAY85 1718 GMT

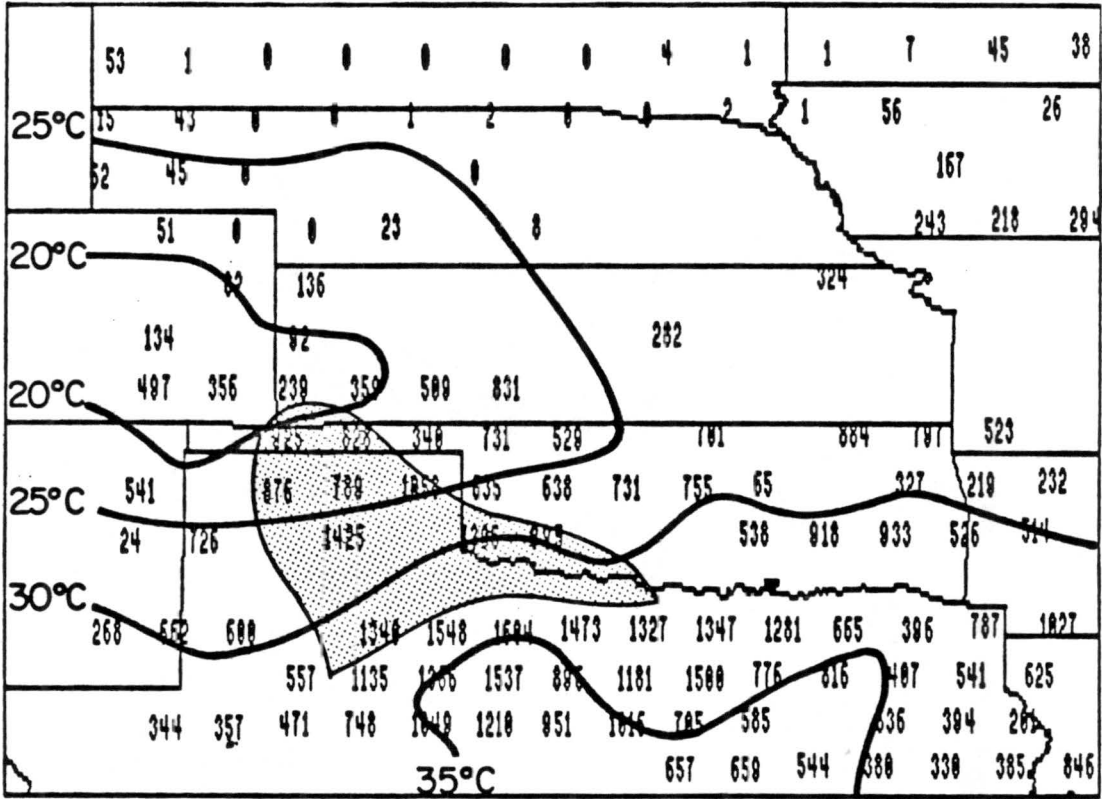

Figure 17a. B_{CCL} , positive area assuming convective temperature, and analysis of convective temperature for 6 May 1985 at 1718 GMT (the shaded region is where $B_{CCL} \geq 800 \text{ Jkg}^{-1}$ and $T_c \leq 33^\circ$).

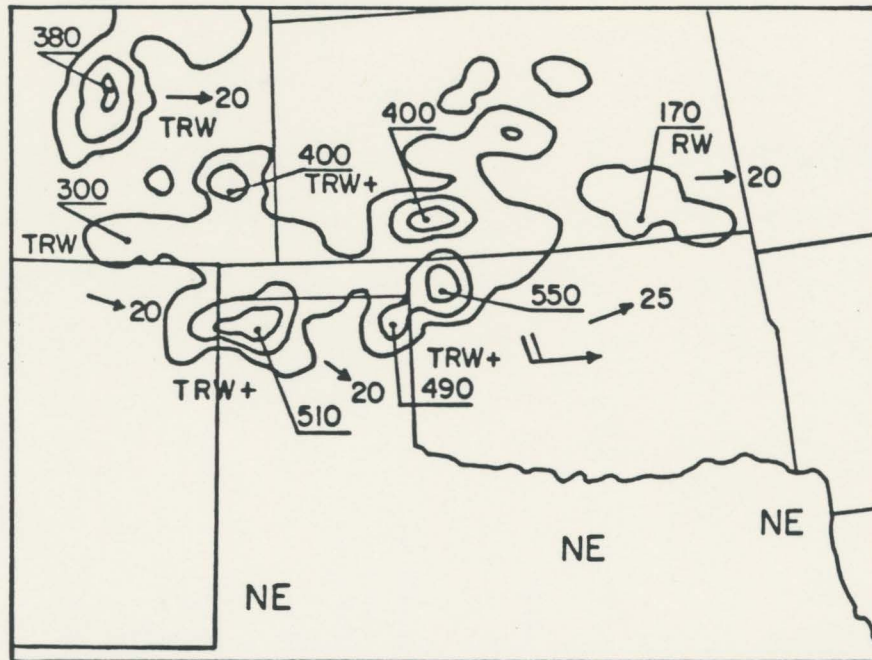

Figure 17d. Radar summary chart, for 7 May 1985 at 0235 GMT.



Figure 17e. IR satellite image from IBM-PC for 7 May 1985 at 0300 GMT.

observations are lacking in horizontal space and time resolution to adequately define such regions. The VAS retrieval data sets show promise of helping to accurately resolve the sub-cloud layer moisture distribution. For example, the lowest kilometer dew point from the VAS retrievals on 20 June, 1985, are depicted in Figure 18a. The corresponding surface dew point analysis in Fig. 18b does not show the relatively dry air mass indicated by VAS in north central Texas. The Stephenville, Texas, radiosonde observation at 1200 GMT (Fig. 18c) shows the top of the moist layer at 950 mb, i.e., only about 200m deep. The horizontal extent and time changes of the sub-cloud water vapor is of primary importance to the evolution of mesoscale convective systems, and may be best measured by the VAS instrument.

Research work at CIRA prior to PRE-STORM has shown that VAS retrieval data is particularly useful in combination with other data for detailed mesoscale air mass analysis. For example, some features such as sharp inversion layers, resolvable in radiosonde data, are not well defined by VAS retrievals due to the lack of vertical resolution. Nevertheless, the VAS retrievals appear to do a good job of resolving the bulk layer distribution of temperature and water vapor as it relates to the convective potential of particular air masses. More importantly, VAS allows these air masses to be monitored on mesoscale horizontal and time scales which are not resolved by the conventional radiosonde network. Furthermore, conventional satellite imagery often allows precise boundaries which are only approximated by the resolution of the VAS retrievals. The retrievals in turn define the air mass characteristics within particular boundaries.

In summary, the PRE-STORM experiment offered a unique opportunity to collect VAS data sets with high quality supporting data for research and

SNDG PARAM: 0-1KM DEW PT C 20JUN85 1718 GMT

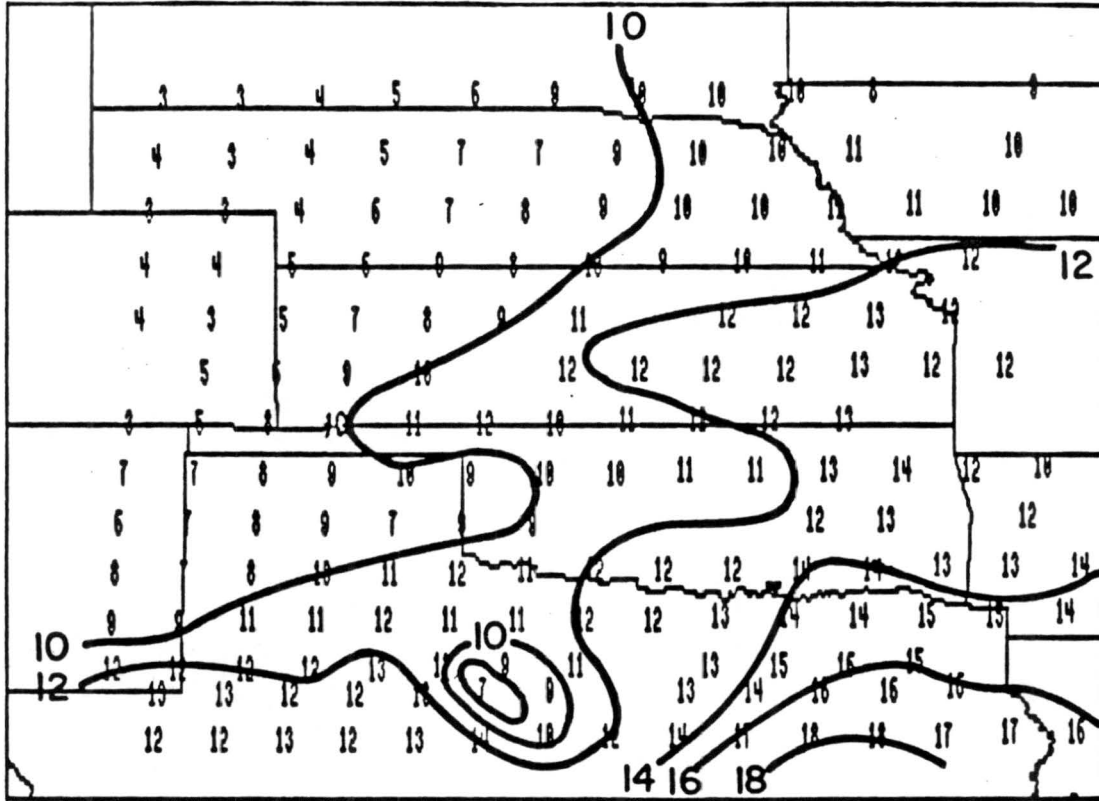

Figure 18a. Analysis of lowest kilometer dew point ($^{\circ}\text{C}$) from the VAS retrievals for 20 June 1985 at 1718 GMT.

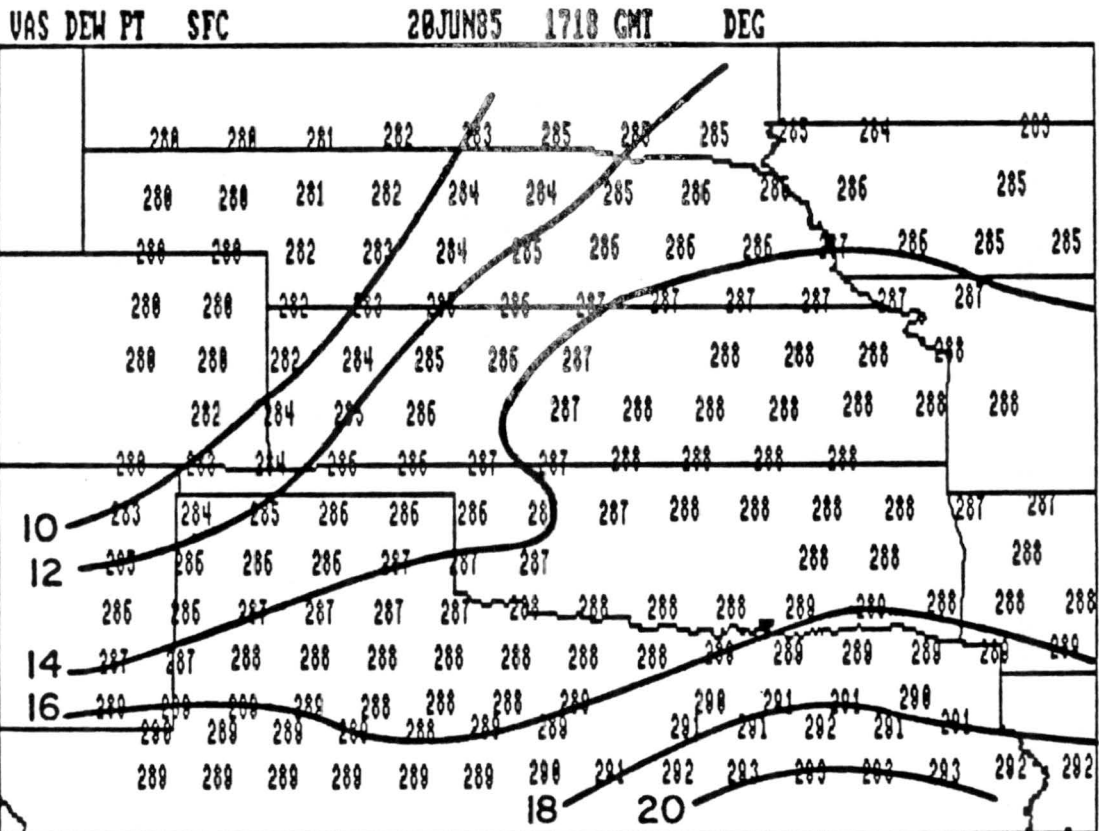

Figure 18b. Analysis of surface dew point, ($^{\circ}\text{C}$, plotted values are $^{\circ}\text{K}$) for 20 June 1985 at 1718 GMT.

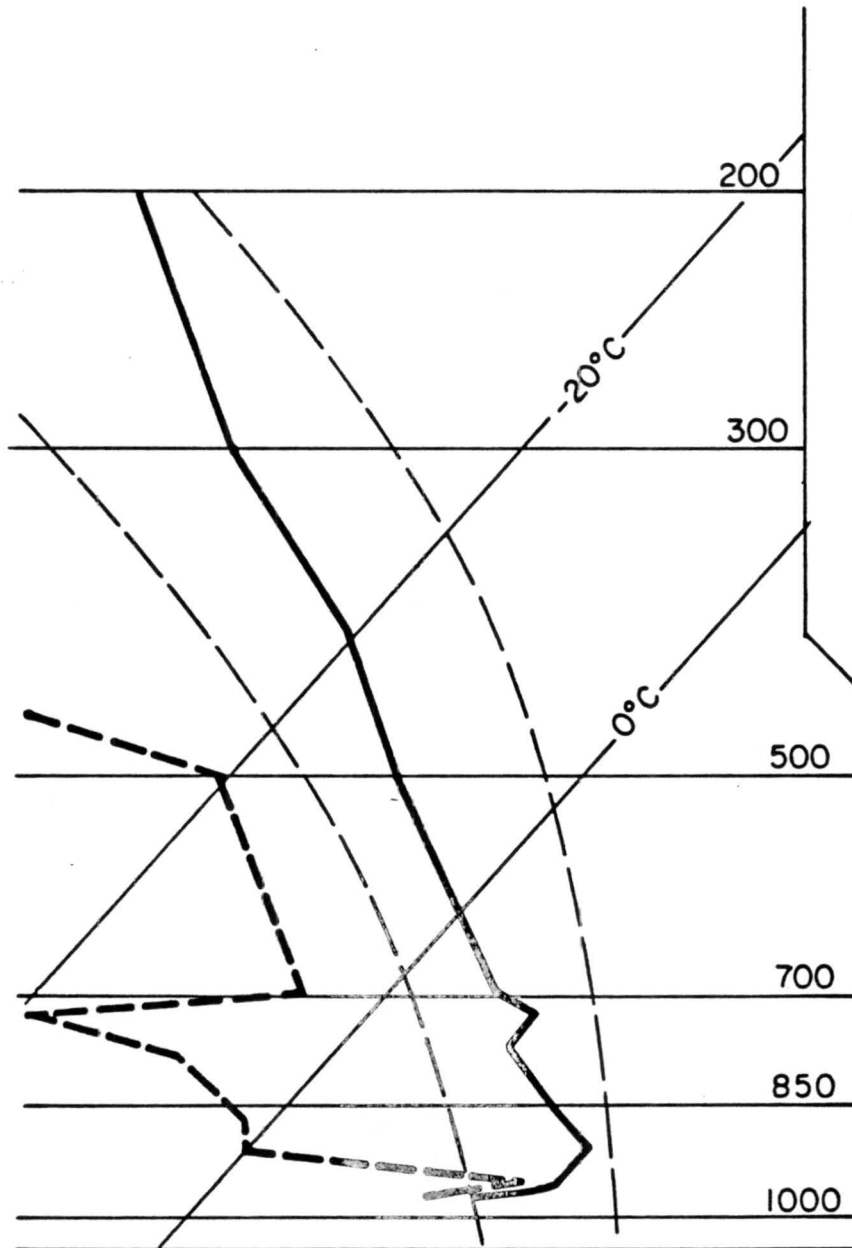

Figure 18c. Stephenville, TX, (SEP), radiosonde observation for 20 June 1985 at 1200 GMT.

development, and to test utility of VAS to support real-time decision making. It is very unfortunate that one of the two GOES satellites with the VAS instrument aboard became inoperable in August, 1984. With only one operational GOES, and with rapid interval (5-min) images (RISOP) becoming operational during 1985, the availability of VAS retrieval data during PRE-STORM was severely limited. Also, retrieval processing was not performed in real-time at the ASPP, University of Wisconsin, during weekends. Therefore, a large proportion of the VAS retrievals collected during PRE-STORM were usually during the 1100 - 1700 GMT period, or on inactive convective days. Since PRE-STORM emphasis was on nocturnal systems and most of the VAS retrievals were received from morning data, operational support provided by VAS retrievals at PRE-STORM was limited due to lack of current data. Nevertheless, as illustrated in this report, several interesting data sets were obtained, and research and development is continuing at CIRA with these data. The NOAA-9 polar orbiting satellite was operating during PRE-STORM with a sounding instrument on board (CO₂ channels plus microwave). Retrievals derived from NOAA-9 orbital passes at approximately 0900-1000 GMT and 2000-2100 GMT can be derived to supplement the PRE-STORM data sets. The VAS data availability problem is expected to be alleviated soon with a successful launch of the next GOES in April, 1986.

5. Real-time Support to PRE-STORM: 26 April - 27 June 1985, John Weaver

Real-time support to the PRE-STORM experiment was provided in the form of 1) real-time VISSR/VAS satellite data at the PRE-STORM Operations Center, 2) an on-site Personal Computer (PC) workstation to analyze and display these data, and 3) support scientists to operate the workstation and to assist in interpreting the results. The support scientists were available throughout the morning to assist the forecast team, as well as during the afternoon and evening hours of operational days to provide nowcast information to the forecasters and to the Operations Director. From the PRE-STORM perspective, the satellite support group mission was to supply supplementary satellite data for both general and short range forecasts. From the CIRA viewpoint, the mission also included; 1) evaluating the feasibility of using a PC as an operational workstation, and 2) assessing the usefulness of VAS retrieval information in forecasting mesoscale convection. This section summarizes those operations.

CIRA supplied all of the equipment for its part of the experiment, including a PC workstation (see section 2) and NESDIS/RAMM Branch provided a vehicle for transportation. Since time was required for transportation and set-up, the group's participation actually began several days prior to the start of operations. Bob Green (NESDIS/CIRA) handled this phase of the project -- leaving CIRA on the morning of April 26th and arriving in Oklahoma City at 1300 local time (LT) on the 27th. The entire system was set-up, de-bugged and operating to near full capacity by May 5th which was the first day of data collection. The total job was completed in ~85 hours over a 9 day period (see Fig. 19). The remaining four days of Bob's PRE-STORM time were spent refining data collection software and in furnishing decision support on two operational case days. During this period, a daily archival procedure was begun which

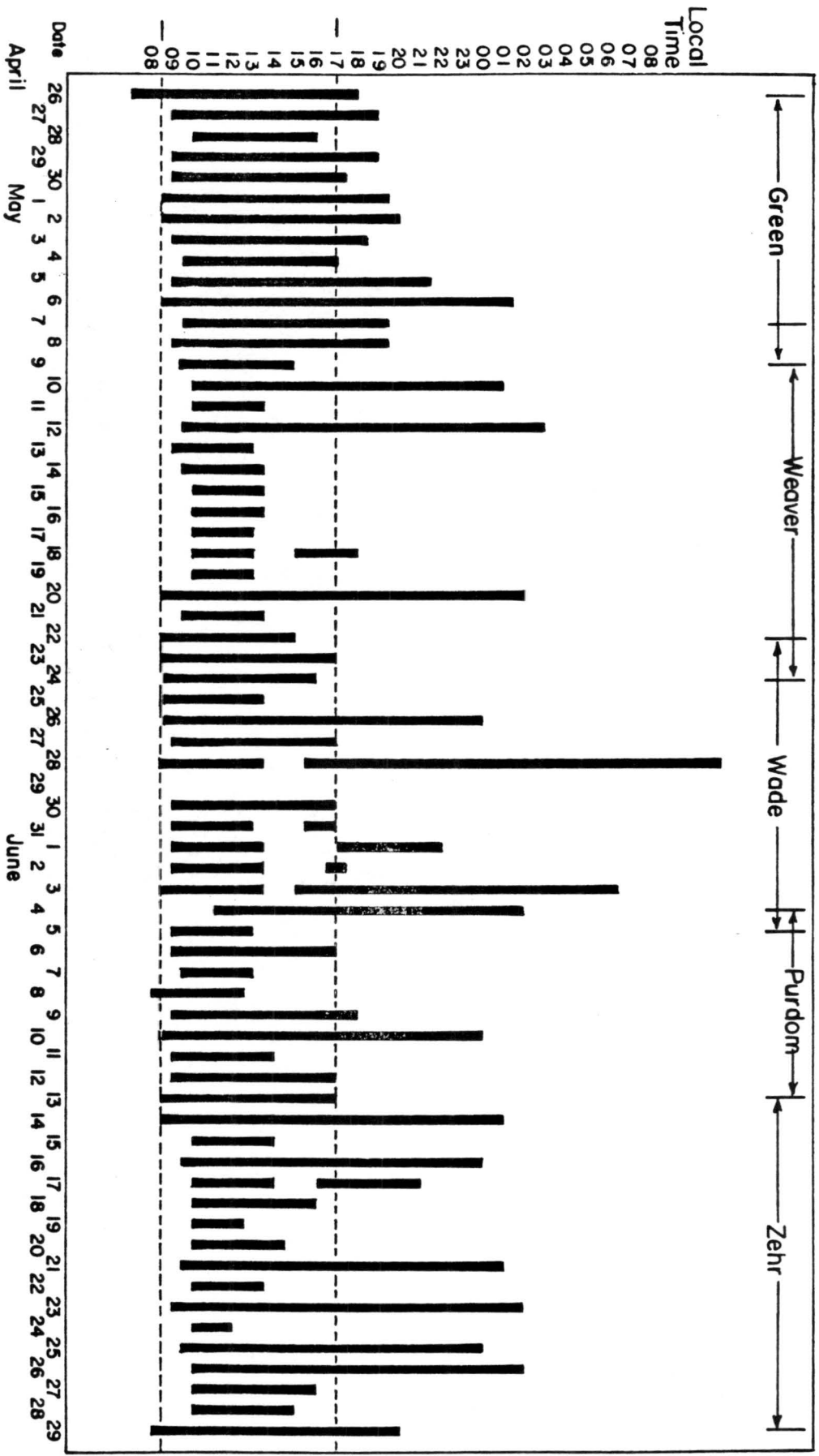

Figure 19. Hours that the NESDIS, PC workstation was manned (work hours) during PRE-STORM. Time shown is Central Standard Time (CST), and reads from the origin upward.

continued throughout the PRE-STORM program. Each morning all processed VAS retrieval data and/or VISSR imagery collected at OKC were saved to diskette. The resulting data set represents a relatively complete satellite record of the season. Various cases are currently being studied at CIRA.

John Weaver (NESDIS/CIRA) arrived in OKC on 7 May to take over from Bob Green. The 7th and 8th were "down-days" at PRE-STORM. Those two days were spent documenting the latest PC system changes, and in processing data for a case study (6 May 85) to be presented at the 14th Conference on Severe Local Storms (Green and Weaver, 1985). 9 May was also a down-day, but marked the introduction of a short "VAS segment" to the morning weather briefing. Products which had been derived from the VAS retrievals (see Section 4) were presented and discussed. The presentations furnished supplementary nowcast information to the forecasters in several cases. The discussions also helped the satellite support scientists learn more about use of the VAS data source in real-time.

During the remainder of Weaver's stay (Fig. 19), there were only three flight days (Fig. 20). These occurred on May 10-11, May 12-13 and May 20-21. Of the three, the most interesting by far was May 12-13. The case began with a tornadic squall line forming rapidly in central TX and building northward into central OK (several large funnel clouds were observed from just outside the PRE-STORM OPS center). The system gradually expanded throughout the evening into a large mesoscale complex which ended up providing a good data set over the mesonet. Special soundings were also released.

Gary Wade (NESDIS/CIMSS) arrived on May 21st, and the next three days were spent bringing him up to speed on the system. Also during this period Gary performed selected upgrades to the system, such as new color enhancements for the water vapor imagery.

Over the next few weeks, there were numerous examples of mesoscale convective systems (Fig. 20). Also of note -- during this period the longest continuous case day occurred. The workstation was powered-up at 0820 CST on 28 May to begin the routine morning forecast, and, with only a few short breaks for meals, was manned continuously until 1230 CST on 29 May. Since there was only one satellite support scientist at PRE-STORM on any given day (except for the one or two day transition periods), this meant a 28 hour shift for Gary. Fortunately, the weather co-operated to provide an excellent MCS case for the effort.

Jim Purdom (NESDIS/CIRA) worked at PRE-STORM from Jun 4 - Jun 13. During his stay, there were two operational days with flight missions -- one was flown during a very weak, stratiform rain event (4-5 Jun), the other in and around a large squall line in central OK (10-11 Jun). Both days were RISOP days, and no VAS retrievals were available. Additionally, on the 9th of June, data were collected for a case in which systems developed, but failed to grow to significant proportions. Understanding such cases is important if forecasters are to avoid false alarms in outlooking MCS activity.

Ray Zehr (NESDIS/CIRA) and Debra Lubich (CIRA) arrived in OKC on the morning of June 13th. Ray was there to work the final two weeks of the PRE-STORM season, while Debra returned to Colorado the next day, after affecting repairs on the workstation.

There were five flight days between June 13th and the 27th. The missions included the following weather events; 1) two large convective regions which joined one another via a squall line along a front (14-15 Jun), 2) the early stages of an MCC in Kansas (16-17 Jun), 3) highly variable convective activity

growing to an MCS (21-22 Jun), 4) a dissipating MCC (23-24 Jun), and 5) frontal and post-frontal convection (26-27 Jun). The last case marked the official end to the program, and Ray spent his final two days transporting the equipment back to Fort Collins.

In general, the satellite support portion of the PRE-STORM experiment was quite successful, and the man hours allotted to the project considered well spent. Beginning on 9 May, information derived from VAS retrievals became part of the morning weather briefing. Not only did the data help clarify the mesoscale situation on a few occasions, but many times audience feedback provided ideas for refining the forecast products.

Satellite data were used quite often in a decision support capacity. In one instance (12 May), VIS imagery furnished lead-time on an unexpected moisture return into central TX and central OK. (Earlier forecast data had suggested that the return would occur much further west.) Also, infrared loops proved quite useful on several occasions. Most PRE-STORM participants involved in decision making used these loops often. On several occasions the IR data were used to decide where to vector aircraft in order to conduct the most effective data collection, and/or which areas were becoming organized on larger scales.

There were direct benefits to VAS from the experiment. During the program, many scientists and forecasters were briefed on the VAS data and many NWS personnel got their first glimpse of the use of VAS in real-time. Such briefings help promote the use of the new data source, and the exchanges also furnish ideas for product development.

The PRE-STORM experiment made it clear that VAS retrievals and digital imagery can be efficiently delivered to, and processed by, a PC workstation. Though many improvements are needed, the general concept of an inexpensive PC

workstation, working through a distant main-frame computer, has been proven.

The requisite improvements identified at Oklahoma City include:

- 1) reconfiguring of product scheduling and priorities on the main-frame computer;
- 2) higher resolution imagery;
- 3) improved product formats; and,
- 4) better forecast products (for which further research is required).

The experiment did, effectively, show the utility of VAS sounding data in a mesoscale forecast environment.

6. Data Archived at CIRA, Debra Lubich

The PRE-STORM data archived at the Cooperative Institute for Research in the Atmosphere (CIRA) is summarized in Tables 6a and b. The satellite mode indicates type of data available from the GOES satellite (RISOP or VAS soundings and imagery). Table 7 gives a detailed listing of RISOP start times.

Data processed on the PC workstation consists of imagery and VAS retrievals. Visible and infrared imagery were downloaded on a nominal hourly or half hourly basis. Water vapor imagery was normally taken once every 2 hours. VAS retrievals were scheduled for 11Z, 13Z, 14Z, 17Z and 20Z, daily, and were downloaded when available. All PC workstation data were stored on 5 1/4" floppy diskettes, using the MS-DOS BACK UP command. A detailed listing of PC data available by date and time is given in Tables 8a-c and 9a-c.

GOES satellite data was collected by the CSU Groundstation on selected RISOP days. That visible and infrared imagery is stored on 1600 bpi magnetic tapes, and requires special preprocessing on the CSU VAX 11/780. Multispectral image (MSI) collection became fully operational at CSU in June. This data is also stored on 1600 bpi magnetic tape and also requires preprocessing.

Table 6 also lists the TIROS (NOAA-9) image data which has been archived at CIRA. This data is also stored on 1600 bpi magnetic tape. Sounding data from NOAA-9 are also available from the NESDIS archive at Camp Springs, Maryland. The data are available as full resolution calibrated sounder channel radiance data.

Additional GOES data (VISSR and VAS) for the full PRE-STORM period is available from the NESDIS archive at the University of Wisconsin. VAS data is available for most of the specified times (11Z, 13Z, 14Z, 17Z, 20Z) when RISOP did not pre-empt its collection, see Table 10.

Table 6a

CIRA
PRE-STORM Data Archive May 1985

Date May	PRE-STORM "Go" Days	Satellite Mode R=RISOP V=VAS	IBM-PC VAS Retrievals 11Z 13Z 14Z 17Z 20Z	IBM-PC Images	TIROS-N AVHRR	GSU Data Collection RISOP MSI 30-Min
1		R and V	X X	X X		
2		R and V	X X	X X		
3		V	X	X		
4		V				
5	X	V		X		
6	X	V		X		
7	X	R and V		X		
8		V				
9		V	X	X		X
10	X	R and V		X		X
11	X	R and V	X	X		X
12	X	R and V		X	X	X
13	X	R		X		X
14		R				
15		V	X			X
16		R and V	X	X		
17		V				
18		V				
19		V				
20	X	R and V	X X	X X		
21	X	V	X X	X X		
22		V	X X	X X		
23		V	X X	X X		
24		R and V	X X	X X		
25		V	X X	X X		
26	X	R and V	X X	X X		
27	X	R	X	X		X
28		R and V	X X	X X		
29		R and V	X	X		X
30	X	R and R	X	X		X
31		R				

Table 6b

Date June	PRE-STORM "Co" Days	Satellite Mode		IBM-PC VAS Retrievals					IBM-PC Images	TIROS-N AVHRR	CSU Data Collection	
		R=RISOP	V=VAS	11Z	13Z	14Z	17Z	20Z			RISOP	MSI 30-Min
1												
2	X	R	and	X		X			X		X	X
3	X	R	and	X		X			X		X	X
4	X	R							X			
5	X	R	R						X		X	
6		R	and			X			X			
7		R	and						X			
8		R	and									
9		R							X			
10	X	R	R						X		X	X
11	X	R	and	X		X			X		X	X
12		R	V	X		X			X		X	
13		R	V	X		X			X		X	
14	X	R	and	X		X			X		X	X
15	X	R	and						X		X	X
16	X	R	and						X		X	X
17	X	R	and		X				X		X	X
18			V			X			X		X	
19			V			X			X		X	
20			V			X			X		X	
21	X	R	and	X		X			X		X	X
22	X	R				X			X		X	X
23	X	R	R			X			X		X	X
24	X	R	R			X			X		X	X
25		R	R						X		X	X
26	X	R	and						X		X	X
27	X	R	and						X		X	X
28		R	V						X		X	
29		R	V						X		X	
30		R	and						X		X	

Table 7

RISOP Start Times -- 1985, PRE-STORM Season

<u>Date</u>	<u>RISOP Start Time (GMT)*</u>	<u>Date</u>	<u>RISOP Start Time (GMT)*</u>
4/27	2130	6/2	1600
4/28	1700	6/3	extended
4/29	1000	6/4	extended
4/30	1930	6/5	extended
5/1	1700	6/6	1830
5/2	1730	6/7	1830
5/7	2000	6/8	1700
5/10	1630	6/9	1530
5/11	1530	6/10	extended
5/12	2230	6/11	extended-SP
5/13	extended	6/14	2000
5/14	1600	6/15	1730
5/16	2030	6/16	1700
5/20	1830	6/17	extended-SP
5/24	2300	6/21	1830
5/26	1830	6/23	1530
5/27	extended	6/24	1200-1400
5/28	1730	6/24	1830
5/29	1630	6/25	extended
5/30	extended	6/26	1930
5/31	extended	6/27	1530
6/1	extended		

*Normal stop time - 0730 GMT

extended = ran all night into following day

extended-SP = few hour break into morning

Table 8a. May (0000Z - 0730Z)

PRE-STORM IBM PC DATA ARCHIVAL -- MAY 1985

v=visible image

i=IR image

w=water vapor image

r=VAS retrieval

(GMT) hr Day 1	0 :30	1 :30	2 :30	3 :30	4 :30	5 :30	6 :30	7 :30
2		i		i i				
3	vi	i i	i i	i i				
4								
5								
6				w				
7	vi	i i	i i	i i	i i	i i	i	i
8			w	w				
9								
10								
11	vi	i i	i i	i	i i	i i	i	
12								
13		i i	i i	i i	i i	i i	w	i
14								
15								
16								
17								
18								
19								
20								
21				i i	i i	i i	i	i
22								
23								
24								
25								
26								
27	vi	i i	i i	i i	i i	i i		
28	vi	i	i	i	i			
29	vi	i i	i i	i i	i i	i i	i	i i
30								
31								

Table 8b. May (0800Z - 1530Z)

PRE-STORM IBM PC DATA ARCHIVAL -- MAY 1985

v=visible image
w=water vapor image
i=IR image
r=VAS retrieval

(GMT) hr Day 1	8 :30	9 :30	10 :30	11 :30	12 :30	13 :30	14 :30	15 :30
1				r		w	r	
2				r			i	i
3	r						r	i
4								
5								i v
6							i v v	
7	i	i	i	i	i	i	r	
8								
9				r w		w	i	v
10				w		w	r	vi
11				r w		w	r	i v
12				w		w	r	i v
13								vi
14								
15				r			i	
16				w		r w	i	vi
17				r			i	vi
18								w
19								
20				r w		w	i	vi
21				r w		w	r	w
22				r w		w	i	vi
23				r w		w	r	w
24				r w		w	i	vi
25				r w		w	r	w
26				r		w	i	vi
27							r	w
28								vi
29	i	i	i	i	i	i	i	vi
30				r			r	vi
31								

Table 8c. May (1600Z - 2330Z)

PRE-STORM IBM PC DATA ARCHIVAL -- MAY 1985

v=visible image

i=IR image

w=water vapor image

r=VAS retrieval

(GMT) hr Day 1	16 :30	17 :30	18 :30	19 :30	20 :30	21 :30	22 :30	23 :30
			i v	i v	v	vi v	vi	
2		vi w		vi v	v	vi v	vi v	vi v
3	vi	vi v r	i v	i	i		vi	
4								
5	vi v	vi v w	i	i v	vi v	vi		
6	vi	i v r w	v	vi v	r	vi v w	vi vi	vi v r w
7								
8			v					
9	vi	vi		vi	v	vi		
10	vi	vi w	vi v	vi v	vi v	vi v	vi	v w
11	i v	vi	vi					
12	i v	i r w	vi v	vi i w	v	vi v w	vi vi	vi v w
13	vi	vi w			i v	vi		v
14								
15	i							
16	vi	vi r w	v	i	i v			
17	vi	v						
18								
19								
20	vi	vi r	vi	i v	vi v	vi v	vi vi	vi
21	i v	i						
22	vi r	i r w	v v	vi v wr	vi	i	vi	i
23	vi	vi r w	vi		i v	vi	vi	vi
24	i v	i r w	vi v	vi v w	v	i		
25		vi w	vi					
26	vi r	i r w	vi v w	vi v	vi v	vi v	vi vi	vi v
27		vi	vi	vi	vi	vi	vi	vi
28	vi	vi r				i v	vi v	vi v
29	i i		i	i				
30								
31								

Table 9a. June (0000Z - 0730Z)

PRE-STORM IBM PC DATA ARCHIVAL -- JUNE 1985

v=visible image
w=water vapor image

i=IR image
r=VAS retrieval

(GMT) hr Day 1	0 :30	1 :30	2 :30	3 :30	4 :30	5 :30	6 :30	7 :30
2	vi i	i i	i i	i				
3	vi i	i i	i i	i i	i i	i	i	
4	vi i	i i	i i	i i	i i	i	i i	i i
5		vi i	i i	i i	i i	i	i i	i i
6								
7								
8								
9		v						
10	vi vi	i i	i i	i i	i i	i		
11	i i	i i	i i	i i	i i	i	i i	i i
12	vi	i	i	i i		i	i	
13								
14								
15	vi i	i i	i i	i i	i i	i	i i	i i
16								
17	vi i	i i	i i	i i	i i	i	i	
18	vi i	i i						
19								
20								
21			i	i				
22	vi i	i i	i i	i i	i i	i	i i	i i
23					i			
24	vi i	i i	i i	i i	i i	i	i i	i i
25								
26	i i	i i	i	i i	i	i		
27	vi i	i i	i i	i i	i i	i	i i	i i
28								
29								
30								
31								

Table 9b. June (0800Z - 1530Z)

PRE-STORM IBM PC DATA ARCHIVAL -- JUNE 1985

v=visible image

i=IR image

w=water vapor image

r=VAS retrieval

(GMT) hr Day 1	8 :30	9 :30	10 :30	11 :30	12 :30	13 :30	14 :30	15 :30
1				r w		r w	i r	i v w
2				r w			r	i v
3							i	vi
4	i i	i	i	i w	i	i		
5								
6						w	r	vi w
7							i	i
8								
9								
10							i	vi
11		i i i		r				
12				r w		w	i r	vi v w
13				r w		w	i r	i v w
14				r w		i w	i v r w	
15	i i	i i i	i	i w	i	i		
16								
17						r w	r	i v w
18				r w		w	r	vi w
19				r w		w	r	vi w
20				r		w	r	w
21				r w			r	vi w
22	i i	i i i	i			i	i	vi v
23								vi
24	i i			i w	i			
25							i	i v
26								i v w
27								
28								
29								
30								
31								

Table 9c. June (1600Z - 2330Z)

PRE-STORM IBM PC DATA ARCHIVAL -- JUNE 1985

v=visible image
w=water vapor image

i=IR image
r=VAS retrieval

(GMT) hr Day 1	16 :30 i v	17 :30 vi	18 :30 i v	19 :30 vi v	20 :30 vi v	21 :30 vi vi	22 :30 vi vi	23 :30 vi v
2	i i	i	vi v	i v	vi v	v v	vi vi	vi v w
3	vi	vi w	i v v			i v	vi vi	vi v w
4		vi w	i	vi v	vi v	vi v	vi vi	vi v w
5								
6	vi v	r		v	i v	vi v	vi vi	vi
7	vi	vi w						
8								w
9		vi w	i v	vi vi	i	vi	vi vi	vi vi i w
10	vi	vi w	i v	vi	vi v	vi v	vi vi	vi v w
11		i v r w	w		i v	vi	vi	vi
12	vi	vi r w	i w		v	vi v	vi vi	
13		vi r w	vi v v			i v w	vi v	
14	vi	vi	vi v	vi v	v	vi v	vi vi	vi v w
15								
16						vi	vi	vi v w
17	i v	vi w	vi v	v	vi	vi v	vi vi	vi v w
18	vi	vi r	vi v w	i v	vi v	vi v		
19	i v	vi w	v					
20	vi v	vi r w	i		r			vi
21	i	i r w	i w	vi v	i	vi v	vi vi	vi v
22	i							
23	vi	vi	vi	i	i	i	i	i v
24								
25	i v	vi	vi v	vi v	i	i	i i	i
26	vi	vi w	i v	vi v w	vi v	vi v	vi vi	vi v
27								
28								
29								
30								
31								

Table 10

VAS Retrieval Data Archived at University of Wisconsin --
1985, PRE-STORM Season

<u>Date</u>	<u>Time (GMT)</u>	<u>Date</u>	<u>Time (GMT)</u>
4/27	10:00-21:30	5/24	10:00-22:48
4/28	10:00-16:30	5/25	all day
4/30	10:00-16:00, 18:00-23:00	5/26	10:00-18:31
5/1	10:00-16:48	5/28	10:00-18:31
5/2	10:00-17:30	5/29	10:00-16:18
5/3	14:00-23:00	6/1	10:00-15:48
5/4	all day	6/2	10:00-15:48
5/5	all day	6/6	10:00-18:31
5/6	all day	6/7	10:00-18:31
5/7	10:00-19:48	6/8	10:00-16:48
5/8	all day	6/11	10:00-18:48
5/9	all day	6/12-6/13	all day
5/10	10:00-16:18	6/14	10:00-20:18
5/11	10:00-15:31	6/15	10:00-17:18
5/12	10:00-19:31	6/16	10:00-17:18
5/14	10:00-14:18	6/17	10:00-16:48
5/15	all day	6/20	all day
5/16	10:00-20:18	6/21	10:00-18:31
5/17-5/19	all day	6/26	10:00-19:18
5/20	10:00-18:31	6/29	all day
5/21-5/23	all day	6/30	10:00-17:18

7. Conclusions and Recommendations

The PRE-STORM experiment offered a unique opportunity to field test a new "workstation" configuration on a personal computer. The PC hardware functioned with exceptional reliability during PRE-STORM. Many features of very expensive image and graphic display systems have been successfully incorporated into an inexpensive workstation. During the PRE-STORM experiment, digital images were delivered and displayed on a PC workstation several minutes faster than through the conventional GOES-tap process. The image products proved to be reliable, timely, and of sufficient resolution to be very helpful in real-time decision making to support PRE-STORM operations.

The various image analysis products, such as histograms of the IR digital counts, and the animation capabilities of the PC were thoroughly evaluated in real-time. A number of improvements and modifications resulted directly from the real-time workstation test. VAS retrieval data sets were collected and archived, along with the image data on the PC, after each operational day. These data sets are being analyzed for at least five case studies from the PRE-STORM experiment. With the high quality supporting data available, PRE-STORM will undoubtedly provide a unique data set for satellite sounding product development. These products will be directly applicable to analysis and forecasting of mesoscale convective systems.

While the objectives of CIRA were fully met during the field phase of the PRE-STORM program, certain needs were able to be identified which would enhance future field program efforts.

- 1) During PRE-STORM the forecast center and the operations center were separated. This made it impossible, in many instances, to get complete sets of information from the operations center into the forecast. Those functions should be combined in a single location.

- 2) Separate display and analysis systems were used in the operations center for satellite, radar, mesonet data, aircraft track data, lightning strike data, etc. While each of these functioned nicely in an independent manner, their screens and information were widely spaced throughout the forecast area. It would have been much preferable to have a PROFS-type workstation on which all data in high-resolution could be displayed as well as animated. Such a workstation should have overlay capabilities for satellite, radar, mesonet, lightning strike data and the like as well as being able to display aircraft flight tracks on top of the image data.
- 3) There is a need to be able to transmit image information from the operations center to the aircraft. That information would be in the form of derived products such as satellite and radar data from the interactive display system. Perhaps, this could be accomplished through the personal computer workstation that is under development at CIRA.
- 4) During PRE-STORM there was a need for more flexibility in accessing various satellite products. That is, when RISOP was in effect, there was a spacecraft conflict and VAS products were unavailable. TIROS data and products were not accessible in the PRE-STORM operations center. By the summer of 1986 there should be two GOES VAS satellites in operation, thus alleviating the RISOP/VAS conflict. Furthermore, in late 1986, a VAS Data Utilization Center will become operational in Washington, DC in the World Weather Building. This will allow for routine 24-hour a day, 7-day a week flow of VAS products to a field site.
- 5) The PRE-STORM field program was run on a very tight budget. One only needs to inspect Figure 19 to realize that people worked many extended, very long and continuous shifts. For a program such as STORM or other field programs that will go on for extended periods of time, there should be sufficient funding to allow adequate staffing.

In looking to the STORM-Central time frame, with a Spring 1990 field experiment, the new generation GOES-I spacecraft should be in operation. GOES-I is to be a 3-axis stabilized spacecraft with a 5-channel imaging system capable of taking 5-minute interval imagery over the United States or imaging an area the size of Oklahoma and Kansas about once every 40 seconds. Sounding operations will be separate from imaging functions on the spacecraft, with a 20-channel radiometer used to do the soundings. These soundings should have a greatly improved signal-to-noise ratio over those from GOES-VAS since 3-axis stabilization will allow the sounder to dwell on a single sounding field of

view. In that same time frame the TIROS-Next satellite system will be in orbit. How polar orbiting satellite data are used with future programs should be well defined.

Many different components will impact the STORM Program's operation: radar, mesonet, aircraft systems, flight crew availability, forecast teams, operational configuration of the satellites, lightning strike network, and so forth. Since these must be coupled with the multitude of research objectives, it seems that an "expert system" approach should be developed to help manage resources and to advise those involved with daily operations of the program where "best success" decisions can to be made based on research priorities as well as observing system availability.

8. Areas of Future Research

The PRE-STORM experiment paved the way for additional research and development work in two main areas: 1) operational workstation design, and 2) product development for analysis and forecasting of mesoscale convective systems.

The use of the PC workstation at the PRE-STORM operations center proved to be a feasible method of handling real-time satellite imagery and derived products. Opportunities for future work include higher resolution graphic displays for imagery, faster communications and data processing speeds to improve data throughput, and additional applications software to expand the number of analysis tools for the meteorologist.

Research work has begun with the VAS retrieval data sets for five PRE-STORM case studies. The dates are May 6-7, May 28-29, June 10-11, June 14-15, and June 21-22, 1985. The RISOP (Rapid Interval Satellite Operations) imagery and some of the VAS MSI (multi-spectral imagery) data will be processed with CIRA's IRIS (Interactive Research Imaging System) for these cases. The main research objectives are as follows:

1. To develop products to aid in forecasting mesoscale convective systems, based on VAS retrieval data sets and multi-spectral images combined with conventional satellite imagery.
2. To investigate the utility of bulk thermodynamic parameters derived from VAS data for mesoscale analysis and assessing convective potential in a wide variety of weather situations.
3. To apply VAS data to producing detailed mesoscale analyses of the distribution of sub-convective cloud layer water vapor.

Research work is beginning at CIRA using image products archived from the personal computer workstation as well as from the rapid scan satellite imagery archived at CIRA. The main research areas include:

1. Determination of storm relative vertical wind shear for different type MCS developments;
2. Study of MCS cloud top characteristics, including growth rates and infrared signatures; and
3. Study of VAS multispectral image data to determine the role mid-level dry air plays in the development and evolution of MCS's.

9. Acknowledgements

This report has been supported by NOAA Grants NA84AA-D-00017, "Mesoscale Analysis and Forecast Product Development for Severe Storm Nowcasting" and NA84AA-H-00020, "Research and Development Activities in Support of the NOAA Operational VAS Assessment (NOVA) Program". The authors would also like to thank Sallie Varner for preparing the manuscript.

10. References

- Dedecker, R.G., R.N. Green and H.B. Howell, 1985: VAS data acquisition and processing system for a personal computer. Preprints of The International Conference on Interactive Information and Processing Systems for Meteorology, Oceanography and Hydrology, Los Angeles, CA, January 1985.
- Green, R.N. and J.F. Weaver, 1985: Use of a personal computer workstation for short range forecasting: A case study. Preprints of The 14th Conference on Severe Local Storms, Indianapolis, IN, October - November 1985.
- Smith, W.L., 1983: The retrieval of atmospheric profiler from VAS geostationary radiance observations. J. Atmos. Sci., 40, 2025-2035.