

Indirect Detection of Intentional Chemical Contamination in the Distribution System Using Low Cost Turbidity Sensors

Seongho Cho and Kenneth Carlson

Colorado State University

Kenneth Stutzman

ST-Infonox, San Jose, California

Abstract

Rapid detection of chemical contamination in the distribution system is essential in protecting public health, and using water quality surrogates to signal a contamination event offers the advantage of detecting a large number of chemicals. The concern over using surrogate parameters is whether they offer the ability to detect contaminants at concentrations low enough to prevent serious illness. The best candidates for water quality surrogates are generally thought to be chlorine residual and TOC, with conductivity, pH and turbidity being less sensitive to many chemical contaminants. All of these surrogate measurements have been in direct response to the chemical contaminant itself. This paper describes research on how the indigenous biofilm in the presence of toxic chemicals may provide an effective, indirect surrogate response with either turbidity or UV254. Rotating annular bioreactors and pipe loops were used to quantify the effect that the biofilm has on the turbidity and UV254 measurements. The hypothesis is that, if toxic chemicals are added to the distribution system, the biofilm would die and slough off to an extent that would change the UV254 absorbance and light scattering of the water so that relatively inexpensive monitors could detect the event. In previously documented work, three reactors with 20 PVC coupons in each were used to acclimate the biofilm for at least six weeks. The number of biofilm cells on each coupon was enumerated using automated fluorescence microscopy. The coupons were submersed into beakers with four potential chemical contaminants; aldicarb, cyanide, arsenate and fluoroacetate. The concentration of the contaminants was less than 1 mg/L, a concentration that was shown to be feasible to achieve in a distribution system in previous research. The turbidity was measured after 1, 8 and 48 minutes to determine the response time of the biofilm to the chemicals. In all cases, the turbidity significantly increased after one minute and in most cases continued to increase at the longer times. The batch data indicate that turbidity may be a useful surrogate monitor for chemical contamination due to die-off of the indigenous biofilms. Biofilm slough-off and increased turbidity response occurred in the present study in which a commonly used turbidity monitor and a simple, inexpensive turbidity sensor monitored a simulated distribution system inoculated with five common industrial chemical contaminants. We will detail the results of the pipe loop study at the conference and describe the inexpensive turbidity monitor that has been developed.

1. Introduction

During the distribution of drinking water, bacterial regrowth as biofilm fueled by the presence of organic substances can lead to a deterioration of water quality, amplification of corrosion, generation of bad tastes and odors, and proliferation of macroinvertebrates (Volk and LeChevalier, 1999). Studies in pilot-scale systems have shown that bacterial growth as biofilm within drinking

water distribution systems can seriously affect the quality of drinking water (Rasmus et al., 2002); therefore, to protect public health, it is essential to be able to rapidly detect changes in biofilm presence in the distribution system.

1.1 Introduction of microorganism in distribution system

Biofilm is recognized as indigenous in a normal aquatic system and can exist in all distribution systems containing properly treated, but non-sterile, water (U.S. EPA, 1992). Living microorganisms and nutrients enter drinking water distribution systems with raw water during water treatment failures or from pipe breaks or leaks, backflow, and cross-connections (Khan et al., 2001). Microbiological contamination also can occur via uncovered storage tanks and during water main installation and repair (Kirmeyer et al., 2001). Even those water systems observing excellent sanitary practices for main breaks and repair experience contaminant entry into the distribution system (LeChevallier, 1999).

1.2 Definition of biofilm

For a number of years, biofilm was generally regarded as "cells immobilized at a substratum and frequently embedded in an organic polymer matrix of microbial origin." A more-universal definition - "matrix-enclosed bacterial populations adherent to each other and/or to surfaces or interfaces" - better suits application of the term to all ecological, industrial, and medical situations, and in 1995, biofilm was defined as, "microbial cells, attached to a substratum, and immobilized in a three-dimensional matrix of extracellular polymers enabling the formation of an independent functioning ecosystem, homeostatically regulated" (Precival et al., 2000).

1.3 Formation of biofilm

Biofilms can be found virtually anywhere a surface comes into contact with the water in a distribution system. In water distribution system pipelines, biofilms form when microbial cells attach to pipe surfaces and multiply to form a film or slime layer on the pipe. This growth is a complex and dynamic microenvironment, incorporating processes such as metabolism, growth and product formation, and finally detachment, erosion, or "sloughing" of the biofilm from the surface. The roughness of the pipe wall, usually a factor of the pipe material and condition, is a key condition influencing both attachment and detachment of biofilm. In fact, pipe material may have more influence on biofilm growth potential than the level of organic matter in the system.

1.4 Process of biofilm formation

While biofilm formation is considered to be complex, it can be summarized as a five-stage process (Precival et al., 2000):

- a. Development of a surface-conditioning film: A clean, uncontaminated surface can be conditioned by the transport medium, i.e. water, containing organic substances and microbial cells in as little as 15 minutes.

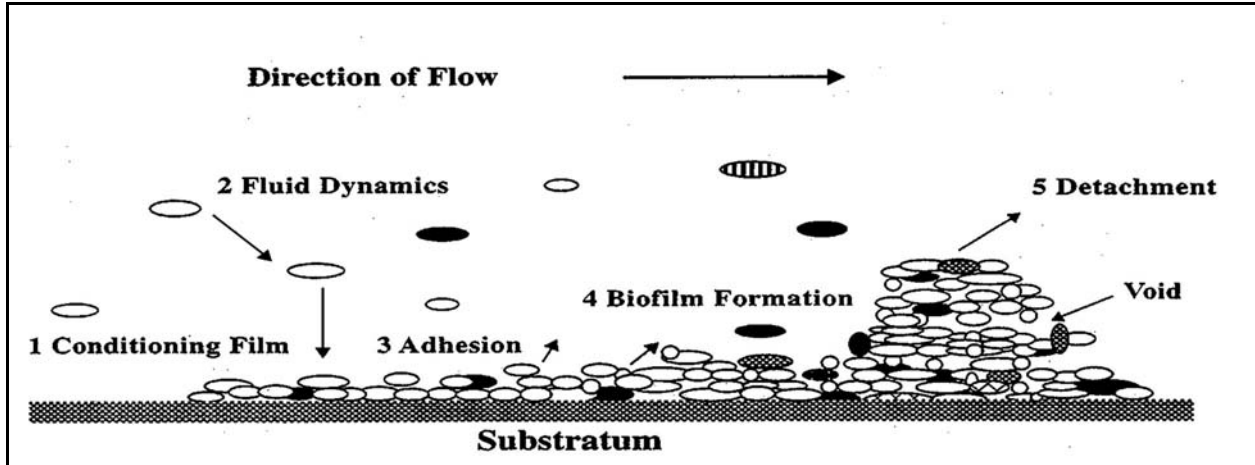

Figure 1-1 Biofilm Formation Diagram (from Precival et al., 2000)]

- b. Events that bring the organisms into close proximity with the surface: Transport of organisms to the surface can be through laminar flow or turbulent flow. Temperature and gravity typically dictate the speed of flow.
- c. Adhesion, either reversible or irreversible sorption: Reversible adhesion is an initial, weak attachment of microbial cells to a surface. Irreversible adhesion establishes a permanent bonding of the microorganisms with the surface and requires mechanical or chemical treatment for removal.
- d. Growth and division of the organisms with the colonization of the surface, microcolony formation and biofilm formation: There are a number of parameters that affect the development of biofilm, such as temperature, hydrodynamic conditions, nutrient availability, roughness, and pH.
- e. Detachment: The five likely means of biofilm detachment include: erosion, for a single cell; sloughing for clusters of cells; abrasion; human intervention; and predator grazing. Erosion is the removal of small particles of biofilms as a result of shear forces. Sloughing is a random and discrete process, involving the detachment of large particles of biofilm. Abrasion is caused by the collision of solid particles with the biofilm, and human intervention involves detachment of the biofilm by chemical or physical means. Predator grazing is the consumption of biofilms by organisms such as protozoa, snails, and worms.

1.5 Factors affecting biofilm accumulation

Previous investigation assessed the impact of various factors on biofilm accumulation by measuring pseudo steady-state biofilm HPC (Heterotrophic Plate Count) levels (Ollos et al., 2003). The most significant factor was found to be the presence of disinfectant residual - increasing the free chlorine residual from 0 to 0.5 mg/L reduced biofilm HPC levels, measured in cfu/cm², by about four orders of magnitude. High chloramines residual (2.0 mg/L) also significantly suppressed biofilm HPC levels.

The presence of easily biodegradable organic matter (BOM) also was found to be significant, in that it influenced the impact of other factors such as

flow velocity, shear force, temperature, pipe material, and substratum. In the absence of BOM, HPC increased with higher shear and remained unaffected by temperature change. In the presence of BOM, the temperature effect was important at lower shear stress. The condition leading to the highest levels of biofilm HPC was a high level of easily degradable BOM in the absence of a disinfectant. The fact that shear was important under some conditions indicates that mass transfer might be limited in some circumstances.

1.6 Measurement of biofilm formation

Biofilm control is recognized as an important part of the operation and maintenance of drinking water plants and distribution systems (Volk and LeChevalier, 1999). The classical approach to estimating biofilm growth in drinking water distribution system is to measure the biofilm formation rate. This process is laborious and time consuming because it requires frequent sampling in piping systems that are, typically, extensive and complex. To streamline the process, numerical models have been developed to help predict biofilm growth (Butterfield et al., 2002). Another possible means of determining biofilm growth rates is to estimate the release rate of bacteria from the biofilm.

1.7 Using turbidity to track biofilm, and distribution system, changes

Turbidity, technically, is a measure of the scatter of light by suspended particles in water; in practical terms, it is often thought of as a measure of the cloudiness of water. Turbidity is caused not only by total suspended solids (TSS) such as clay, silt, and organic matter but also by plankton and other microscopic organisms. While turbidity itself is not necessarily a health concern, higher levels of turbidity reflect particulate presence that can interfere with disinfection and provide a medium for microbial growth. (Murphy, USGS)

This study looks at using turbidity to monitor the presence of detached biofilm which, of itself, can pose a health concern and also signals changes in the distribution system conditions. The investigators propose taking advantage of the fact that biofilm is a natural consequence of distribution system conditions and examining whether changes in distribution system conditions that alter biofilm integrity and result in detachment and sloughing of biomass - such as the introduction of toxic chemicals - might be signaled by increased turbidity levels in the system water.

2. Methods and Materials

2.1 Bench-Scale Distribution System Design

The bench-scale distribution system used in the study is shown in Figure 2-2. This design incorporates two different influents, tap water direct from the municipal water distribution system and tap water with one of five contaminants injected by an 8.0-rpm peristaltic pump. The toxicity of the volatile chemicals injected into the system required a ventilation hood, which also minimized exposure when the hazardous waste was collected at drain.



Figure 2-1 Bench-Scale Distribution System

This continuously flowing loop system constructed with 3/4-inch PVC pipe throughout was utilized because it is more representative of an actual water distribution system than the rotating annular bioreactor (RAB) model used in other studies. The typical RAB test uses one liter of contaminant solution in a batch setup with test coupons representing system surfaces submersed into the beakers. In the current study, a PVC coupon was inserted inline with the pipe to collect biofilm. Using Hach DR/3000 Spectrophotometer, the turbidity of RAB test was measured

Figure 2-2 details the bench-scale distribution system. The main system line (■) was 21 feet long. Flow rate (■) was 6 gal/hour in each pipe. Pipe unions built into the line allowed easy insertion and removal of the three coupons inserted in each pipe (■) to accumulate biofilm. An ST-Infinox Micro Sensor (■) measuring pH, temperature, and turbidity, a Hach 1720 D on-line Turbidimeter, and an Optek UV 254nm Sensor monitored the continuously flowing water in the simulated distribution system. Valves (not shown in the diagram) allowed flow direction change between the pipe with tap water (■) and the pipe with contaminated water (■). Only contaminated water circulated through the UV and turbidity instruments was collected as waste water.

2.2 Contaminant selection

Key properties of credible threat contaminants are:

- high toxicity
- high water solubility
- chemical and physical stability
- a lack of taste, color and odor
- a low chance of detection with normal analytical methods

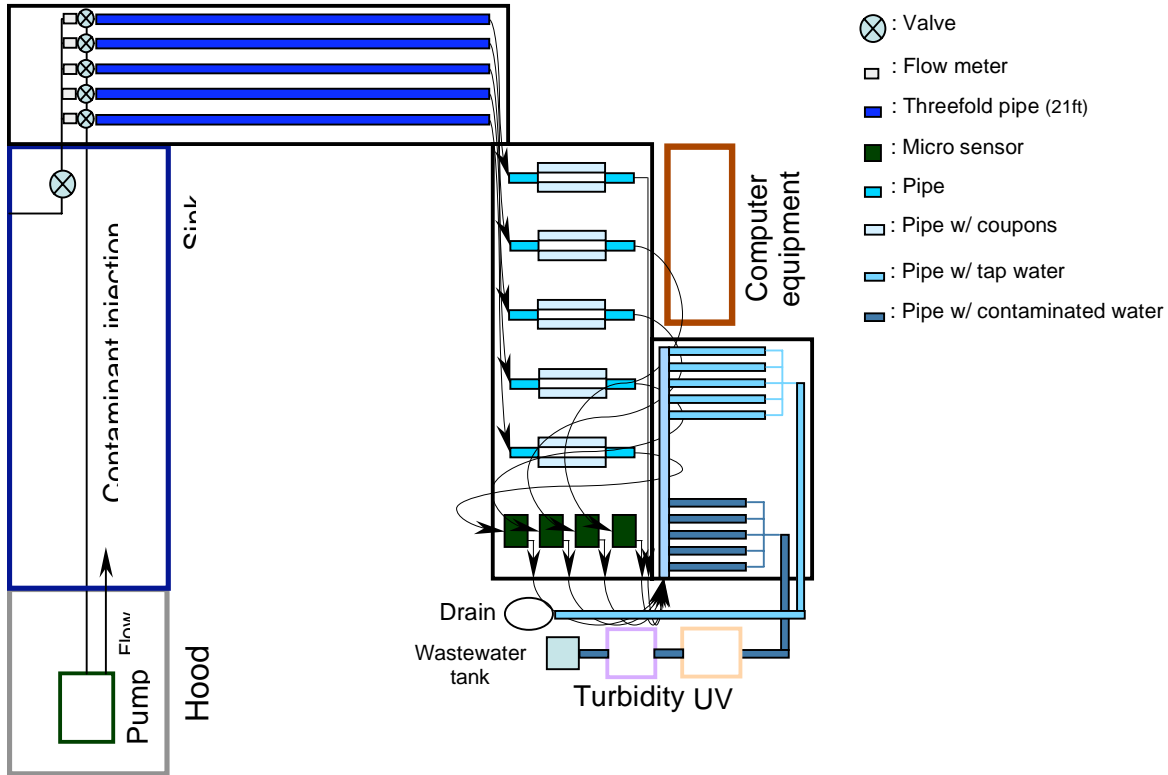

According to Khan (Khan et al., 2000), chemical contaminants also possess these criteria:

- already known to be weaponized
- available to potential terrorists
- likely to cause major morbidity or mortality
- potential of causing public panic and social disruption
- requiring special action for public health preparedness

The National Research Council (NRC, 2002) addresses morbidity and mortality, or toxicity, and focuses on cholinesterase inhibitors, including insecticides (e.g. aldicarb), which act like nerve agents and are persistent in water. The US Army Center for Health Promotion and Preventive Medicine listed sodium fluoroacetate as priority potential chemical threat agents (Burrows et al., 1997). The following specific chemical compounds were used in this investigation.

Aldicarb

Aldicarb is directly toxic through oral, dermal, and inhalation routes. It is toxic through secondary poisoning - when plants systemically exposed are consumed or when exposed insects, rodents, and birds are consumed by predators and scavengers. Aldicarb is highly soluble in water, soluble in acetone, zylene, ethyl, ether, toluene, and other organic solvents, and is highly mobile in soil. Levels of aldicarb in drinking water exceeding the health advisory level of 10 ppb established by the Office of Drinking Water at EPA have been recorded in couple states in U.S.

Nicotine

Nicotine is usually obtained from *Nicotiana tabacum*. Nicotine is one of the more than 4,000 chemicals found in the smoke from tobacco products such as cigarettes, cigars, and pipes. Nicotine is a naturally occurring colorless liquid that turns brown and acquires the odor of tobacco when exposed to air.

Cycloheximide

Actidione (Cycloheximide) is an antibiotic that acts as an inhibitor of protein synthesis in eukaryotes but not prokaryotes. Cycloheximide is an odorless, white, crystalline powder used in hospital and research laboratories as an antibiotic, a protein synthesis inhibitor, or a plant growth regulator. Cycloheximide also has broader agricultural use as a fungicide, but such use is being discontinued due to the recent findings of birth defects at low doses in animals.

Sodium Arsenate

Sodium arsenate is a pentavalent form of inorganic arsenic. It is a heptahydrate and normally exists as colorless crystals with no discernible odor. Inorganic arsenical compounds have been classified as Class A oncogens, demonstrating positive oncogenic effects based on sufficient human epidemiological evidence.

Sodium Fluoroacetate

Sodium fluoroacetate, also commonly known as compound 1080, sodium monofluoroacetate, fratol, furatol, ratbane, and yasoknock, is a rodenticide. Fluoroacetic acid differs from the fluoroacetate ion that makes up sodium fluoroacetate only in the addition of a hydrogen atom, $C_2H_3FO_2$ or as a more protonated form.

2.3 Measurement of contaminant-instrument response

After the biofilm was established in the 3/4 in PVC pipe for minimum 6-weeks and before contaminant injection, one coupon was removed from each pipe. This first coupon provided a baseline cell count ($t=0$) as described in section 2.4. The other two coupons were taken from the pipe at after one and fifteen minutes following contaminant injection to determine biofilm response to chemical exposure.

Turbidity and UV were monitored prior to injection around three and half minutes and documented after one, fifteen minutes after contaminant injection to identify turbidity change from baseline. This comparison would provide the first indication that toxicity-induced sloughing might increase turbidity measurements in a distribution system.

2.4 Counting cells on the PVC coupon

Counting bacterial cells on the PVC coupon entailed staining of bacteria, preparing bacterial suspensions, and viewing the stained samples.

Equipment needed

- Epifluorescence microscope
- Optical Filters

- excitation/emission = 480/500 nm for SYTO 9 (Nikon B-2A)
- excitation/emission = 520/635 nm for propidium iodide (Nikon G-2E/C)
- Vortex
- Sterile 25mm Luer-Lock syringe filter holder (Life Sciences)
- 60ml Luer-Lock syringe.
- 5ml Luer-Lock syringe with needle.
- Sterile 25X200mm screw cap test tube.
- 10 μ l pipette
- 1000 μ l pipette
- Sterile Coupon scraping tool
- Forceps

Materials needed

- Live/Dead[®] *BacLight*[™] Bacterial viability kit L7012 containing:
 - SYTO 9 dye, 3.34mM, 300 μ L solution in DMSO
 - Propidium iodide, 20mM, 300 μ L solution in DMSO
 - *BacLight* mounting oil, 10 μ L
- Sterile 0.85% NaCl solution
- 25 mm diameter 0.22 micron, black, polycarbonate membrane filter (Osmonics inc.)
- Sterile 2ml centrifuge tube

Staining of bacteria

For each of the three filter membranes:

1. Add 1.5 μ l of SYTO 9 and 1.5 μ l Propidium iodide in a 2ml centrifuge tube containing 1ml of sterile 0.85% NaCl solution.
2. Take up the stain solution into the 5ml syringe.
3. Slowly pass the stain solution through the filter holder containing the membrane filter.
4. Incubate filter holder containing filter and stain solution at room temperature in the dark for 15 minutes.
5. Pass an additional 5ml of sterile 0.85% NaCl solution through the filter holder to remove excess stain.
6. Place one drop of mounting oil on microscope slide.
7. With forceps remove the membrane filter from the holder and place on microscope slide.
8. Place one more drop of mounting oil onto filter surface and cover with cover slip.

Preparation of bacterial suspensions

1. Place coupon in the large test tube containing 55ml solution containing 0.85% NaCl.
2. Use coupon scraping tool to gently scrape the biofilm from the coupon. Scrape up and down on the coupon 2 times on each side.
3. Remove the scraping tool and coupon from the test tube.

4. Vortex the test tube for 2 minutes to disperse the biofilm throughout the solution.
5. Poor the solution into a 60ml Luer-Lock syringe.
6. Attach the filter holder containing the 0.22 micron membrane filter to the syringe.
7. Filter all of the solution through the filter

Viewing the samples

1. View the slides using the 40X objective lens.
2. Capture images of 9 view fields on each filter from the following locations:
3. Upper left view field should be 4.5mm from the edges of the cover slip, this can be measured using the measurements at the edges of the stage. All other view fields should be spaced 4.5mm from other fields and the cover slip edges.
4. Each View field should have an image taken using both the B-2A and the G-2E/C optical filters.
5. When counting cells in each view field only well defined cells (cocci or bacilli), larger than approximately 1_μ are to be counted.

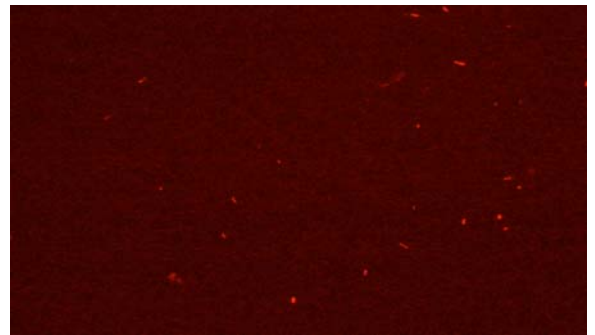
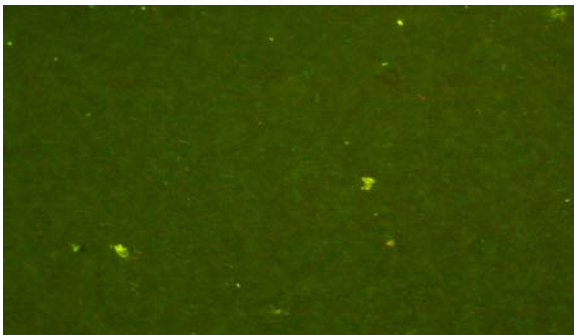

Live cells fluoresced green, dead cells fluoresced red as indicated in Figure 2-3.
Figure 2-3 Fluorescing Live and Dead Cells under UV Light

2.5 Determining log-removal of cells

To determine the log removal of cells from the coupons (y), the negative log was taken of the live cell count after exposure to the contaminant in the pipe at one minute and at 15 minutes (ct), divided by the live cell count (c_0) before exposure to the contaminant: $y = -\log(ct/c_0)$.

3. Results and Discussion

3.1 Documented RAB Results

Figure 3-1 displays documented increase in turbidity after contaminants were added to the bioreactor at different concentrations. As shown, the turbidity increased markedly and quickly after the contaminants were added. It is expected that the reactors contained different quantities of biomass on the coupons, hence the differences in instrument response that did not necessarily correlate to the concentration of the contaminant. In cases where there is a decrease in turbidity

after increased exposure time to the contaminant, it is thought that perhaps there was less biomass available on the coupon after initial exposure to the contaminant. (Byer, 2004)

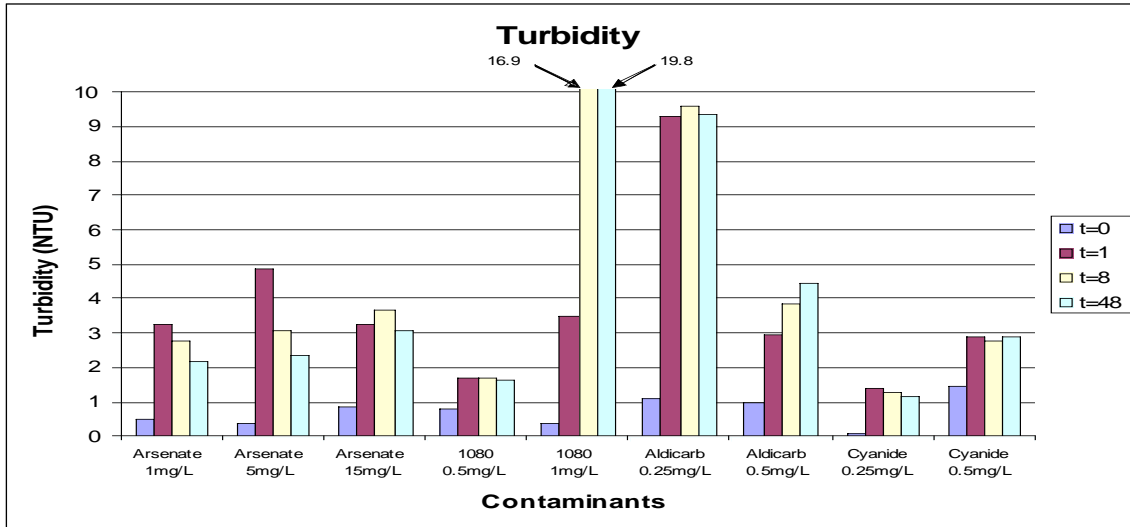

Figure 3-1 Turbidity Response from Biofilm Exposure to Contaminants – RAB

To correlate the increased turbidity readings in the reactor water to coupon exposure to contaminants, the cells on the coupons were quantified before and after exposure to the contaminants. Figure 3-2 displays the log-removal of cells after exposure to the contaminants. The three t = 48 minute exposures that had log removal values of 2.0 were actually much larger, as the cell count for those three exposures were reduced to zero, making a log removal calculation impossible, or theoretically infinite, resulting in 100% removal. For comparison purposes, a log removal of one implies 90% removal, and a log removal of 0.5 provides 66% removal. The expected trend would be for an increased log removal of cells as the exposure time and contaminant concentration increases. In cases where this does not happen, consideration should be given to the variance in biomass on the individual coupons, remembering that one coupon was pulled at t = 0. (Byer, 2004)

Figure 3-2 clearly indicates a direct relationship between the concentration of the contaminant and cell removal for sodium arsenate and aldicarb. 1080 and sodium cyanide do not share a similar relationship between contaminant concentration and log removal rates, likely due to variance in cell counts per coupon. Again, in most cases, the coupons were shown to be homogeneous, but when they weren't, it impacted the results. (Byer, 2004)

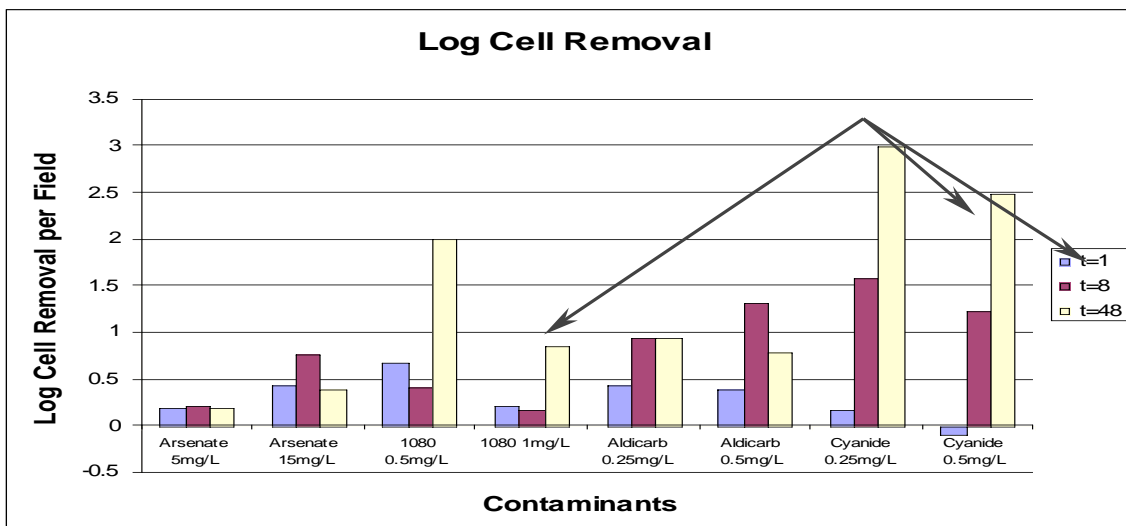

Figure 3-2 Toxicity-Induced Cell Death per Contaminant Concentration – RAB

3.2 Bench-Scale Distribution System Results

Figures 3-3 through 3-5 display the change in turbidity measured by the on-line turbidimeter, UV absorption, and turbidity as signaled by the Micro Sensor Unit (MSU), respectively, after the contaminants were added to pipes at different concentrations. As shown, turbidity response to injection varied among contaminants. In most cases, the turbidity increased at $t = 1$ and decreased at $t = 15$ except after injection of 0.25ppm nicotine and 0.5ppm cycloheximide. It is expected that the coupons in the different pipes contained different quantities of biomass, hence the differences in instrument response that may not necessarily be correlated to the concentration of the contaminant. In cases where there is a decrease in turbidity after increased exposure time to the contaminant, it is thought that perhaps there was less biomass available on the coupon to be sloughed off after initial exposure to the contaminant.

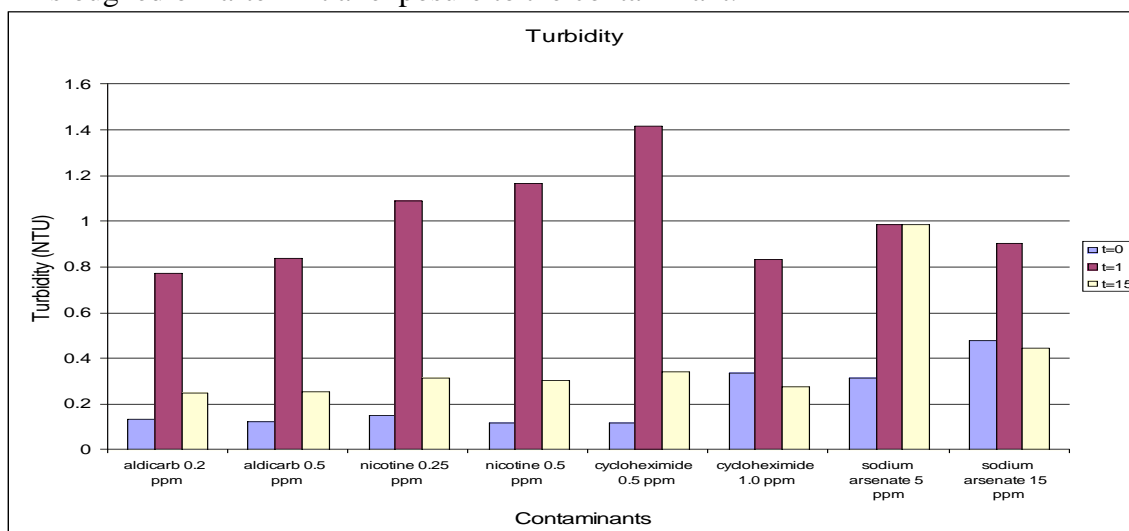

Figure 3-3 Turbidity Response (On-line Turbidimeter) from Biofilm Exposure to Contaminants

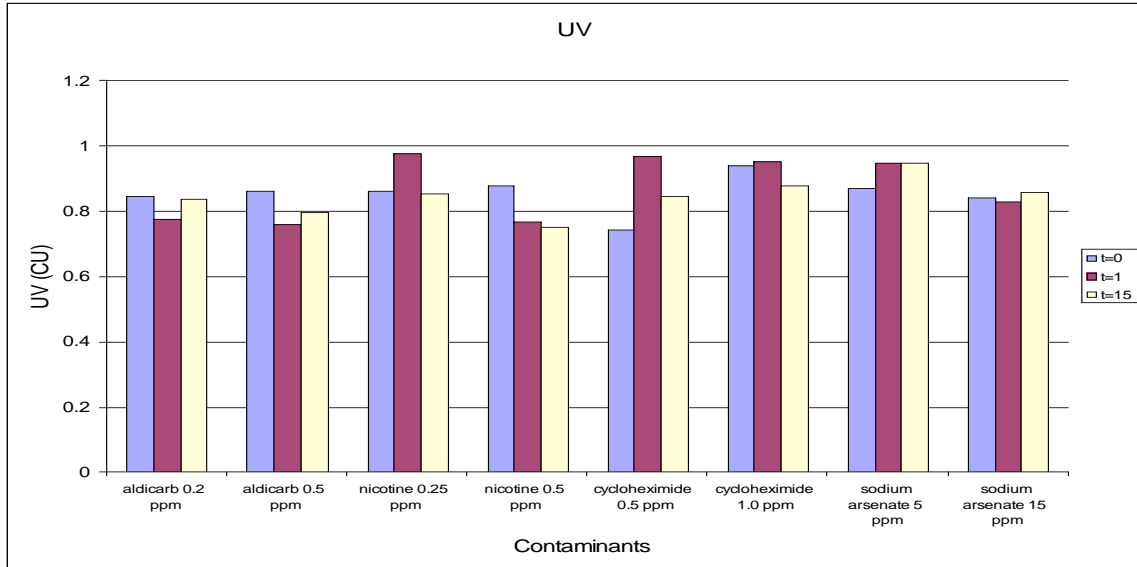

Figure 3-4 UV Response from Biofilm Exposure to Contaminants

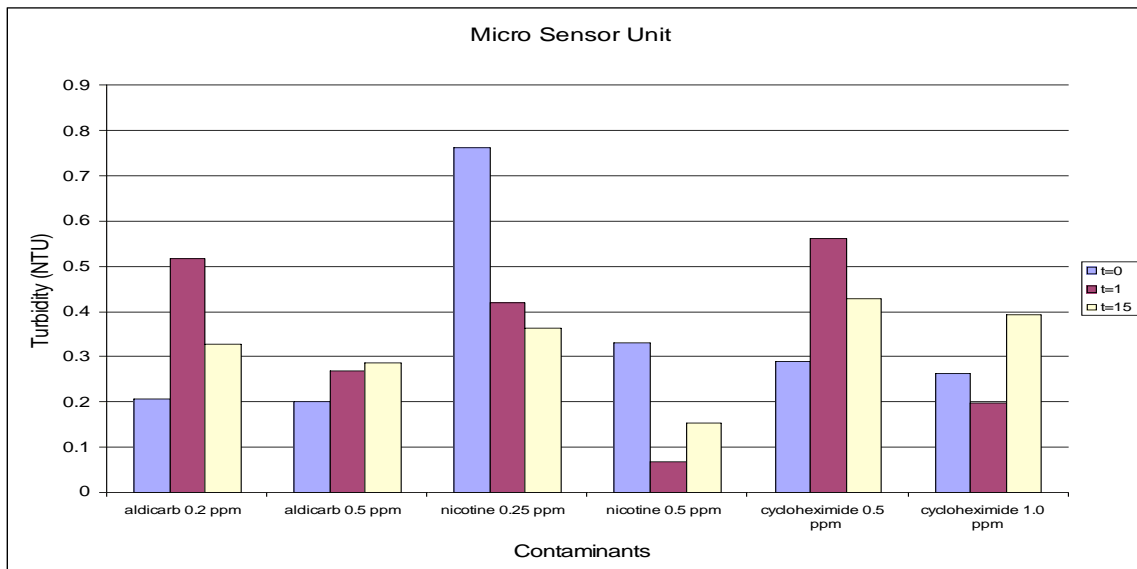

Figure 3-5 Turbidity response (MSU) from Biofilm Exposure to Contaminants

Figures 3-6 through 3-10 each show the response from the on-line turbidimeter, the UV254 unit, and the micro sensor unit (MSU), after the contaminants were added to pipes at different concentrations. Of the two turbidity sensors, the on-line turbidimeter showed less noise; it responded with a higher peak value at t = 1 and subsequent, lesser peaks. The MSU turbidity response shows one strong peak with other peaks not comparable to those of the turbidimeter. In most of the UV data, spikes after the initial peak varied, and response to contaminant was less marked than turbidity response. It is likely variation in all responses reflect the process of biofilm attachment and detachment.

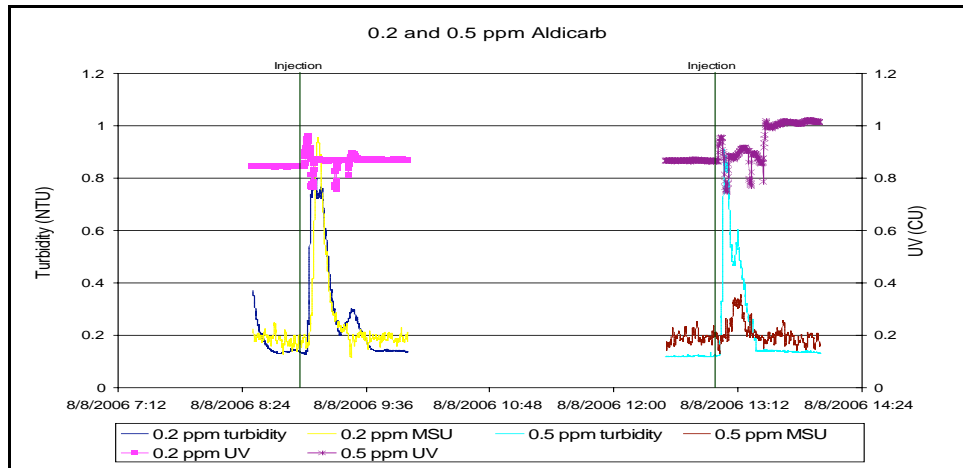

Figure 3-6 Turbidity and UV254 Absorption Response from Biofilm Exposure to Aldicarb

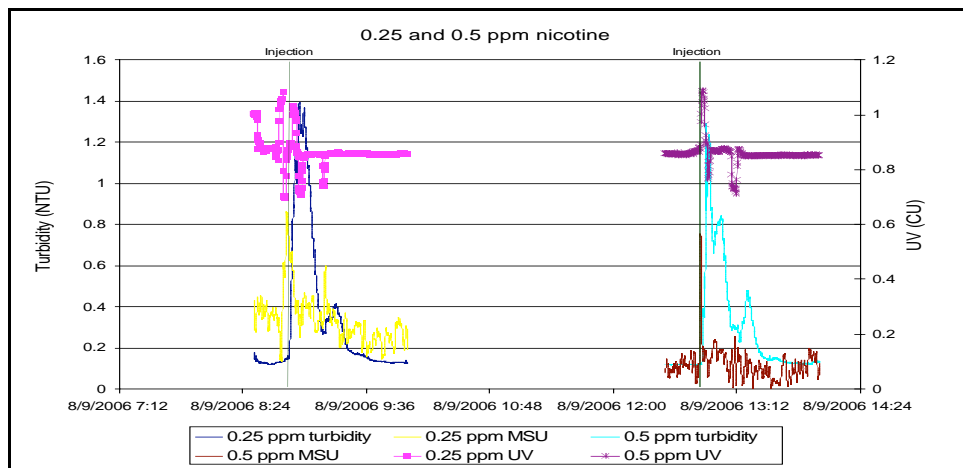

Figure 3-7 Turbidity and UV254 Absorption Response from Biofilm Exposure to Nicotine

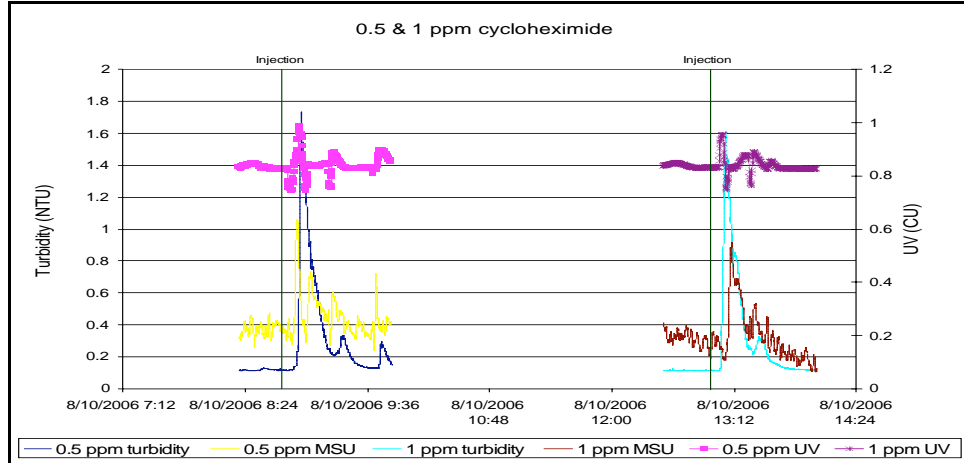

Figure 3-8 Turbidity and UV254 Absorption Response from Biofilm Exposure to Cycloheximide

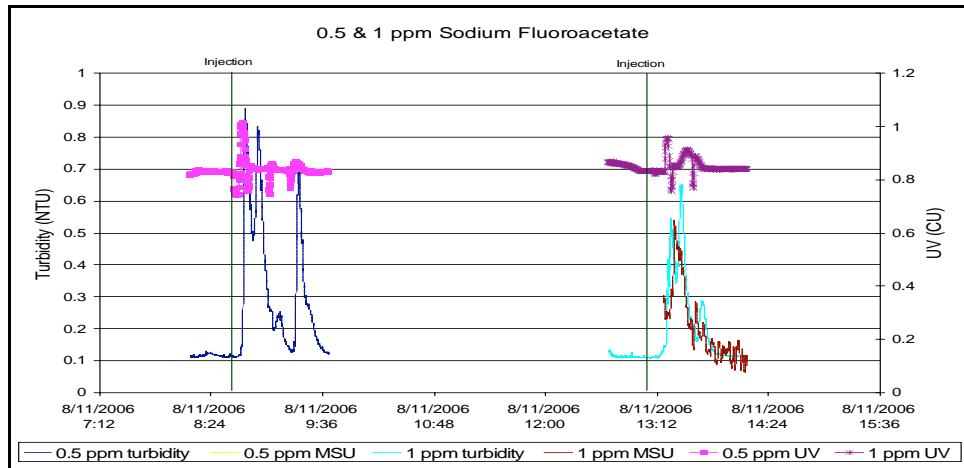

Figure 3-9 Turbidity and UV254 Absorption Response from Biofilm Exposure to Sodium Fluoroacetate

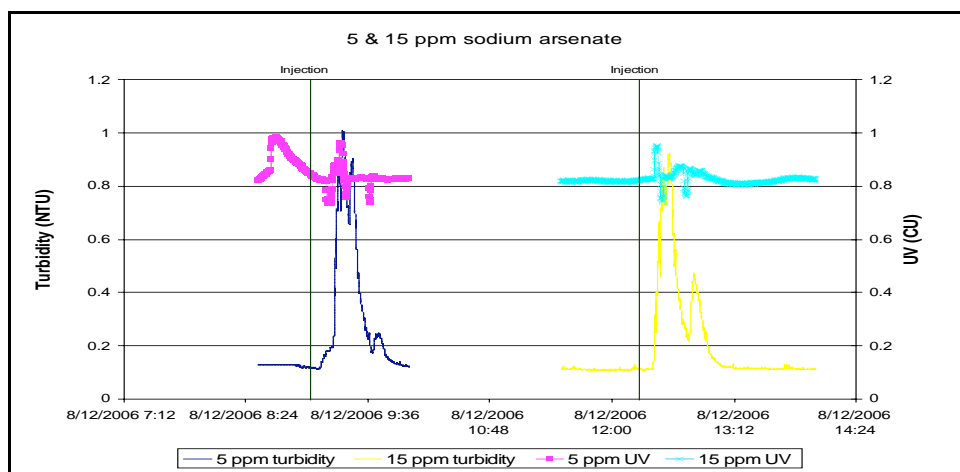

Figure 3-10 Turbidity and UV254 Absorption Response from Biofilm Exposure to Sodium Arsenate

Figures 3-11 and 3-12 display the log-removal of live and dead cells in the current study after exposure to the contaminants. The expected trend would be for an increased log removal of cells as the exposure time and contaminant concentration increases. In cases where this does not happen, consideration should be given to the variance in biomass on the individual coupons, remembering that one coupon was pulled at $t = 0$.

Figure 3-11 clearly indicates a direct relationship between the concentration of the contaminant and cell removal for nicotine and aldicarb. Cycloheximide and arsenate do not exhibit a similar relationship between contaminant concentration and log removal rates, likely due to variance in cell counts per coupon. Again, in most cases, the coupons were shown to be homogeneous, but when they weren't, it impacted the results. Dead cell log removal results do not reflect a relationship between the concentration of the contaminant and cell removal.

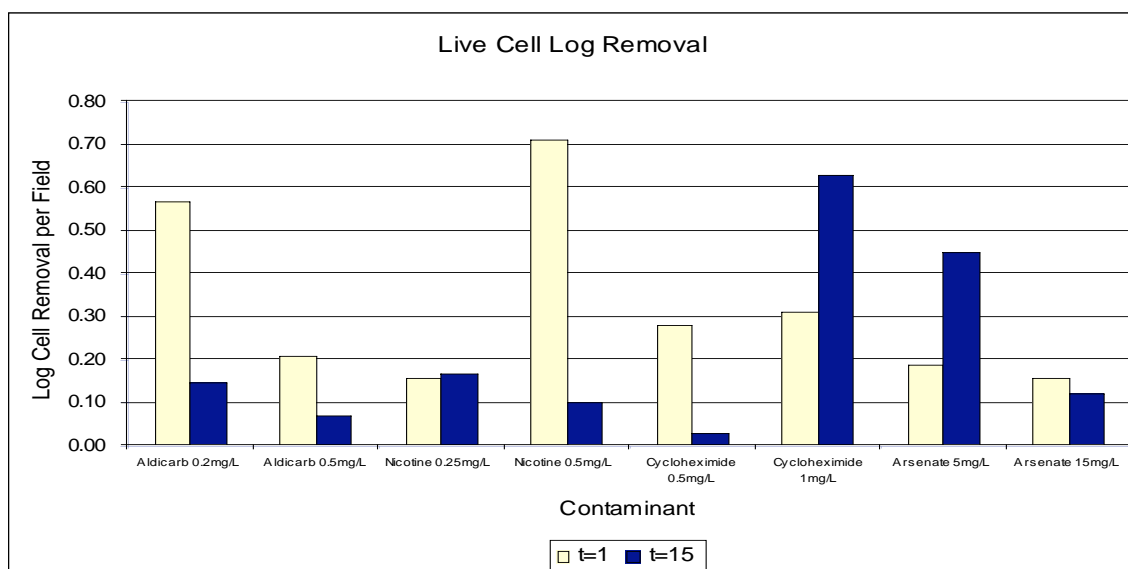

Figure 3-11 Toxicity-Induced Cell Death for Each Contaminant Concentration

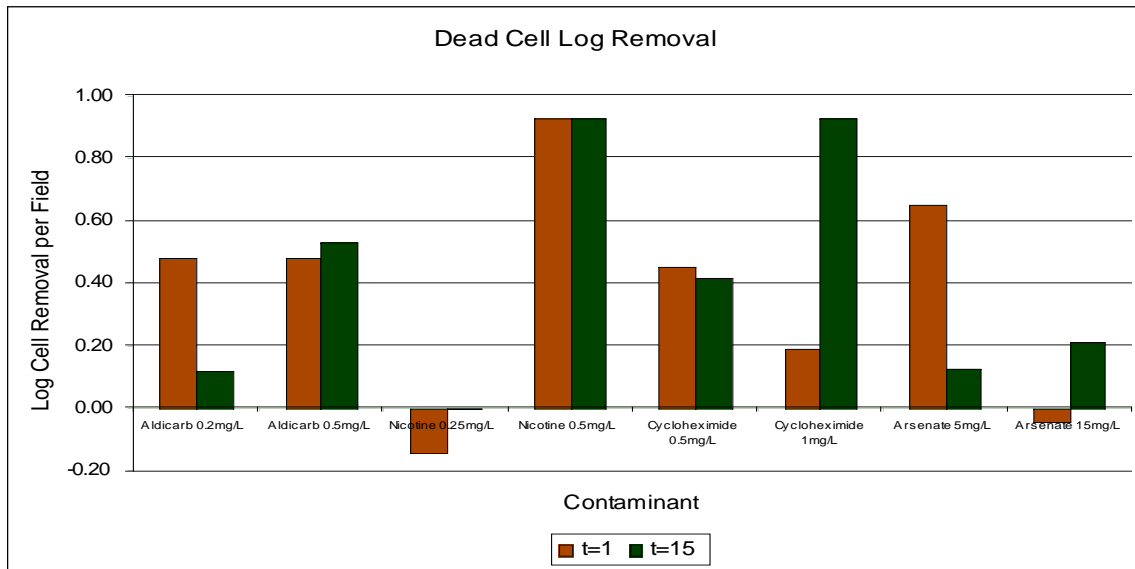

Figure 3-12 Toxicity-Induced Cell Death for Each Contaminant Concentration

Comparing the documented batch reactor test results and those from the current bench-scale distribution system test, turbidity response to aldicarb was similar; turbidity response to sodium arsenate was not. However, log-removal data were similar, except for those with sodium arsenate at 5ppm.

4. Conclusions

This study considered the impact of chemical contamination on biofilm sloughing and the resulting change in measured turbidity and UV absorption with different contaminants, concentrations, and residual times. The interaction between toxic industrial chemicals and biofilm in the distribution system resulted in cell death and the sloughing off of biomass. As was demonstrated in the cell count experiments, there was a correlation between introduction of a chemical contaminant and the log-removal of cells from inline PVC coupons. It was further demonstrated that the sloughed-off biomass contributed to a measurable change in turbidity and UV254 absorption, with a greater response shown in turbidity for all contamination events, including those at lower concentrations. Increasing turbidity reduced the limit of detection of chemical contaminants by increasing the signal to noise ratio of the contaminant-instrument response. The results of this study emphasize the value of on-line turbidity monitoring in the water distribution system.

Results further emphasize that biofilm in the distribution system might be a key tool in using on-line turbidity monitoring to detect the presence of toxic industrial chemicals. This relationship can help provide the early warning needed to protect public health in the event of distribution system chemical contamination.

5. References

- Volk, C. J., and LeChevallier, M.W. (1999). "Impacts of the reduction of nutrient levels on bacterial water quality in distribution systems," *Applied and Environ Micro Nov*: 4957-4966.
- Rasmus, B.H., Albrechtsen, H.J., Arvin, E., and Claus, J. (2002). "Bulk water phase and biofilm growth in drinking water at low nutrient conditions," *Water Research* 36:4477-4486.
- US Environmental Protection Agency (1992). *Control of Biofilm Growth in Drinking Water Distribution Systems*, EPA Publication 625/R-92/001.
- Khan, A.S., Swerdlow, D.L., and Juranek, D.D. (2001), "Precautions against Biological and Chemical Terrorism Directed at Food and Water Supplies," *Public Health Reports*, 116:3-12.
- Kirmeyer, G.J., Friedman, M., Marte, K.D., How, D., LeChevallier, M., Abbaszadegan, M., Karim, M., Funk, J., and Harbour, J. (2001). *Pathogen Intrusion into The Distribution System*, AWWARF, CO.
- LeChevallier, M.W. (1999). "The Case for Maintaining a Disinfectant Residual," *Journal of the American Water Works Association*, 91:1:86-94.
- Precival, S.L., Walker, J.T., and Hunter, P.R. (2000). *Microbiological Aspects of Biofilms and Drinking Water*, CRC Press, Florida.
- Butterfield, P.W., Camper, A. K., Ellis, B.D., and Jones, W.L. (2002). "Chlorination of model drinking water biofilm: implications for growth and organic carbon removal," *Water Research* 36:4391-4405.
- Ollos, P.J., Huck, P.M., and Slawson, R.M. (2003). "Factors Affecting Biofilm Accumulation in Model Distribution Systems," *Journal AWWA* 95:1:87-97
- Murphy, S., "General Information on Turbidity," City of Boulder/USGS Water Quality Monitoring (<http://bcn.boulder.co.us/basin/data/FECAL/info/Turb.html>).
- Khan, A.S., Levitt, A.M., and Sage, M.J., (2000). "Biological and Chemical Terrorism: Strategic Plan for Preparedness and Response," *Morbidity and Mortality Weekly Report: MMWR/Center for Disease Control*, 49(RR04):1-14.
- National Research Council (2002). *Making the Nation Safer: The Role of Science and Technology in Countering Terrorism*, The National Academic Press, Washington D.C.
- Burrows, W.D., Valcik, J. A., and Setzinger, A. (1997). "National and Terrorist Threats to Drinking Water Systems," presented at the American Defense Preparedness Association 23rd Environmental Symposium and Exhibition, New Orleans, LA.
- Byer, D.E. (2004). "Utilizing Routine Water Quality Instruments for Monitoring Distribution System Security," Dissertation at Colorado State University on Summer 2004