

DISSERTATION

PROPERTIES OF TAUTOLOGICAL CLASSES AND THEIR INTERSECTIONS

Submitted by

Vance T. Blankers

Department of Mathematics

In partial fulfillment of the requirements

For the Degree of Doctor of Philosophy

Colorado State University

Fort Collins, Colorado

Spring 2019

Doctoral Committee:

Advisor: Renzo Cavalieri

Jeff Achter

Rachel Pries

Mark Shoemaker

Kristin Heineman

Copyright by Vance T. Blankers 2019

All Rights Reserved

ABSTRACT

PROPERTIES OF TAUTOLOGICAL CLASSES AND THEIR INTERSECTIONS

The tautological ring of the moduli space of curves is an object of interest to algebraic geometers in Gromov-Witten theory and enumerative geometry more broadly. The intersection theory of this ring has a highly combinatorial structure, and we develop and exploit this structure for several ends. First, in Chapter 2 we show that hyperelliptic loci are rigid and extremal in the cone of effective classes on the moduli space of curves in genus two, while establishing the skeleton for similar results in higher genus. In Chapter 3 we connect the intersection theory of three families of important tautological classes (ψ -, ω -, and κ -classes) at both the cycle and numerical level. We also show Witten's conjecture holds for κ -classes and reformulate the Virasoro operators in terms of κ -classes, allowing us to effectively compute relations in the κ -class subring. Finally, in Chapter 4 we generalize the results of the previous chapter to weighted ψ -classes on Hassett spaces.

ACKNOWLEDGEMENTS

My deepest gratitude belongs with Renzo for his constant support and guidance the last six years. He has been an unfaltering source of inspiration and encouragement in both my professional and personal life, through the success and failures, the ups and downs. I cannot possibly thank him enough for everything.

I am thankful for the incredible love and support of my parents and the rest of my family. Life as a graduate student is often challenging, and they were unwavering in their practical and emotional reassurance and support. I appreciate as well their patience as they watched me pursue a professional route completely foreign to them; despite their lack of familiarity with the academic career path, they made every possible effort to encourage and learn about it.

Thank you to the entire math department at CSU and in particular to my fellow graduate students. The community among students at CSU is unbelievably collaborative, encouraging, and challenging. The students who came before me were wonderful example-setters and role models who showed me what was possible, and the ones who came after me continually remind me that I still have so much room for learning and growth. In particular I would like to thank Rachel Neville and Michael Capps, whose frequent discussions on both life and math have had enormous influence on me personally and professionally.

Finally, thank you to my all of my friends and my family, my colleagues and my acquaintances, my students and my teachers, and everyone whose life has touched my own. This dissertation is the sum of your support, love, and encouragement; if it were possible, I would list all of you as coauthors. I have been beyond lucky to know and be influenced by every one of you, and I am continually honored and humbled to have all of you as a part of my life.

DEDICATION

To the teachers who believed in me.

TABLE OF CONTENTS

	ABSTRACT	ii
	ACKNOWLEDGEMENTS	iii
	DEDICATION	iv
	LIST OF FIGURES	vi
Chapter 1	Introduction and Background	1
1.1	Motivation and Structure	1
1.2	Moduli of Curves	3
1.3	Important Tautological Classes	6
1.4	Intersection Theory on $\overline{\mathcal{M}}_{g,n}$	11
Chapter 2	Hyperelliptic Loci	13
2.1	Additional Background	13
2.2	Definition and Theorem	17
2.3	Higher Genus Results	25
Chapter 3	ω -classes and κ -classes	27
3.1	Cycle and Numerical Theorems	27
3.2	Generating Functions and Differential Operators	31
3.3	Change of Variables	35
3.4	Virasoro Relations for the κ -Potential	37
3.5	Recursions for κ -Classes	49
Chapter 4	Hassett Space Intersections	51
4.1	Definition and Basic Results	51
4.2	Cycle Theorem for Weighted ψ -classes	56
4.3	Hassett Potentials and Operators	63
4.4	Changes of Variables	65
	Bibliography	69

LIST OF FIGURES

1.1	Decorated divisor	6
2.1	General elements of $W_{2,P}$ and $\gamma_{1,P}$	15
2.2	Admissible cover example	16
2.3	General element of hyperbolic locus	18
2.4	Specific point in $\overline{\mathcal{M}}_{0,n+5}$	19
3.1	Pinwheel dual graph	28
3.2	Dual graphs in example	29
4.1	Reduction morphism on curves	53
4.2	Example dual graphs	60

Chapter 1

Introduction and Background

1.1 Motivation and Structure

The study of the tautological intersection theory of the moduli space of curves was initiated in the seminal [1]. In Mumford's words, this entails

*[...] setting up a Chow ring for the moduli space \mathcal{M}_g of curves of genus g and its compactification $\overline{\mathcal{M}}_g$, defining what seem to be the most important classes in this ring
[...]*

Realizing that the full Chow ring of $\overline{\mathcal{M}}_{g,n}$ was largely out of reach, he sought to identify a set of classes that mediates between the following tension: we seek a theory that on the one hand, has manageable algebraic structure, and on the other hand captures a large number of Chow classes that are geometrically defined. Remarkably, the absolute minimal requirements on algebraic structure, i.e. to be subalgebras which contain fundamental classes and to be closed under push-forwards via the natural gluing and forgetful morphisms, already produce a quite robust theory; many interesting classes such as the Chern classes of the Hodge bundle, Hurwitz classes, Gromov-Witten classes and Brill-Noether classes (including hyperelliptic classes) are tautological ([2]).

In [3], Graber and Pandharipande exhibit a set of additive generators for the tautological ring, parametrized by dual graphs with vertices decorated by monomials in κ -classes and flags decorated by powers of ψ -classes. Following this result, a natural direction of investigation is to describe geometrically defined tautological classes in terms of these standard generators. There are two technical obstructions to this plan: first, the ranks of the graded parts of the tautological rings for positive dimensional classes grow rather fast as g or n get larger; second, there are many relations among the standard generators and generally no canonical or especially meaningful choice for a basis of the tautological ring. For this reason, until recently, the study of the structure of families

of tautological cycles was mostly restricted to top intersections (e.g. Gromov-Witten invariants, Hurwitz numbers); these are cycles of dimension zero, hence proportional to the class of a point.

When positive dimensional tautological classes come in families, it is desirable to describe them in a way that highlights such structure. A graph formula, i.e. a formula that describes a tautological class as a sum over graphs with local (vertex, edge, flag) decorations is a combinatorially pleasing and effective way to achieve this goal. In [4], the authors prove a remarkable graph formula, conjectured by Pixton, for double ramification loci. In [5], Cavalieri and Tarasca give graph formulas for the classes of genus 2 curves with marked Weierstrass points which form a subset of hyperelliptic classes we study later. More recently, in [6] Schmitt and van Zelm compute explicitly some hyperelliptic classes in higher genus. Though a full description of hyperelliptic classes remains illusive, in [7] it is shown that certain such classes are extremal and rigid in the cone of effective classes on $\overline{\mathcal{M}}_{2,n}$. Chapter 2 is dedicated to generalizing this result.

Alongside boundary strata and the special classes mentioned above, two families of classes play a prominent role in the tautological ring: ψ -classes (Definition 1.3.1) and κ -classes (Definition 1.3.4). Geometrically, ψ -classes arise when taking non-transversal intersections of boundary strata. The most remarkable feature of intersection numbers of ψ -classes is Witten's conjecture/Kontsevich's theorem ([8,9]): a generating function \mathcal{F} for intersection numbers of ψ classes (the Gromov-Witten potential) is a τ -function for the KdV hierarchy. One formulation of this statement says there exist a countable number of differential operators L_n ($n \geq -1$) that annihilate $e^{\mathcal{F}}$. The vanishing of the coefficient of each monomial in $e^{\mathcal{F}}$ gives a recursion on the intersection numbers of ψ classes, and such recursions allow computations of all top intersection numbers of ψ classes from the initial condition $\int_{\overline{\mathcal{M}}_{0,3}} 1 = 1$. The culmination of Chapter 3 is the connection of ψ -class intersection theory to κ -class intersection theory and the transformation of Witten's conjecture to the κ -class setting (Theorem 3.4.2).

Mumford's conjecture ([1]), now a theorem by Madsen and Weiss ([10]), brought κ -classes to the foreground: the stable cohomology of \mathcal{M}_g is a polynomial ring freely generated by the κ -classes. More recently, Pandharipande ([11]) studied the restriction of the κ -ring, the part of

the tautological ring of the moduli space of curves generated by κ -classes, to the locus of curves of compact type; he unveiled the following interesting structure: the higher genus κ -rings are quotients of the genus zero ones in a canonical way. A survey on recent developments in the study of the κ -ring appears in [12]. In the latter half of Chapter 3 we utilize our version of Witten's conjecture for κ -classes to establish generating relations in genus 2 and 3 of these rings.

In explicitly connecting the ψ -class and κ -class intersection theories, we also consider ω -classes, sometimes called stable ψ -classes. In addition to being a useful tool to connect the more classical ψ - and κ -classes, ω -classes can be seen as coming from a family of compactifications of $\mathcal{M}_{g,n}$ called Hassett spaces or moduli spaces of weighted curves, first introduced in [13]. Hassett spaces are all birational to each other and to $\overline{\mathcal{M}}_{g,n}$ and arise from the log minimal model program. They come equipped with their own weighted ψ -classes; when pulled back to $\overline{\mathcal{M}}_{g,n}$, the intersection theory of these weighted ψ -classes can be described combinatorially in terms of classical ψ -classes, in analogy to ω -classes. We explore this connection in depth in Chapter 4.

1.2 Moduli of Curves

Given two non-negative integers g, n satisfying $2g - 2 + n > 0$, we denote by $\overline{\mathcal{M}}_{g,n}$ the fine moduli stack of Deligne-Mumford stable curves of genus g with n marked points; we denote points of $\overline{\mathcal{M}}_{g,n}$ by $(C; p_1, \dots, p_n)$ with $p_1, \dots, p_n \in C$ smooth marked points.

The space $\overline{\mathcal{M}}_{g,n}$ is a smooth projective Deligne-Mumford stack of dimension $3g - 3 + n$ and is stratified by locally closed substacks parametrizing topologically equivalent marked curves. These strata are naturally indexed by **dual graphs**, constructed via **gluing morphisms** as follows: given a marked curve $(C; p_1, \dots, p_n)$, consider the normalization $\nu : C' \rightarrow C$ of the curve C ; attach a flag to each point $\nu^{-1}(p_i)$, labeled by the corresponding mark; for each node $x \in C$, connect by an edge the two points in $\nu^{-1}(x)$; then contract each irreducible component of the normalization to a vertex, and label it by the genus of the component.

Let g_1, g_2 be two non-negative integers adding to g , and $\{A, B\}$ a partition¹ of the set $[n]$. The **gluing morphism**

$$gl_{(g_1,A)|(g_2,B)} : \overline{\mathcal{M}}_{g_1,A \cup \{\bullet\}} \times \overline{\mathcal{M}}_{g_2,B \cup \{\star\}} \rightarrow \overline{\mathcal{M}}_{g,n} \quad (1.1)$$

identifies the marks denoted by \star and \bullet to assign to a pair $((C_1; \{p_i\}_{i \in A}, \bullet), (C_2; \{p_j\}_{j \in B}, \star))$ the marked nodal curve $(C_1 \cup_{\bullet=\star} C_2; p_1, \dots, p_n)$. The image of the gluing morphism is an irreducible, closed subvariety of $\overline{\mathcal{M}}_{g,n}$ called a **boundary divisor** and denoted $\Delta_{g_1,A}$.

More generally, given a nodal, pointed, stable curve $(C; p_1, \dots, p_n)$, we can identify its topological type by its dual graph Γ ([14]). We define a more general gluing morphism

$$gl_{\Gamma} : \prod_{v \in V(\Gamma)} \overline{\mathcal{M}}_{g(v), val(v)} \rightarrow \overline{\mathcal{M}}_{g,n} \quad (1.2)$$

to be the morphism that glues marked points corresponding to pairs of flags that form an edge of the dual graph. The morphism gl_{Γ} is finite of degree $|Aut(\Gamma)|$ onto its image. We call the image of gl_{Γ} a **boundary stratum** and denote it by Δ_{Γ} . As a cycle class:

$$[\Delta_{\Gamma}] = \frac{1}{|Aut(\Gamma)|} gl_{\Gamma*}(1). \quad (1.3)$$

The irreducible divisor, which corresponds to the graph with a single vertex of genus $g - 1$ and a single self-edge, is denoted Δ_{irr} . The gluing morphism is in this case denoted

$$gl_{irr} : \overline{\mathcal{M}}_{g-1,n+2} \rightarrow \overline{\mathcal{M}}_{g,n} \quad (1.4)$$

and is two-to-one onto its image. Any boundary stratum not in the irreducible divisor and where all of the genus is concentrated at one vertex of the dual graph is called a stratum of **rational tails** type.

¹If $g_i = 0$, we require $|P_i| \geq 2$

For $i \in [n + 1]$, there exists a **forgetful morphism**

$$\pi_i := \pi_{p_i} : \overline{\mathcal{M}}_{g,n+1} \rightarrow \overline{\mathcal{M}}_{g,[n+1]\setminus\{i\}} \cong \overline{\mathcal{M}}_{g,n} \quad (1.5)$$

which assigns to an $(n + 1)$ -marked curve $(C; p_1, \dots, p_{n+1})$ the n -marked curve obtained by forgetting the i th marked point and contracting any rational component of C which has fewer than three special points (marks or nodes). The morphism π_i functions as a universal family for $\overline{\mathcal{M}}_{g,n}$, which in particular allows the universal curve $\overline{\mathcal{U}}_{g,n} \rightarrow \overline{\mathcal{M}}_{g,n}$ to be identified with $\overline{\mathcal{M}}_{g,n+1}$.

The i -th **tautological section**

$$\sigma_i : \overline{\mathcal{M}}_{g,n} \rightarrow \overline{\mathcal{U}}_{g,n} \cong \overline{\mathcal{M}}_{g,n+1} \quad (1.6)$$

assigns to an n -pointed curve $(C; p_1, \dots, p_n)$ the point p_i in the fiber over $(C; p_1, \dots, p_n)$ in the universal curve. Such a point corresponds to the $(n + 1)$ -pointed curve obtained by attaching a rational component to the point $p_i \in C$ and placing the marks p_i and p_{n+1} arbitrarily on the new rational component. Via the identification of the universal map with a forgetful morphism, the section σ_i may be viewed as a gluing morphism and its image as a boundary stratum, denoted $\Delta_{i,n+1}$. The following diagram illustrates this concept:

$$\begin{array}{ccc} \overline{\mathcal{U}}_{g,n} & \xrightarrow{\cong} & \overline{\mathcal{M}}_{g,n+1} & (1.7) \\ \subseteq & & \subseteq & \\ \text{Im}(\sigma_i) & & \Delta_{i,n+1} & \\ \sigma_i \uparrow & & \uparrow \text{gl}_{((g,[n]\setminus\{i\})\cup\{\bullet\})|(0,\{*,i,n+1\})} & \\ \overline{\mathcal{M}}_{g,n} & \xrightarrow{\cong} & \overline{\mathcal{M}}_{g,[n]\setminus\{i\}\cup\{\bullet\}} \times \overline{\mathcal{M}}_{0,\{*,i,n+1\}} & \end{array}$$

We consider all $\overline{\mathcal{M}}_{g,n}$ (for all values of g, n) as a system of moduli spaces connected by the tautological morphisms and define the **tautological ring** $\mathcal{R} = \{R^*(\overline{\mathcal{M}}_{g,n})\}_{g,n}$ of this system to be the smallest system of subrings of the Chow ring of each $\overline{\mathcal{M}}_{g,n}$ containing all fundamental classes

$[\overline{\mathcal{M}}_{g,n}]$ and closed under push-forwards and pull-backs via the tautological (gluing and forgetful) morphisms. By (1.3), classes of boundary strata are elements of the tautological ring.

1.3 Important Tautological Classes

We now introduce some other families of tautological classes which are studied in this work beyond boundary strata.

Definition 1.3.1. For any choice of mark $i \in [n]$, the class $\psi_i \in R^1(\overline{\mathcal{M}}_{g,n})$ is defined to be:

$$\psi_i := c_1(\sigma_i^*(\omega_\pi)), \quad (1.8)$$

where ω_π denotes the relative dualizing sheaf of the universal family $\pi : \overline{\mathcal{U}}_{g,n} \rightarrow \overline{\mathcal{M}}_{g,n}$.

Remark 1.3.2. In order to streamline notation, when we write ψ -classes (and later ω -classes) relative to some flag of a dual graph, we implicitly mean the push-forward via the appropriate gluing morphism of the pullback via the projection to the factor hosting the flag of the corresponding class. See Figure 1.1 for an illustration.

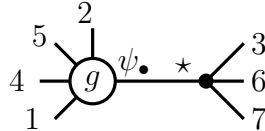

Figure 1.1: The dual graph identifying the divisor $D = D(P|Q)$, with $P = \{1, 2, 4, 5\}$ and $Q = \{3, 6, 7\}$. The graph is decorated with a ψ -class on a flag. This is shorthand for $gl_{D_*} p_1^*(\psi_\bullet)$.

Definition 1.3.3. Let $g, n \geq 1, i \in [n]$, and let $\rho_i : \overline{\mathcal{M}}_{g,n} \rightarrow \overline{\mathcal{M}}_{g,\{i\}}$ be the composition of forgetful morphisms for all but the i -th mark. Then we define

$$\omega_i := \rho_i^* \psi_i \quad (1.9)$$

in $R^1(\overline{\mathcal{M}}_{g,n})$.

Definition 1.3.4. For a non-negative integer i , the class $\kappa_i \in R^i(\overline{\mathcal{M}}_{g,n})$ is:

$$\kappa_i := \pi_{n+1*}(\psi_{n+1}^{i+1}). \quad (1.10)$$

Remark 1.3.5. In [1], Mumford first introduces κ -classes on $\overline{\mathcal{M}}_g$ as

$$\kappa_i := \pi_*(c_1(\omega_\pi)^{i+1}), \quad (1.11)$$

where $\pi : \overline{\mathcal{M}}_{g,1} \cong \overline{\mathcal{U}}_g \rightarrow \overline{\mathcal{M}}_g$ denotes the universal family. One may verify that on $\overline{\mathcal{M}}_{g,1}$

$$\psi_1 = c_1(\omega_\pi), \quad (1.12)$$

which makes the (unique) ψ -class on $\overline{\mathcal{M}}_{g,1}$ a canonically constructed class. There are two different ways to generalize this class to spaces with more than one mark: simply pulling-back the class ψ gives rise to the class ω , whereas interpreting ψ as the Euler class of a line bundle whose fiber over the moduli point $(C; p)$ is $T_p^*(C)$ generalizes to the definition of ψ -class given above.

Let $D_{i,n+1}$ denote the class of the image of the section σ_i , generically parameterizing nodal curves where one component is rational and hosts the i -th and $(n+1)$ -th marks. The following lemma shows how ψ -classes behave when pulled-back via forgetful morphisms.

Lemma 1.3.6 ([15]). *Consider the forgetful morphism $\pi_{n+1} : \overline{\mathcal{M}}_{g,n+1} \rightarrow \overline{\mathcal{M}}_{g,n}$. For $i \in [n]$, we have:*

$$\psi_i = \pi_{n+1}^*(\psi_i) + D_{i,n+1}. \quad (1.13)$$

Iterated applications of Lemma 1.3.6 show the relation between the classes ψ_i and ω_i on $\overline{\mathcal{M}}_{g,n}$.

Lemma 1.3.7. *Let $g, n \geq 1$ and $i \in [n]$. Then:*

$$\psi_i = \omega_i + \sum_{B \ni i} D(A|B) \quad (1.14)$$

In words, this means that ψ_i is obtained from ω_i by adding all divisors of rational tails type where the i -th mark is contained in the rational component.

Analogously to ψ -classes, κ -classes require a correction term when being pulled back via forgetful morphism.

Lemma 1.3.8 ([16]). *Consider the forgetful morphism $\pi_{n+1} : \overline{\mathcal{M}}_{g,n+1} \rightarrow \overline{\mathcal{M}}_{g,n}$. We have:*

$$\kappa_i = \pi_{n+1}^*(\kappa_i) + \psi_{n+1}^i. \quad (1.15)$$

The next group of lemmas gives information about the behavior of tautological classes under push-forward via forgetful morphisms. These are familiar facts for people in the field, but it is non-trivial to track down appropriate references; for this reason we add brief sketches of proofs that could be completed by the interested reader. Pushing-forward a monomial in ψ -classes along a morphism that forgets a mark that does not support a ψ -class one obtains the so-called **string recursion**.

Lemma 1.3.9 (String). *Consider the forgetful morphism $\pi_{n+1} : \overline{\mathcal{M}}_{g,n+1} \rightarrow \overline{\mathcal{M}}_{g,n}$. Let $K \in \mathbb{Z}^n$ denote the vector (k_1, \dots, k_n) and e_i the i -th standard basis vector. By ψ^K we mean $\prod \psi_i^{k_i}$ and we adopt the convention that $\psi_i^m = 0$ whenever $m < 0$. Then:*

$$\pi_{n+1*}(\psi^K) = \sum_{i=1}^n \psi^{K-e_i}. \quad (1.16)$$

Proof. Equation (1.16) is proved by using Lemma 1.3.6 to replace each $\psi_i^{k_i}$ with $\pi_{n+1}^*(\psi_i)^{k_i} + D_{i,n+1}\pi_{n+1}^*(\psi_i)^{k_i-1}$, and then applying projection formula to obtain the right hand side of (1.16). More details can be found in [15, Lemma 1.4.2]. \square

Lemma 1.3.10 (ω -string). *Let $n > 0$, and consider the forgetful morphism $\pi_{n+1} : \overline{\mathcal{M}}_{g,n+1} \rightarrow \overline{\mathcal{M}}_{g,n}$. Let $K \in \mathbb{Z}^n$ denote the vector (k_1, \dots, k_n) and $\omega^K = \prod \omega_i^{k_i}$. Then:*

$$\pi_{n+1*}(\omega^K) = 0. \quad (1.17)$$

Proof. The map π_{n+1} has positive dimensional fibers, and by definition $\omega^K = \pi_{n+1}^*(\omega^K)$, which implies the vanishing of the push-forward. \square

Lemma 1.3.11. *For any g, n with $2g - 2 + n > 0$,*

$$\kappa_0 = (2g - 2 + n)[1]_{\overline{\mathcal{M}}_{g,n}}. \quad (1.18)$$

Proof. The space $\overline{\mathcal{M}}_{g,n}$ is proper, connected, and irreducible, hence the class κ_0 must be a multiple of the fundamental class. Fixing a moduli point $[(C; p_1, \dots, p_n)] \in \overline{\mathcal{M}}_{g,n}$, by projection formula the multiple is computed as $\deg(\omega_C(p_1 + \dots + p_n)) = 2g - 2 + n$. \square

Lemma 1.3.12 (Dilaton). *Consider the forgetful morphism $\pi_{n+1} : \overline{\mathcal{M}}_{g,n+1} \rightarrow \overline{\mathcal{M}}_{g,n}$. Let $K \in \mathbb{Z}^n$ denote a vector of non-negative integers $(k_1, \dots, k_n) \neq (0, \dots, 0)$. Then:*

$$\pi_{n+1*}(\psi^K \psi_{n+1}) = (2g - 2 + n)\psi^K. \quad (1.19)$$

Proof. By Lemma 1.3.6 and the basic vanishing $\psi_{n+1} D_{i,n+1} = 0$, we have

$$\psi^K \psi_{n+1} = \pi_{n+1}^*(\psi^K) \psi_{n+1}.$$

The proof is concluded by applying projection formula and using Lemma 1.3.11. \square

Lemma 1.3.13 (ω -dilaton). *Let $g + n \geq 2$, and consider the forgetful morphism $\pi_{n+1} : \overline{\mathcal{M}}_{g,n+1} \rightarrow \overline{\mathcal{M}}_{g,n}$. Let $K \in \mathbb{Z}^n$ denote a vector of non-negative integers (k_1, \dots, k_n) . Then:*

$$\pi_{n+1*}(\omega^K \omega_{n+1}) = (2g - 2)\omega^K. \quad (1.20)$$

Proof. First assume $g \geq 2$, and consider the following commutative diagram:

$$\begin{array}{ccc}
\overline{\mathcal{M}}_{g,n+1} & \xrightarrow{\pi_{n+1}} & \overline{\mathcal{M}}_{g,n} \\
\rho_{n+1} \downarrow & & \downarrow F \\
\overline{\mathcal{M}}_{g,\{n+1\}} & \xrightarrow{\pi_{n+1}} & \overline{\mathcal{M}}_g.
\end{array} \tag{1.21}$$

We have $\pi_{n+1*}(\omega_{n+1}) = \pi_{n+1*}\rho_{n+1}^*(\psi_{n+1}) = F^*\pi_{n+1*}(\psi_{n+1}) = (2g-2)[1]_{\overline{\mathcal{M}}_{g,n}}$. Equation (1.20) then follows by projection formula.

When $g = 1$, any monomial in ω -classes of degree greater than one vanishes because $\omega_i = \lambda_1$ and $\lambda_1^2 = 0$ ([1, (5.4)]). Similarly, $\pi_{n+1*}(\omega_i) = 0$, since λ_1 is pulled-back from $\overline{\mathcal{M}}_{1,1}$. \square

The proof of Lemma 1.3.13 generalizes to give a natural relation between ω - and κ -classes.

Lemma 1.3.14 ([17, Lemma 3.3]). *Let $g \geq 2$, and consider the total forgetful morphism $F : \overline{\mathcal{M}}_{g,n} \rightarrow \overline{\mathcal{M}}_g$. Let $K \in \mathbb{Z}^n$ denote a vector of non-negative integers (k_1, \dots, k_n) and $\vec{1} = (1, 1, \dots, 1)$. Then:*

$$F_*(\omega^K) = \kappa_{K-\vec{1}}. \tag{1.22}$$

Finally, we use two lemmas about ψ -class intersections in genus zero.

Lemma 1.3.15. *For i, j, k distinct elements of the set of marks, the class $\psi_i \in R^1(\overline{\mathcal{M}}_{0,n})$ may be represented by the following expression:*

$$\psi_i = \sum_{\substack{A \ni j, k \\ B \ni i}} D(A|B). \tag{1.23}$$

Proof. This result follows from iterated applications of (1.13). The base case is $\overline{\mathcal{M}}_{0,\{i,j,k\}} \cong \overline{\mathcal{M}}_{0,3}$, where all ψ -classes are 0 for dimension reasons. \square

We note that such an expression is neither unique nor canonical, as it depends on the choice of the auxiliary marks j, k . However, as a corollary of Lemma 1.3.15 we have a canonical boundary expression for a sum of two ψ -classes.

Lemma 1.3.16. *Let $n \geq 3$; for any distinct $i, j \in [n]$ the following identity holds in the tautological ring of $\overline{\mathcal{M}}_{0,n}$:*

$$\psi_i + \psi_j = \sum_{\substack{A \ni j \\ B \ni i}} D(A|B). \quad (1.24)$$

Proof. Choose a point $k \in [n] - \{i, j\}$ and apply (1.23) to obtain:

$$\psi_i = \sum_{\substack{A \ni j, k \\ B \ni i}} D(A|B), \quad \psi_j = \sum_{\substack{A \ni j \\ B \ni i, k}} D(A|B). \quad (1.25)$$

The lemma follows immediately from adding the two terms in (1.25). □

1.4 Intersection Theory on $\overline{\mathcal{M}}_{g,n}$

The intersection theory of tautological classes on $\overline{\mathcal{M}}_{g,n}$ has a highly combinatorial structure; this structure informs the bulk of this dissertation. This section is intended to be a quick primer; for more detail and relevant proofs we recommend [18].

If $[\Delta_{\Gamma_1}]$ and $[\Delta_{\Gamma_2}]$ are (classes of) boundary strata corresponding respectively to graphs Γ_1 and Γ_2 , their intersection is given as a sum of decorated (classes of) boundary strata with $\Delta_{\Gamma'} \subseteq \Delta_{\Gamma_1}, \Delta_{\Gamma_2}$ and $\text{codim } \Delta_{\Gamma'} \leq \text{codim } \Delta_{\Gamma_1} + \text{codim } \Delta_{\Gamma_2}$. That is, the corresponding dual graphs in the intersection are those for which there exists sequences of edge contractions T_1 and T_2 such that T_1 transforms Γ' to Γ_1 and T_2 transforms Γ' to Γ_2 . We decorate each $[\Delta_{\Gamma'}]$ as follows: for every edge E in Γ' which is contracted under neither T_1 nor T_2 , we multiply by $-\psi_{\bullet_E} - \psi_{\star_E}$ (in the sense of Remark 1.3.2).

We next discuss how ω -classes restrict to boundary strata. When the i -th mark is on a component that remains stable after forgetting all other marks, then one can show, with an identical proof to the case of ψ -classes, that ω_i restricts to the class ω_i pulled back via the projection from

the factor containing the i -th mark. Things are more interesting when the i -th mark is on a rational tail, as we show in the next lemma.

Lemma 1.4.1. *Let $D(A|B)$ be a divisor of rational tails type, and suppose the i -th marked point is on the rational component ($i \in B$). Then, for any non-negative integer k*

$$\omega_i^k \cdot D(A|B) = gl_{D*}(\omega_{\bullet}^k), \quad (1.26)$$

where as usual ω_{\bullet} denotes the class pulled back from the projection $pr : \overline{\mathcal{M}}_{g,AU\{\bullet\}} \times \overline{\mathcal{M}}_{0,BU\{\star\}} \rightarrow \overline{\mathcal{M}}_{g,AU\{\bullet\}}$

Proof. Consider the following diagram:

$$\begin{array}{ccc} \overline{\mathcal{M}}_{g,AU\{\bullet\}} \times \overline{\mathcal{M}}_{0,BU\{\star\}} & & \\ \downarrow gl_D \searrow pr & & \\ \overline{\mathcal{M}}_{g,n} & \xrightarrow{\rho_{AU\{i\}}} & \overline{\mathcal{M}}_{g,AU\{i\}} \xrightarrow{\rho_i} \overline{\mathcal{M}}_{g,\{i\}} \end{array}$$

The map pr is the projection onto $\overline{\mathcal{M}}_{g,AU\{\bullet\}}$ composed with the isomorphism which relabels \bullet to i . Then by the commutativity of the diagram and the definition of ω_i ,

$$\begin{aligned} \omega_i^k \cdot D(A|B) &= gl_{D*} gl_D^*(\omega_i^k) \\ &= gl_{D*} gl_D^* \rho_{AU\{i\}}^* \rho_i^*(\psi_i^k) \\ &= gl_{D*} pr^* \rho_i^*(\psi_i^k) \\ &= gl_{D*}(\omega_{\bullet}^k). \quad \square \end{aligned}$$

Lemma 1.4.2. *Let $g \geq 1$, $n \geq 2$, and $P \subset \{p_1, \dots, p_n\}$ such that $|P| \leq n - 2$. Then for any $p_i, p_j \notin P$, we have $\omega_{p_i} \cdot [\Delta_{g,P}] = \omega_{p_j} \cdot [\Delta_{g,P}]$ on $\overline{\mathcal{M}}_{g,n}$.*

Proof. This follows immediately from Lemma 1.4.1. □

Chapter 2

Hyperelliptic Loci

Our first result involves hyperelliptic loci, using a slight generalization from their usual definition (see for example [7]). We begin the chapter by intruding some background specific to hyperelliptic loci and recalling admissible map spaces. We then discuss effective classes and the properties of rigidity and extremality (Definition 2.1.1). Finally we define hyperelliptic loci (Definition 2.2.1) and prove the chapter's main theorem (Theorem 2.2.4).

2.1 Additional Background

Every smooth curve of genus two admits a unique degree-two **hyperelliptic** map to \mathbb{P}^1 . The Riemann-Hurwitz formula forces such a map to have six ramification points called **Weierstrass points**; each non-Weierstrass point p exists as part of a **conjugate pair** (p, p') such that the images of p and p' agree under the hyperelliptic map.

The locus of curves of genus two with ℓ marked Weierstrass points is codimension ℓ inside the moduli space $\mathcal{M}_{2,\ell}$, and in [7] it is shown that the class of the closure of this locus is rigid and extremal in the cone of effective classes of codimension ℓ . Theorem 2.2.4 extends their result to $\mathcal{H}_{2,\ell,2m,n} \subseteq \mathcal{M}_{2,\ell+2m+n}$, the locus of genus-two curves with ℓ marked Weierstrass points, m marked conjugate pairs, and n free marked points (see Definition 2.2.1).

In [19], the authors show that the effective cone of codimension-two classes of $\overline{\mathcal{M}}_{2,n}$ has infinitely many extremal cycles for every n . Here we pursue a perpendicular conclusion: although in genus two the number of marked Weierstrass points can be at most six, the number of conjugate pairs and free marked points are unbounded, so that the classes $[\overline{\mathcal{H}}_{2,\ell,2m,n}]$ form an infinite family of rigid and extremal cycles in arbitrarily-high codimension. Moreover, the induction technique used to prove the main result is genus-agnostic, pointing towards a natural extension of the main theorem to higher genus given a small handful of low-codimension cases.

When $\ell + m \geq 3$, our induction argument (Theorem 2.2.4) is a generalization of that used in [7, Theorem 4] to include conjugate pairs and free points; it relies on pushing forward an effective decomposition of one hyperelliptic class onto other hyperelliptic classes and showing that the only term of the decomposition to survive all pushforwards is the original class itself. This process is straightforward when there are at least three codimension-one conditions available to forget; however, when $\ell + m = 2$, and in particular when $\ell = 2$ and $m = 0$, more care must be taken. The technique used in [7, Theorem 5] to overcome this problematic subcase relies on an explicit expression for $[\overline{\mathcal{H}}_{2,2,0,0}]$ which becomes cumbersome when a non-zero number of free marked points are allowed. Although adding free marked points can be described via pullback, pullback does not preserve rigidity and extremality in general, so we introduce an intersection-theoretic calculation using ω -classes (Lemma 1.4.2) to handle this case instead.

The base case of the induction (Theorem 2.2.2) is shown via a criterion (Lemma 2.1.2) given by [20] for rigidity and extremality for divisors; it amounts to an additional pair of intersection calculations. We utilize the theory of moduli spaces of admissible covers to construct a suitable curve class for the latter intersection, a technique which generalizes that used in [21] for the class of $\overline{\mathcal{H}}_{2,1,0,0}$.

Hyperelliptic curves are those which admit a degree-two map to \mathbb{P}^1 . The Riemann-Hurwitz formula implies that a hyperelliptic curve of genus g contains $2g + 2$ Weierstrass points which ramify over the branch locus in \mathbb{P}^1 . For a fixed genus, specifying the branch locus allows one to recover the complex structure of the hyperelliptic curve and hence the hyperelliptic map. Thus for $g \geq 2$, the codimension of the locus of hyperelliptic curves in $\overline{\mathcal{M}}_{g,n}$ is $g - 2$. In this context, requiring that a marked point be Weierstrass (resp. two marked points be a conjugate pair) is a codimension-one condition for genus at least two.

We briefly use the theory of **moduli spaces of admissible covers** to construct a curve in $\overline{\mathcal{M}}_{2,n}$ in Theorem 2.2.2. These spaces are particularly nice compactifications of Hurwitz schemes. For a thorough introduction, the standard references are [22] and [23]. For a more hands-on approach in the same vein as our usage, see as well [24].

Restrict now to the case of $g = 2$. We use $W_{2,P}$ to denote the codimension-two class of the stratum whose general element agrees with that of $[\Delta_{2,P}]$, with the additional requirement that the node be a Weierstrass point. We denote by $\gamma_{1,P}$ the class of the closure of the locus of curves whose general element has a genus 1 component containing the marked points P meeting in two points conjugate under a hyperelliptic map a rational component with marked points $\{p_1, \dots, p_n\} \setminus P$ (see Figure 2.1).

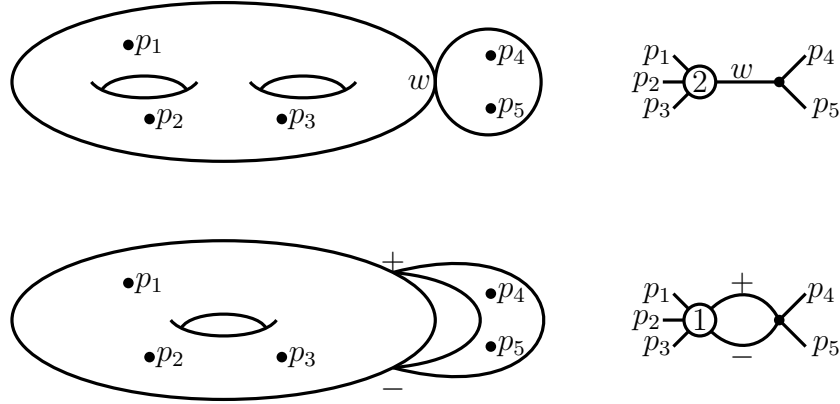

Figure 2.1: On the left-hand side, the topological pictures of the general elements of $W_{2,P}$ (top) and $\gamma_{1,P}$ (bottom) in $\overline{\mathcal{M}}_{2,5}$ with $P = \{p_1, p_2, p_3\}$. On the right-hand side, the corresponding dual graphs.

The space $\overline{Adm}_{2 \rightarrow 0, t_1, \dots, t_6, u_{1\pm}, \dots, u_{n\pm}}$ is the moduli space of degree-two admissible covers of genus two with marked ramification points (Weierstrass points) t_i and marked pairs of points (conjugate pairs) u_{j+} and u_{j-} . This space comes with a finite map c to $\overline{\mathcal{M}}_{0, \{t_1, \dots, t_6, u_1, \dots, u_n\}}$ which forgets the cover and remembers only the base curve and its marked points, which are the images of the markings on the source. It comes also with a degree 2^n map s to $\overline{\mathcal{M}}_{2, 1+n}$ which forgets the base curve and all u_{j+} and t_i other than t_1 and remembers the (stabilization of the) cover.

For a projective variety X , the sum of two effective codimension- d classes is again effective, as is any \mathbb{Q}_+ -multiple of the same. This gives a natural convex cone structure on the set of effective classes of codimension d inside the \mathbb{Q} vector space of all codimension- d classes, called the **effective cone of codimension- d classes** and denoted $\text{Eff}^d(X)$. Given an effective class E in the Chow ring of X , an **effective decomposition of E** is an equality

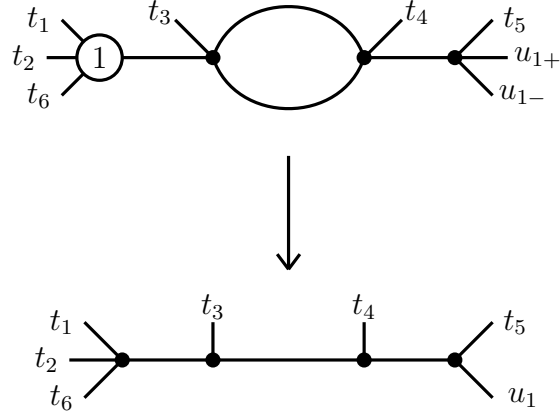

Figure 2.2: An admissible cover in $\overline{Adm}_{2 \rightarrow 0, t_1, \dots, t_6, u_{1\pm}}$ represented via dual graphs. In degree two the topological type of the cover is uniquely recoverable from the dual graph presentation.

$$E = \sum_{s=1}^m a_s E_s$$

with $a_s > 0$ and E_s irreducible effective cycles on X for all s . The main properties we are interested in for classes in the pseudo-effective cone are rigidity and extremality.

Definition 2.1.1. Let $E \in \text{Eff}^d(X)$.

E is **rigid** if any effective cycle with class rE is supported on the support of E .

E is **extremal** if, for any effective decomposition of E , all E_s are proportional to E .

When $d = 1$, elements of the cone correspond to divisor classes, and the study of $\text{Eff}^1(\overline{\mathcal{M}}_{g,n})$ is fundamental in the theory of the birational geometry of these moduli spaces. For example, $\overline{\mathcal{M}}_{0,n}$ is known to fail to be a Mori dream space for $n \geq 10$ (first for $n \geq 134$ in [25], then for $n \geq 13$ in [26], and the most recent bound in [27]). For $n \geq 3$ in genus one, [20] show that $\overline{\mathcal{M}}_{1,n}$ is not a Mori dream space; the same statement is true for $\overline{\mathcal{M}}_{2,n}$ by [28]. In these and select other cases, the pseudo-effective cone of divisors has been shown to have infinitely many extremal cycles and thus is not rational polyhedral ([19]).

These results are possible due in large part to the following lemma, which plays an important role in Theorem 2.2.2. Here a **moving curve \mathcal{C} in D** is a curve \mathcal{C} , the deformations of which cover a Zariski-dense subset of D .

Lemma 2.1.2 ([20, Lemma 4.1]). *Let D be an irreducible effective divisor in a projective variety X , and suppose that C is a moving curve in D satisfying $\int_X [D] \cdot [C] < 0$. Then $[D]$ is rigid and extremal.*

Remark 2.1.3. Using Lemma 2.1.2 to show a divisor D is rigid and extremal in fact shows more: if the lemma is satisfied, the boundary of the pseudo-effective cone is polygonal at D . We do not rely on this fact, but see [29, §6] for further discussion.

Lemma 2.1.2 allows us to change a question about the pseudo-effective cone into one of intersection theory and provides a powerful tool in the study of divisor classes. Unfortunately, it fails to generalize to higher-codimension classes, where entirely different techniques are needed. Consequently, much less is known about $\text{Eff}^d(\overline{\mathcal{M}}_{g,n})$ for $d \geq 2$. In [19], the authors develop additional extremality criteria to show that in codimension-two there are infinitely many extremal cycles in $\overline{\mathcal{M}}_{1,n}$ for all $n \geq 5$ and in $\overline{\mathcal{M}}_{2,n}$ for all $n \geq 2$, as well as showing that two additional hyperelliptic classes of higher genus are extremal. These criteria cannot be used directly for the hyperelliptic classes we consider; this is illustrative of the difficulty of proving rigidity and extremality results for classes of codimension greater than one.

2.2 Definition and Theorem

The proof of Theorem 2.2.4 proceeds via induction, with the base cases given in Theorem 2.2.2. We begin by defining hyperelliptic classes on $\overline{\mathcal{M}}_{g,n}$.

Definition 2.2.1. Fix integers $\ell, m, n \geq 0$. Denote by $\overline{\mathcal{H}}_{g,\ell,2m,n}$ the closure of the locus of hyperelliptic curves in $\overline{\mathcal{M}}_{g,\ell+2m+n}$ with marked Weierstrass points w_1, \dots, w_ℓ ; pairs of marked points $+_1, -_1, \dots, +_m, -_m$ with $+_j$ and $-_j$ conjugate under the hyperelliptic map; and *free* marked points p_1, \dots, p_n with no additional constraints. By *hyperelliptic class*, we mean a non-empty class equivalent to some $[\overline{\mathcal{H}}_{g,\ell,2m,n}]$ in the Chow ring of $\overline{\mathcal{M}}_{g,\ell+2m+n}$.

Lemma 2.1.2 allows us to establish the rigidity and extremality of the two divisor hyperelliptic classes for genus two, which together provide the base case for Theorem 2.2.4.

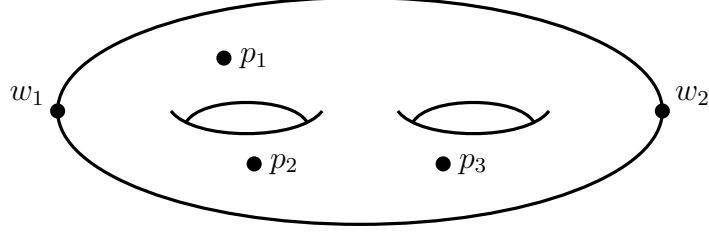

Figure 2.3: The general element of $\overline{\mathcal{H}}_{2,2,0,3}$.

Theorem 2.2.2. *For $n \geq 0$, the class of $\overline{\mathcal{H}}_{2,0,2,n}$ is rigid and extremal in $\text{Eff}^1(\overline{\mathcal{M}}_{2,2+n})$ and the class of $\overline{\mathcal{H}}_{2,1,0,n}$ is rigid and extremal in $\text{Eff}^1(\overline{\mathcal{M}}_{2,1+n})$.*

Proof. Define a moving curve \mathcal{C} in $\overline{\mathcal{H}}_{2,0,2,n}$ by fixing a general genus-two curve C with n free marked points p_1, \dots, p_n and varying the conjugate pair $(+, -)$.

Since $[\overline{\mathcal{H}}_{2,0,2,n}] = \pi_{p_n}^* \cdots \pi_{p_1}^* [\overline{\mathcal{H}}_{2,0,2,0}]$, by the projection formula and the identity (see [30])

$$[\overline{\mathcal{H}}_{2,0,2,0}] = -\lambda + \psi_+ + \psi_- - 3[\Delta_{2,\emptyset}] - [\Delta_{1,\emptyset}],$$

we compute

$$\begin{aligned} \int_{\overline{\mathcal{M}}_{2,2+n}} [\overline{\mathcal{H}}_{2,0,2,n}] \cdot [\mathcal{C}] &= \int_{\overline{\mathcal{M}}_{2,2}} [\overline{\mathcal{H}}_{2,0,2,0}] \cdot \pi_{p_1^*} \cdots \pi_{p_n^*} [\mathcal{C}] \\ &= 0 + (4 - 2 + 6) + (4 - 2 + 6) - 3(6) - 0 \\ &= -2. \end{aligned}$$

In particular, intersecting with λ is 0 by projection formula. Intersecting with either ψ -class can be seen as follows: pullback ψ_i from $\overline{\mathcal{M}}_{2,1}$ to $\psi_i - [\Delta_{2,\emptyset}]$, then use projection formula on ψ_i back to $\overline{\mathcal{M}}_{2,1}$. This is just $2g - 2$, since ψ_i is the first Chern class of the cotangent bundle of C over i . The intersection with $[\Delta_{2,\emptyset}]$ corresponds to the $2g + 2$ Weierstrass points. Finally, $[\Delta_{1,\emptyset}]$ intersects trivially, since by fixing C we have only allowed rational tail degenerations. As $[\overline{\mathcal{H}}_{2,0,2,n}]$ is irreducible, it is rigid and extremal by Lemma 2.1.2.

We next apply Lemma 2.1.2 by constructing a moving curve \mathcal{B} which intersects negatively with $\overline{\mathcal{H}}_{2,1,0,n}$ using the following diagram. Note that the image of s is precisely $\overline{\mathcal{H}}_{2,1,0,n} \subset \overline{\mathcal{M}}_{2,1+n}$.

$$\begin{array}{ccc}
\overline{Adm}_{2 \rightarrow 0, t_1, \dots, t_6, u_{1\pm}, \dots, u_{n\pm}} & \xrightarrow{s} & \overline{\mathcal{M}}_{2,1+n} \\
\downarrow c & & \\
\overline{\mathcal{M}}_{0, \{t_1, \dots, t_6, u_1, \dots, u_n\}} & & \\
\downarrow \pi_{t_6} & & \\
\overline{\mathcal{M}}_{0, \{t_1, \dots, t_5, u_1, \dots, u_n\}} & &
\end{array}$$

Fix the point $[b_n]$ in $\overline{\mathcal{M}}_{0, \{t_1, \dots, t_5, u_1, \dots, u_n\}}$ corresponding to a chain of \mathbb{P}^1 's with $n + 3$ components and marked points as shown in Figure 2.4 (if $n = 0$, t_4 and t_5 are on the final component; if $n = 1$, t_5 and u_1 are on the final component; etc.). Then $[\mathcal{B}_n] = s_* c^* \pi_{t_6}^* [b_n]$ is a moving curve in $\overline{\mathcal{H}}_{2,1,0,n}$ (after relabeling t_1 to w_1 and u_{j-} to p_j).

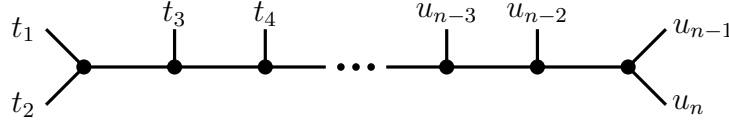

Figure 2.4: The point $[b_n]$ in $\overline{\mathcal{M}}_{0, \{t_1, \dots, t_5, u_1, \dots, u_n\}}$.

The intersection $[\overline{\mathcal{H}}_{2,1,0,n}] \cdot [\mathcal{B}_n]$ is not transverse, so we correct with minus the Euler class of the normal bundle of $\overline{\mathcal{H}}_{2,1,0,n}$ in $\overline{\mathcal{M}}_{2,1+n}$ restricted to \mathcal{B}_n . In other words,

$$\begin{aligned}
\int_{\overline{\mathcal{M}}_{2,1+n}} [\overline{\mathcal{H}}_{2,1,0,n}] \cdot [\mathcal{B}_n] &= \int_{\overline{\mathcal{M}}_{2,1+n}} -\pi_{p_n}^* \cdots \pi_{p_1}^* \psi_{w_1} \cdot [\mathcal{B}_n] \\
&= \int_{\overline{\mathcal{M}}_{2,1}} -\psi_{w_1} \cdot [\mathcal{B}_0].
\end{aligned}$$

By passing to the space of admissible covers and using the fact that $[\overline{\mathcal{H}}_{1,2,0,0}] = 3\psi_{w_1}$ ([31]), this integral is seen to be a positive multiple (a power of two) of

$$\int_{\overline{\mathcal{M}}_{1,2}} -\psi_{w_1} \cdot [\overline{\mathcal{H}}_{1,2,0,0}] = \int_{\overline{\mathcal{M}}_{1,2}} -\psi_{w_1} \cdot (3\psi_{w_1}) = -\frac{1}{8}. \quad \square$$

This establishes the base case for the inductive hypothesis in Theorem 2.2.4. The induction procedure differs fundamentally for the codimension-two classes, so we first prove the following short lemma to simplify the most complicated of those.

Lemma 2.2.3. *The class $W_{2,\{p_1,\dots,p_n\}}$ is not proportional to $[\overline{\mathcal{H}}_{2,2,0,n}]$ on $\overline{\mathcal{M}}_{2,2+n}$.*

Proof. Let $P = \{p_1, \dots, p_n\}$. Note that in $W_{2,P}$ the marked points w_1 and w_2 carry no special restrictions, and the class is of codimension two. By dimensionality on the rational component of the general element of $W_{2,P}$,

$$W_{2,P} \cdot \psi_{w_1}^{n+3} = 0.$$

However, using the equality

$$[\overline{\mathcal{H}}_{2,2,0,0}] = 6\psi_{w_1}\psi_{w_2} - \frac{3}{2}(\psi_{w_1}^2 + \psi_{w_2}^2) - (\psi_{w_1} + \psi_{w_2}) \left(\frac{21}{10}[\Delta_{1,\{w_1\}}] + \frac{3}{5}[\Delta_{1,\emptyset}] + \frac{1}{20}[\Delta_{irr}] \right)$$

established in [7, Equation 4] and Faber's Maple program [32], we compute

$$\begin{aligned} \int_{\overline{\mathcal{M}}_{2,2+n}} [\overline{\mathcal{H}}_{2,2,0,n}] \cdot \psi_{w_1}^{n+3} &= \int_{\overline{\mathcal{M}}_{2,2+n}} \pi_{p_1}^* \cdots \pi_{p_n}^* [\overline{\mathcal{H}}_{2,2,0,0}] \cdot \psi_{w_1}^{n+3} \\ &= \int_{\overline{\mathcal{M}}_{2,2}} [\overline{\mathcal{H}}_{2,2,0,0}] \cdot \pi_{p_1*} \cdots \pi_{p_n*} \psi_{w_1}^{n+3} \\ &= \int_{\overline{\mathcal{M}}_{2,2}} \left(6\psi_{w_1}\psi_{w_2} - \frac{3}{2}(\psi_{w_1}^2 + \psi_{w_2}^2) \right. \\ &\quad \left. - (\psi_{w_1} + \psi_{w_2}) \left(\frac{21}{10}[\Delta_{1,\{w_1\}}] + \frac{3}{5}[\Delta_{1,\emptyset}] + \frac{1}{20}[\Delta_{irr}] \right) \right) \cdot \psi_{w_1}^3 \\ &= \frac{1}{384}, \end{aligned}$$

so $W_{2,P}$ is not a non-zero multiple of $[\overline{\mathcal{H}}_{2,2,0,n}]$. □

We are now ready to prove our main result. The bulk of the effort is in establishing extremality, though the induction process does require rigidity at every step as well. Although we do not include

it until the end, the reader is free to interpret the rigidity argument as being applied at each step of the induction.

The overall strategy of the extremality portion of the proof is as follows. Suppose $[\overline{\mathcal{H}}_{2,\ell,2m,n}]$ is given an effective decomposition. We show (first for the classes of codimension at least three, then for those of codimension two) that any terms of this decomposition which survive pushforward by π_{w_i} or π_{+j} must be proportional to the hyperelliptic class itself. Therefore we may write $[\overline{\mathcal{H}}_{2,\ell,2m,n}]$ as an effective decomposition using only classes which vanish under pushforward by the forgetful morphisms; this is a contradiction, since the hyperelliptic class itself survives pushforward.

Theorem 2.2.4. *For $\ell, m, n \geq 0$, the class $\overline{\mathcal{H}}_{2,\ell,2m,n}$, if non-empty, is rigid and extremal in $\text{Eff}^{\ell+m}(\overline{\mathcal{M}}_{2,\ell+2m+n})$.*

Proof. We induct on codimension; assume the claim holds when the class is codimension $\ell+m-1$. Theorem 2.2.2 is the base case, so we may further assume $\ell+m \geq 2$. Now, suppose that

$$[\overline{\mathcal{H}}_{2,\ell,2m,n}] = \sum_s a_s [X_s] + \sum_t b_t [Y_t] \quad (2.1)$$

is an effective decomposition with $[X_s]$ and $[Y_t]$ irreducible codimension- $(\ell+m)$ effective cycles on $\overline{\mathcal{M}}_{2,\ell+2m+n}$, with $[X_s]$ surviving pushforward by some π_{w_i} or π_{+j} and $[Y_t]$ vanishing under all such pushforwards, for each s and t .

Fix an $[X_s]$ appearing in the right-hand side of (2.1). If $\ell \neq 0$, suppose without loss of generality (on the w_i) that $\pi_{w_1*} [X_s] \neq 0$. Since

$$\pi_{w_1*} [\overline{\mathcal{H}}_{2,\ell,2m,n}] = (6 - (\ell - 1)) [\overline{\mathcal{H}}_{2,\ell-1,2m,n}]$$

is rigid and extremal by hypothesis, $\pi_{w_1*} [X_s]$ is a positive multiple of the class of $\overline{\mathcal{H}}_{2,\ell-1,2m,n}$ and $X_s \subseteq (\pi_{w_1})^{-1} \overline{\mathcal{H}}_{2,\ell-1,2m,n}$. By the commutativity of the following diagrams and the observation that hyperelliptic classes survive pushforward by all π_{w_i} and π_{+j} , we have that $\pi_{w_i*} [X_s] \neq 0$ and $\pi_{+j*} [X_s] \neq 0$ for all i and j .

$$\begin{array}{ccc}
\overline{\mathcal{H}}_{2,\ell,2m,n} & \xrightarrow{\pi_{+j}} & \overline{\mathcal{H}}_{2,\ell,2(m-1),n+1} \\
\downarrow \pi_{w_1} & & \downarrow \pi_{w_1} \\
\overline{\mathcal{H}}_{2,\ell-1,2m,n} & \xrightarrow{\pi_{+j}} & \overline{\mathcal{H}}_{2,\ell-1,2(m-1),n+1}
\end{array}
\qquad
\begin{array}{ccc}
\overline{\mathcal{H}}_{2,\ell,2m,n} & \xrightarrow{\pi_{w_i}} & \overline{\mathcal{H}}_{2,\ell-1,2m,n} \\
\downarrow \pi_{w_1} & & \downarrow \pi_{w_1} \\
\overline{\mathcal{H}}_{2,\ell-1,2m,n} & \xrightarrow{\pi_{w_i}} & \overline{\mathcal{H}}_{2,\ell-2,2m,n}
\end{array}$$

If $\ell = 0$, suppose without loss of generality (on the $+_j$) that $\pi_{+1*}[X_s] \neq 0$. Then the same conclusion holds that $[X_s]$ survives all pushforwards by π_{+j} , since

$$\pi_{+1*}[\overline{\mathcal{H}}_{2,\ell,2m,n}] = [\overline{\mathcal{H}}_{2,\ell,2(m-1),n+1}]$$

is rigid and extremal by hypothesis, and π_{+1} commutes with π_{+j} .

It follows that for any $\ell + m \geq 2$

$$X_s \subseteq \bigcap_{i,j} ((\pi_{w_i})^{-1}\overline{\mathcal{H}}_{2,\ell-1,2m,n} \cap (\pi_{+j})^{-1}\overline{\mathcal{H}}_{2,\ell,2(m-1),n+1}).$$

We now have two cases. If $\ell + m \geq 3$, any $\ell + 2m - 1$ Weierstrass or conjugate pair marked points in a general element of X_s are distinct, and hence all $\ell + 2m$ such marked points in a general element of X_s are distinct. We conclude that $[X_s]$ is a positive multiple of $[\overline{\mathcal{H}}_{2,\ell,2m,n}]$. If $\ell + m = 2$, we must analyze three subcases.

If $\ell = 0$ and $m = 2$, then

$$X_s \subseteq (\pi_{+1})^{-1}\overline{\mathcal{H}}_{2,0,2,n+1} \cap (\pi_{+2})^{-1}\overline{\mathcal{H}}_{2,0,2,n+1}.$$

The modular interpretation of the intersection leaves three candidates for $[X_s]$: $W_{2,P}$ or $\gamma_{1,P}$ for some P containing neither conjugate pair, or $[\overline{\mathcal{H}}_{2,0,4,n}]$ itself. However, for the former two, $\dim W_{2,P} \neq \dim \pi_{+1}(W_{2,P})$ and $\dim \gamma_{1,P} \neq \dim \pi_{+1}(\gamma_{1,P})$ for all such P , contradicting our assumption that the class survived pushforward. Thus $[X_s]$ is proportional to $[\overline{\mathcal{H}}_{2,0,4,n}]$.

If $\ell = 1$ and $m = 1$, similar to the previous case, $[X_s]$ could be $[\overline{\mathcal{H}}_{2,1,2,n}]$ or $W_{2,P}$ or $\gamma_{1,P}$ for some P containing neither the conjugate pair nor the Weierstrass point. However, if X_s is either

of the latter cases, we have $\dim X_s \neq \dim \pi_{+1}(X_s)$, again contradicting our assumption about the non-vanishing of the pushforward, and so again $[X_s]$ must be proportional to $[\overline{\mathcal{H}}_{2,1,2,n}]$.

If $\ell = 2$ and $m = 0$, as before, $[X_s]$ is either $[\overline{\mathcal{H}}_{2,2,0,n}]$ itself or $W_{2,P}$ or $\gamma_{1,P}$ for $P = \{p_1, \dots, p_n\}$. Now $\dim W_{2,P} = \dim \pi_{w_i} W_{2,P}$, so the argument given in the other subcases fails (though $\gamma_{1,P}$ is still ruled out as before). Nevertheless, we claim that $W_{2,P}$ cannot appear on the right-hand side of (2.1) for $\overline{\mathcal{H}}_{2,2,0,n}$; to show this we induct on the number of free marked points n . The base case of $n = 0$ is established in [7, Theorem 5], so assume that $\overline{\mathcal{H}}_{2,2,0,n-1}$ is rigid and extremal for some $n \geq 1$. Suppose for the sake of contradiction that

$$[\overline{\mathcal{H}}_{2,2,0,n}] = a_0 W_{2,P} + \sum_s a_s [Z_s] \quad (2.2)$$

is an effective decomposition with each $[Z_s]$ an irreducible codimension-two effective cycle on $\overline{\mathcal{M}}_{2,2+n}$. Note that

$$W_{2,P} = \pi_{p_n}^* W_{2,P \setminus \{p_n\}} - W_{2,P \setminus \{p_n\}}.$$

Multiply (2.2) by ω_{p_n} (Definition 1.3.3) and push forward by π_{p_n} . On the left-hand side,

$$\begin{aligned} \pi_{p_n*} (\omega_{p_n} \cdot [\overline{\mathcal{H}}_{2,2,0,n}]) &= \pi_{p_n*} (\omega_{p_n} \cdot \pi_{p_n}^* [\overline{\mathcal{H}}_{2,2,0,n-1}]) \\ &= \pi_{p_n*} (\omega_{p_n}) \cdot [\overline{\mathcal{H}}_{2,2,0,n-1}] \\ &= 2 [\overline{\mathcal{H}}_{2,2,0,n-1}], \end{aligned}$$

having applied Lemma 1.3.13. Combining this with the right-hand side,

$$\begin{aligned} 2 [\overline{\mathcal{H}}_{2,2,0,n-1}] &= a_0 \pi_{p_n*} (\omega_{p_n} \cdot \pi_{p_n}^* W_{2,P \setminus \{p_n\}} - \omega_{p_n} \cdot W_{2,P \setminus \{p_n\}}) + \sum_s a_s \pi_{p_n*} (\omega_{p_n} \cdot [Z_s]) \\ &= 2a_0 W_{2,P \setminus \{p_n\}} + \pi_{p_n*} (\omega_{p_n} \cdot W_{2,P \setminus \{p_n\}}) + \sum_s a_s \pi_{p_n*} (\omega_{p_n} \cdot [Z_s]). \end{aligned}$$

The term $\pi_{p_n^*}(\omega_{p_n} \cdot W_{2,P \setminus \{p_n\}})$ vanishes by Lemma 1.4.2:

$$\begin{aligned}
\pi_{p_n^*}(\omega_{p_n} \cdot W_{2,P \setminus \{p_{n-1}\}}) &= \pi_{p_n^*}(\omega_{w_1} \cdot W_{2,P \setminus \{p_n\}}) \\
&= \pi_{p_n^*}(\pi_{p_n^*}^* \omega_{w_1} \cdot W_{2,P \setminus \{p_n\}}) \\
&= \omega_{w_1} \cdot \pi_{p_n^*} W_{2,P \setminus \{p_n\}} \\
&= 0,
\end{aligned}$$

where w_1 is the Weierstrass singular point on the genus two component of $W_{2,P \setminus \{p_n\}}$. Altogether, we have

$$2 [\overline{\mathcal{H}}_{2,2,0,n-1}] = 2a_0 W_{2,P \setminus \{p_n\}} + \sum_s a_s \pi_{p_n^*}(\omega_{p_n} \cdot [Z_s]).$$

In [21] it is established that ψ_{p_n} is semi-ample on $\overline{\mathcal{M}}_{2,\{p_n\}}$, so ω_{p_n} is semi-ample, and hence this is an effective decomposition. By hypothesis, $\overline{\mathcal{H}}_{2,2,0,n-1}$ is rigid and extremal, so $W_{2,P \setminus \{p_n\}}$ must be a non-zero multiple of $[\overline{\mathcal{H}}_{2,2,0,n-1}]$, which contradicts Lemma 2.2.3. Therefore $W_{2,P}$ cannot appear as an $[X_s]$ in (2.1).

Thus for all cases of $\ell + m = 2$ (and hence for all $\ell + m \geq 2$), we conclude that each $[X_s]$ in (2.1) is a positive multiple of $[\overline{\mathcal{H}}_{2,\ell,2m,n}]$. Now subtract these $[X_s]$ from (2.1) and rescale, so that

$$[\overline{\mathcal{H}}_{2,\ell,2m,n}] = \sum_t b_t [Y_t].$$

Recall that each $[Y_t]$ is required to vanish under all $\pi_{w_i^*}$ and π_{+j^*} . But the pushforward of $[\overline{\mathcal{H}}_{2,\ell,2m,n}]$ by any of these morphisms is non-zero, so there are no $[Y_t]$ in (2.1). Hence $[\overline{\mathcal{H}}_{2,\ell,2m,n}]$ is extremal in $\text{Eff}^{\ell+m}(\overline{\mathcal{M}}_{2,\ell+2m+n})$.

For rigidity, suppose that $E := r [\overline{\mathcal{H}}_{2,\ell,2m,n}]$ is effective. Since

$$\pi_{w_i^*} E = (6 - (\ell - 1))r [\overline{\mathcal{H}}_{2,\ell-1,2m,n}]$$

and

$$\pi_{+j*}E = r \left[\overline{\mathcal{H}}_{2,\ell,2(m-1),n+1} \right]$$

are rigid and extremal for all i and j , we have that $\pi_{w_i*}E$ is supported on $\overline{\mathcal{H}}_{2,\ell-1,2m,n}$ and $\pi_{+j*}E$ is supported on $\overline{\mathcal{H}}_{2,\ell,2(m-1),n+1}$. This implies that E is supported on

$$\bigcup_i (\pi_{w_i})^{-1} \left[\overline{\mathcal{H}}_{2,\ell-1,2m,n} \right] \cup \bigcup_j (\pi_{+j})^{-1} \left[\overline{\mathcal{H}}_{2,\ell,2(m-1),n+1} \right].$$

Thus E is supported on $\overline{\mathcal{H}}_{2,\ell,2m,n}$, so $\left[\overline{\mathcal{H}}_{2,\ell,2m,n} \right]$ is rigid. \square

2.3 Higher Genus Results

The general form of the inductive argument in Theorem 2.2.4 holds independent of genus for $g \geq 2$. However, for genus greater than one, the locus of hyperelliptic curves in \mathcal{M}_g is of codimension $g - 2$, so that the base cases increase in codimension as g increases. The challenge in showing the veracity of the claim for hyperelliptic classes in arbitrary genus is therefore wrapped up in establishing the base cases of codimension $g - 1$ (corresponding to Theorem 2.2.2) and codimension g (corresponding to the three $\ell + m = 2$ subcases in Theorem 2.2.4).

In particular, our proof of Theorem 2.2.2 relies on the fact that $\overline{\mathcal{H}}_{2,0,2,n}$ and $\overline{\mathcal{H}}_{2,1,0,n}$ are divisors, and the subcase $\ell = 2$ in Theorem 2.2.4 depends on our ability to prove Lemma 2.2.3. This in turn requires the description of $\overline{\mathcal{H}}_{2,2,0,0}$ given by [7]. More subtly, we require that ψ_{p_n} be semi-ample in $\overline{\mathcal{M}}_{2,\{p_n\}}$, which is shown in [33] to be false in genus greater than two in characteristic zero. In genus three, [19] show that the base case $\overline{\mathcal{H}}_{3,1,0,0}$ is rigid and extremal, though it is unclear if their method will extend to $\overline{\mathcal{H}}_{3,1,0,n}$. Moreover, little work has been done to establish the case of a single conjugate pair in genus three, and as the cycles move farther from divisor classes, such analysis becomes increasingly more difficult.

One potential avenue to overcome these difficulties is suggested by work of Cavalieri and Tarasca in [5]. They use an inductive process to describe hyperelliptic classes in terms of dec-

orated graphs using the usual dual graph description of the tautological ring of $\overline{\mathcal{M}}_{g,n}$. Such a formula for the three necessary base cases would allow for greatly simplified intersection-theoretic calculations, similar to those used in Theorem 2.2.2 and Lemma 2.2.3. Though such a result would be insufficient to completely generalize our main theorem, it would be a promising start.

We also believe the observation that pushing forward and pulling back by forgetful morphisms moves hyperelliptic classes to (multiples of) hyperelliptic classes is a useful one. There is evidence that a more explicit connection between marked Weierstrass points, marked conjugate pairs, and the usual gluing morphisms between moduli spaces of marked curves exists as well, though concrete statements require a better understanding of higher genus hyperelliptic loci. Although it is known that hyperelliptic classes do not form a cohomological field theory over the full $\overline{\mathcal{M}}_{g,n}$, a deeper study of the relationship between these classes and the natural morphisms among the moduli spaces may indicate a CohFT-like structure, which in turn would shed light on graph formulas or other additional properties.

Chapter 3

ω -classes and κ -classes

In this chapter we discuss the intersection theory of ω - and κ -classes. The general strategy is to first connect ω -classes to ψ -classes, and then apply Lemma 1.3.14 to transfer the theory to the κ -class situation (Section 3.1, Section 3.2, and Section 3.3). One of the highlights of the chapter is the explicit statement of Witten's conjecture for κ -classes (Theorem 3.4.2), with appropriately-transformed Virasoro operators (Definition 3.4.1). This leads to a recursive algorithm to compute relations in the κ -class-valued subring of $R^*(\overline{\mathcal{M}}_g)$, which we present explicitly for genus less than four (Section 3.5).

3.1 Cycle and Numerical Theorems

In this section we state and prove the graph formula for the class of an arbitrary monomial in ω -classes. We begin by introducing the family of boundary strata which appear in the formula. Throughout this section, we fix two positive integers g and n for genus and number of marked points.

We denote by $\mathcal{P} \vdash [n]$ a partition of the set $[n]$, i.e. a collection of pairwise disjoint subsets P_1, \dots, P_r called **parts** such that

$$P_1 \cup \dots \cup P_r = [n].$$

We wish to consider partitions as unordered; in other words, we identify two partitions if they differ by a permutation of the parts. We assume all the P_i s are non-empty and say \mathcal{P} has length r (and write $\ell(\mathcal{P}) = r$). We assign to this data a stratum in $\overline{\mathcal{M}}_{g,n}$ of codimension equal to the number of parts of \mathcal{P} of size greater than one as follows.

Definition 3.1.1. Given $\mathcal{P} \vdash [n]$, when $|P_i| = 1$ denote by \bullet_i the element of the singleton P_i . For $|P_i| > 1$, introduce new labels \bullet_i and \star_i . The **pinwheel stratum** $\Delta_{\mathcal{P}}$ is the image of the gluing morphism

$$gl_{\mathcal{P}} : \overline{\mathcal{M}}_{g, \{\bullet_1, \dots, \bullet_r\}} \times \prod_{|P_i| > 1} \overline{\mathcal{M}}_{0, \{\star_i\} \cup P_i} \rightarrow \overline{\mathcal{M}}_{g, n}$$

that glues together each \bullet_i with \star_i . The class of the stratum equals the push-forward of the fundamental class via $gl_{\mathcal{P}}$.

$$[\Delta_{\mathcal{P}}] = gl_{\mathcal{P}*}([1]). \quad (3.1)$$

Figure 3.1 shows an example of the dual graph of a generic element of a pinwheel stratum.

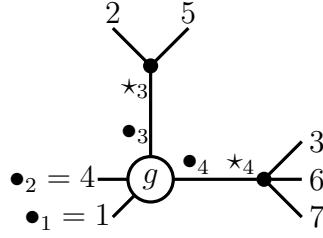

Figure 3.1: The dual graph to the generic curve parameterized by the pinwheel stratum $\Delta_{\mathcal{P}}$, with $\mathcal{P} = \{1\}, \{4\}, \{2, 5\}, \{3, 6, 7\}$. The flags of the graph are decorated with the auxiliary markings coming from the gluing morphism.

Theorem 3.1.2. For $1 \leq i \leq n$, let k_i be a non-negative integer, and let $K = \sum_{i=1}^n k_i$. For any partition $\mathcal{P} = \{P_1, \dots, P_r\} \vdash [n]$, define $\alpha_j := \sum_{i \in P_j} k_i$. With notation as in the previous paragraph, the following formula holds in $R^K(\overline{\mathcal{M}}_{g, n})$:

$$\prod_{i=1}^n \omega_i^{k_i} = \sum_{\mathcal{P} \vdash [n]} [\Delta_{\mathcal{P}}] \prod_{j=1}^{\ell(\mathcal{P})} \frac{\psi_{\bullet_j}^{\alpha_j}}{(-\psi_{\bullet_j} - \psi_{\star_j})^{1-\delta_j}}, \quad (3.2)$$

where $\delta_j = \delta_{1, |P_j|}$ is a Kronecker delta and we follow the standard convention of considering negative powers of ψ equal to 0.

Proof. The proof mirrors Theorem 4.2.4 in Chapter 4 and can be seen as a corollary by allowing the weights $a_i \rightarrow \epsilon \ll 1$. We leave the proof for that more general setting. \square

Remark 3.1.3. In formula (3.2), the denominator of the rational function is intended to be expanded as a geometric series in ψ_\star/ψ_\bullet . If $|P_j| > 1$, we have

$$\frac{\psi_\bullet^{\alpha_j}}{(-\psi_\bullet - \psi_\star)} = -\psi_\bullet^{\alpha_j-1} + \psi_\bullet^{\alpha_j-2}\psi_\star - \psi_\bullet^{\alpha_j-3}\psi_\star^2 + \dots \quad (3.3)$$

The convention that negative powers of ψ vanish implies that the sum in (3.3) is finite. We also observe that if $\alpha_j = 0$, the right-hand side of (3.3) equals 0. Hence the formula is supported on pinwheel strata where each rational tail has at least one point i with strictly positive k_i .

Here is a small example of the statement.

Example 3.1.4. On $\overline{\mathcal{M}}_{g,3}$, we have:

$$\omega_1^3\omega_2^2 = \psi_1^3\psi_2^2 - \psi_\bullet^4[\Delta_{\{1,2\},\{3\}}] - \psi_\bullet^2\psi_2^2[\Delta_{\{1,3\},\{2\}}] - \psi_1^3\psi_\bullet[\Delta_{\{1\},\{2,3\}}] - (\psi_\bullet^4 - \psi_\bullet^3\psi_\star)[\Delta_{\{1,2,3\}}] \quad (3.4)$$

The dual graphs to the strata are illustrated in Figure 3.2.

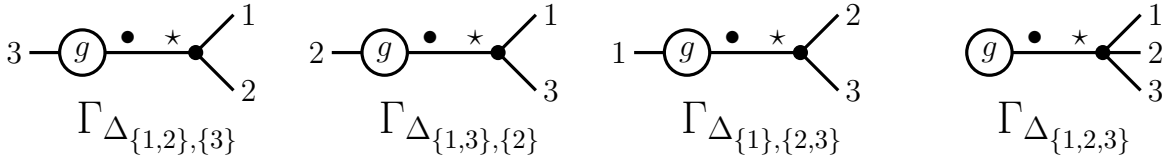

Figure 3.2: The dual graphs for the strata in Example 3.1.4.

For top intersections of ω -classes, we have the following simple consequence of Theorem 3.1.2.

Theorem 3.1.5. For $1 \leq i \leq n$, let k_i be a non-negative integer, and let $\sum_{i=1}^n k_i = 3g - 3 + n$. For any partition $\mathcal{P} = \{P_1, \dots, P_r\} \vdash [n]$, define $\alpha_j := \sum_{i \in P_j} k_i$.

$$\int_{\overline{\mathcal{M}}_{g,n}} \prod_{i=1}^n \omega_i^{k_i} = \sum_{\mathcal{P} \vdash [n]} (-1)^{n+\ell(\mathcal{P})} \int_{\overline{\mathcal{M}}_{g,\ell(\mathcal{P})}} \prod_{i=1}^{\ell(\mathcal{P})} \psi_\bullet^{\alpha_i - |P_i| + 1} \quad (3.5)$$

Proof. This statement follows from formula (3.2), by noticing the following two facts:

- For any partition \mathcal{P} , by dimension reasons the only monomial that has nonzero evaluation on $[\Delta_{\mathcal{P}}]$ is

$$\prod_{|P_i|=1} \psi_{\bullet_i}^{\alpha_i} \prod_{|P_i|>1} (-1)^{|P_i|-1} \psi_{\bullet_i}^{\alpha_i-|P_i|+1} \psi_{\star_i}^{|P_i|-2} \quad (3.6)$$

- For any $n \geq 3$, $i \in [n]$,

$$\int_{\overline{\mathcal{M}}_{0,n}} \psi_i^{n-3} = 1,$$

hence all evaluations for the classes ψ_{\star_i} in (3.6) contribute a factor of one to the evaluation of the monomial on $[\Delta_{\mathcal{P}}]$.

It follows that, for every \mathcal{P} ,

$$\int_{[\Delta_{\mathcal{P}}]} \prod_{|P_i|=1} \psi_{\bullet_i}^{\alpha_i} \prod_{|P_i|>1} (-1)^{|P_i|-1} \psi_{\bullet_i}^{\alpha_i-|P_i|+1} \psi_{\star_i}^{|P_i|-2} = (-1)^{n+\ell(\mathcal{P})} \int_{\overline{\mathcal{M}}_{g,\ell(\mathcal{P})}} \prod_{i=1}^{\ell(\mathcal{P})} \psi_{\bullet_i}^{\alpha_i-|P_i|+1}. \quad \square$$

Combining the results of Theorem 3.1.5 and Lemma 1.3.14, one immediately obtains the following combinatorial formula relating κ - and ψ -class top intersections.

Corollary 3.1.6. *Let $g \geq 2$, and for $1 \leq i \leq n$ let l_i be a non-negative integer, with $\sum_{i=1}^n l_i = 3g - 3$. For any partition $\mathcal{P} = \{P_1, \dots, P_r\} \vdash [n]$, define $\beta_j := \sum_{i \in P_j} l_i$. Then:*

$$\int_{\overline{\mathcal{M}}_g} \prod_{i=1}^n \kappa_{l_i} = \sum_{\mathcal{P} \vdash [n]} (-1)^{n+\ell(\mathcal{P})} \int_{\overline{\mathcal{M}}_{g,\ell(\mathcal{P})}} \prod_{j=1}^{\ell(\mathcal{P})} \psi_{\bullet_j}^{\beta_j+1}. \quad (3.7)$$

The authors of [16] credit Carel Faber for formulas expressing the pushforward of a monomial in ψ -classes as a polynomial in κ -classes. It is there remarked, and formally proven in [11, Lemma 7.2], that Faber's formulas give an invertible linear transformation between ψ - and κ -class intersection numbers. The formula in Corollary 3.1.6 provides an explicit inverse of this linear transformation. Note also that Corollary 3.1.6 agrees with Corollary 7.10 in [34], where the authors study numerical intersections of ψ -classes on Hassett spaces of weighted stable maps.

3.2 Generating Functions and Differential Operators

In this section we introduce generating functions for intersection numbers of ψ -, ω -, and κ -classes, and we show that Corollary 3.1.5 gives rise to functional equations relating these potentials. We first introduce the generating function for intersection numbers of ψ -classes, also known as the Gromov-Witten potential of a point or just the Witten potential. The Witten potential encodes intersection products for the classical ψ -classes on $\overline{\mathcal{M}}_{g,n}$; it is this potential which features famously in Witten's Conjecture/Kontsevich's Theorem [8,9].

Denote $\vec{\tau} := \sum_0^\infty t_i \tau_i$, where the t_i are coordinates on a countably dimensional vector space \mathbb{H}^+ with basis given by the vectors τ_i . The Witten brackets, depending on g, n , define multilinear functions on \mathbb{H}^+ :

$$\langle \tau_0^{n_0} \cdots \tau_m^{n_m} \rangle_{g,n} = \int_{\overline{\mathcal{M}}_{g,n}} \prod_{i=n_0+1}^{n_0+n_1} \psi_i \prod_{i=n_0+n_1+1}^{n_0+n_1+n_2} \psi_i^2 \cdots \prod_{i=n_0+n_1+\dots+n_{m-1}+1}^n \psi_i^{n_m}, \quad (3.8)$$

where $n = \sum_{j=0}^m n_j$ and $3g - 3 + n = \sum_{j=0}^m j n_j$.

Definition 3.2.1. The genus g **Gromov-Witten potential of a point** is defined to be

$$\mathcal{F}^g(t_0, t_1, \dots) = \langle e^{\vec{\tau}} \rangle_g = \sum_{n=0}^{\infty} \frac{1}{n!} \langle \vec{\tau}, \dots, \vec{\tau} \rangle_{g,n}.$$

The **total Gromov-Witten potential** is obtained by summing over all genera and adding a formal variable λ keeping track of genus (more explicitly: of Euler characteristic):

$$\mathcal{F}(\lambda; t_0, t_1, \dots) = \sum_{g=0}^{\infty} \lambda^{2g-2} \mathcal{F}^g(t_0, t_1, \dots).$$

Remark 3.2.2. The Gromov-Witten potential is an exponential generating function for intersection numbers of ψ -classes. Because such intersection numbers are invariant under the action of the symmetric group permuting the marks, the variable t_i does not refer to the insertion at the i -

th mark, but rather to an insertion (at some mark) of ψ^i . For example, the intersection number $\int_{\overline{\mathcal{M}}_{2,6}} \psi_1^6 \psi_2 \psi_3 \psi_4$ is the coefficient of the monomial $\lambda^2 \frac{t_0^2}{2!} \frac{t_1^3}{3!} t_6$ in \mathcal{F} .

We define similar generating functions for ω -classes. Denote $\vec{\sigma} := \sum_0^\infty s_i \sigma_i$, and

$$\langle \sigma_0^{n_0} \cdots \sigma_m^{n_m} \rangle_{g,n} = \int_{\overline{\mathcal{M}}_{g,n}} \prod_{i=n_0+1}^{n_0+n_1} \omega_i \prod_{i=n_0+n_1+1}^{n_0+n_1+n_2} \omega_i^2 \cdots \prod_{i=n_0+n_1+\dots+n_{m-1}+1}^n \omega_i^m. \quad (3.9)$$

Definition 3.2.3. The **genus g ω -potential of a point** is defined to be

$$\mathcal{S}^g(s_0, s_1, \dots) = \langle e^{\vec{\sigma}} \rangle_g = \sum_{n=0}^{\infty} \frac{1}{n!} \langle \vec{\sigma}, \dots, \vec{\sigma} \rangle_{g,n}$$

The **total ω -potential** is:

$$\mathcal{S}(\lambda; s_0, s_1, \dots) = \sum_{g=1}^{\infty} \lambda^{2g-2} \mathcal{S}^g(s_0, s_1, \dots).$$

The analysis of push-forwards of ω -classes yields some immediate results about the structure of \mathcal{S} .

Lemma 3.2.4.

$$\mathcal{S}^g = e^{(2g-2)s_1} \tilde{\mathcal{S}}^g(s_2, s_3, \dots), \quad (3.10)$$

where $\tilde{\mathcal{S}}^g$ is some function depending only on variables s_i , with $i \geq 2$.

Proof. Lemma 1.3.10 implies that \mathcal{S} is constant in s_0 ; the statement of Lemma 1.3.13 is equivalent to showing that \mathcal{S}^g satisfies the differential equation

$$\frac{\partial \mathcal{S}^g}{\partial s_1} = (2g-2) \mathcal{S}^g, \quad (3.11)$$

and therefore it depends exponentially on s_1 . □

Finally, we introduce a potential for intersection numbers of κ -classes on $\overline{\mathcal{M}}_g$.

Definition 3.2.5. Let p_0, p_1, \dots be a countable set of formal variables, and $\mu = (\mu_0, \dots, \mu_i, \dots)$ denote a vector of integers such that $w(\mu) := \sum i\mu_i = 3g - 3$. Then the κ -**potential** is:

$$\mathcal{K}(\lambda; p_0, p_1, \dots) = \frac{p_0}{24} + \sum_{\substack{g \geq 2 \\ w(\mu) = 3g - 3}} \left(\int_{\overline{\mathcal{M}}_g} \prod \kappa_i^{\mu_i} \right) \lambda^{2g-2} \prod \frac{p_i^{\mu_i}}{\mu_i!}.$$

The potentials \mathcal{K} and \mathcal{S} are very closely related.

Lemma 3.2.6.

$$\mathcal{K}(\lambda; p_0, p_1, \dots) = \mathcal{S}(\lambda; 0, p_0, p_1, \dots) = \mathcal{S}(\lambda e^{p_0}; 0, 0, p_1, \dots). \quad (3.12)$$

Proof. Lemma 1.3.14 implies that \mathcal{K} is obtained from \mathcal{S} by setting $\lambda = 1$ and shifting variables so that $s_{i+1} = p_i$. Then the structure statement of Lemma 3.2.4 implies the second equality in (3.12). \square

The equalities (3.12) motivate the introduction of the ‘‘unstable’’ term $p_0/24$, which corresponds to assigning value $1/24$ to κ_0 on $\overline{\mathcal{M}}_1$ (which is not a Deligne-Mumford stack).

The combinatorial formulas of Corollary 3.1.5 can be rephrased as the existence of a differential operator which acts on the Gromov-Witten potential to produce the ω -potential.

Theorem 3.2.7. *Define the fork operator as:*

$$\mathcal{L} := \sum_{n=1}^{\infty} \frac{(-1)^{n-1}}{n!} \sum_{i_1, \dots, i_n=0}^{\infty} s_{i_1} \cdots s_{i_n} \partial_{t_{i_1+\dots+i_n+1-n}}. \quad (3.13)$$

Denote by $\tilde{\mathcal{F}} = \sum_{g=1}^{\infty} \lambda^{2g-2} \mathcal{F}_g$ the positive genus part of the Gromov-Witten potential. Then:

$$(e^{\mathcal{L}} \tilde{\mathcal{F}})|_{t=0} = \mathcal{S} \quad (3.14)$$

Proof. A formal proof of Theorem 3.2.7 is an exercise in bookkeeping: for any given monomial, we show that the coefficients on either side of (3.14) agree, by using formula (3.5).

Fix a monomial $\lambda^{2g-2} \frac{s_1^{k_1}}{k_1!} \cdots \frac{s_n^{k_n}}{k_n!}$; we let $K = 1^{k_1}, 2^{k_2}, \dots, m^{k_m}$ denote a multi-index where the first k_1 indices have value 1, and so on. We do not care about the order of the values, so all multi-indices arising in this proof can be assumed normalized so that the values are non-decreasing. The coefficient for this monomial on the right hand side of (3.14) is $\int_{\overline{\mathcal{M}}_{g,n}} \omega^K$, where we use multi-index notation in the natural way. Formula (3.5) gives an expression for this quantity in terms of a weighted sum over all partitions of the index set, so let us fix a partition $\mathcal{P} = P_1, \dots, P_r$ of the index set. Each part P_i of the partition \mathcal{P} produces a multi-index by looking at the powers of ω -classes supported on the points that belong to P_i . It is possible that different parts give rise to the same multi-index. We denote $\underline{J} = J_1^{v_1}, \dots, J_t^{v_t}$ the collection of the multi-indices arising from the parts of \mathcal{P} , intending that the multi-index J_1 arises v_1 times, and so on. For i from 1 to t , we denote $J_i = 1^{j_{i,1}}, \dots, m^{j_{i,m}}$. Finally, from \underline{J} , we can produce a multi-index $\alpha = \alpha_1^{v_1}, \dots, \alpha_t^{v_t}$, where $\alpha_i = 1 + j_{i,2} + 2j_{i,3} + \dots + (m-1)j_{i,m}$ (this is one plus the sum of the values minus the number of the parts of J_i , as in the definition of the exponents of the ψ -classes in (3.5)). The multi-index α is the exponent vector of the monomial in ψ -classes corresponding to the partition \mathcal{P} in (3.5). It is possible that different partitions of the set of indices give rise to the same multi-index α : in fact there are exactly $\prod k_i! / ((\prod j_{i,l}!)^{v_i} \prod v_i!)$ distinct partitions of the indices that will produce α . We can rewrite (3.5) as a summation over the combinatorial data given by \underline{J} :

$$\int_{\overline{\mathcal{M}}_{g,n}} \omega^K = \sum_{\underline{J}} (-1)^{n+\ell(\alpha)} \frac{\prod k_i!}{(\prod j_{i,l}!)^{v_i} \prod v_i!} \int_{\overline{\mathcal{M}}_{g,\ell(\alpha)}} \psi^\alpha \quad (3.15)$$

We exhibit a summand m_α in $\tilde{\mathcal{F}}$, and a term $L_{\underline{J}}$ in the differential operator $e^{\mathcal{L}}$ such that $L_{\underline{J}} m_\alpha$ is a multiple of $\lambda^{2g-2} \frac{s^K}{K!}$; such multiple may be shown to be $\prod k_i! / ((\prod j_{i,l}!)^{v_i} \prod v_i!)$. Define:

$$m_\alpha = \left(\int_{\overline{\mathcal{M}}_{g,\ell(\alpha)}} \psi^\alpha \right) \lambda^{2g-2} \frac{t_{\alpha_1}^{v_1}}{v_1!} \cdots \frac{t_{\alpha_t}^{v_t}}{v_t!} \quad (3.16)$$

$$L_{\underline{J}} = \frac{(-1)^{n+\ell(\alpha)}}{\prod v_i!} \prod \left(\frac{s_1^{j_{i,1}}}{j_{i,1}!} \cdots \frac{s_m^{j_{i,m}}}{j_{i,m}!} \partial_{t_{\alpha_i}} \right)^{v_i} \quad (3.17)$$

One may show that all pairs of terms $m \in \tilde{\mathcal{F}}$, $L \in e^{\mathcal{L}}$ such that Lm is a multiple of $\lambda^{2g-2} \frac{s^K}{K!}$ arise in this fashion. It follows that the coefficient of $\lambda^{2g-2} \frac{s^K}{K!}$ in $e^{\mathcal{L}} \tilde{\mathcal{F}}$ equals the right hand side of (3.15), and therefore it agrees with the coefficient of the same monomial in \mathcal{S} . This concludes the proof of Theorem 3.2.7. \square

3.3 Change of Variables

Theorem 3.2.7 states that \mathcal{S} is the restriction of a function obtained by applying the exponential² of a vector field to the function $\tilde{\mathcal{F}}$. It follows that the two generating functions are related by a change of variables. In this section, we derive explicitly this change of variables and then deduce an equivalent statement for the potential \mathcal{K} .

Lemma 3.3.1. *With notation as above, and denoting $\mathcal{L} = \sum_{i=0}^{\infty} f_i(\mathbf{s}) \partial_{t_i}$,*

$$e^{\mathcal{L}} \mathcal{F}(\lambda; \mathbf{t}) = \mathcal{F}(\lambda; \mathbf{t} + \mathbf{f}(\mathbf{s})). \quad (3.18)$$

Proof. This is the exponential flow in differential geometry. \square

Corollary 3.3.2. *The potential \mathcal{S} is obtained from $\tilde{\mathcal{F}}$ via the change of variables encoded in the following generating function:*

$$\sum_{i=0}^{\infty} t_i z^i = \left[z \left(1 - \exp \left(\sum_{k=0}^{\infty} -s_k z^{k-1} \right) \right) \right]_+, \quad (3.19)$$

where the subscript $+$ denotes the truncation of the expression in parenthesis to terms with non-negative exponents for the variable z .

Proof. Using Theorem 3.2.7 and Lemma 3.3.1, we obtain that $\mathcal{S}(\lambda; \mathbf{s}) = \tilde{\mathcal{F}}(\lambda; f_0(\mathbf{s}), f_1(\mathbf{s}), \dots)$, where f_i is the coefficient of ∂_{t_i} in the vector field \mathcal{L} . Resumming the coefficients to express \mathcal{L} in

²It is important to note that the coefficients of the vector field are functions in variables that commute with the ∂_{t_i} .

the form $\sum_{i=0} f_i(\mathbf{s}) \partial_{t_i}$ one obtains:

$$\begin{aligned}
t_0 = f_0(\mathbf{s}) &= s_0 - s_0 s_1 + \frac{s_0^2}{2!} s_2 + s_0 \frac{s_1^2}{2!} - \frac{s_0^3}{3!} s_3 - \frac{s_0^2}{2!} s_1 s_2 - s_0 \frac{s_1^3}{3!} + \dots \\
t_1 = f_1(\mathbf{s}) &= s_1 - s_0 s_2 - \frac{s_1^2}{2!} + \frac{s_0^2}{2!} s_3 + s_0 s_1 s_2 + \frac{s_1^3}{3!} - \frac{s_0^3}{3!} s_4 - \dots \\
t_2 = f_2(\mathbf{s}) &= s_2 - s_0 s_3 - s_1 s_2 + \frac{s_0^2}{2!} s_4 + s_0 s_1 s_3 + s_0 \frac{s_2^2}{2!} + \frac{s_1^2}{2!} s_2 - \dots \\
t_3 = f_3(\mathbf{s}) &= s_3 - s_0 s_4 - s_1 s_3 - \frac{s_2^2}{2!} + \frac{s_0^2}{2!} s_5 + s_0 s_1 s_4 + s_0 s_2 s_3 + \frac{s_1^2}{2!} s_3 + s_1 \frac{s_2^2}{2!} - \dots
\end{aligned}$$

It is a simple combinatorial exercise to see that the above change of variables is organized in generating function form as in (3.19). \square

We have at this point all the technical information necessary to give our proof of [35, Thm 4.1].

Before doing so, we establish one final piece of notation.

Definition 3.3.3. For $i \geq 0$ and a countable set of variables $\mathbf{p} = p_1, p_2, \dots$, we define the functions $S_i(\mathbf{p})$ via:

$$\sum_{i=0}^{\infty} S_i(\mathbf{p}) z^i = \exp \left(\sum_{k=1}^{\infty} p_k z^k \right). \quad (3.20)$$

Remark 3.3.4. The functions S_i appear in some literature (especially in the school of integrable systems) as *elementary Schur polynomials*. The reason is that by interpreting the variables p_k as (normalized) power sums,

$$p_k = \frac{\sum x_j^k}{j},$$

then S_i is the *complete symmetric polynomial of degree k* in the variables x_j , which also is the Schur polynomial associated to the one part partition k .

Theorem 3.3.5. *The generating functions $\mathcal{K}(p_0; \mathbf{p})$ and $\tilde{\mathcal{F}}(\lambda; t_0, t_1, \dots)$ agree when restricting the domain of $\tilde{\mathcal{F}}$ to the subspace $t_0 = t_1 = 0$ and applying the following transformation to the remaining variables:*

$$\begin{aligned}
\lambda &= e^{p_0}, \\
t_i &= -S_{i-1}(-\mathbf{p}).
\end{aligned}$$

Proof. By the ω -string relation (Lemma 1.3.10), the function \mathcal{S} is constant in s_0 , therefore, one may restrict the domain to the hyperplane $s_0 = 0$. Imposing this restriction on the transformation given in (3.19), one deduces that the domain of the function $\tilde{\mathcal{F}}$ is restricted to the hyperplane $t_0 = 0$. After reindexing, one obtains:

$$\sum_{i=0}^{\infty} t_{i+1} z^i = 1 - \exp\left(\sum_{k=0}^{\infty} -s_{k+1} z^k\right). \quad (3.21)$$

For $k \geq 0$, define $s_{k+1} = p_k$, to obtain the change of variables:

$$\begin{aligned} t_1 &= 1 - e^{-p_0} \\ t_i &= -e^{-p_0} S_{i-1}(-p_1, -p_2, \dots), \text{ for } i \geq 2. \end{aligned} \quad (3.22)$$

Combining the statement of Corollary 3.19 with Lemma 3.2.6, one obtains

$$\begin{aligned} \mathcal{K}(1; p_0, p_1, \dots) &= \mathcal{S}(1; 0, p_0, p_1, \dots) = \mathcal{S}(e^{p_0}; 0, 0, p_1, \dots) \\ &= \tilde{\mathcal{F}}(1; 0, 1 - e^{-p_0}, -e^{-p_0} S_1(-p_1, -p_2, \dots), -e^{-p_0} S_2(-p_1, -p_2, \dots), \dots) \\ &= \tilde{\mathcal{F}}(e^{p_0}; 0, 0, S_1(-p_1, -p_2, \dots), S_2(-p_1, -p_2, \dots), \dots). \quad \square \end{aligned}$$

3.4 Virasoro Relations for the κ -Potential

The goal of this section is to obtain a countable number of differential equations that annihilate the potential \mathcal{K} , and determine recursively all intersection numbers of κ -classes on $\overline{\mathcal{M}}_g$ from the unstable term $\frac{1}{24}p_0$. We start the section by stating the main result.

Definition 3.4.1. For $n = 0, 1$, \hat{L}_n denotes the differential operator:

$$\hat{L}_0 = -\frac{3}{2}\partial_{p_0} + \sum_{m=0}^{\infty} m p_m \partial_{p_m} + \frac{1}{16},$$

$$\begin{aligned} \hat{L}_1 = & -\frac{15}{4}\partial_{p_1} + \sum_{m=0}^{\infty} m(m+4)p_m\partial_{p_{m+1}} - \sum_{l,m=0}^{\infty} lmp_l p_m\partial_{p_{m+l+1}} \\ & + \frac{(\lambda e^{p_0})^2}{8} \left(\sum_{m=0}^{\infty} (S_{m+2}(\mathbf{p}) - S_{m+2}(2\mathbf{p}))\partial_{p_m} + \sum_{l,m=0}^{\infty} S_{l+1}(\mathbf{p})S_{m+1}(\mathbf{p})\partial_{p_l}\partial_{p_m} \right); \end{aligned}$$

for all $n \geq 2$,

$$\begin{aligned} \hat{L}_n = & \sum_{d=0}^{n+1} \alpha_{n,d} \left(- \sum_{m=0}^{\infty} [B_d(q_1, \dots, q_d)]_{z^m} \partial_{p_{m+n}} \right) \\ & + \frac{(\lambda e^{p_0})^2}{2} \left[\left(\sum_{i=0}^{n-1} \frac{(2i+1)!!(2n-2i-1)!!}{2^{n+1}} \right) \left(\sum_{m=0}^{\infty} S_m(2\mathbf{p})\partial_{p_{m+n-3}} \right) \right. \\ & \left. + \sum_{i=0}^{n-1} \frac{(2i+1)!!(2n-2i-1)!!}{2^{n+1}} \sum_{m,l=0}^{\infty} S_m(\mathbf{p})S_l(\mathbf{p})\partial_{p_{m+n-2-i}}\partial_{p_{l+i-1}} \right], \quad (3.23) \end{aligned}$$

where $\mathbf{p} = (p_1, p_2, p_3, \dots)$ denotes a countable list of variables, S_i is the i -th elementary Schur polynomial (Definition 3.3.3), B_d denotes the d -th Bell polynomial (Definition 3.4.5); the symbols $q_i = -\sum_k k^i p_k z^k$ and $\alpha_{n,d} = [\prod_{i=0}^n (x+i+\frac{3}{2})]_{x^d}$.

Let $\mathcal{K}(p_0, \mathbf{p})$ denote a generating function for top intersection numbers of κ -classes (Definition 3.2.5).

Theorem 3.4.2. *For all $n \geq 0$, we have*

$$\hat{L}_n(e^{\mathcal{K}}) = 0.$$

The vanishing of the coefficients of monomials in $\hat{L}_n(e^{\mathcal{K}})$ gives recursive relations among intersection numbers of κ -classes; the collection of all such recursions uniquely determines \mathcal{K} from the initial condition $\partial_{p_0}\mathcal{K}|_{(p_0, \mathbf{p})=(0,0)} = 1/24$.

The rest of this section is devoted to proving this theorem. To derive these equations, we start from the Virasoro constraints annihilating and determining the Gromov-Witten potential \mathcal{F} .

Theorem 3.4.3 (Witten's conjecture, Kontsevich's theorem). *Consider the differential operators L_n defined as follows:*

$$L_{-1} = -\partial_{t_0} + \sum_{i=0}^{\infty} t_{i+1} \partial_{t_i} + \frac{t_0^2}{2}, \quad (3.24)$$

$$L_0 = -\frac{3}{2} \partial_{t_1} + \sum_{i=0}^{\infty} \frac{(2i+1)}{2} t_i \partial_{t_i} + \frac{1}{16}, \quad (3.25)$$

and for all positive n ,

$$\begin{aligned} L_n = & - \left(\frac{(2n+3)!!}{2^{n+1}} \right) \partial_{t_{n+1}} + \sum_{i=0}^{\infty} \left(\frac{(2i+2n+1)!!}{(2i-1)!! 2^{n+1}} \right) t_i \partial_{t_{i+n}} + \\ & \frac{\lambda^2}{2} \sum_{i=0}^{n-1} \left(\frac{(2i+1)!! (2n-2i-1)!!}{2^{n+1}} \right) \partial_{t_i} \partial_{t_{n-1-i}}. \end{aligned} \quad (3.26)$$

For all $n \geq -1$, we have

$$L_n(e^{\mathcal{F}}) = 0. \quad (3.27)$$

Further, the equations (3.27) determine recursions among the coefficients of \mathcal{F} that uniquely recover the Gromov-Witten potential from the initial condition $\mathcal{F} = \frac{t_0^3}{3!} + \text{higher order terms}$.

Equation (3.24) is equivalent to the string recursion (Lemma 1.3.9), equation (3.25) to dilaton (Lemma 1.3.12). For positive values of n , there is not a geometric interpretation for the recursions on the coefficients of \mathcal{F} given by (3.26).

Theorem 3.3.5 gives an explicit change of variables that equates the potential \mathcal{K} with the restriction of $\tilde{\mathcal{F}}$ to the linear subspace $t_0 = 0, \lambda = 1$. Essentially, since \mathcal{F} is annihilated by the operators L_n , we produce operators annihilating \mathcal{K} by rewriting the L_n in the variables p_i . There are a couple subtle points to address:

1. The function $\mathcal{F} = \tilde{\mathcal{F}} + \frac{\mathcal{F}_0}{\lambda^2}$, where \mathcal{F}_0 is a multiple of t_0^3 . Therefore:

$$\left(L_n e^{\tilde{\mathcal{F}}} \right)_{|t_0=0} = \left(L_n e^{\mathcal{F}} \right)_{|t_0=0},$$

since for any n , L_n has at most a quadratic term in ∂_{t_0} .

2. The operations of applying the differential operator L_n and restricting to the hyperplane $t_0 = 0$ do not commute. In Section 3.4, we use the string equation L_{-1} to replace the operator ∂_{t_0} with a differential operator in the remaining variables.

The computation is long and technical; we break it down into several subsections to give the reader the chance to isolate segments of it that may be of interest.

Auxiliary variables and notation

In this section we make some elementary changes of variables and introduce some notation, in order to simplify the computation. Let:

$$\hat{t}_0 = -(t_1 - 1), \quad \hat{t}_i = -t_{i+1} \text{ for } i = -1 \text{ and } i \geq 1, \quad \hat{p}_k = -p_k \text{ for all } k \geq 0. \quad (3.28)$$

The translation of the variable t_1 by 1 is the well-known **dilaton shift** in Gromov-Witten theory, which has the effect of making the operators L_n homogeneous quadratic. The remaining reindexing and signs are chosen to simplify the change of variables (3.22) to:

$$\sum_{i=0}^{\infty} \hat{t}_i z^i = \exp \left(\sum_{k=0}^{\infty} \hat{p}_k z^k \right), \quad (3.29)$$

or equivalently

$$\hat{t}_i = e^{\hat{p}_0} S_i(\hat{p}_1, \hat{p}_2, \dots). \quad (3.30)$$

In the hatted variables, the operators L_n become:

$$L_{-1} = \sum_{i=-1}^{\infty} \hat{t}_{i+1} \partial_{\hat{t}_i} + \frac{\hat{t}_{-1}^2}{2}, \quad (3.31)$$

$$L_0 = \sum_{i=-1}^{\infty} \frac{(2i+3)}{2} \hat{t}_i \partial_{\hat{t}_i} + \frac{1}{16}, \quad (3.32)$$

$$L_n = \sum_{i=-1}^{\infty} \left(\frac{(2i+2n+3)!!}{(2i+1)!! 2^{n+1}} \right) \hat{t}_i \partial_{\hat{t}_{i+n}} +$$

$$\frac{\lambda^2}{2} \sum_{i=-1}^{n-2} \left(\frac{(2i+3)!!(2n-2i-3)!!}{2^{n+1}} \right) \partial_{\hat{t}_i} \partial_{\hat{t}_{n-3-i}}. \quad (3.33)$$

Removing $\hat{t}_{-1} = -t_0$

In this section we derive operators \hat{L}_n , for all $n \geq 0$ that annihilate the restriction $e^{\mathcal{F}}|_{\hat{t}_{-1}=0}$. From the operator L_{-1} we have:

$$\partial_{\hat{t}_{-1}} e^{\mathcal{F}} = - \left(\sum_{i=0}^{\infty} \frac{\hat{t}_{i+1}}{\hat{t}_0} \partial_{\hat{t}_i} + \frac{\hat{t}_{-1}^2}{2\hat{t}_0} \right) e^{\mathcal{F}}. \quad (3.34)$$

We may write the operators L_n making sure that any monomial containing $\partial_{\hat{t}_{-1}}$ has it as the right-most term. Then replacing $\partial_{\hat{t}_{-1}}$ with the right hand side of (3.34) produces an operator \tilde{L}_n still annihilating $e^{\mathcal{F}}$ and not containing any derivative in \hat{t}_{-1} . The application of \tilde{L}_n commutes with restriction to the hyperplane $\hat{t}_{-1} = 0$, so we may define $\hat{L}_n = \left(\tilde{L}_n \right)_{|\hat{t}_{-1}=0}$. Up to some tedious but straightforward computation we have proved the following.

Lemma 3.4.4. *For all $n \geq 0$, the operators \hat{L}_n defined below annihilate $(e^{\mathcal{F}})_{|\hat{t}_{-1}=0}$:*

$$\hat{L}_0 = \sum_{i=0}^{\infty} \frac{(2i+3)}{2} \hat{t}_i \partial_{\hat{t}_i} + \frac{1}{16}, \quad (3.35)$$

$$\begin{aligned} \hat{L}_1 = & \sum_{i=0}^{\infty} \frac{(2i+3)(2i+5)}{4} \hat{t}_i \partial_{\hat{t}_{i+1}} + \\ & + \frac{\lambda^2}{8\hat{t}_0^2} \left(\sum_{i=0}^{\infty} \left(\hat{t}_{i+2} - \frac{\hat{t}_1 \hat{t}_{i+1}}{\hat{t}_0} \right) \partial_{\hat{t}_i} + \sum_{i,j=0}^{\infty} \hat{t}_{i+1} \hat{t}_{j+1} \partial_{\hat{t}_i} \partial_{\hat{t}_j} \right), \end{aligned} \quad (3.36)$$

$$\begin{aligned} \hat{L}_2 = & \sum_{i=0}^{\infty} \frac{(2i+3)(2i+5)(2i+7)}{8} \hat{t}_i \partial_{\hat{t}_{i+2}} + \\ & + \frac{3\lambda^2}{8\hat{t}_0^2} \left(\sum_{i=0}^{\infty} (\hat{t}_{i+1} (1 - \hat{t}_0 \partial_{\hat{t}_0})) \partial_{\hat{t}_i} \right), \end{aligned} \quad (3.37)$$

$$\begin{aligned} \hat{L}_n = & \sum_{i=0}^{\infty} \left(\frac{(2i+2n+3)!!}{(2i+1)!! 2^{n+1}} \right) \hat{t}_i \partial_{\hat{t}_{i+n}} \\ & + \frac{\lambda^2}{2} \sum_{i=0}^{n-3} \left(\frac{(2i+3)!!(2n-2i-3)!!}{2^{n+1}} \right) \partial_{\hat{t}_i} \partial_{\hat{t}_{n-3-i}} + \end{aligned}$$

$$-\frac{\lambda^2 (2n-1)!!}{\hat{t}_0^{2^{n+1}}} \left(\partial_{\hat{t}_{n-3}} + \sum_{i=0}^{\infty} \hat{t}_{i+1} \partial_{\hat{t}_i} \partial_{\hat{t}_{n-2}} \right). \quad (3.38)$$

The need to treat the first three cases separately comes from the fact that the variable \hat{t}_0 and the remaining variables appear asymmetrically in the right hand side of (3.34). We now rewrite these operators in the variables \hat{p}_k . We separate the computation in two parts, corresponding to the coefficients of λ^0 and λ^2 in the operators. We start by carrying out explicitly the change of variable for the first operator.

Warm-up: \hat{L}_0

We first focus on the term

$$\sum_{i=0}^{\infty} \hat{t}_i \partial_{\hat{t}_i} = \sum_{i=0}^{\infty} \hat{t}_i \sum_{j=0}^{\infty} \frac{\partial \hat{p}_m}{\partial \hat{t}_i} \partial_{\hat{p}_m}. \quad (3.39)$$

Consider the change of variables (3.29). By taking a partial derivative with respect to a variable \hat{t}_i , we obtain:

$$\sum_{j=0}^{\infty} \frac{\partial \hat{p}_j}{\partial \hat{t}_i} z^{j-i} = \exp \left(- \sum_{k=0}^{\infty} \hat{p}_k z^k \right). \quad (3.40)$$

We observe that (3.40) holds for any fixed value of i , which implies that the partial derivatives $\frac{\partial \hat{p}_j}{\partial \hat{t}_i}$ depend only on the difference $j - i$. In other words, the Jacobian of the change of variables may be thought as an infinite upper triangular matrix which is constant along translates of the diagonal. It follows that the coefficient of $\partial_{\hat{p}_m}$ in (3.39) is the coefficient of z^m in the product of generating series:

$$\begin{aligned} \sum_{i=0}^{\infty} \hat{t}_i \partial_{\hat{t}_i} &= \sum_{m=0}^{\infty} \left[\left(\sum_{i=0}^{\infty} \hat{t}_i z^i \right) \left(\sum_{j=0}^{\infty} \frac{\partial \hat{p}_j}{\partial \hat{t}_i} z^{j-i} \right) \right]_{z^m} \partial_{\hat{p}_m} \\ &= \sum_{m=0}^{\infty} \left[\exp \left(\sum_{k=0}^{\infty} \hat{p}_k z^k \right) \exp \left(- \sum_{k=0}^{\infty} \hat{p}_k z^k \right) \right]_{z^m} \partial_{\hat{p}_m} = \partial_{\hat{p}_0}. \end{aligned}$$

We return to the change of variables (3.29) and apply the operator $z\partial_z$ to obtain

$$\sum_{i=0}^{\infty} i \hat{t}_i z^i = \exp \left(\sum_{k=0}^{\infty} \hat{p}_k z^k \right) \sum_{k=0}^{\infty} k \hat{p}_k z^k \quad (3.41)$$

With an analogous argument to the previous case, we obtain:

$$\begin{aligned} \sum_{i=0}^{\infty} i \hat{t}_i \partial_{\hat{t}_i} &= \sum_{m=0}^{\infty} \left[\left(\exp \left(\sum_{k=0}^{\infty} \hat{p}_k z^k \right) \sum_{k=0}^{\infty} k \hat{p}_k z^k \right) \left(\exp \left(- \sum_{k=0}^{\infty} \hat{p}_k z^k \right) \right) \right]_{z^m} \partial_{\hat{p}_m} \\ &= \sum_{m=0}^{\infty} m \hat{p}_m \partial_{\hat{p}_m}. \end{aligned}$$

We may now express the operator \hat{L}_0 in the variables $p_i = -\hat{p}_i$ as

$$\hat{L}_0 = \sum_{i=0}^{\infty} \frac{(2i+3)}{2} \hat{t}_i \partial_{\hat{t}_i} + \frac{1}{16} = -\frac{3}{2} \partial_{p_0} + \sum_{m=0}^{\infty} m p_m \partial_{p_m} + \frac{1}{16}. \quad (3.42)$$

One may recognize that $\hat{L}_0(e^{\mathcal{K}}) = 0$ (which implies $\hat{L}_0(\mathcal{K}) = 1/24$), is equivalent to the statement that κ_0 on $\overline{\mathcal{M}}_g$ has degree $2g - 2$ (Lemma 1.3.11).

Bell polynomials

We now focus on the λ^0 coefficients of the operators \hat{L}_n , with $n > 0$. As a preliminary step, we change variables to expressions of the form:

$$\sum_{i=0}^{\infty} i^d \hat{t}_i z^i = (z\partial_z)^d \left(\sum_{i=0}^{\infty} \hat{t}_i z^i \right). \quad (3.43)$$

Iterated applications of the operator $z\partial_z$ to the right hand side of (3.29) are described by a variation of the classical *Faà di Bruno formula* [36,37], giving the result in terms of Bell polynomials [38].

Definition 3.4.5. For $d \geq 0$, the d -th **Bell polynomial** $B_d(x_1, \dots, x_d)$ is defined by

$$\sum_{d=0}^{\infty} B_d(x_1, \dots, x_d) \frac{y^d}{d!} = \exp \left(\sum_{j=1}^{\infty} x_j \frac{y^j}{j!} \right). \quad (3.44)$$

The first few Bell polynomials are

$$B_0 = 1,$$

$$B_1 = x_1$$

$$B_2 = x_2 + x_1^2$$

$$B_3 = x_3 + 3x_2x_1 + x_1^3$$

The coefficient of a monomial $\prod x_j^{m_j}$ in the Bell polynomial B_n (with $n = \sum jm_j$) counts the number of ways to partition a set with n elements into a collection of m_1 unlabeled subsets of cardinality 1, m_2 unlabeled subsets of cardinality 2, etc.

Lemma 3.4.6. For all $i \geq 0$, let

$$\hat{q}_i = \sum_{k=0}^{\infty} k^i \hat{p}_k z^k.$$

Then,

$$(z\partial_z)^d e^{\hat{q}_0} = e^{\hat{q}_0} B_d(\hat{q}_1, \hat{q}_2, \dots, \hat{q}_d). \quad (3.45)$$

Proof. This statement is a ready adaptation of the classical Faà di Bruno formula, which expresses the successive derivatives of a composite function $f(g(z))$ in terms of derivatives of f and of g . In our case the function f is an exponential function, hence all of its derivatives are equal to itself, and since we are replacing the derivation operator with $z\partial_z$ the \hat{q}_i 's play the role of the successive derivatives of g . While it is at this point an exercise to complete the proof this way, we also provide a brief sketch of a bijective proof, which we find more conceptually satisfactory. Note that $z\partial_z \hat{q}_i = \hat{q}_{i+1}$, and that applying $z\partial_z$ to $e^{\hat{q}_0} \hat{q}_{i_1} \cdots \hat{q}_{i_n}$ results in a sum of terms, where one term is obtained by multiplying m by \hat{q}_1 , i.e. , the other terms are obtained by raising by one one of the indices of one of the \hat{q}_{i_j} . Now let us imagine performing successive applications of $z\partial_z$ to $e^{\hat{q}_0}$ maintaining at all times all summands distinct, and let us call "level i " the i -th application of the operator. We want to put in bijection the number of times a term of the form $e^{\hat{q}_0} \hat{q}_{i_1} \cdots \hat{q}_{i_n}$ appears (necessarily at level $d = i_1 + \cdots + i_n$) with the number of partitions of the set $[d]$ in n subsets

of cardinality i_1, \dots, i_n . For each variable \hat{q}_{i_j} , there are i_j distinct levels where the index of such variable has been increased. We associate to such variable the subset of such levels, and by running over all variables that are appearing we obtain a partition of $[d]$. It is at this point easy to see that this construction realizes the bijection we desire. We illustrate our proof in a simple example. Consider $(z\partial_z)^3 e^{\hat{q}_0} = 3e^{\hat{q}_0} \hat{q}_2 \hat{q}_1 + \dots$ and let us observe that 3 is obtained as the ways to partition the set $[3]$ into two subsets of size 2 and 1. First we write out all levels up to 3:

$$\text{Level 1: } e_0^{\hat{q}} \hat{q}_1$$

$$\text{Level 2: } e_0^{\hat{q}} \bar{\hat{q}}_1 \hat{q}_1 + e_0^{\hat{q}} \hat{q}_2$$

$$\text{Level 3: } e_0^{\hat{q}} \bar{\bar{\hat{q}}}_1 \bar{\hat{q}}_1 \hat{q}_1 + e_0^{\hat{q}} \bar{\hat{q}}_2 \bar{\hat{q}}_1 + e_0^{\hat{q}} \bar{\hat{q}}_1 \bar{\hat{q}}_2 + e_0^{\hat{q}} \bar{\bar{\hat{q}}}_1 \hat{q}_2 + e_0^{\hat{q}} \hat{q}_3$$

The bars over the variables are purely combinatorial decorations that keep track of at which level a given variable appears. We then observe that the monomials that reduce to $e^{\hat{q}_0} \hat{q}_2 \hat{q}_1$ when forgetting the decorations are in bijection with two part non-trivial partitions of $[3]$ where the singleton corresponds to the level where the variable \hat{q}_1 appears, and the two part subset corresponds to two levels: the level where the variable first appears as a \hat{q}_1 and the level where its index is raised by one. \square

Lemma 3.4.7. *With notation as in Lemma 3.4.6, for any nonnegative integers n, d we have:*

$$\sum_{i=0}^{\infty} i^d \hat{t}_i \partial_{\hat{t}_{i+n}} = \sum_{m=0}^{\infty} [B_d(\hat{q}_1, \dots, \hat{q}_d)]_{z^m} \partial_{\hat{p}_{m+n}}. \quad (3.46)$$

Proof. In analogy to the computations in Section 3.4, we have

$$\begin{aligned} \sum_{i=0}^{\infty} i^d \hat{t}_i \partial_{\hat{t}_{i+n}} &= \sum_{m=0}^{\infty} \left[(z\partial_z)^d e^{\hat{q}_0} \left(\sum_{j=0}^{\infty} \frac{\partial \hat{p}_j}{\partial \hat{t}_{i+n}} z^{j-i-n} \right) \right]_{z^{m-n}} \partial_{\hat{p}_m} \\ &= \sum_{m=0}^{\infty} [e^{\hat{q}_0} B_d(\hat{q}_1, \dots, \hat{q}_d) e^{-\hat{q}_0}]_{z^{m-n}} \partial_{\hat{p}_m}, \end{aligned}$$

and the result follows from canceling the exponential terms and reindexing the summation. \square

Lemma 3.4.7 allows to perform the change of variables for the λ^0 coefficient of the operators \hat{L}_n .

Lemma 3.4.8. For $n \geq 0$, let $(i + \frac{3}{2})(i + \frac{5}{2}) \cdots (i + \frac{2n+3}{2}) = \sum_{d=0}^{n+1} \alpha_{n,d} i^d$. Then:

$$[\hat{L}_n]_{\lambda^0} = \sum_{d=0}^{n+1} \alpha_{n,d} \left(\sum_{m=0}^{\infty} [B_d(\hat{q}_1, \dots, \hat{q}_d)]_{z^m} \partial_{\hat{p}_{m+n}} \right). \quad (3.47)$$

We now turn our attention to the λ^2 coefficient.

The λ^2 coefficient: $n \geq 2$.

We recall that from (3.40) we can express:

$$\partial_{\hat{t}_i} = \sum_{j=0}^{\infty} \frac{\partial \hat{p}_j}{\partial \hat{t}_i} \partial_{\hat{p}_j} = e^{-\hat{p}_0} \sum_{j=0}^{\infty} S_{j-i}(-\hat{\mathbf{p}}) \partial_{\hat{p}_j}. \quad (3.48)$$

It will be useful to take the partial derivative of (3.40) with respect to a variable \hat{p}_m to obtain:

$$\sum_{j=0}^{\infty} \frac{\partial^2 \hat{p}_j}{\partial \hat{p}_m \partial \hat{t}_i} z^{j-i-m} = - \exp \left(- \sum_{k=0}^{\infty} \hat{p}_k z^k \right). \quad (3.49)$$

We may now use generating functions to perform the change of variables for an operator of second order:

$$\begin{aligned} \partial_{\hat{t}_i} \partial_{\hat{t}_i} &= \left(\sum_{m=0}^{\infty} \frac{\partial \hat{p}_m}{\partial \hat{t}_i} \partial_{\hat{p}_m} \right) \left(\sum_{j=0}^{\infty} \frac{\partial \hat{p}_j}{\partial \hat{t}_i} \partial_{\hat{p}_j} \right) \\ &= \sum_{j,m=0}^{\infty} \frac{\partial \hat{p}_m}{\partial \hat{t}_i} \frac{\partial \hat{p}_j}{\partial \hat{t}_i} \partial_{\hat{p}_m} \partial_{\hat{p}_j} + \sum_{m=0}^{\infty} \frac{\partial \hat{p}_m}{\partial \hat{t}_i} \sum_{j=0}^{\infty} \frac{\partial^2 \hat{p}_j}{\partial \hat{p}_m \partial \hat{t}_i} \partial_{\hat{p}_j} \\ &= \sum_{j,m=0}^{\infty} e^{-2\hat{p}_0} S_{m-l}(-\hat{\mathbf{p}}) S_{j-i}(-\hat{\mathbf{p}}) \partial_{\hat{p}_m} \partial_{\hat{p}_j} + \\ &+ \sum_{j=0}^{\infty} \left[\left(\exp \left(- \sum_{k=0}^{\infty} \hat{p}_k z^k \right) \right) \left(- \exp \left(- \sum_{k=0}^{\infty} \hat{p}_k z^k \right) \right) \right]_{z^{j-i-l}} \partial_{\hat{p}_j} \\ &= e^{-2\hat{p}_0} \left(\sum_{j,m=0}^{\infty} S_{m-l}(-\hat{\mathbf{p}}) S_{j-i}(-\hat{\mathbf{p}}) \partial_{\hat{p}_m} \partial_{\hat{p}_j} - \sum_{j=0}^{\infty} S_{j-i-l}(-2\hat{\mathbf{p}}) \partial_{\hat{p}_j} \right). \end{aligned} \quad (3.50)$$

The last expression that needs to be addressed to complete the change of variables for \hat{L}_n , $n \geq 3$ is:

$$\begin{aligned}
\sum_{i=0}^{\infty} \hat{t}_{i+1} \partial_{\hat{t}_i} \partial_{\hat{t}_{n-2}} &= \sum_{i=0}^{\infty} \left(\sum_{m=0}^{\infty} \hat{t}_{i+1} \frac{\partial \hat{p}_m}{\partial \hat{t}_i} \partial_{\hat{p}_m} \right) \left(\sum_{j=0}^{\infty} \frac{\partial \hat{p}_j}{\partial \hat{t}_{n-2}} \partial_{\hat{p}_j} \right) \\
&= \sum_{i,j,m=0}^{\infty} \hat{t}_{i+1} \frac{\partial \hat{p}_m}{\partial \hat{t}_i} \frac{\partial \hat{p}_j}{\partial \hat{t}_{n-2}} \partial_{\hat{p}_m} \partial_{\hat{p}_j} + \sum_{i,m=0}^{\infty} \hat{t}_{i+1} \frac{\partial \hat{p}_m}{\partial \hat{t}_i} \sum_{j=0}^{\infty} \frac{\partial^2 \hat{p}_j}{\partial \hat{p}_m \partial \hat{t}_{n-2}} \partial_{\hat{p}_j} \\
&= \sum_{j,m=0}^{\infty} \left[\left(e^{\sum_{k=0}^{\infty} \hat{p}_k z^k} - e^{\hat{p}_0} \right) \left(e^{-\sum_{k=0}^{\infty} \hat{p}_k z^k} \right) \right]_{z^{m+1}} e^{-\hat{p}_0} S_{j-n+2}(-\hat{\mathbf{p}}) \partial_{\hat{p}_m} \partial_{\hat{p}_j} \\
&+ \sum_{j=0}^{\infty} \left[\left(e^{\sum_{k=0}^{\infty} \hat{p}_k z^k} - e^{\hat{p}_0} \right) \left(e^{-\sum_{k=0}^{\infty} \hat{p}_k z^k} \right) \left(-e^{-\sum_{k=0}^{\infty} \hat{p}_k z^k} \right) \right]_{z^{j-n+3}} \partial_{\hat{p}_j} \\
&= e^{-\hat{p}_0} \left(\sum_{j,m=0}^{\infty} -S_{m+1}(-\hat{\mathbf{p}}) S_{j-n+2}(-\hat{\mathbf{p}}) \partial_{\hat{p}_m} \partial_{\hat{p}_j} \right. \\
&\quad \left. + \sum_{j=0}^{\infty} (S_{j-n+3}(-2\hat{\mathbf{p}}) - S_{j-n+3}(-\hat{\mathbf{p}})) \partial_{\hat{p}_j} \right). \tag{3.51}
\end{aligned}$$

$$\begin{aligned}
&+ \sum_{j=0}^{\infty} (S_{j-n+3}(-2\hat{\mathbf{p}}) - S_{j-n+3}(-\hat{\mathbf{p}})) \partial_{\hat{p}_j} \Big). \tag{3.52}
\end{aligned}$$

To deal with the case $n = 2$, we compute:

$$\begin{aligned}
\sum_{i=0}^{\infty} \hat{t}_{i+1} \partial_{\hat{t}_i} &= \sum_{i=0}^{\infty} \left(\sum_{m=0}^{\infty} \hat{t}_{i+1} \frac{\partial \hat{p}_m}{\partial \hat{t}_i} \partial_{\hat{p}_m} \right) \\
&= \sum_{m=0}^{\infty} \left[\left(e^{\sum_{k=0}^{\infty} \hat{p}_k z^k} - e^{\hat{p}_0} \right) \left(e^{-\sum_{k=0}^{\infty} \hat{p}_k z^k} \right) \right]_{z^{m+1}} \partial_{\hat{p}_m} \\
&= \sum_{m=0}^{\infty} -S_{m+1}(-\hat{\mathbf{p}}) \partial_{\hat{p}_m}. \tag{3.53}
\end{aligned}$$

Combining (3.48), (3.50), (3.52), (3.53) and appropriately reindexing we obtain the following.

Lemma 3.4.9. For $n \geq 2$

$$\begin{aligned}
[\hat{L}_n]_{\lambda^2} &= -\frac{e^{-2\hat{p}_0}}{2} \left(\sum_{i=0}^{n-1} \frac{(2i+1)!!(2n-2i-1)!!}{2^{n+1}} \right) \left(\sum_{j=0}^{\infty} S_j(-2\hat{\mathbf{p}}) \partial_{\hat{p}_{j+n-3}} \right) + \\
&+ \frac{e^{-2\hat{p}_0}}{2} \left(\sum_{i=0}^{n-1} \frac{(2i+1)!!(2n-2i-1)!!}{2^{n+1}} \sum_{j,m=0}^{\infty} S_m(-\hat{\mathbf{p}}) S_j(-\hat{\mathbf{p}}) \partial_{\hat{p}_{m+n-2-i}} \partial_{\hat{p}_{j+i-1}} \right). \tag{3.54}
\end{aligned}$$

The λ^2 coefficient: $n = 1$.

In order to compute \hat{L}_1 we must perform the following computations:

$$\begin{aligned}
\sum_{i=0}^{\infty} \hat{t}_{i+2} \partial_{\hat{t}_i} &= \sum_{i=0}^{\infty} \left(\sum_{m=0}^{\infty} \hat{t}_{i+2} \frac{\partial \hat{p}_m}{\partial \hat{t}_i} \partial_{\hat{p}_m} \right) = \\
&= \sum_{m=0}^{\infty} \left[\left(\exp \left(\sum_{k=0}^{\infty} \hat{p}_k z^k \right) - e^{\hat{p}_0} (1 + \hat{p}_1 z) \right) \left(\exp \left(- \sum_{k=0}^{\infty} \hat{p}_k z^k \right) \right) \right]_{z^{m+2}} \partial_{\hat{p}_m} \\
&= \sum_{m=0}^{\infty} S_1(-\hat{\mathbf{p}}) S_{m+1}(-\hat{\mathbf{p}}) - S_{m+2}(-\hat{\mathbf{p}}) \partial_{\hat{p}_m}. \tag{3.55}
\end{aligned}$$

$$\sum_{i=0}^{\infty} \frac{\hat{t}_1 \hat{t}_{i+1}}{\hat{t}_0} \partial_{\hat{t}_i} = \sum_{m=0}^{\infty} S_1(-\hat{\mathbf{p}}) S_{m+1}(-\hat{\mathbf{p}}) \partial_{\hat{p}_m}. \tag{3.56}$$

$$\begin{aligned}
\sum_{i,j=0}^{\infty} \hat{t}_{i+1} \hat{t}_{j+1} \partial_{\hat{t}_i} \partial_{\hat{t}_j} &= \sum_{i,j=0}^{\infty} \hat{t}_{i+1} \hat{t}_{j+1} \left(\sum_{l=0}^{\infty} \frac{\partial \hat{p}_l}{\partial \hat{t}_i} \partial_{\hat{p}_l} \right) \left(\sum_{m=0}^{\infty} \frac{\partial \hat{p}_m}{\partial \hat{t}_j} \partial_{\hat{p}_m} \right) \\
&= \sum_{i,j,l,m=0}^{\infty} \hat{t}_{i+1} \hat{t}_{j+1} \frac{\partial \hat{p}_l}{\partial \hat{t}_i} \frac{\partial \hat{p}_m}{\partial \hat{t}_j} \partial_{\hat{p}_l} \partial_{\hat{p}_m} + \sum_{i,j,l=0}^{\infty} \hat{t}_{i+1} \hat{t}_{j+1} \frac{\partial \hat{p}_l}{\partial \hat{t}_i} \sum_{m=0}^{\infty} \frac{\partial^2 \hat{p}_m}{\partial \hat{p}_l \partial \hat{t}_j} \partial_{\hat{p}_m} \\
&= \sum_{l,m=0}^{\infty} \left[\left(e^{\sum_{k=0}^{\infty} \hat{p}_k z^k} - e^{\hat{p}_0} \right) \left(e^{-\sum_{k=0}^{\infty} \hat{p}_k z^k} \right) \right]_{z^{l+1}} \left[\left(e^{\sum_{k=0}^{\infty} \hat{p}_k z^k} - e^{\hat{p}_0} \right) \left(e^{-\sum_{k=0}^{\infty} \hat{p}_k z^k} \right) \right]_{z^{m+1}} \partial_{\hat{p}_l} \partial_{\hat{p}_m} \\
&+ \sum_{m=0}^{\infty} \left[\left(e^{\sum_{k=0}^{\infty} \hat{p}_k z^k} - e^{\hat{p}_0} \right)^2 \left(e^{-\sum_{k=0}^{\infty} \hat{p}_k z^k} \right) \left(-e^{-\sum_{k=0}^{\infty} \hat{p}_k z^k} \right) \right]_{z^{m+2}} \partial_{\hat{p}_m} \\
&= \left(\sum_{l,m=0}^{\infty} S_{l+1}(-\hat{\mathbf{p}}) S_{m+1}(-\hat{\mathbf{p}}) \partial_{\hat{p}_l} \partial_{\hat{p}_m} + \sum_{m=0}^{\infty} (2S_{m+2}(-\hat{\mathbf{p}}) - S_{m+2}(-2\hat{\mathbf{p}})) \partial_{\hat{p}_m} \right). \tag{3.57}
\end{aligned}$$

Combining the results of (3.55), (3.56), (3.57), we obtain the following.

Lemma 3.4.10.

$$[\hat{L}_1]_{\lambda^2} = \frac{e^{-2\hat{p}_0}}{8} \left(\sum_{m=0}^{\infty} (S_{m+2}(-\hat{\mathbf{p}}) - S_{m+2}(-2\hat{\mathbf{p}})) \partial_{\hat{p}_m} + \sum_{l,m=0}^{\infty} S_{l+1}(-\hat{\mathbf{p}}) S_{m+1}(-\hat{\mathbf{p}}) \partial_{\hat{p}_l} \partial_{\hat{p}_m} \right).$$

Concluding the Proof of Theorem 3.4.2

The first part of Theorem 3.4.2 is proved by combining the results of Lemmas 3.4.4, 3.4.8, 3.4.9 and 3.4.10 and switching back to the unhatted variables $p_k = -\hat{p}_k$. To prove that the recursions obtained from the vanishing of coefficients of $L_n(e^{\mathcal{K}})$ reconstruct \mathcal{K} from the "unstable" term $1/24p_0$, one observes that each \hat{L}_n has a term of the form $A\partial_{p_n}$, with $A \in \mathbb{Q} \setminus \{0\}$; this means that the vanishing of a coefficient of $L_n(e^{\mathcal{K}})$ compares the intersection number of a monomial m containing κ_n with a combination of other intersection numbers determined by the remaining terms of \hat{L}_n . A direct analysis of the remaining terms shows that the monomials that are compared to m are either strictly shorter than m , or they correspond to intersection numbers on lower genus. This proves that any monomial can inductively be computed from the "genus one" term $1/24p_0$. We illustrate this strategy for $g = 2, 3$ in the next section.

3.5 Recursions for κ -Classes

In this section we collect some of the relations among κ -classes that are produced by the vanishing of coefficients of $\hat{L}_n(e^{\mathcal{K}})$. We choose to exhibit a set of relations that inductively reconstruct all intersection numbers in genus 2 and 3. Throughout this section we denote $[\kappa^I]_g := \int_{\overline{\mathcal{M}}_g} \kappa^I$. We extend this notation to the unstable term, and define $[\kappa_0]_1 := \frac{1}{24}$. For $g \geq 2$, we only consider monomials with no factor of κ_0 , since $[\kappa^I \kappa_0^n]_g = (2g-2)^n [\kappa^I]_g$. In genus 2, we have the following:

$$\begin{aligned} \left[\hat{L}_3(e^{\mathcal{K}}) \right]_1 & : [\kappa_3]_2 & = \frac{13}{630} [\kappa_0]_1 + \frac{1}{210} [\kappa_0]_1^2 = \frac{1}{1152} \\ \left[\hat{L}_1(e^{\mathcal{K}}) \right]_{p_2} & : [\kappa_2 \kappa_1]_2 & = \frac{48}{15} [\kappa_3]_2 + \frac{1}{30} [\kappa_0]_1 = \frac{1}{240} \\ \left[\hat{L}_1(e^{\mathcal{K}}) \right]_{p_1^2} & : [\kappa_1^3]_2 & = \frac{8}{3} [\kappa_2 \kappa_1]_2 - \frac{8}{15} [\kappa_3]_2 + \frac{1}{15} [\kappa_0]_1^2 + \frac{1}{10} [\kappa_0]_1 = \frac{43}{2880} \end{aligned}$$

A set of reconstructing relations in genus 3 is given by:

$$\begin{aligned}
\left[\hat{L}_6(e^{\mathcal{K}}) \right]_1 &: [\kappa_6]_3 &= \frac{1}{99}[\kappa_3]_2 + \frac{1}{1287}[\kappa_2\kappa_1]_2 + \frac{1}{715}[\kappa_3]_2[\kappa_0]_1 \\
\left[\hat{L}_1(e^{\mathcal{K}}) \right]_{p_5} &: [\kappa_5\kappa_1]_3 &= 12[\kappa_6]_3 + \frac{1}{30}[\kappa_3]_2 \\
\left[\hat{L}_2(e^{\mathcal{K}}) \right]_{p_4} &: [\kappa_4\kappa_2]_3 &= \frac{136}{7}[\kappa_6]_3 + \frac{4}{35}[\kappa_3]_2 + \frac{1}{35}[\kappa_3]_2[\kappa_0]_1 \\
\left[\hat{L}_3(e^{\mathcal{K}}) \right]_{p_3} &: [\kappa_3^2]_3 &= \frac{136}{7}[\kappa_6]_3 + \frac{38}{315}[\kappa_3]_2 + \frac{1}{63}[\kappa_2\kappa_1]_2 - [\kappa_3]_2^2 + \frac{31}{630}[\kappa_3]_2[\kappa_0]_1 \\
&&&+ \frac{1}{210}[\kappa_3]_2[\kappa_0]_1^2 \\
\left[\hat{L}_1(e^{\mathcal{K}}) \right]_{p_4p_1} &: [\kappa_4\kappa_1^2]_3 &= -\frac{32}{15}[\kappa_6]_3 + \frac{128}{15}[\kappa_5\kappa_1]_3 + \frac{4}{3}[\kappa_4\kappa_2]_3 + \frac{7}{30}[\kappa_3]_2 + \frac{1}{30}[\kappa_2\kappa_1]_2 \\
&&&+ \frac{1}{15}[\kappa_3]_2[\kappa_0]_1 \\
\left[\hat{L}_1(e^{\mathcal{K}}) \right]_{p_3p_2} &: [\kappa_3\kappa_2\kappa_1]_3 &= -\frac{16}{5}[\kappa_6]_3 + \frac{28}{5}[\kappa_4\kappa_2]_3 + \frac{16}{5}[\kappa_3^2]_3 + \frac{1}{6}[\kappa_3]_2 + \frac{1}{10}[\kappa_2\kappa_1]_2 + \frac{16}{5}[\kappa_3]_2^2 \\
&&&- [\kappa_3]_2[\kappa_2\kappa_1]_2 + \frac{1}{30}[\kappa_3]_2[\kappa_0]_1 \\
\left[\hat{L}_2(e^{\mathcal{K}}) \right]_{p_2^2} &: [\kappa_2^3]_3 &= -\frac{288}{35}[\kappa_6]_3 + \frac{56}{5}[\kappa_4\kappa_2]_3 + \frac{6}{35}[\kappa_3]_2 + \frac{2}{7}[\kappa_2\kappa_1]_2 + \frac{1}{35}[\kappa_3]_2[\kappa_0]_1 \\
&&&+ \frac{2}{35}[\kappa_2\kappa_1]_2[\kappa_0]_1 \\
\left[\hat{L}_1(e^{\mathcal{K}}) \right]_{p_2^2p_1} &: [\kappa_2^2\kappa_1^2]_3 &= -\frac{32}{15}[\kappa_5\kappa_1]_3 - \frac{32}{15}[\kappa_4\kappa_2]_3 + \frac{32}{5}[\kappa_3\kappa_2\kappa_1]_3 + \frac{4}{3}[\kappa_2^3]_3 + \frac{11}{30}[\kappa_3]_2 \\
&&&+ \frac{5}{6}[\kappa_2\kappa_1]_2 + \frac{1}{15}[\kappa_1^3]_2 + \frac{32}{5}[\kappa_3]_2[\kappa_2\kappa_1]_2 - 2[\kappa_2\kappa_1]_2^2 \\
&&&+ \frac{1}{15}[\kappa_3]_2[\kappa_0]_1 + \frac{1}{5}[\kappa_2\kappa_1]_2[\kappa_0]_1 \\
\left[\hat{L}_1(e^{\mathcal{K}}) \right]_{p_3p_1^2} &: [\kappa_3\kappa_1^3]_3 &= -\frac{16}{5}[\kappa_5\kappa_1]_3 - \frac{8}{15}[\kappa_3^2]_3 + \frac{28}{5}[\kappa_4\kappa_1^2]_3 + \frac{8}{3}[\kappa_3\kappa_2\kappa_1]_3 + \frac{29}{30}[\kappa_3]_2 \\
&&&+ \frac{8}{15}[\kappa_2\kappa_1]_2 + \frac{1}{30}[\kappa_1^3]_2 - \frac{8}{15}[\kappa_3]_2^2 + \frac{8}{3}[\kappa_3]_2[\kappa_2\kappa_1]_2 \\
&&&- [\kappa_3]_2[\kappa_1^3]_2 + \frac{1}{2}[\kappa_3]_2[\kappa_0]_1 + \frac{2}{15}[\kappa_2\kappa_1]_2[\kappa_0]_1 + \frac{1}{15}[\kappa_3]_2[\kappa_0]_1^2 \\
\left[\hat{L}_1(e^{\mathcal{K}}) \right]_{p_2p_1^3} &: [\kappa_2\kappa_1^4]_3 &= -\frac{16}{5}[\kappa_4\kappa_1^2]_3 - \frac{8}{5}[\kappa_3\kappa_2\kappa_1]_3 + \frac{16}{5}[\kappa_3\kappa_1^3]_3 + 4[\kappa_2^2\kappa_1^2]_3 + \frac{9}{10}[\kappa_3]_2 \\
&&&+ \frac{19}{5}[\kappa_2\kappa_1]_2 + \frac{29}{30}[\kappa_1^3]_2 - \frac{8}{5}[\kappa_3]_2[\kappa_2\kappa_1]_2 + \frac{16}{5}[\kappa_3]_2[\kappa_1^3]_2 \\
&&&+ 8[\kappa_2\kappa_1]_2^2 - 4[\kappa_2\kappa_1]_2[\kappa_1^3]_2 + \frac{1}{5}[\kappa_3]_2[\kappa_0]_1 + \frac{17}{10}[\kappa_2\kappa_1]_2[\kappa_0]_1 \\
&&&+ \frac{7}{30}[\kappa_1^3]_2[\kappa_0]_1 + \frac{1}{5}[\kappa_2\kappa_1]_2[\kappa_0]_1^2 \\
\left[\hat{L}_1(e^{\mathcal{K}}) \right]_{p_1^5} &: [\kappa_1^6]_3 &= -\frac{16}{3}[\kappa_3\kappa_1^3]_3 + \frac{20}{3}[\kappa_2\kappa_1^4]_3 + \frac{17}{10}[\kappa_3]_2 + \frac{35}{6}[\kappa_2\kappa_1]_2 + 12[\kappa_1^3]_2 \\
&&&- \frac{16}{3}[\kappa_3]_2[\kappa_1^3]_2 + \frac{80}{3}[\kappa_2\kappa_1]_2[\kappa_1^3]_2 - 10[\kappa_1^3]_2^2 + \frac{1}{3}[\kappa_3]_2[\kappa_0]_1 \\
&&&+ \frac{4}{3}[\kappa_2\kappa_1]_2[\kappa_0]_1 + \frac{17}{3}[\kappa_1^3]_2[\kappa_0]_1 + \frac{2}{3}[\kappa_1^3]_2[\kappa_0]_1^2
\end{aligned}$$

Chapter 4

Hassett Space Intersections

In this chapter we focus on the intersection theory of weighted ψ -classes coming from Hassett spaces. The ω -classes from Chapter 3 can be seen as pullbacks of weighted ψ -classes on Hassett spaces with arbitrarily small (non-zero) weights (see Remark 4.1.8); because of this, the proofs of many statements in this chapter will mirror those of Chapter 3 with only minor alterations. For this reason, we will omit full proofs and instead reference their Chapter 3 counterparts unless we believe there is new content to be highlighted.

We begin by defining Hassett spaces, their ψ -classes, and noting some properties of each (Section 4.1). We then relate weighted ψ -class intersections to traditional ψ -classes (Section 4.2) and echo the generating function and differential operator story from Chapter 3 in Section 4.3 and Section 4.4.

4.1 Definition and Basic Results

Hassett spaces were first introduced in [13] as a family of birational compactifications of $\mathcal{M}_{g,n}$ constructed via the log minimal model program.

Definition 4.1.1. Fix (ordered) weight data $\mathcal{A} = (a_1, a_2, \dots, a_n)$ so that $a_i \in (0, 1] \cap \mathbb{Q}$ and $a_i \geq a_{i+1}$. A (nodal) marked curve $(C; p_1, \dots, p_n)$ is **\mathcal{A} -stable** if

- $p_i \in C$ is smooth for every $i \in [n]$;
- $\omega_C + \sum_{i=1}^n a_i p_i$ is ample; and
- for every point $x \in C$, we have $\sum_{p_i=x} a_i \leq 1$.

The **Hassett space** $\overline{\mathcal{M}}_{g,\mathcal{A}}$ is the moduli space of \mathcal{A} -stable curves of genus g up to isomorphism.

When weight data is **diagonal**, i.e. $a_1 = a_2 = \dots = a_n = a$, we write $\mathcal{A} = a^n$.

Remark 4.1.2. Define the **total weight** of a point $x \in C$ to be $\sum_{p_i=x} a_i$ if x is smooth and 1 if x is a node. The total weight of an irreducible component is the sum of the total weights of all of its points. The second condition of \mathcal{A} -stability may be reinterpreted to say that the rational components of an \mathcal{A} -stable curve C have total weight greater than two and the genus one components have total weight greater than zero.

When $2g - 2 + \sum a_i > 0$, the Hassett space $\overline{\mathcal{M}}_{g,\mathcal{A}}$ is a non-empty, smooth, proper Deligne-Mumford stack. In analogy with $\overline{\mathcal{M}}_{g,n}$, Hassett spaces have forgetful morphisms; for generic³ weight data

$$\pi_{n+1} : \overline{\mathcal{U}}_{g,\mathcal{A}} \rightarrow \overline{\mathcal{M}}_{g,\mathcal{A}} \quad (4.1)$$

identifies the universal curve with $\overline{\mathcal{M}}_{g,\hat{\mathcal{A}}}$ for $\hat{\mathcal{A}} = (a_1, \dots, a_n, \epsilon)$ for ϵ sufficiently small. The universal family has n **tautological sections**

$$\sigma_i : \overline{\mathcal{M}}_{g,\mathcal{A}} \rightarrow \overline{\mathcal{U}}_{g,\mathcal{A}}, \quad (4.2)$$

where the i -th section assigns to $(C; p_1, \dots, p_n)$ the point p_i in the fiber over $(C; p_1, \dots, p_n)$ in the universal curve.

Hassett spaces also have gluing and clutching morphisms and **tautological subrings** $R^*(\overline{\mathcal{M}}_{g,\mathcal{A}})$ of their Chow rings $A^*(\overline{\mathcal{M}}_{g,\mathcal{A}})$, which are defined analogously to the tautological ring for $\overline{\mathcal{M}}_{g,n}$.

The Hassett space $\overline{\mathcal{M}}_{g,1^n}$ coincides with the Deligne-Mumford compactification $\overline{\mathcal{M}}_{g,n}$. More generally, the key difference between \mathcal{A} -stable curves and Deligne-Mumford stable curves is that the former may have marked points come together provided the combined weight is low enough.

For fixed n , there is a partial ordering on weight data: $\mathcal{A} \succeq \mathcal{B}$ if $a_i \geq b_i$ for all $i \in [n]$. Given $\mathcal{A} \succeq \mathcal{B}$, there exists a birational **reduction morphism**

³Generic here means that there is no subset $J \subseteq [n]$ with $\sum_{j \in J} a_j = 1$. One may remove the genericity requirement by allowing points to have weight 0; see [13].

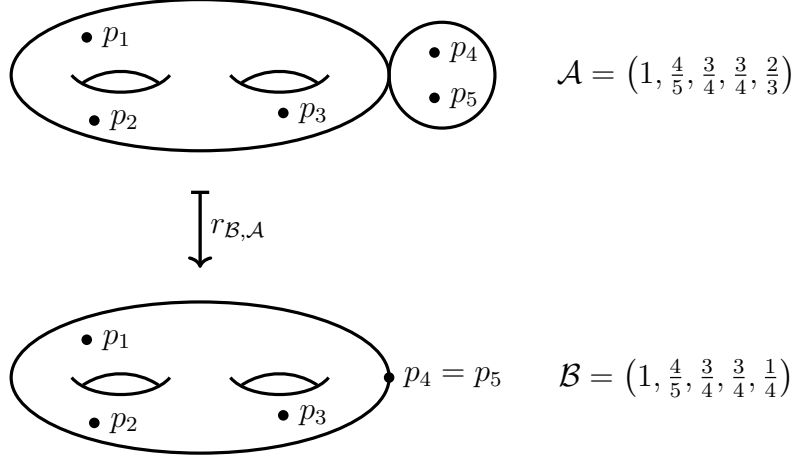

Figure 4.1: An example of the action of a reduction morphism on curves. On top, $a_4 + a_5 > 1$, but on the bottom, $b_4 + b_5 \leq 1$.

$$r_{\mathcal{B},\mathcal{A}} : \overline{\mathcal{M}}_{g,\mathcal{A}} \rightarrow \overline{\mathcal{M}}_{g,\mathcal{B}}, \quad (4.3)$$

which on the level of curves reduces the weights and stabilizes if necessary by contracting unstable rational components (see Figure 4.1). The space $\overline{\mathcal{M}}_{g,n}$ admits reduction morphisms to all other Hassett spaces; for a given \mathcal{A} we call this reduction a **contraction morphism** and denote it

$$c_{\mathcal{A}} : \overline{\mathcal{M}}_{g,n} \rightarrow \overline{\mathcal{M}}_{g,\mathcal{A}}. \quad (4.4)$$

All appropriate forgetful, reduction, contraction morphisms commute and induce maps on the tautological rings of the relevant Hassett spaces. We use the contraction morphisms to identify special boundary strata in $\overline{\mathcal{M}}_{g,n}$.

Definition 4.1.3. A boundary stratum Δ in $\overline{\mathcal{M}}_{g,n}$ is **\mathcal{A} -stable** if the topological type of the general curve parametrized by Δ does not change under the application of $c_{\mathcal{A}}$. Otherwise Δ is **\mathcal{A} -unstable**.

Hassett spaces also admit ψ -classes, which are the protagonists of the remainder of the chapter.

Definition 4.1.4. Fix weight data \mathcal{A} . For each $i \in [n]$, the class $\psi_{i,\mathcal{A}} \in R^1(\overline{\mathcal{M}}_{g,\mathcal{A}})$ is defined to be

$$\psi_{i,\mathcal{A}} := c_1(\sigma_i^*(\omega_{\pi}))$$

where c_1 is the first Chern class, ω_π denotes the relative dualizing sheaf of the universal family $\pi : \overline{\mathcal{U}}_{g,\mathcal{A}} \rightarrow \overline{\mathcal{M}}_{g,\mathcal{A}}$, and $\sigma_i : \overline{\mathcal{M}}_{g,\mathcal{A}} \rightarrow \overline{\mathcal{U}}_{g,\mathcal{A}}$ is the i -th tautological section. These are called **\mathcal{A} -weighted ψ -classes** or just **weighted ψ -classes** when the weight data is clear.

Remark 4.1.5. When $\mathcal{A} = 1^n$, we omit the weight data and write $\psi_{i,1^n} = \psi_i$, since this is the standard i -th ψ -class on $\overline{\mathcal{M}}_{g,n}$.

Weighted ψ -classes are generally unstable under pullback along reduction morphisms in a way reminiscent of unweighted ψ -classes and forgetful morphisms. The next lemma makes this precise.

Lemma 4.1.6 ([34, Lemma 5.3]). *For weight data $\mathcal{A} \succeq \mathcal{B}$,*

$$\psi_{i,\mathcal{A}} = r_{\mathcal{B},\mathcal{A}}^* \psi_{i,\mathcal{B}} + D, \quad (4.5)$$

where D is the sum of all boundary divisors whose generic element is a nodal curve with a genus g component attached to a rational tail containing the i -th marked point and which is \mathcal{A} -stable but not \mathcal{B} -stable.

When $r_{\mathcal{B},\mathcal{A}} = c_{\mathcal{B}}$, the condition on the divisorial correction simplifies to be the sum of divisors which correspond to boundary strata which are \mathcal{B} -unstable in the sense of Definition 4.1.3.

Example 4.1.7. Let $\mathcal{B} = (\frac{7}{8}, \frac{2}{3}, \frac{1}{3}, \frac{1}{4}, \frac{1}{6})$.

$$\begin{aligned} c_{\mathcal{B}}^* \psi_{1,\mathcal{B}} &= \psi_1 \\ c_{\mathcal{B}}^* \psi_{2,\mathcal{B}} &= \psi_2 - D(\{1, 4, 5\} | \{2, 3\}) - D(\{1, 3, 5\} | \{2, 4\}) - D(\{1, 3, 4\} | \{2, 5\}) \\ c_{\mathcal{B}}^* \psi_{3,\mathcal{B}} &= \psi_3 - D(\{1, 4, 5\} | \{2, 3\}) - D(\{1, 2, 5\} | \{3, 4\}) - D(\{1, 2, 4\} | \{3, 5\}) \\ &\quad - D(\{1, 2\} | \{3, 4, 5\}) \end{aligned}$$

The classes $\psi_{4,\mathcal{B}}$ and $\psi_{5,\mathcal{B}}$ pull back analogously to $\psi_{3,\mathcal{B}}$.

Remark 4.1.8. By comparing Lemma 1.3.7 and Lemma 4.1.6, we see that if $a_i \leq \frac{1}{n}$ for all i , then

$$c_{\mathcal{A}}^* \psi_{i,\mathcal{A}} = \omega_i.$$

The next two lemmas describe how weighted ψ -classes restrict to boundary divisors depending upon the \mathcal{A} -stability of the divisors; the former concerns \mathcal{A} -stable divisors and the latter \mathcal{A} -unstable divisors.

Lemma 4.1.9. *Fix weight data $\mathcal{A} = (a_1, \dots, a_n)$. Let $D = D(P|Q)$ be an \mathcal{A} -stable divisor of rational tails type on $\overline{\mathcal{M}}_{g,n}$. Then for any non-negative integer k*

$$c_{\mathcal{A}}^* \psi_{i,\mathcal{A}}^k \cdot D = gl_{D*}(\psi_i^k). \quad (4.6)$$

Proof. Let \mathcal{A}_P (resp. \mathcal{A}_Q) denote the weight data corresponding to points in P (resp. Q), and let $D_{\mathcal{A}}$ be the pushforward of D under $c_{\mathcal{A}}$. Because D is \mathcal{A} -stable, the restriction $c_{\mathcal{A}}|_D$ is an isomorphism onto its image, and the claim follows from the commutivity of the following diagram (where we assume $\bullet_{\mathcal{A}}$ and $\star_{\mathcal{A}}$ have weight 1).

$$\begin{array}{ccc} \overline{\mathcal{M}}_{g,P \cup \{\bullet\}} \times \overline{\mathcal{M}}_{0,Q \cup \{\star\}} & \xrightarrow{c_{\mathcal{A}}|_D} & \overline{\mathcal{M}}_{g,\mathcal{A}_P \cup \{\bullet_{\mathcal{A}}\}} \times \overline{\mathcal{M}}_{0,\mathcal{A}_Q \cup \{\star_{\mathcal{A}}\}} \\ \downarrow gl_D & & \downarrow gl_{D_{\mathcal{A}}} \\ \overline{\mathcal{M}}_{g,n} & \xrightarrow{c_{\mathcal{A}}} & \overline{\mathcal{M}}_{g,\mathcal{A}} \end{array}$$

□

Lemma 4.1.10. *Fix weight data $\mathcal{A} = (a_1, \dots, a_n)$. Let $D = D(P|Q)$ be an \mathcal{A} -unstable divisor of rational tails type on $\overline{\mathcal{M}}_{g,n}$, and suppose the i -th marked point is on the rational component ($i \in Q$). Then for any non-negative integer k*

$$c_{\mathcal{A}}^* \psi_{i,\mathcal{A}}^k \cdot D = gl_{D*}(c_{\mathcal{B}}^* \psi_{\bullet,\mathcal{B}}^k), \quad (4.7)$$

where $c_{\mathcal{B}}^* \psi_{\bullet,\mathcal{B}}$ denotes the class pulled back from the projection $pr : \overline{\mathcal{M}}_{g,P \cup \{\bullet\}} \times \overline{\mathcal{M}}_{0,Q \cup \{\star\}} \rightarrow \overline{\mathcal{M}}_{g,P \cup \{\bullet\}}$, and $\mathcal{B} = (a_{i_1}, \dots, a_{\ell}, s)$ with $s = \min\left(1, \sum_{i \in Q} a_i\right)$.

Proof. Without loss of generality, let $i = n$. Fix a divisor $D(P|Q)$ of rational tails type on $\overline{\mathcal{M}}_{g,n}$ with $P = \{i_1, \dots, i_{\ell}\}$ and $Q = \{i_{\ell+1}, \dots, i_n = n\}$, and suppose that $D(P|Q)$ is \mathcal{A} -unstable. Let

$s = \min\left(1, \sum_{i \in Q} a_i\right)$, define $\tilde{D} := c_{\mathcal{A}}(D) = \{[C; p_1, \dots, p_n] : p_{i_{\ell+1}} = \dots = p_{i_n}\} \subset \overline{\mathcal{M}}_{g, \mathcal{A}}$, and define weight data $\mathcal{B} = (a_{i_1}, \dots, a_{i_\ell}, s)$.

Consider the following diagram (ι is inclusion):

$$\begin{array}{ccc}
\overline{\mathcal{M}}_{g, P \cup \{\bullet\}} \times \overline{\mathcal{M}}_{0, Q \cup \{\star\}} & \xrightarrow{pr} & \overline{\mathcal{M}}_{g, P \cup \{\bullet\}} \\
\downarrow gl_D & & \downarrow c_{\mathcal{B}} \\
& & \overline{\mathcal{M}}_{g, \mathcal{B}} \cong \tilde{D} \\
& & \downarrow \iota \\
\overline{\mathcal{M}}_{g, n} & \xrightarrow{c_{\mathcal{A}}} & \overline{\mathcal{M}}_{g, \mathcal{A}}
\end{array}$$

By the commutativity of the diagram,

$$\begin{aligned}
c_{\mathcal{A}}^* \psi_{n, \mathcal{A}}^k \cdot D(P|Q) &= gl_{D*} gl_D^* (c_{\mathcal{A}}^* \psi_{n, \mathcal{A}}^k) \\
&= gl_{D*} pr^* c_{\mathcal{B}}^* (\psi_{n, \mathcal{A}}^k) \\
&= gl_{D*} (c_{\mathcal{B}}^* \psi_{\bullet, \mathcal{B}}^k). \quad \square
\end{aligned}$$

4.2 Cycle Theorem for Weighted ψ -classes

Intersections of pullbacks of \mathcal{A} -weighted ψ -classes have a highly combinatorial structure which relates them to classical ψ -class intersections. In fact, all of the combinatorics ultimately reduces to the intersection theory of the genus zero case, as seen below. First, we define the strata in $R^*(\overline{\mathcal{M}}_{g, n})$ which support such intersections.

Definition 4.2.1. Fix weight data $\mathcal{A} = (a_1, \dots, a_n)$. A partition $\mathcal{P} = \{P_1, \dots, P_r\} \vdash [n]$ is **\mathcal{A} -unstable** if $\sum_{i \in P_j} a_i \leq 1$ for each part P_j . The set of all \mathcal{A} -unstable partitions is denoted $\mathfrak{P}_{\mathcal{A}}$.

If $\mathcal{A} = 1^n$, then the only \mathcal{A} -unstable partition is the singleton partition $\{\{1\}, \dots, \{n\}\}$, and if $a_i \leq \frac{1}{n}$ for all i , then all partitions are \mathcal{A} -unstable. The partial ordering on weight data is reversed for unstable partitions: if $\mathcal{A} \succeq \mathcal{B}$, then $\mathfrak{P}_{\mathcal{A}} \subseteq \mathfrak{P}_{\mathcal{B}}$.

Remark 4.2.2. Other than the singleton partition, pinwheel strata which correspond to \mathcal{A} -unstable partitions are \mathcal{A} -unstable in the sense of Definition 4.1.3; because of this, we write $[\Delta] \in \mathfrak{P}_{\mathcal{A}}$ if Δ is \mathcal{A} -unstable. In fact, the generic curve parametrized by an unstable (nontrivial) pinwheel stratum is "maximally unstable" in that every rational component of the curve is destabilizing.

The intersection of weighted ψ -classes and pinwheel strata is analogous to that of weighted ψ -classes and divisors.

Corollary 4.2.3. *Fix weight data $\mathcal{A} = (a_1, \dots, a_n)$. For a pinwheel stratum $\Delta_{\mathcal{P}}$, if the i -th marked point is on a rational component which contracts under $c_{\mathcal{A}}$, and without loss of generality $i \in P_1 \in \mathcal{P}$, then*

$$c_{\mathcal{A}}^* \psi_{i, \mathcal{A}}^k \cdot \Delta_{\mathcal{P}} = gl_{\mathcal{P}*}(\psi_{\bullet_1}^k), \quad (4.8)$$

where ψ_{\bullet_1} denotes the class pulled back from the projection

$$pr : \overline{\mathcal{M}}_{g, \{\bullet_1, \dots, \bullet_r\}} \times \prod_{|P_i| > 1} \overline{\mathcal{M}}_{0, \{\ast_i\} \cup P_i} \rightarrow \overline{\mathcal{M}}_{g, \{\bullet_1, \dots, \bullet_r\}}.$$

Otherwise, if the i -th marked point is on a component which does not contract under $c_{\mathcal{A}}$, then

$$c_{\mathcal{A}}^* \psi_{i, \mathcal{A}}^k \cdot \Delta_{\mathcal{P}} = gl_{\mathcal{P}*}(\psi_i^k). \quad (4.9)$$

Proof. Both statements follow immediately from Lemma 4.1.9 and Lemma 4.1.10. \square

We are now ready to state and prove this section's first main theorem, of which Theorem 3.1.2 is a specialization when $\mathcal{A} \rightarrow (\epsilon, \dots, \epsilon)$ for sufficiently small ϵ .

Theorem 4.2.4. *Fix g and n and weight data $\mathcal{A} = (a_1, \dots, a_n)$. For $1 \leq i \leq n$, let k_i be a non-negative integer, and let $K = \sum_{i=1}^n k_i$. For a partition $\mathcal{P} = \{P_1, \dots, P_r\} \vdash [n]$, define $\alpha_j := \sum_{i \in P_j} k_i$.*

Then the following formula holds in $R^K(\overline{\mathcal{M}}_{g,n})$:

$$c_{\mathcal{A}}^* \left(\prod_{i=1}^n \psi_{i,\mathcal{A}}^{k_i} \right) = \sum_{\mathcal{P} \in \mathfrak{P}_{\mathcal{A}}} [\Delta_{\mathcal{P}}] \prod_{j=1}^{|\mathcal{P}|} \frac{\psi_{\bullet_j}^{\alpha_j}}{(-\psi_{\bullet_j} - \psi_{\star_j})^{1-\delta_j}}, \quad (4.10)$$

where $\delta_j = \delta_{1,|P_j|}$ is a Kronecker delta, and we follow the standard convention of considering negative powers of ψ equal to 0.

Proof. The proof consists of an induction on n and the total power $K = \sum_{i=1}^n k_i$. Then we proceed by induction on (n, K) in lexical order: we assume the formula holds for all pairs (n, K) with $n < n_0$ or $n = n_0$ and $K \leq K_0$, and prove it for $(n_0, K_0 + 1)$.

We begin with the base case $K = 1$ for every n . On the left-hand side of (4.10), we have, without loss of generality, $c_{\mathcal{A}}^* \psi_{1,\mathcal{A}}$. On the right-hand side, the pinwheel stratum corresponding to the singleton partition $\mathcal{P} = \{\{1\}, \{2\}, \dots, \{n\}\}$ is $\overline{\mathcal{M}}_{g,n}$; it appears in (4.10) with coefficient ψ_1 . Non-zero contributions only come from strata where each part of size greater than one has a point with non-zero k_1 . In this case, this only leaves partitions with exactly one part P_j of size greater than one; further, it must be that $1 \in P_j$ and $\mathcal{P} \in \mathfrak{P}_{\mathcal{A}}$. We have $[\Delta_{\mathcal{P}}] = D([n] \setminus P_j | P_j)$, $\alpha_j = 1$, and all other α equal to zero. The coefficient from P_j is

$$\frac{\psi_{\bullet_j}}{-\psi_{\bullet_j} - \psi_{\star_j}} = -1 + \frac{\psi_{\star_j}}{\psi_{\bullet_j}} - \dots = -1.$$

All other parts are singletons with $\alpha = 0$, and hence each contributes $\frac{\psi_0}{1} = 1$ to the product. Thus equation (4.10) becomes

$$c_{\mathcal{A}}^* \psi_{1,\mathcal{A}} = \psi_1 - \sum_{\substack{1 \in B \\ D(A|B) \in \mathfrak{P}_{\mathcal{A}}}} D(A|B), \quad (4.11)$$

which we have seen in Lemma 4.1.6. Thus the base case is established.

Assume (4.10) holds for total monomial power $K \leq m$ for some $m \in \mathbb{N}$ and for all spaces with fewer than n marked points. We hold n fixed and increase K by 1 by multiplying, again without

loss of generality, by $c_{\mathcal{A}}^* \psi_{1,\mathcal{A}}$. We have

$$\begin{aligned} c_{\mathcal{A}}^* \left(\prod_{i=1}^n \psi_{i,\mathcal{A}}^{k_i} \right) \cdot c_{\mathcal{A}}^* \psi_{1,\mathcal{A}} &= c_{\mathcal{A}}^* \left(\prod_{i=1}^n \psi_{i,\mathcal{A}}^{k_i} \right) \left(\psi_1 - \sum_{\substack{1 \in B \\ D(A|B) \in \mathfrak{P}_{\mathcal{A}}}} D(A|B) \right) \\ &= c_{\mathcal{A}}^* \left(\prod_{i=1}^n \psi_{i,\mathcal{A}}^{k_i} \right) \cdot \psi_1 - \sum_{\substack{1 \in B \\ D(A|B) \in \mathfrak{P}_{\mathcal{A}}}} c_{\mathcal{A}}^* \left(\prod_{i=1}^n \psi_{i,\mathcal{A}}^{k_i} \right) D(A|B). \end{aligned} \quad (4.12)$$

We may assume $1 \in P_1$. We examine each of the summands on the right-hand side of (4.12). For the first term, by inductive hypothesis we have

$$\begin{aligned} c_{\mathcal{A}}^* \left(\prod_{i=1}^n \psi_{i,\mathcal{A}}^{k_i} \right) \cdot \psi_1 &= \left(\sum_{\mathcal{P} \in \mathfrak{P}_{\mathcal{A}}} [\Delta_{\mathcal{P}}] \prod_{j=1}^{\ell(\mathcal{P})} \frac{\psi_{\bullet_j}^{\alpha_j}}{(-\psi_{\bullet_j} - \psi_{\star_j})^{1-\delta_j}} \right) \cdot \psi_1 \\ &= \sum_{|P_1|=1} [\Delta_{\mathcal{P}}] \prod_{j=2}^{\ell(\mathcal{P})} \frac{\psi_{\bullet_j}^{\alpha_j}}{(-\psi_{\bullet_j} - \psi_{\star_j})^{1-\delta_j}} \cdot \psi_1^{k_1+1} \\ &\quad + \sum_{|P_1|>1} ([\Delta_{\mathcal{P}}] \cdot \psi_1) \prod_{j=1}^{\ell(\mathcal{P})} \frac{\psi_{\bullet_j}^{\alpha_j}}{(-\psi_{\bullet_j} - \psi_{\star_j})^{1-\delta_j}}. \end{aligned} \quad (4.13)$$

Note that for the $|P_1| = 1$ cases, the denominator for the $j = 1$ term is 1, as $\delta_1 = \delta_{1,|P_1|} = 1$, and $\{\bullet_1\} = \{1\}$ by the convention adopted in defining $[\Delta_{\mathcal{P}}]$.

We now turn to the second summand in (4.12). We rename $B = P_1$ to emphasize that the point 1 belongs to this subset; now $A = [n] \setminus P_1 = \{i_1, \dots, i_{\ell}\}$ and note that summing over all divisors $D(A|B)$ with $1 \in B$ is equivalent to summing over all $|P_1| > 1$ by the stability requirement on rational components. We denote $gl_{P_1} : \overline{\mathcal{M}}_{g,A \cup \{L_1\}} \times \overline{\mathcal{M}}_{0,P_1 \cup \{R_1\}} \rightarrow \overline{\mathcal{M}}_{g,n}$ the gluing morphism whose image is $D(A|P_1)$. Let $s = \min(1, \sum_{i \in P_1} a_i)$; then we have:

$$\begin{aligned} \sum_{\substack{1 \in B \\ D(A|B) \in \mathfrak{P}_{\mathcal{A}}}} c_{\mathcal{A}}^* \left(\prod_{i=1}^n \psi_{i,\mathcal{A}}^{k_i} \right) D(A|B) &= \sum_{|P_1|>1} c_{\mathcal{A}}^* \left(\prod_{i=1}^n \psi_{i,\mathcal{A}}^{k_i} \right) D(A|P_1) \\ &\stackrel{\text{Lemma 4.1.10}}{=} \sum_{|P_1|>1} gl_{P_1*} \left[c_{\mathcal{A}}^* \left(\prod_{i \in A} \psi_{i,\mathcal{A}}^{k_i} \right) \cdot c_{\mathcal{B}}^* \left(\psi_{L_1, \mathcal{B}}^{\sum_{j \in P_1} k_j} \right) \right] \end{aligned}$$

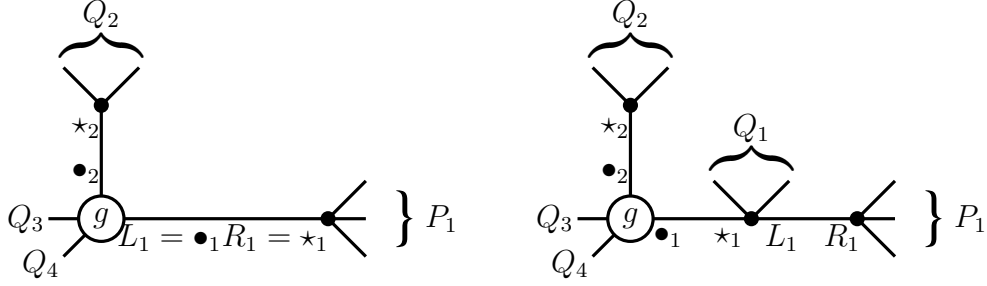

Figure 4.2: Examples of dual graphs corresponding to the two summands in equation (4.15). On the left-hand side we have graphs where $Q_1 = \{L_1\}$; on the right-hand side $|Q_1| > 1$.

$$= \sum_{|P_1|>1} gl_{P_1*} \left(\sum_{\mathcal{Q} \in \mathfrak{P}_{\mathcal{B}}} [\Delta_{\mathcal{Q}}] \prod_{j=1}^{\ell(\mathcal{Q})} \frac{\psi_{\bullet_j}^{\alpha_j}}{(-\psi_{\bullet_j} - \psi_{\star_j})^{1-\delta_j}} \right) \quad (4.14)$$

where $\mathcal{B} = (a_{i_1}, \dots, a_{i_\ell}, a_{L_1} = s)$.

The last equality follows from induction with respect to the number of marks. Adopting the convention that $L_1 \in Q_1$, we note that $\alpha_1 = \sum_{i \in Q_1 \cup P_1} k_i$. We now group the partitions \mathcal{Q} in two groups: the first is where Q_1 is the singleton $\{L_1\}$: in this case $gl_{P_1*}([\Delta_{\mathcal{Q}}])$ is the class of the pinwheel stratum $\Delta_{\mathcal{P}}$, where $\mathcal{P} = P_1 \cup \mathcal{Q} \setminus Q_1$. The second group contains all partitions \mathcal{Q} with $|Q_1| > 1$. See Figure 4.2 for a pictorial description. Then (4.14) continues:

$$\begin{aligned} &= \sum_{|P_1|>1} [\Delta_{\mathcal{P}}] \prod_{j=2}^{\ell(\mathcal{P})} \frac{\psi_{\bullet_j}^{\alpha_j}}{(-\psi_{\bullet_j} - \psi_{\star_j})^{1-\delta_j}} \cdot \psi_{\bullet_1}^{\alpha_1} \\ &\quad + \sum_{|P_1|>1} \sum_{|Q_1|>1} gl_{P_1*} \left([\Delta_{\mathcal{Q}}] \cdot \frac{\psi_{\bullet_1}^{\alpha_1}}{(-\psi_{\bullet_1} - \psi_{\star_1})^{1-\delta_1}} \prod_{j=2}^{\ell(\mathcal{Q})} \frac{\psi_{\bullet_j}^{\alpha_j}}{(-\psi_{\bullet_j} - \psi_{\star_j})^{1-\delta_j}} \right) \\ &= \sum_{|P_1|>1} [\Delta_{\mathcal{P}}] \prod_{j=2}^{\ell(\mathcal{P})} \frac{\psi_{\bullet_j}^{\alpha_j}}{(-\psi_{\bullet_j} - \psi_{\star_j})^{1-\delta_j}} \cdot \psi_{\bullet_1}^{\alpha_1} \\ &\quad + \sum_{|P_1|>1} [\Delta_{\mathcal{P}}] \prod_{j=1}^{\ell(\mathcal{P})} \frac{\psi_{\bullet_j}^{\alpha_j}}{(-\psi_{\bullet_j} - \psi_{\star_j})^{1-\delta_j}} \cdot (\psi_1 + \psi_{\star_1}) \end{aligned} \quad (4.15)$$

In the last equality we have applied Lemma 1.3.16, and reindexed the sum so that the new P_1 is equal to what used to be $P_1 \cup (Q_1 \setminus L_1)$.

We rewrite (4.12) using (4.13) and (4.15); the second term in the right-hand side of (4.13) cancels part of the second term of the right-hand side of (4.15), and we obtain:

$$\begin{aligned}
c_{\mathcal{A}}^* \left(\prod_{i=1}^n \psi_{i,\mathcal{A}}^{k_i} \right) \cdot c_{\mathcal{A}}^* \psi_{1,\mathcal{A}} &= \sum_{|P_1|=1} [\Delta_{\mathcal{P}}] \prod_{j=2}^{\ell(\mathcal{P})} \frac{\psi_{\bullet_j}^{\alpha_j}}{(-\psi_{\bullet_j} - \psi_{\star_j})^{1-\delta_j}} \cdot \psi_1^{k_1+1} \\
&\quad - \sum_{|P_1|>1} [\Delta_{\mathcal{P}}] \prod_{j=2}^{\ell(\mathcal{P})} \frac{\psi_{\bullet_j}^{\alpha_j}}{(-\psi_{\bullet_j} - \psi_{\star_j})^{1-\delta_j}} \cdot \psi_{\bullet_1}^{\alpha_1} \\
&\quad - \sum_{|P_1|>1} [\Delta_{\mathcal{P}}] \prod_{j=1}^{\ell(\mathcal{P})} \frac{\psi_{\bullet_j}^{\alpha_j}}{(-\psi_{\bullet_j} - \psi_{\star_j})^{1-\delta_j}} \cdot \psi_{\star_1} \\
&= \sum_{|P_1|=1} [\Delta_{\mathcal{P}}] \prod_{j=2}^{\ell(\mathcal{P})} \frac{\psi_{\bullet_j}^{\alpha_j}}{(-\psi_{\bullet_j} - \psi_{\star_j})^{1-\delta_j}} \cdot \psi_1^{k_1+1} \\
&\quad + \sum_{|P_1|>1} [\Delta_{\mathcal{P}}] \prod_{j=2}^{\ell(\mathcal{P})} \frac{\psi_{\bullet_j}^{\alpha_j}}{(-\psi_{\bullet_j} - \psi_{\star_j})^{1-\delta_j}} \cdot \left(-\psi_{\bullet_1}^{\alpha_1} - \psi_{\star_1} \frac{\psi_{\bullet_1}^{\alpha_1}}{(-\psi_{\bullet_1} - \psi_{\star_1})} \right).
\end{aligned} \tag{4.16}$$

We conclude the proof by observing that (4.16) gives formula (4.10), with k_1 replaced by $k_1 + 1$ (and hence every occurrence of α_1 replaced by $\alpha_1 + 1$): the first summand shows that the coefficients agree on the nose for partitions with $P_1 = \{1\}$; the second summand deals with partitions where $|P_1| > 1$; the coefficients match after noting the elementary identity:

$$\begin{aligned}
\frac{\psi_{\bullet_1}^{\alpha_1+1}}{-\psi_{\bullet_1} - \psi_{\star_1}} &= -\psi_{\bullet_1}^{\alpha_1} + \psi_{\bullet_1}^{\alpha_1-1} \psi_{\star_1} - \psi_{\bullet_1}^{\alpha_1-2} \psi_{\star_1}^2 + \dots \\
&= -\psi_{\bullet_1}^{\alpha_1} - \psi_{\star_1} \cdot (-\psi_{\bullet_1}^{\alpha_1-1} + \psi_{\bullet_1}^{\alpha_1-2} \psi_{\star_1} - \dots). \quad \square
\end{aligned}$$

By restricting our attention to top-dimensional intersections, we obtain as a corollary to Theorem 4.2.4 the following numerical result originally shown in [34].

Corollary 4.2.5. *For $1 \leq i \leq n$, let k_i be a non-negative integer, and let $\sum_{i=1}^n k_i = 3g - 3 + n$. Then*

$$\int_{\overline{\mathcal{M}}_{g,\mathcal{A}}} \prod_{i=1}^n \psi_{i,\mathcal{A}}^{k_i} = \sum_{\mathcal{P} \in \mathfrak{P}_{\mathcal{A}}} (-1)^{n+\ell(\mathcal{P})} \int_{\overline{\mathcal{M}}_{g,\ell(\mathcal{P})}} \prod_{i=1}^{\ell(\mathcal{P})} \psi_i^{\alpha_i - |P_i| + 1} \quad (4.17)$$

Proof. This statement follows from formula (4.10) by observing which monomials are of top degree and then pushing forward from $\overline{\mathcal{M}}_{g,n}$ to $\overline{\mathcal{M}}_{g,\mathcal{A}}$.

- For any partition \mathcal{P} , for dimension reasons the only monomial that has nonzero evaluation on $[\Delta_{\mathcal{P}}]$ is

$$\prod_{|P_i|=1} \psi_{\bullet_i}^{\alpha_i} \prod_{|P_i|>1} (-1)^{|P_i|-1} \psi_{\bullet_i}^{\alpha_i - |P_i| + 1} \psi_{\star_i}^{|P_i|-2} \quad (4.18)$$

- For any $n \geq 3$ and $i \in [n]$,

$$\int_{\overline{\mathcal{M}}_{0,n}} \psi_i^{n-3} = 1$$

by the string equation; hence all evaluations for the classes ψ_{\star_i} in (4.18) contribute a factor of one to the evaluation of the monomial on $[\Delta_{\mathcal{P}}]$. \square

Remark 4.2.6. It is worth observing that natural generalizations of Theorem 4.2.4 and Corollary 4.2.5 hold as well: if instead of pulling back along $c_{\mathcal{A}}$ to $\overline{\mathcal{M}}_{g,n}$ we pull back to some intermediate $\overline{\mathcal{M}}_{g,\mathcal{B}}$ along $r_{\mathcal{A},\mathcal{B}}$, the only change is that the sums in (4.10) and (4.17) are over

$$(\mathfrak{P}_{\mathcal{A}} \setminus \mathfrak{P}_{\mathcal{B}}) \cup \{\{1\}, \dots, \{n\}\},$$

i.e., non-singleton \mathcal{A} -unstable partitions which are not also \mathcal{B} -unstable. The proof of this more general statement is essentially identical to the one given above, but the notation becomes significantly more tedious. One benefit (which we will not explore in more detail at present) of the generalized statements is that they exhibit the ψ -class relations as a wall-crossing phenomenon in $((0, 1] \cap \mathbb{Q})^n$, the parameter space for weight data.

4.3 Hassett Potentials and Operators

We again choose to encode intersection data via potentials (generating functions). In this way, recursions among intersection numbers and relations between different families of intersection numbers may again be expressed via differential operators. The definitions here are primarily generalizations of those given in Section 3.2.

Definition 4.3.1. For weight data $\mathcal{A} = (a_1, \dots, a_n)$ and fixed g , define **correlation functions** as

$$\langle \tau_{a_1, k_1} \cdots \tau_{a_n, k_n} \rangle_g := \int_{\overline{\mathcal{M}}_{g, \mathcal{A}}} \prod_{i=1}^n \psi_{i, \mathcal{A}}^{k_i}. \quad (4.19)$$

We collect terms, set $\tau_{\mathcal{A}} = (\tau_{a_1, 0}, \tau_{a_2, 0}, \dots, \tau_{a_n, \ell})$, and set $\mathbf{b} = (b_{1,0}, b_{2,0}, \dots, b_{n,\ell})$ to adopt the multi-index notation

$$\langle \tau_{\mathcal{A}}^{\mathbf{b}} \rangle_g := \langle \underbrace{(\tau_{a_1, 0} \cdots \tau_{a_1, 0})}_{b_{1,0} \text{ factors}} \cdots \underbrace{(\tau_{a_n, 0} \cdots \tau_{a_n, 0})}_{b_{n,0} \text{ factors}} \cdots \underbrace{(\tau_{a_1, \ell} \cdots \tau_{a_1, \ell})}_{b_{1,\ell} \text{ factors}} \cdots \underbrace{(\tau_{a_n, \ell} \cdots \tau_{a_n, \ell})}_{b_{n,\ell} \text{ factors}} \rangle_g. \quad (4.20)$$

If $2g - 2 + \sum a_i \leq 0$, we define the integral to be zero.

Definition 4.3.2. For weight data $\mathcal{A} = (a_1, \dots, a_n)$, set $\mathbf{t}_{\mathcal{A}} = (t_{a_1, 0}, t_{a_2, 0}, \dots, t_{a_n, \ell})$, set $\mathbf{t} = \cup_{\mathcal{A}} \mathbf{t}_{\mathcal{A}}$, and, using the same multi-index notation as above, define the **Hassett potential of genus g** to be

$$\mathcal{H}_g(\mathbf{t}) := \sum_{\mathcal{A}, \mathbf{b}} \frac{\mathbf{t}_{\mathcal{A}}^{\mathbf{b}}}{\mathbf{b}!} \langle \tau_{\mathcal{A}}^{\mathbf{b}} \rangle_g, \quad (4.21)$$

where $\mathbf{b}! = b_{1,0}! b_{1,1}! \cdots b_{n,\ell}!$. The **Hassett potential** is then

$$\mathcal{H}(\lambda; \mathbf{t}) := \sum_{g=0}^{\infty} \lambda^{2g-2} \mathcal{H}_g(\mathbf{t}). \quad (4.22)$$

Example 4.3.3. The monomial $\lambda^4 \frac{1}{2!} t_{\frac{1}{2},5} t_{\frac{1}{3},2}^2$ in $\mathcal{H}(\lambda; \mathbf{t})$ has coefficient

$$\int_{\overline{\mathcal{M}}_{3,\mathcal{A}}} \psi_{1,\mathcal{A}}^5 \psi_{2,\mathcal{A}}^2 \psi_{3,\mathcal{A}}^2,$$

where $\mathcal{A} = (\frac{1}{2}, \frac{1}{3}, \frac{1}{3})$.

Definition 4.3.4. Let $\mathbf{x} = (x_0, x_1, x_2, \dots)$ be an infinite sequence of formal variables. The **Witten potential** or **Gromov-Witten potential of a point**, denoted $\mathcal{F}(\lambda; \mathbf{x})$ is the Hassett potential restricted to weight data of the form $\mathcal{A} = 1^n$ for any n . Equivalently, $\mathcal{F}(\lambda; \mathbf{x})$ is the Hassett potential with the substitution

$$t_{a,k} \mapsto \begin{cases} 0, & \text{if } a \neq 1 \\ x_k, & \text{if } a = 1 \end{cases}$$

The Hassett potential is related to the Witten potential as prescribed by Corollary 4.2.5. This connection is made explicit in the language of generating functions via the following differential operator.

Definition 4.3.5. Let $\partial x := \frac{\partial}{\partial x}$. The **Hassett fork operator** is

$$\mathcal{L} := \sum_{n=1}^{\infty} \frac{(-1)^{n-1}}{n!} \sum_{\substack{(a_1, i_1), \dots, (a_n, i_n) \\ \sum a_j \leq 1}} t_{a_1, i_1} \cdots t_{a_n, i_n} \partial x_{i_1 + \dots + i_n - (n-1)}. \quad (4.23)$$

The exponential of this operator relates the Witten potential to the Hassett potential. The proof of this theorem is in complete analogy with Theorem 3.2.7.

Theorem 4.3.6. Let $\mathcal{H}(\lambda; \mathbf{t})$, $\mathcal{F}(\lambda, \mathbf{x})$, and \mathcal{L} be as above. Then

$$e^{\mathcal{L}} \mathcal{F}(\lambda; \mathbf{x})|_{\mathbf{x}=\mathbf{0}} = \mathcal{H}(\lambda; \mathbf{t}) + U, \quad (4.24)$$

where U is a collection of terms coming from moduli stacks where $2g - 2 + \sum a_i \leq 0$.

When defining Hassett spaces in Section 4.1, we noted that $\overline{\mathcal{M}}_{g,\mathcal{A}}$ is a non-empty, smooth, proper DM stack when $2g - 2 + \sum a_i > 0$. The intersection numbers appearing in U correspond instead to Artin stacks instead of DM stacks and occur when one attempts to define moduli spaces of rational curves with weights whose sum is less than or equal to 2. The analogous cases for classical Deligne-Mumford compactifications are moduli stacks of zero-, one-, or two-pointed rational curves. Note that in Theorem 3.2.7 we avoided the need for the unstable terms U by restricting to genus at least one, and we could do the same here.

Remark 4.3.7. In Remark 4.2.6 we noted that Corollary 4.2.5 generalizes in such a way as to explicitly connect two Hassett spaces of $\overline{\mathcal{M}}_{g,\mathcal{B}} \rightarrow \overline{\mathcal{M}}_{g,\mathcal{A}}$, without requiring $\mathcal{B} = 1^n$. In complete analog, the following statement can be seen as a generalization of Theorem 4.3.6, where again the notation becomes far more burdensome.

Define

$$\tilde{\mathcal{L}} := \sum_{b \geq a} t_{a,i} \partial x_{b,i} + \sum_{n \geq 2} \frac{(-1)^{n-1}}{n!} \sum_{\substack{(a_1, i_1), \dots, (a_n, i_n) \\ \sum a_j \leq 1}} t_{a_1, i_1} \cdots t_{a_n, i_n} \partial x_{1, i_1 + \dots + i_n - (n-1)}. \quad (4.25)$$

Then

$$e^{\tilde{\mathcal{L}}} \mathcal{H}(\lambda; \tilde{\mathbf{x}})|_{\tilde{\mathbf{x}}=0} = \mathcal{H}(\lambda; \mathbf{t}) + U. \quad (4.26)$$

4.4 Changes of Variables

There is another way to interpret Theorem 4.3.6 which comes from a standard technique in differential geometry, seen already in Lemma 3.3.1. If we view \mathcal{L} as a vector field, then $e^{\mathcal{L}}$ can be interpreted as flow along that vector field. Thus we have the following lemma.

Lemma 4.4.1. *Rewrite the fork operator as*

$$\mathcal{L} = \sum_{i=0}^{\infty} f_i(\mathbf{t}) \partial x_i = \mathbf{f}(\mathbf{t}) \partial \mathbf{x}. \quad (4.27)$$

Then

$$\begin{aligned}
\mathcal{H}(\lambda; \mathbf{t}) + U &= e^{\mathcal{L}} \mathcal{F}(\lambda; \mathbf{x}) \Big|_{\mathbf{x}=\mathbf{0}} \\
&= \mathcal{F}(\lambda; \mathbf{x} + \mathbf{f}(\mathbf{t})) \Big|_{\mathbf{x}=\mathbf{0}} \\
&= \mathcal{F}(\lambda; \mathbf{f}(\mathbf{t})).
\end{aligned} \tag{4.28}$$

Thus the Hassett potential is a change of variables of the Witten potential. Morally, $e^{\mathcal{L}}$ makes the necessary ψ -class replacements described in Corollary 4.2.5; this also emphasizes why we use both t and x variables in order to clarify which are the "new" and which are the "old" classes.

If we narrow our attention to Hassett spaces of fixed diagonal weights, this change of variables may be made very explicit.

Definition 4.4.2. For q a fixed natural number, the q -**diagonal Hassett potential** $\mathcal{D}_q(\lambda; \mathbf{t})$ is the Hassett potential restricted to weight data of the form $\mathcal{A} = \frac{1}{q}^n$ for any n . Equivalently, $\mathcal{D}_q(\lambda; \mathbf{t})$ is the Hassett potential with all variables not of the form $t_{\frac{1}{q}, k}$ set equal to zero.

The reader may wonder why we do not include potentials with weights such as $\mathcal{A} = \frac{2}{3}^n$. The key impact of the weight data in the diagonal case is how many marked points can simultaneously coincide; thus we need only consider weights of the form $\frac{1}{q}$, where q marked points may come together.

For the sake of clarity and emphasis, we restate some earlier results in the case of the diagonal potentials. Proofs of these statements are essentially identical to their earlier forms with appropriate notation changes; throughout, we assume a fixed $q \in \mathbb{N}$.

Definition 4.4.3. Let $\partial x := \frac{\partial}{\partial x}$. The q -**fork operator** is

$$\mathcal{L}_q := \sum_{n=1}^q \frac{(-1)^{n-1}}{n!} \sum_{i_1, \dots, i_n} t_{\frac{1}{q}, i_1} \cdots t_{\frac{1}{q}, i_n} \partial x_{i_1 + \dots + i_n - (n-1)}. \tag{4.29}$$

Next, a diagonal version of Theorem 4.3.6.

Theorem 4.4.4. *Let $\mathcal{D}_q(\lambda; \mathbf{t})$, $\mathcal{F}(\lambda; \mathbf{x})$, and \mathcal{L}_q be as above. Then*

$$e^{\mathcal{L}_q} \mathcal{F}(\lambda; \mathbf{x})|_{\mathbf{x}=\mathbf{0}} = \mathcal{D}_q(\lambda; \mathbf{t}) + U_q, \quad (4.30)$$

where U_q is a collection of terms coming from moduli stacks where $2g - 2 + \sum \frac{1}{q} \leq 0$.

Finally, the exponential flow for diagonals, mirroring Lemma 4.4.1.

Lemma 4.4.5. *Rewrite the q -fork operator as*

$$\mathcal{L}_q = \sum_{i=0}^{\infty} g_i(\mathbf{t}) \partial x_i = \mathbf{g}(\mathbf{t}) \partial \mathbf{x}. \quad (4.31)$$

Then

$$\begin{aligned} \mathcal{D}_q(\lambda; \mathbf{t}) + U_q &= e^{\mathcal{L}} \mathcal{F}(\lambda; \mathbf{x})|_{\mathbf{x}=\mathbf{0}} \\ &= \mathcal{F}(\lambda; \mathbf{x} + \mathbf{g}(\mathbf{t}))|_{\mathbf{x}=\mathbf{0}} \\ &= \mathcal{F}(\lambda; \mathbf{g}(\mathbf{t})). \end{aligned} \quad (4.32)$$

In this diagonal setting, the change of variables $\mathbf{x} \mapsto \mathbf{g}(\mathbf{t})$ may be made entirely explicit. Note that the following result agrees with that for ω -classes (Corollary 3.3.2) by letting $q \rightarrow \infty$.

Corollary 4.4.6. *The potential $\mathcal{D}_q(\lambda; \mathbf{t})$ is obtained from $\mathcal{F}(\lambda; \mathbf{x})$ via the change of variables given by the following equality of generating functions, where we have denoted $t_k := t_{\frac{1}{q}, 1}$:*

$$\sum_{i=0}^{\infty} x_i z^i = \left[z \left(1 - \exp_q \left(\sum_{k=0}^{\infty} -t_k z^{k-1} \right) \right) \right]_+, \quad (4.33)$$

where \exp_q denotes the truncation of \exp at the q th term and the subscript $+$ denotes the truncation of the expression in brackets to terms with non-negative exponents for the variable z .

Proof. Carefully examining the coefficients of \mathcal{L}_q when written as in (4.31), one obtains

$$\begin{aligned}
 x_0 = g_0(\mathbf{t}) &= t_0 - t_0 t_1 + \frac{t_0^2}{2!} t_2 + t_0 \frac{t_1^2}{2!} - \frac{t_0^3}{3!} t_3 - \frac{t_0^2}{2!} t_1 t_2 - t_0 \frac{t_1^3}{3!} + \dots \\
 x_1 = g_1(\mathbf{t}) &= t_1 - t_0 t_2 - \frac{t_1^2}{2!} + \frac{t_0^2}{2!} t_3 + t_0 t_1 t_2 + \frac{t_1^3}{3!} - \frac{t_0^3}{3!} t_4 - \dots \\
 x_2 = g_2(\mathbf{t}) &= t_2 - t_0 t_3 - t_1 t_2 + \frac{t_0^2}{2!} t_4 + t_0 t_1 t_3 + t_0 \frac{t_2^2}{2!} + \frac{t_1^2}{2!} t_2 - \dots \\
 x_3 = g_3(\mathbf{t}) &= t_3 - t_0 t_4 - t_1 t_3 - \frac{t_2^2}{2!} + \frac{t_0^2}{2!} t_5 + t_0 t_1 t_4 + t_0 t_2 t_3 + \frac{t_1^2}{2!} t_3 + t_1 \frac{t_2^2}{2!} - \dots
 \end{aligned}$$

These sums are finite: only monomials of total degree less than or equal to q appear. It is a simple combinatorial exercise to see that the above change of variables is organized in generating function form as in (4.33). □

Bibliography

- [1] David Mumford. Toward an enumerative geometry of the moduli space of curves. *Arithmetic and Geometry*, 11(36):271–326, 1983.
- [2] Carel Faber and Rahul Pandharipande. Relative maps and tautological classes. *J. Eur. Math. Soc. (JEMS)*, 7(1):13–49, 2005.
- [3] Tom Graber and Rahul Pandharipande. Constructions of nontautological classes on moduli spaces of curves. *Michigan Math Journal*, 51:9, 2003.
- [4] F. Janda, R. Pandharipande, Aaron Pixton, and D. Zvonkine. Double ramification cycles on the moduli spaces of curves. *Publ. Math. IHES*, 125(1):221–266, 2017.
- [5] Renzo Cavalieri and Nicola Tarasca. Classes of weierstrass points on genus 2 curves. *arXiv:1711.00486*, November 2017.
- [6] Johannes Schmitt and Jason van Zelm. Intersections of loci of admissible covers with tautological classes. *arXiv:1808.05817*, 2018.
- [7] Dawei Chen and Nicola Tarasca. Extremality of loci of hyperelliptic curves with marked Weierstrass points. *Algebra & Number Theory*, 10(1):1935–1948, 2016.
- [8] Edward Witten. Two-dimensional gravity and intersection theory on moduli space. *Surveys in differential geometry*, Cambridge, MA, 1990(Lehigh Univ.):243–310, 1991.
- [9] Maxim Kontsevich. Intersection theory on the moduli space of curves and the matrix airy function. *Communications in Mathematical Physics*, 147(1):1–23, 1992.
- [10] Ib Madsen and Michael Weiss. The stable moduli space of Riemann surfaces: Mumford’s conjecture. *Annals of Mathematics*, 165(3):843–941, 2007.
- [11] Rahul Pandharipande. The kappa ring of the moduli of curves of compact type. *Acta Math*, 208:335–388, 2012.

- [12] Rahul Pandharipande. A calculus for the moduli space of curves. *Algebraic geometry: Salt Lake City 2015, Proc. Sympos. Pure Math*, 97:459–487, 2018.
- [13] Brendan Hassett. Moduli spaces of weighted pointed stable curves. *Advances in Mathematics*, 173(2):316–352, 2003.
- [14] Stephanie Yang. Intersection numbers on $\overline{\mathcal{M}}_{g,n}$. *Journal of Software for Algebra and Geometry*, 2(1):1–5, 2010.
- [15] Joachim Kock. Notes on psi classes. *Notes*, 2001. <http://mat.uab.es/kock/GW/notes/psi-notes.pdf>.
- [16] Enrico Arbarello and Maurizio Cornalba. Combinatorial and algebro-geometric cohomology classes on the moduli space of curves. *Journal of Algebraic Geometry*, 5(4):705–749, 1996.
- [17] Vance Blankers and Renzo Cavalieri. Intersections of ω classes in $\overline{\mathcal{M}}_{g,n}$. *Proceedings of Gökova Geometry–Topology Conference 2017*, pages 37–52, July 2018.
- [18] Stephanie Yang. Calculating intersection numbers on moduli spaces of curves. *Preprint*, arXiv:0808.1974v2, 2010.
- [19] Dawei Chen and Izzet Coskun. Extremal higher codimension cycles on moduli spaces of curves. *Proc. London Math. Soc.*, 111(1):181–204, 2015.
- [20] Dawei Chen and Izzet Coskun. Extremal effective divisors on $\overline{\mathcal{M}}_{1,n}$. *Math. Ann.*, 359(3-4):891–908, 2014.
- [21] William Frederick Rulla. *The birational geometry of moduli space $M(3)$ and moduli space $M(2,1)$* . PhD thesis, University of Texas at Austin, 2001.
- [22] Joe Harris and David Mumford. On the Kodaira dimension of the moduli space of curves. *Invent. Math.*, 67:23–88, 1982.

- [23] Dan Abramovich, Alessio Corti, and Angelo Vistoli. Twisted bundles and admissible covers. *Comm. in Algebra*, 31(8):3547–3618, 2001.
- [24] Renzo Cavalieri. Hodge-type integrals on moduli spaces of admissible covers. *Geom. Topol. Monogr.*, 8:167–194, 2006.
- [25] Ana-Maria Castravet and Jenia Tevelev. $\overline{M}_{0,n}$ is not a Mori dream space. *Duke Math. J.*, 164(8):3851–3878, 2015.
- [26] José Luis González and Kalle Karu. Some non-finitely generated Cox rings. *Compos. Math.*, 152(5):984–996, 2016.
- [27] Juergen Hausen, Simon Keicher, and Antonio Laface. On blowing up the weighted projective plane. *ArXiv e-prints*, August 2016.
- [28] Scott Mullane. On the effective cone of $\overline{M}_{g,n}$. *arXiv:1701.05893*, January 2017.
- [29] Morgan Opie. Extremal divisors on moduli spaces of rational curves with marked points. *Michigan Math. J.*, 65(2):251–285, 2016.
- [30] Adam Logan. The Kodaira dimension of moduli spaces of curves with marked points. *Amer. J. Math.*, 125(1):105–138, 2003.
- [31] Renzo Cavalieri. Hurwitz theory and the double ramification cycle. *Jpn. J. Math.*, 11(2):305–331, 2016.
- [32] Carel Faber. MAPLE program for computing hodge integrals. Available at <http://math.stanford.edu/~vakil/programs>.
- [33] Seán Keel. Basepoint freeness for nef and big line bundles in positive characteristic. *Ann. of Math.*, 149(1):253–286, 1999.
- [34] Valery Alexeev and G. Michael Guy. Moduli of weighted stable maps and their gravitational descendants. *Journal of the Institute of Mathematics of Jussieu*, 7(3):425–456, 2008. MR 2427420.

- [35] Yuri I Manin and Peter Zograf. Invertible cohomological field theories and weil-petersson volumes. *Annales de l'institut Fourier*, 50(2):519–535, 2000.
- [36] F. Faa di Bruno. Sullo sviluppo delle funzioni. *Annali de Scienze Matematiche e Fisiche*, 1855.
- [37] L. F. A. Arbogast. Du calcul des derivations. *Strasbourg: Levrault*, 1855.
- [38] Eric Temple Bell. Partition polynomials. *Annals of Mathematics*, 29(1-4):38–46, 1927-1928.