

TA7

CL

CER 53-7

Reading Room

COPY 2

Final Report

on the

DESIGN OF THE LOUP RIVER BED-LOAD MEASUREMENT STRUCTURE

prepared for

The United States Geological Survey

by

(M. L. ALBERTSON)

The Civil Engineering Section

of the

Colorado Agricultural Experiment Station

Fort Collins, Colorado

ENGINEERING RESEARCH

JUL 26 '71

FOOTHILLS READING ROOM

July, 1948

CER 53MLA7

Final Report

on the

DESIGN OF THE LOUP RIVER BED-LOAD MEASUREMENT STRUCTURE

prepared for

The United States Geological Survey

by

The Civil Engineering Section

of the

Colorado Agricultural Experiment Station

Fort Collins, Colorado

July, 1948



U18401 0589789

TABLE OF CONTENTS

	Page
Introduction and Statement of the Problem.....	1
Possible Solutions of the Problem.....	2
Theoretical and Dimensional Analysis of the Problem.....	4
Experimental Equipment.....	6
Experimental Results.....	7
Recommended Design of the Structure.....	11
Personnel.....	14
Acknowledgements.....	15

LOUP RIVER BED LOAD MEASUREMENT STRUCTURE

Introduction and Statement of the Problem

For many years there has been a need for an accurate determination of the quantity of bed load of sediment in rivers and canals. This need finally precipitated joint action on the part of the Quality of Water Branch of the United States Geological Survey and the United States Bureau of Reclamation. The Middle Loup River in Nebraska, a relatively small stream known to have a large bed load concentration, was selected in which to build a structure that would enable measurement of the total quantity of sediment transported. The United States Geological Survey contracted with the Experiment Station of Colorado A and M College to prepare designs based upon model studies made in the hydraulics laboratory.

The highway bridge at Dunning, Nebraska was chosen as the site for the structure. Although the size of the watershed is approximately 1350 square miles as determined from topographic maps, the area actually contributing to surface runoff is only 93 square miles. The entire watershed is in sand-hill country so that most of the stream flow comes from ground water. As a result, the maximum instantaneous runoff on record is only 821 cubic feet per second and the minimum is 220 cubic feet per second. It is logical, then, for visual observation to indicate that most of the sediment load originates from the caving of the banks of the stream.

Because the bed material of the stream is essentially the same size as the material in suspension, (see Fig. 1), there is considerable fluctuation of bed elevation. As a result, a stable rating curve of water discharge is impossible to obtain (see Fig. 2). Likewise the variation of suspended load concentration with discharge is very difficult to estimate even with the measurements that have been taken.

The installation of a structure in the river will naturally cause backwater upstream from it. In order to hold to a minimum any damage to adjacent lands, it was decided, after several conferences with representatives of the sponsoring organizations, to limit the increase in surface level upstream from the structure to 1.5 feet at 250 cubic feet per second, and to 1.0 feet at 821 cubic feet per second. It was also decided that the structure should permit, if possible, a measurement of 2000 parts per million of total sediment.

Possible Solutions of the Problem

The two possible general methods that may be used for measuring the discharge of bed load are: (1) to trap the bed load over a given period of time and measure it volumetrically or by weighing, and (2) to force the bed load into suspension so that it may be measured with standard suspended load samplers.

Although there are a number of ways of trapping the bed load, each involves special equipment that must be placed below the level of the river bed. Furthermore, any system that is not operated continuously upsets the equilibrium of the stream, and some length

of time is required before equilibrium is again established and a measurement made.

To force the bed load into suspension it is necessary to cause additional turbulence in the stream. This turbulent energy may come from some external source or from the river itself. Two possible external sources are pumps supplying jets of water or compressors supplying jets of air. These jets most probably should be located on the river bed immediately upstream from the measuring section, their purpose being to supply turbulence to the stream. Aside from the fact that the jets would continually be subject to plugging and other difficulties of operation, they also would upset the equilibrium of bed load movement and require an unknown amount of time for equilibrium to be reestablished.

The energy of the stream itself may also be used to create the turbulence necessary to place the bed load in suspension. Such energy, however, will eventually be dissipated and cannot be recovered. Hence, there will be a backwater effect upstream from any turbulence-producing structure. It is apparent, then, that model studies must be made to determine whether the head losses through the proposed structure are within those allowable. Because the greatest turbulence is needed near the bed of the stream to pick up the bed load, it is logical to use roughnesses on the bed itself to create the turbulence.

After consideration of the methods discussed above, it was decided that the method of using the energy of the stream was the most practical and should be investigated first. The other possibilities, trapping the bed load and using jets, not only involve equipment

difficult to maintain and operate, but also upset the equilibrium of the stream at the time of measurement since operation is not continuous. Therefore, the remainder of the report involves the analysis and design of a structure using roughnesses on the bed of the stream.

Theoretical and Dimensional Analysis of the Problem

A boundary roughness to be used for the particular installation in question must be simple to construct, low in cost, and easy to install. For this reason rectangular baffle plates placed perpendicular to the stream were chosen.

Because the energy that is lost through the structure is first converted into turbulence, it is reasonable to expect that the arrangement and design of the baffles which creates the greatest loss will probably produce the greatest turbulence for suspension of bed load. Therefore, theoretical and experimental studies are needed to determine the conditions necessary for maximum head loss.

Dimensional analysis of the problem of head loss involves the height of the baffles h , their width b , the longitudinal spacing s , and the lateral spacing x (see Fig. 3). The geometry of the flow also includes a characteristic depth d , and head loss ΔH . Additional important variables are the characteristic velocity V and the fluid properties density ρ , viscosity μ , and the difference in the specific weights of water and air $\Delta \gamma$. These variables may be expressed in the general functional form

$$f_1 (h, b, s, x, d, \Delta H, V, \rho, \mu, \Delta \gamma) = 0 \quad (1)$$

Dimensional analysis then reduces this function to

$$\Delta H/h = f_2 \left(d/h, b/h, s/h, x/h, \frac{V}{\sqrt{\Delta \gamma / \rho d}}, \frac{Vd\rho}{\mu} \right) \quad (2)$$

the last two variables being the familiar Froude Number F and Reynolds Number R . Obviously, to make a study of Eq. 2 would be very lengthy because it involves seven variables. Therefore, it is necessary to omit some of them and to hold others constant.

In the studies of flow in open channels, the viscous effects (a function of Reynolds Number) are relatively unimportant if the roughness is several times as great as the thickness of the laminar sublayer. Because the roughness required to produce the necessary turbulence in this particular study is so large, there is little question that its effective height is many times the thickness of the laminar sublayer and that the Reynolds Number may therefore be neglected. Furthermore, if the Froude Number and the baffle height are held constant for a given discharge, then F and d/h do not enter as variables, and Eq. 2 may be simplified to

$$\Delta H/h = f_3 (b/h, s/h, x/h) \quad (3)$$

It must be remembered that the above analysis involves only the head loss resulting from various shapes and arrangements of baffles perpendicular to the flow, neglecting completely any consideration of sediment.

Once the optimum shape and arrangement of baffles is determined, however, it is possible to more easily analyze the capacity of the

flow to force a sediment of given size and quantity into suspension. Additional variables necessary to describe the sediment are the mean settling velocity ω and the density ρ_s of the sediment, the standard deviation of the settling velocity σ of the sediment, and the concentration of the sediment C .

Combining these with Eq. 2 yields

$$C = f_4 (d/h, b/h, s/h, x/h, F, R, \omega/V, \sigma/V, \rho_s/\rho) \quad (4)$$

the head loss in Eq. (2) being replaced by the concentration as a dependent variable.

Again the Reynolds Number is assumed negligible, due to the extreme size of the roughness, and F and d/h are held constant. Furthermore, by using sand of the same density as that in the Loup River ρ_s/ρ is held constant. The ratio σ/V is neglected because of its relative insignificance and the difficulty in controlling it. Finally, Eq. (4) is simplified to

$$C = f_5 (b/h, s/h, x/h, \omega/V) \quad (5)$$

an expression stating the capacity of a given roughness arrangement to place in suspension sand having a fall velocity ω .

Experimental Equipment

To carry out the model studies necessary for the testing of various designs, a flume, see Figs. 4a, 4b, 4c, & 4d, was built with a 2-foot test section. The incoming water entered a stilling basin 4 feet wide, passed through a rock baffle, and was contracted

vertically. The horizontal contraction from 4 feet to 2 feet was immediately upstream from the test section to prevent as much as possible the formation of a boundary layer on the vertical sides.

To control the depth of the water in the test section for a given discharge, a series of movable slats were placed at the downstream end. From the test section the water entered a weir box which also was used as a stilling basin and sand trap. A lattice with 1-inch square bars spaced on $2\frac{1}{2}$ -inch centers quieted the water plunging into the weir box from the test section. The weir was calibrated by weighing the discharge.

The basic foundation of the model, see Fig. 5, was made of exterior plywood and white pine. A special measuring sill and end sill were placed at the downstream end. Thumb tacks were used for speed and ease in fastening the roughnesses, made of 20-gage galvanized metal, to the foundation. See Figs. 6 and 7 for the arrangements of these baffles.

Introduction of sand at a constant rate was accomplished, after much experimentation, by means of a reciprocating plate moving at the base of the hopper. On the side of the hopper was mounted a vibrator to keep the sand in a kind of "plastic" state, thereby permitting the sand to flow freely, see Fig. 8a and Fig. 8b. The relative position of the model and the sand-feed mechanism is shown in Fig. 9.

Experimental Results

In order to keep the Froude Number in the model the same as that in the prototype, it was necessary first to make an estimate of

the variation of discharge with depth of flow at the Loup River bridge for Highway No. 2. This estimate, see Fig. 10, was based upon the rating curve, see Fig. 2, established for the rating station approximately one mile upstream from the bridge. Two curves were plotted, one of the probable maximum discharge and another of the probable minimum discharge for a given depth. An average curve was used in the model studies.

In addition to the Froude Number, the velocity ratio w/V must be kept a constant from model to prototype if dynamic similarity is to be attained. Unfortunately, however, maintaining a constant velocity ratio is difficult to do because of the small size of sediment required for the model. The following table gives this ratio for the prototype and the model:

Ratio w/V of the Mean Fall Velocity of the Sediment to the Velocity of Flow in the River

Discharge	Prototype	Model
200	0.098	0.16
400	0.072	0.12
800	0.051	0.084
1200	0.042	0.070

It was not possible to obtain sufficient quantities of sand small enough to make the ratio a constant. The deviation, however, is in the direction of safety because if it is possible to place in suspension sand of a given fall velocity it will certainly be possible to place in suspension the same concentration of a smaller sand having a lower fall velocity.

The sand used in the model studies is a wind-blown sand obtained near Fort Collins. It was passed through a 30-mesh screen and then washed. The size analysis before and after washing is shown in Fig. 11.

Tests made prior to the writing of the Preliminary Report of May 13, 1948, demonstrated that it would not be possible to obtain a sufficiently high velocity through the structure without raising the floor above that of the streambed. In fact, it was found necessary to approach critical velocity over the measuring section for all discharges. Likewise, preliminary experiments indicated that a model-prototype ratio of 1 to 8 was somewhat small. It was therefore decided to continue the remainder of the experiments with a scale ratio of 1 to 4.

Because of the limited time available, it was not possible to make a completely generalized determination of the effect of roughness size and spacing upon the head loss. Instead, two values $x/h = 0$ and $x/h = 2$ were chosen and head-loss measurements made over a wide range of s/h for discharges of 400 CFS and 800 CFS. The height h of the baffles was kept constant at 6 inches. Fig. 12 shows the results.

When $x/h = 0$ the maximum head loss occurs approximately at a longitudinal spacing of $s/h = 10$. This value, incidentally, is the same as that found by other experimenters using square battens across the flow. For another series of experiments b/h and x/h were held constant at a value of 1.0 and 2.0 respectively. These show that the longitudinal spacing s/h must be reduced to an approximate value of 2.0 in order to obtain the maximum head loss. It may be assumed from

these data that the lower the value of x/h the greater will be the maximum head loss.

Unfortunately, however, at the first baffle the flow does not have enough turbulence to force into suspension all of the bed load. The turbulence gradually increases as the flow passes each additional baffle until, at the baffle immediately upstream from measuring sill, it is sufficient to carry the entire sediment load in suspension. For this reason it is not possible to use a continuous baffle ($x/h = 0$) but rather it is necessary to have individual baffles with lateral spacing between them through which the residual bed load may pass. Experiments demonstrate this reasoning to be correct - a sand bar moves downstream covering in turn each continuous baffle.

In order to allow space for movement of bed load between baffles, it was decided to have $x = 4$ feet, $b = 2$ feet, and $s = 2$ feet. It was hoped that a baffle height of 6 inches would be sufficient to place 2000 ppm in suspension but these baffles were almost completely covered by dunes, see Figs. 13, 14, 15, 16, 17 and 18. Baffles of one foot height, however, remained relatively clean except at the upstream end, and there was no tendency for bed load movement across the measuring sill, see Figs. 19, 20, 21, 22, 23, and 24. All runs were made over a sufficient period of time (from 30 minutes to 2 hours) to adequately reach equilibrium. Measurements and photographs also were taken for an arrangement of 18-inch baffles in the two upstream rows, see Figs. 25, 26, 27, 28, 29, and 30. This arrangement materially increased the turbulence, and the upstream baffles remained completely clean.

Both of the latter two arrangements were found to be satisfactory with a total sediment concentration of 2000 ppm. The head loss for each case is listed in the following table:

Head Losses for Various Discharges and Baffle Arrangements

Baffle Arrangement	Discharge		
	250 CFS	400 CFS	800 CFS
All Baffles 6" High	0.728	0.188	0.212
All Baffles 12" High	0.816	0.476	0.332
Two Upstream Rows 18" High, Remainder 12" High	0.864	0.528	0.424

It will be noted that a discharge of 800 CFS with 6" baffles does not give the expected minimum loss. This is due to the occurrence of the irregular pattern of sand deposit which increases the roughness of the bed. At times the sand dunes would completely cover the measuring sill and at other times (shown in the photograph) the sill would be free of deposit. Although 800 CFS resulted in an unstable pattern, the two lower flows caused a stable deposit that completely covered the measuring sill at 400 CFS and covered all but the final continuous baffle and the measuring sill at 250 CFS.

Recommended Design of the Structure

Based upon the foregoing research it is recommended that 9 rows of baffles one foot high and 2 feet long be used with a lateral spacing of 6 feet and a longitudinal spacing of 2 feet from center to center. These baffles create the turbulence necessary to force the bed load into suspension. In addition, a continuous baffle 6 inches high is placed 32 inches down stream from the last row of one-foot baffles,

and 26 inches upstream from the measuring sill. This baffle contributes toward making the sediment distribution uniform along the measuring sill. Because of the probable inaccuracy of the estimation of the rating curve and the concentration of total load of sediment in the river, and because the velocity ratio was not the same in the model as in the prototype, it is possible that information beyond that available at the time of this report may indicate a more efficient arrangement. For this reason the baffles are designed so that they may be changed easily and quickly.

It is planned that measurements will be taken at the downstream edge of the measuring sill, see Figs. 31 and 32. Although it is recommended that the sill have a rectangular cross section 6 inches high and 16 inches wide, the width may be increased and the upstream side streamlined without materially reducing its effectiveness. It must be remembered, however, that the wider and the more streamlined the measuring sill the less turbulent the water at the point of measurement.

At the downstream side of the structure is the end sill which is intended to serve two purposes. First, it serves to give the lower part of the water an upward component of velocity as it leaves the sill, thereby causing a reverse eddy at the downstream face of the structure. This eddy prevents undermining and exposure of the sheet piling. Second, the end sill creates a pool between itself and the measuring sill so that waves in the region of measurement are held to a minimum.

At both the upstream and the downstream sides of the structure, steel interlocking sheet piling is to be driven to a depth of at least

15 feet. This is also to be carried into the stream banks as far as the existing wing walls for the bridge. It is recommended that it be 8 gage or heavier. The uppermost 18 inches of all the sheet piling is to be encased in a reinforced concrete cap 20 inches wide and 30 inches deep, see Fig. 33. Welded to the piling at longitudinal and vertical intervals of 12 inches and 6 inches respectively, are 8-inch bars with 2-inch legs. U-bars at a longitudinal spacing of 12 inches and longitudinal bars at 6-inch intervals are required as shown in Fig. 33.

The timber piling for the bents and abutments of the existing bridge are to be encased in concrete from the lower side of the present cap to a depth of 30 inches below the upper surface of the floor slab. The reinforcing steel composed of 1/8-inch by 3-inch wire mesh is for temperature stresses only. At 24-inch vertical intervals, 4 lag bolts, 1/2 inch by 8 inches, are screwed 4 inches into the timber piling to integrate the concrete and the wood.

To insure the safety of the structure, the concrete floor slabs are designed as units separate from the sheet piling caps and the timber piling casing. In order to seal the 2-inch construction joint, a lead sheet is placed in them at the time the concrete is poured. Asphalt in the joints above and below the lead sheet protects it from filling with sand. It is recommended that the caps for the steel piling and the casings for the timber piling be placed as a first step.

The steel in the floor slab is also intended for temperature stresses only. It is believed that piping of the sand from under the

slab will be so minor, if at all, that no significant beam action will result.

As previously mentioned, the baffles are designed so that they may be quickly removed from the floor slab. This is accomplished by means of two $1/2''$ bars inclined upstream at an angle of 15° with the vertical and placed in the concrete at the time the floor slab is poured. The bars are 8 inches long with 2 inches protruding above the floor. In the horizontal leg of the baffle angle are two holes through which the bars extend thereby anchoring the baffle. To the angle is bolted a vertical plate of the desired size. The size recommended is 12 inches high by 2 feet wide by $1/4$ -inch thick if it is made of aluminum or by $3/16$ -inch thick if it is made of steel.

Behind the upstream wing wall on the south side of the bridge is the gage house placed one foot from the outside edge of the shoulder of the highway. It is to be of standard design with two 3-inch intake pipes, the lower one 4 inches and the upper one 15 inches above the floor slab.

Personnel

Dean N. A. Christensen, Professor Robert L. Lewis, and Professor Hubert W. Collins gave many helpful suggestions in regard both to research and design. Professor Maxwell Parshall was responsible for the photographs and gave other valuable assistance. Undergraduate students Mr. Don Matejka and Mr. Chester Hallmark and graduate students Mr. King Yu and Mr. Lucien Hirschberg helped prepare the models, take the data, and make the drawings.

Prior to his departure after the preliminary report, Mr. Pavel Novak made major contributions in regard both to design and research. The entire investigation was under the direct supervision of Professor Maurice L. Albertson.

Acknowledgements

Throughout the period of this study, various representatives of the U. S. Geological Survey and the Bureau of Reclamation were frequently consulted so that the final design would most nearly fit their needs. Special acknowledgement is due Mr. Paul Benedict and Mr. Eugene Serr of the U. S. Geological Survey and to Mr. E. W. Lane, Mr. Thomas Maddock, Mr. Whitney Borland, and Mr. Victor Koelzer of the Bureau of Reclamation. Visits were also made by Mr. Clifford Boyer and Mr. Donald Culbertson of the Geological Survey.

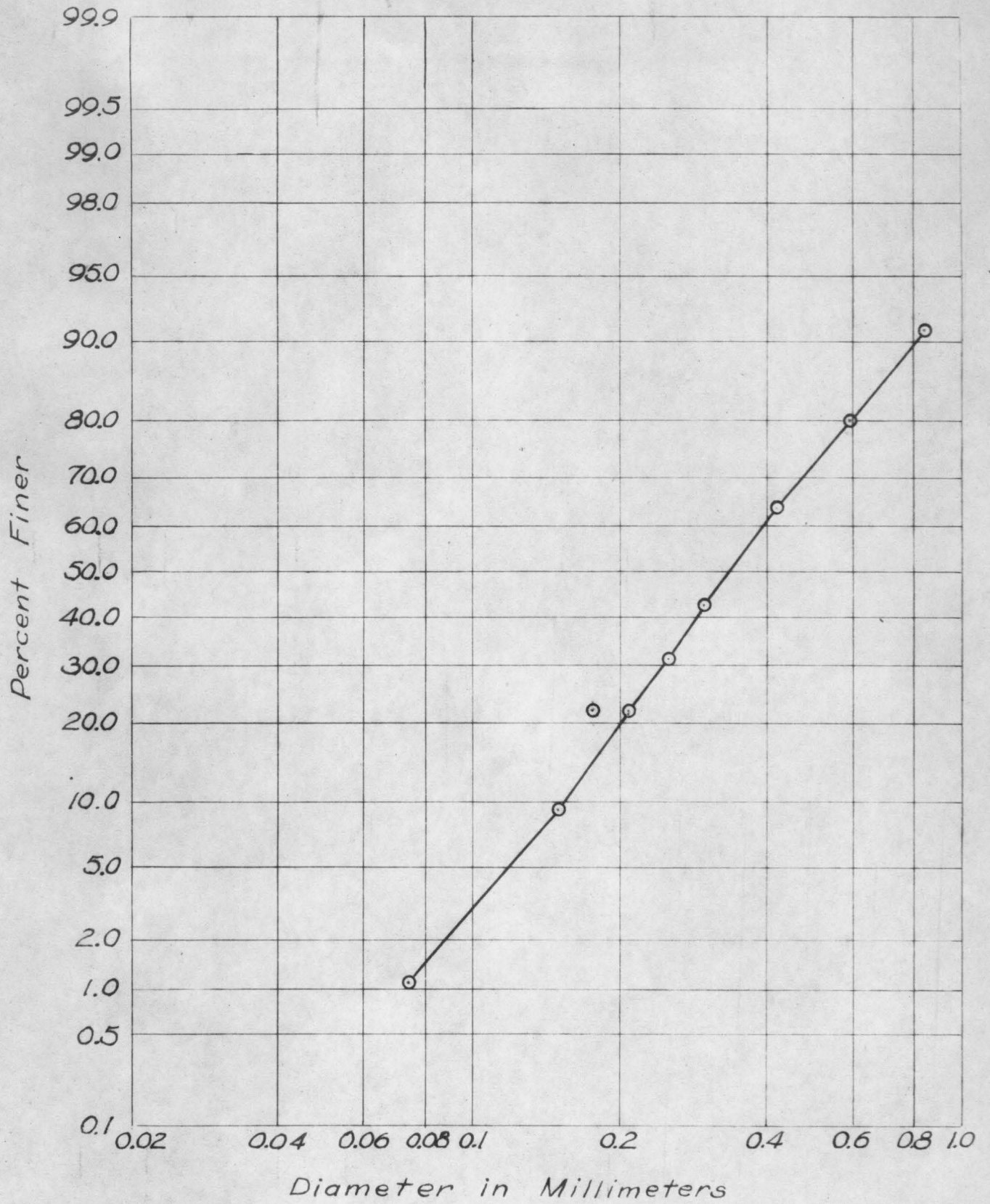

Fig. 1 Sieve Analysis of Sand from Loup River

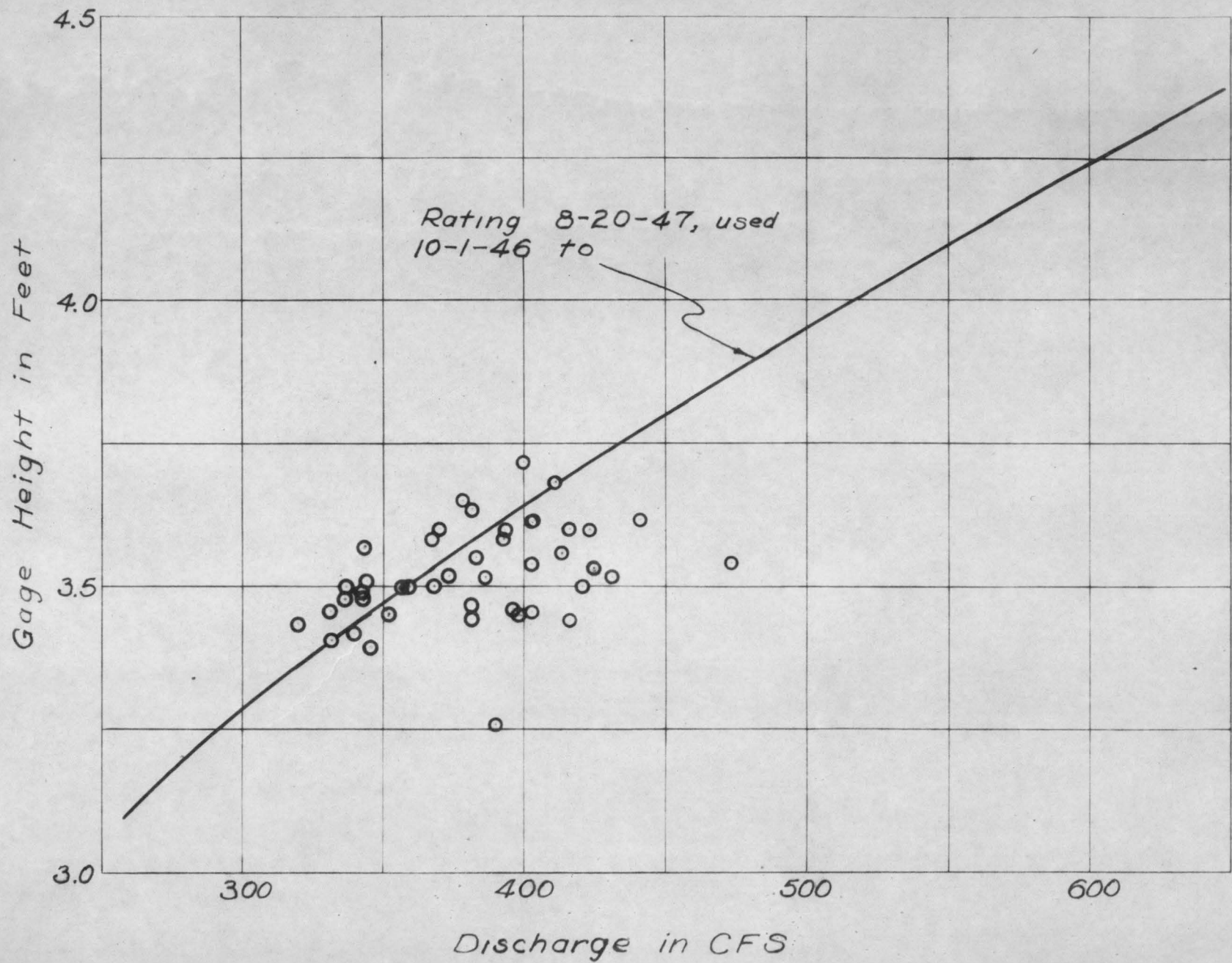

Fig. 2 Rating Curve for Middle Loup River at Dunning, Nebr.

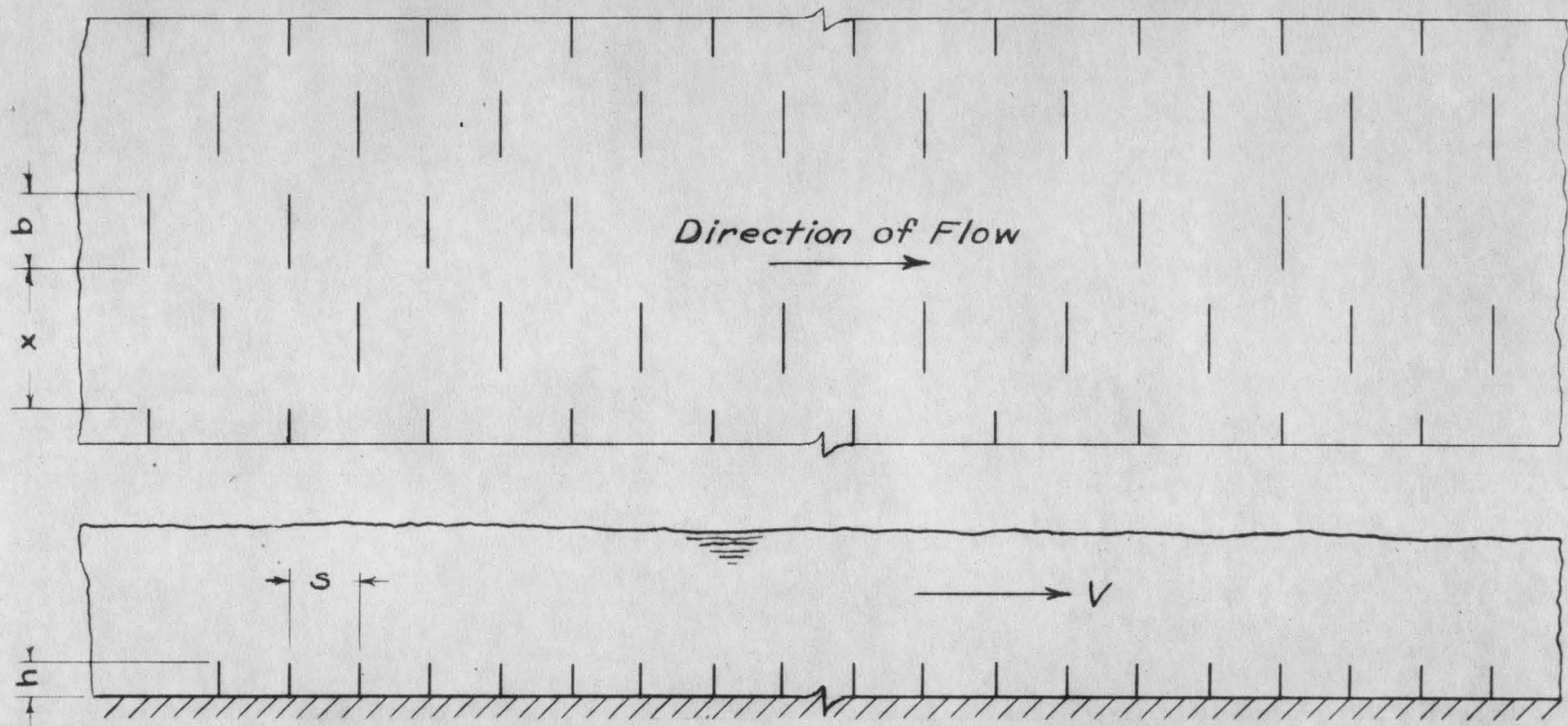
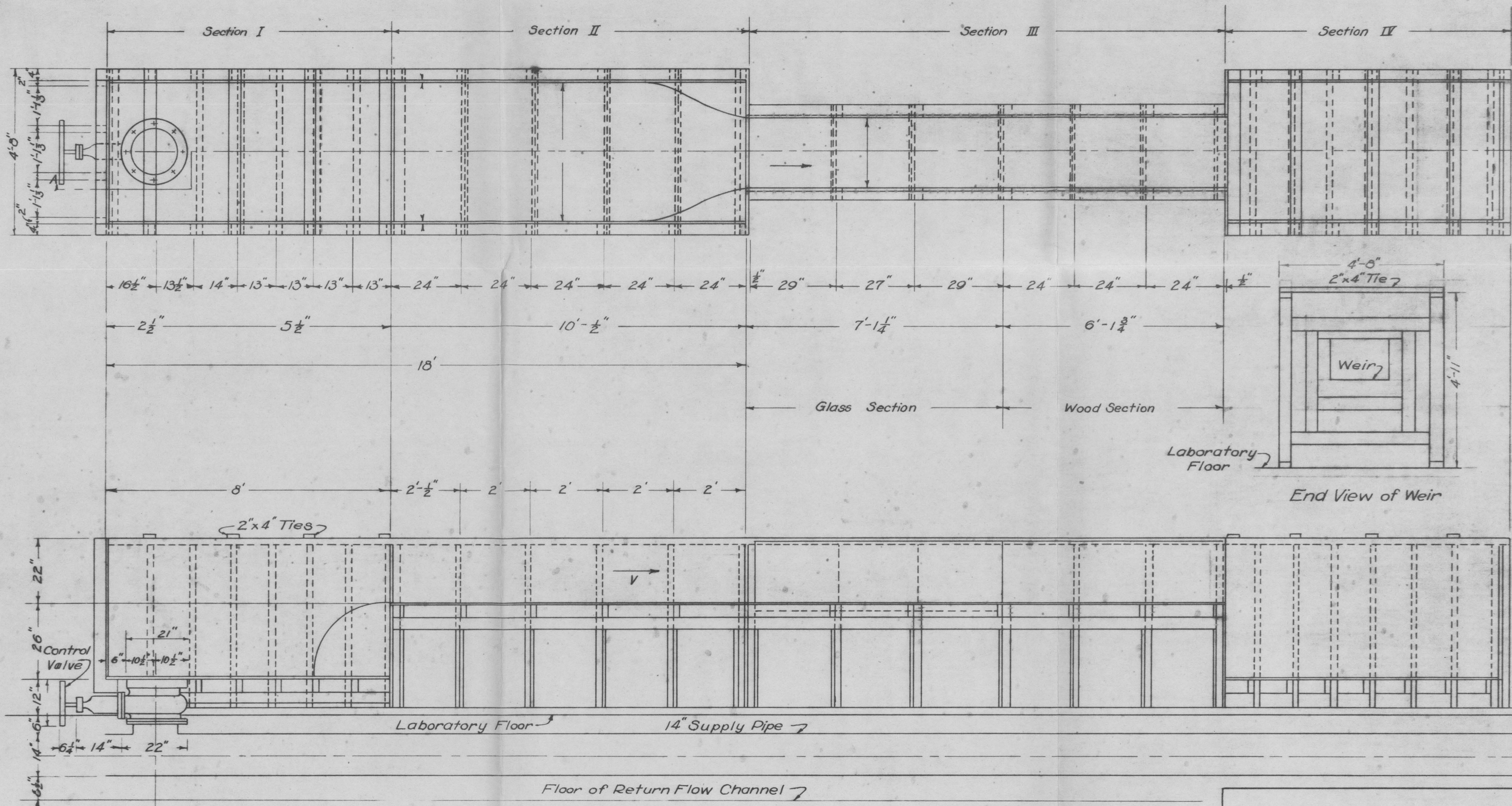
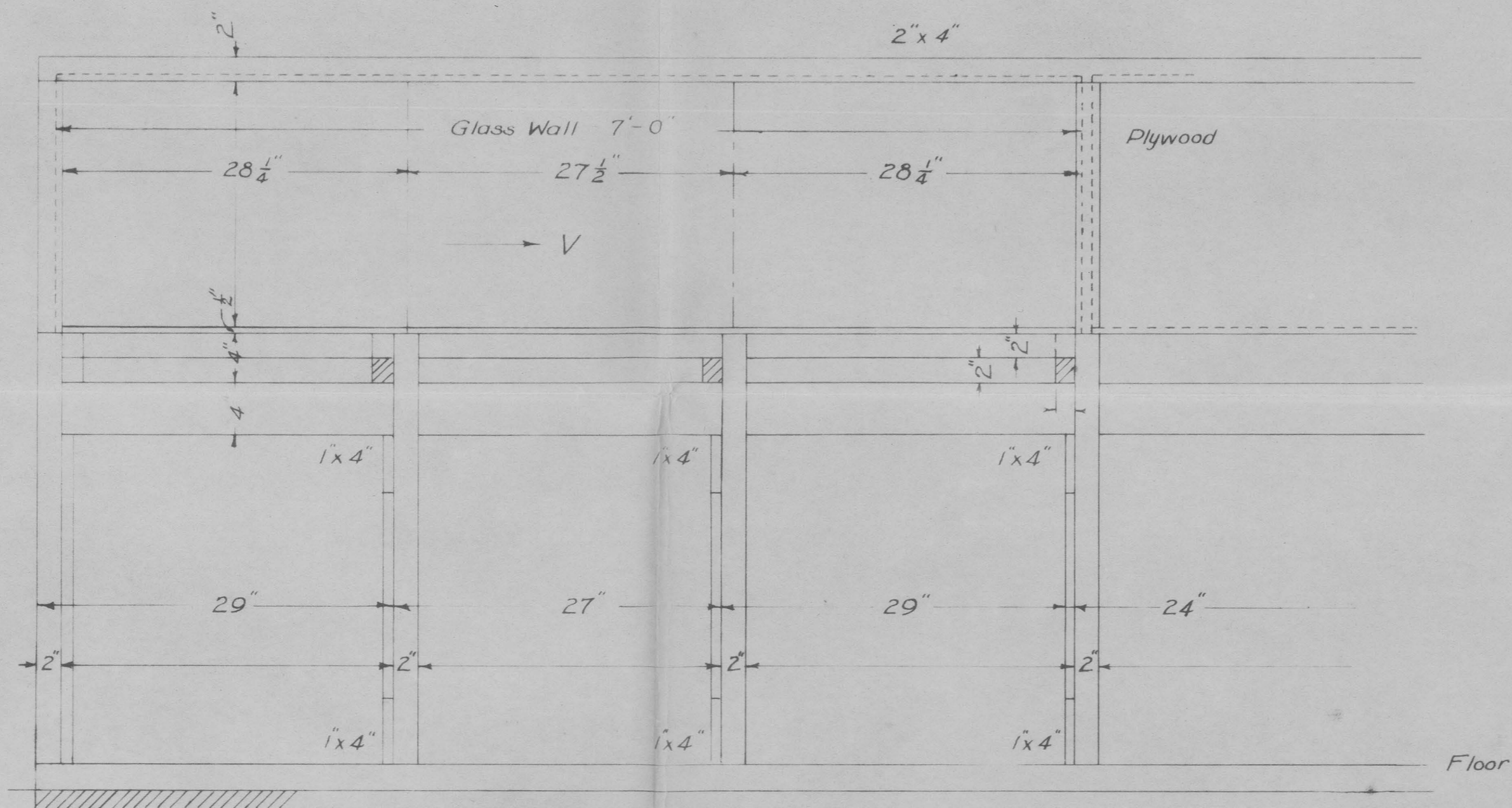

Fig. 3 Schematic Representation of Roughness



Section A-A

Fig. 4a Flume Used for Model Studies



Elevation

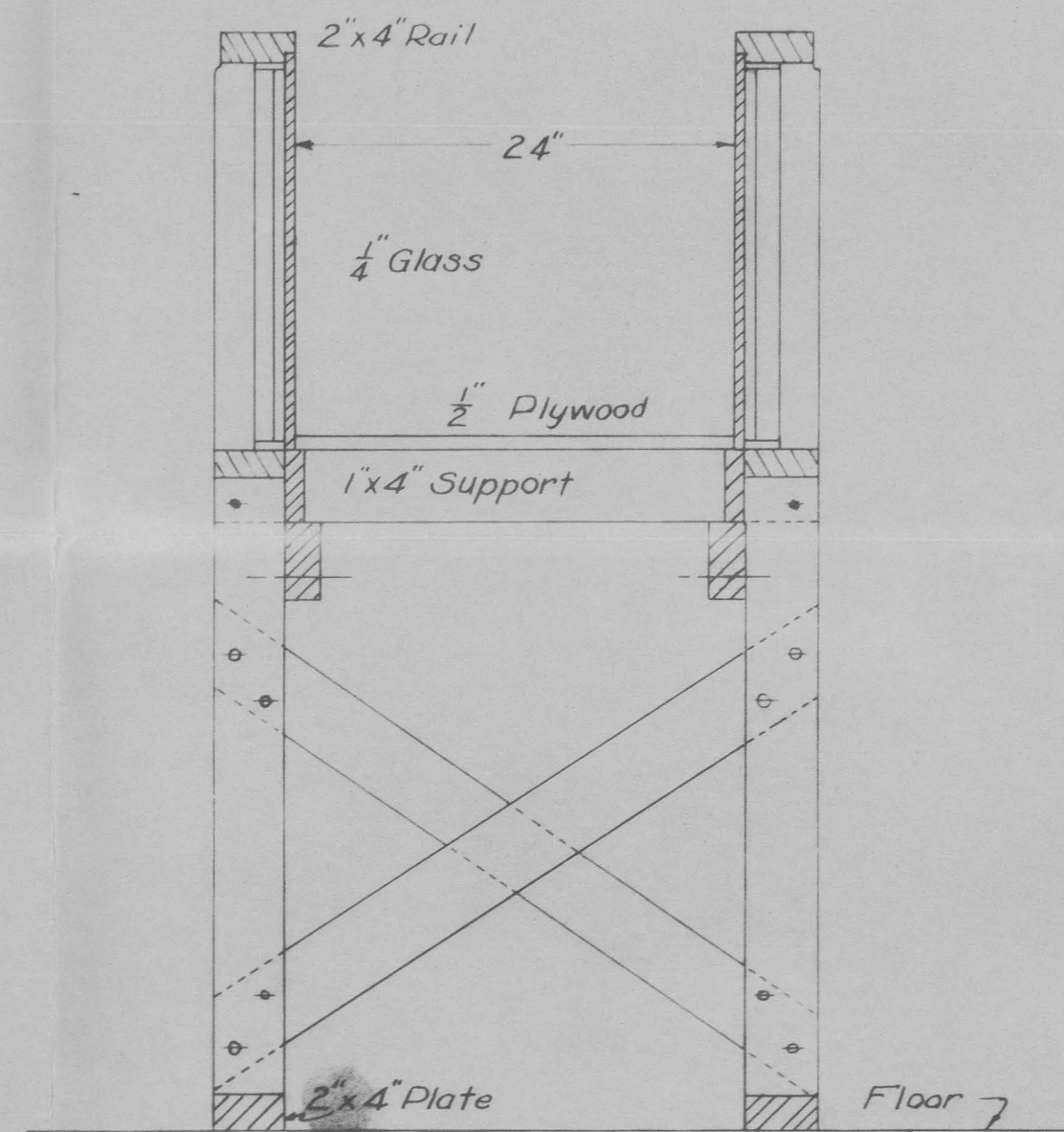

Sectional End View

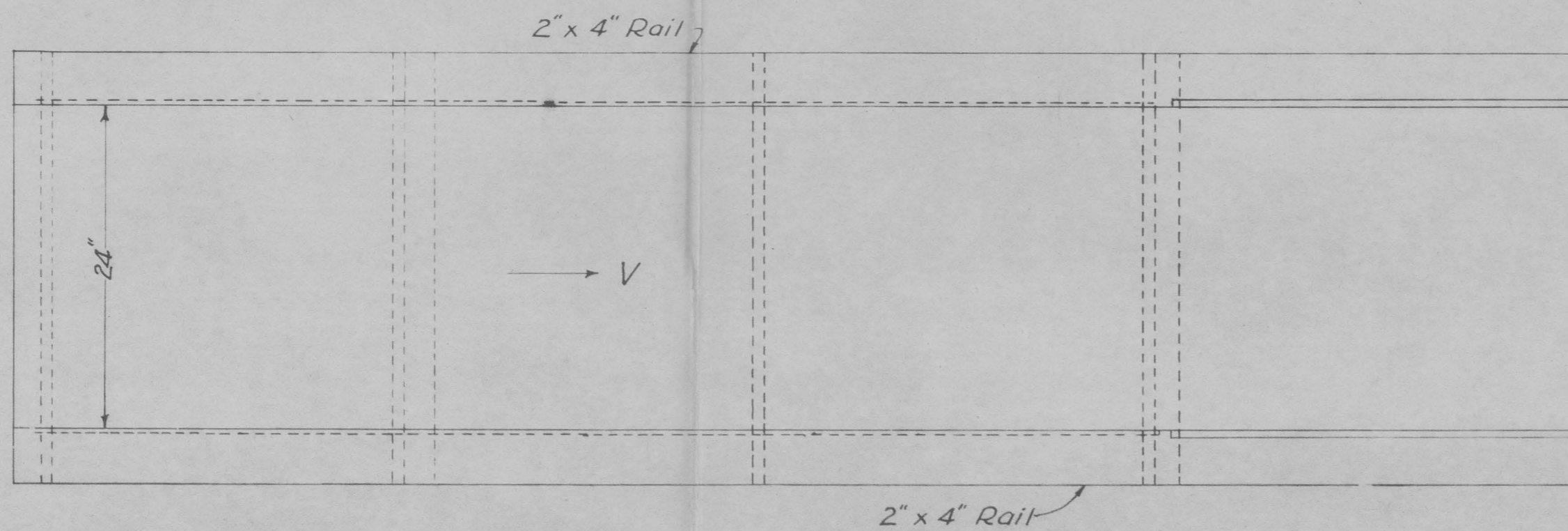

Plan

Fig. 4b Glass-Walled Section

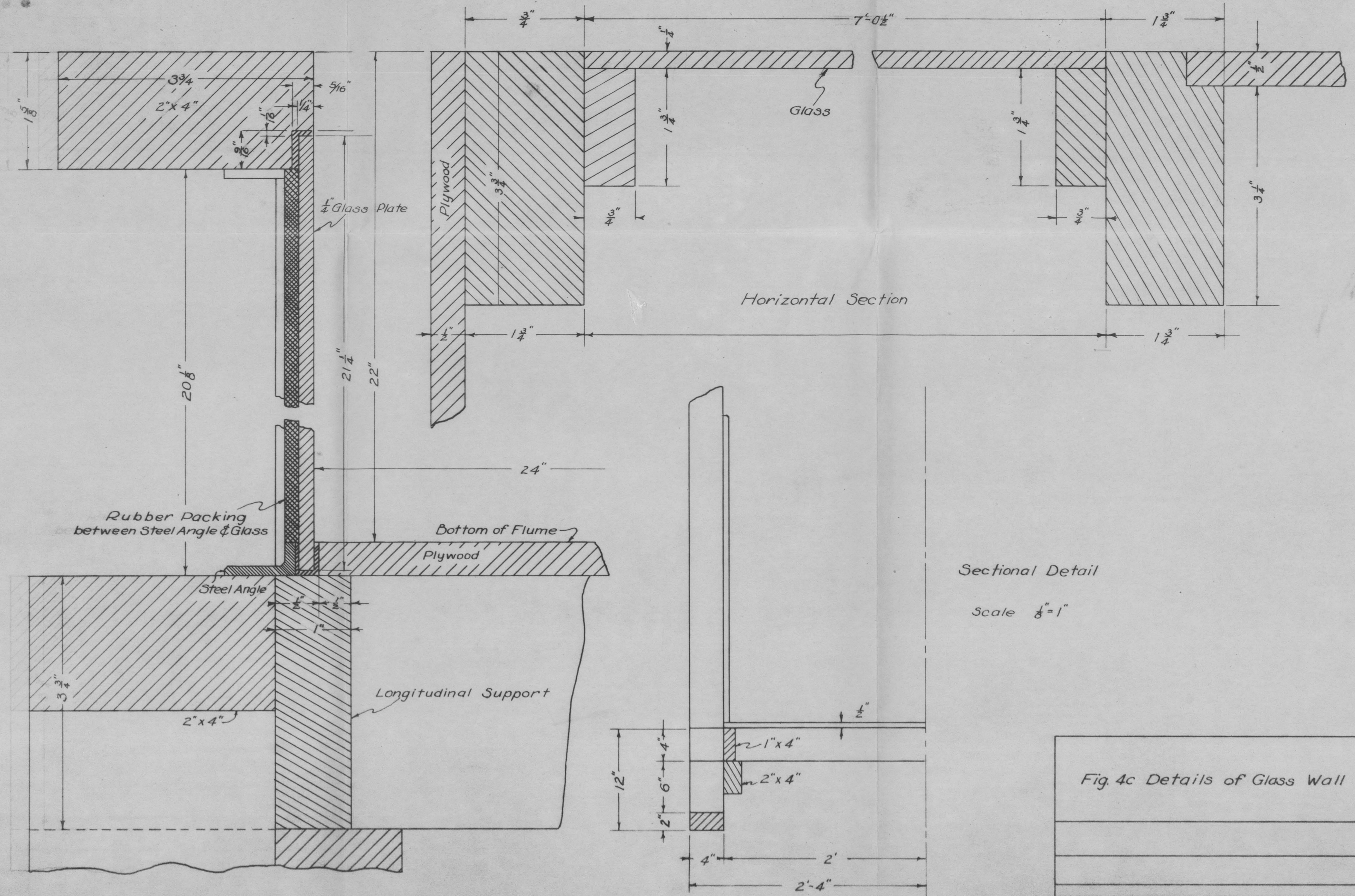

Fig. 4c Details of Glass Wall

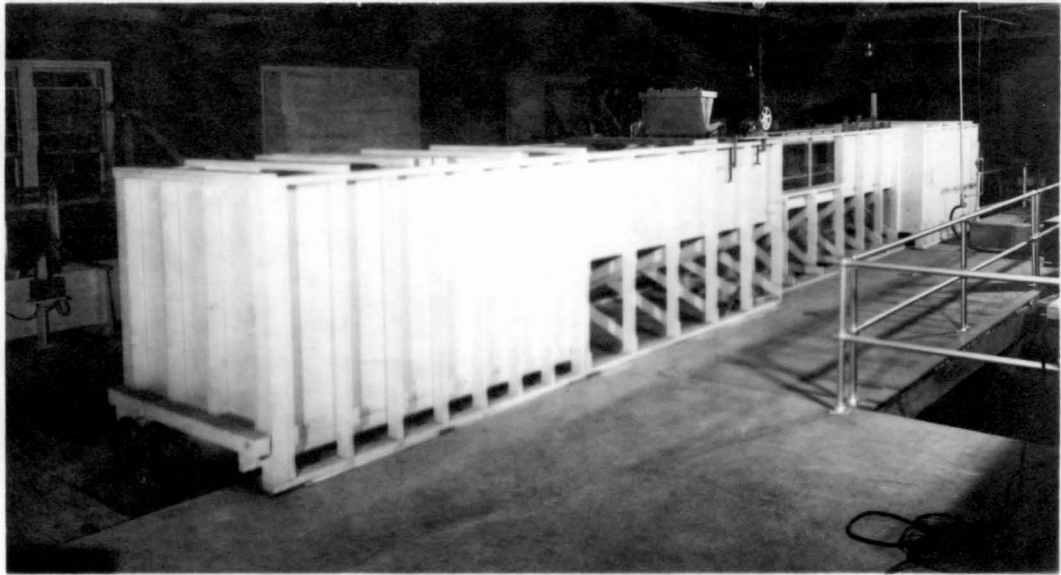

Fig. 4d General View of Flume used for Model Studies

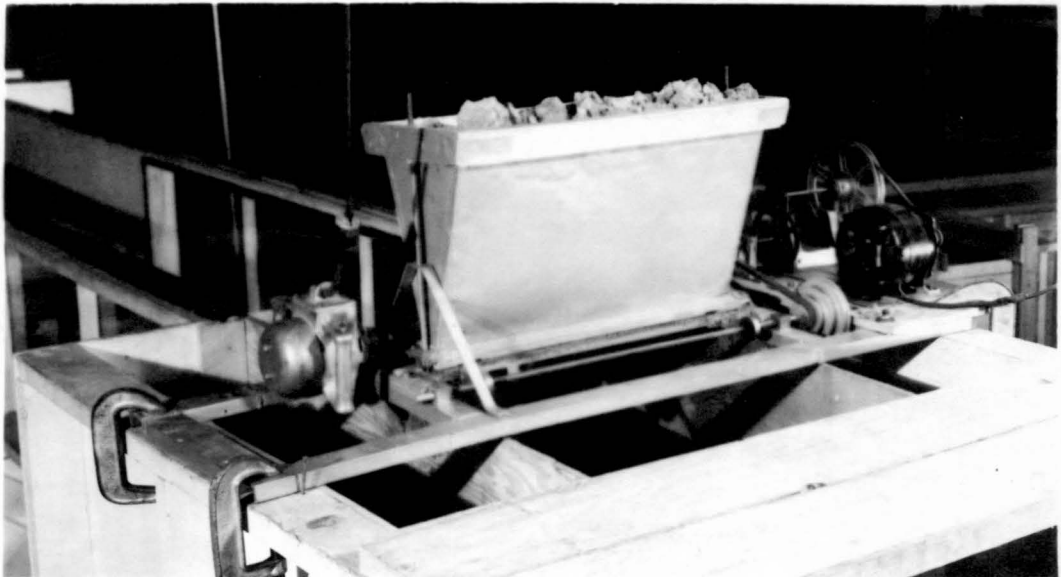

Fig. 8b General View of Sand-Feed Mechanism

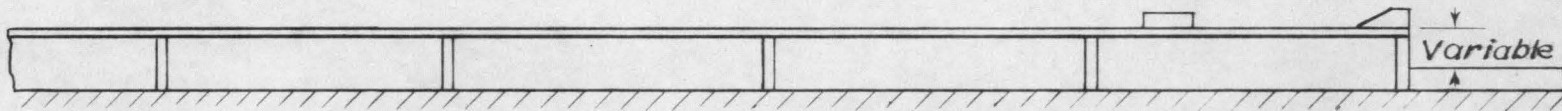
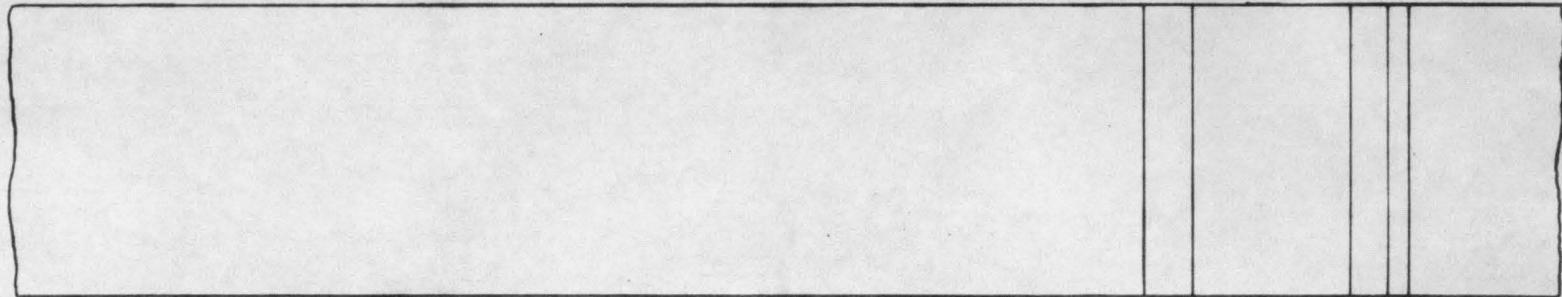

Fig. 5 Foundation of Model

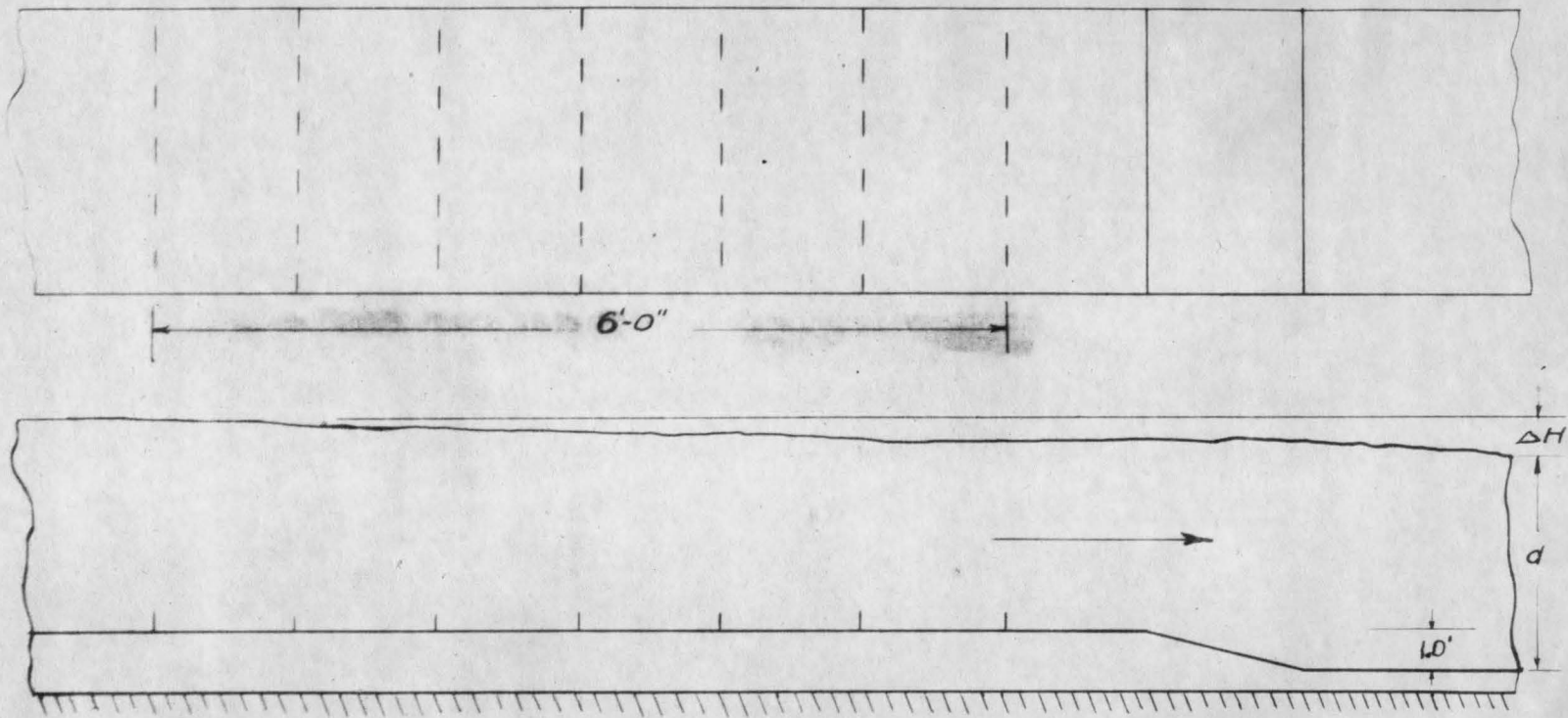

Fig. 6 Roughness Arrangement for Head Loss Experiment

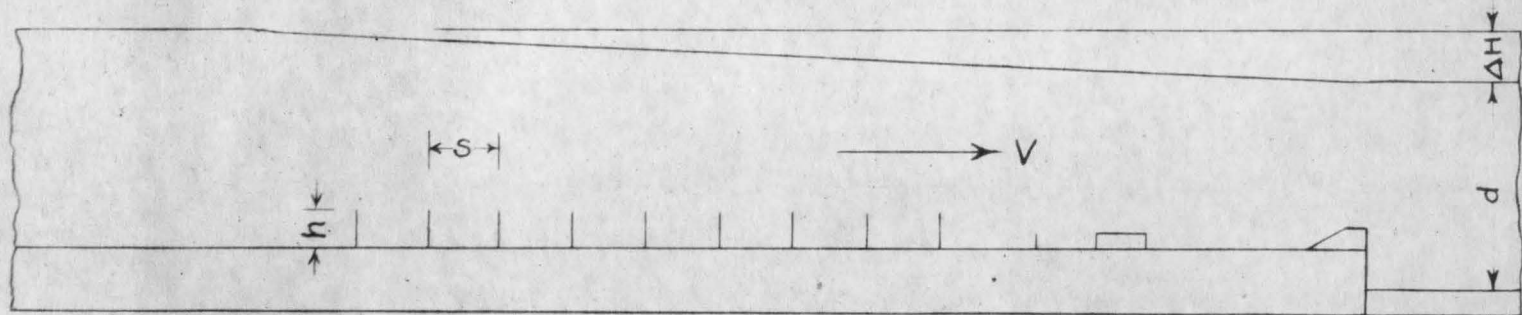
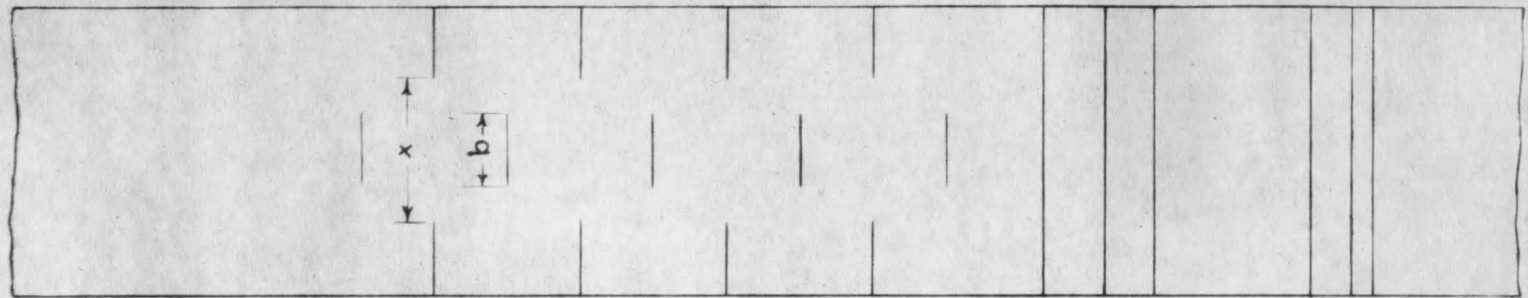
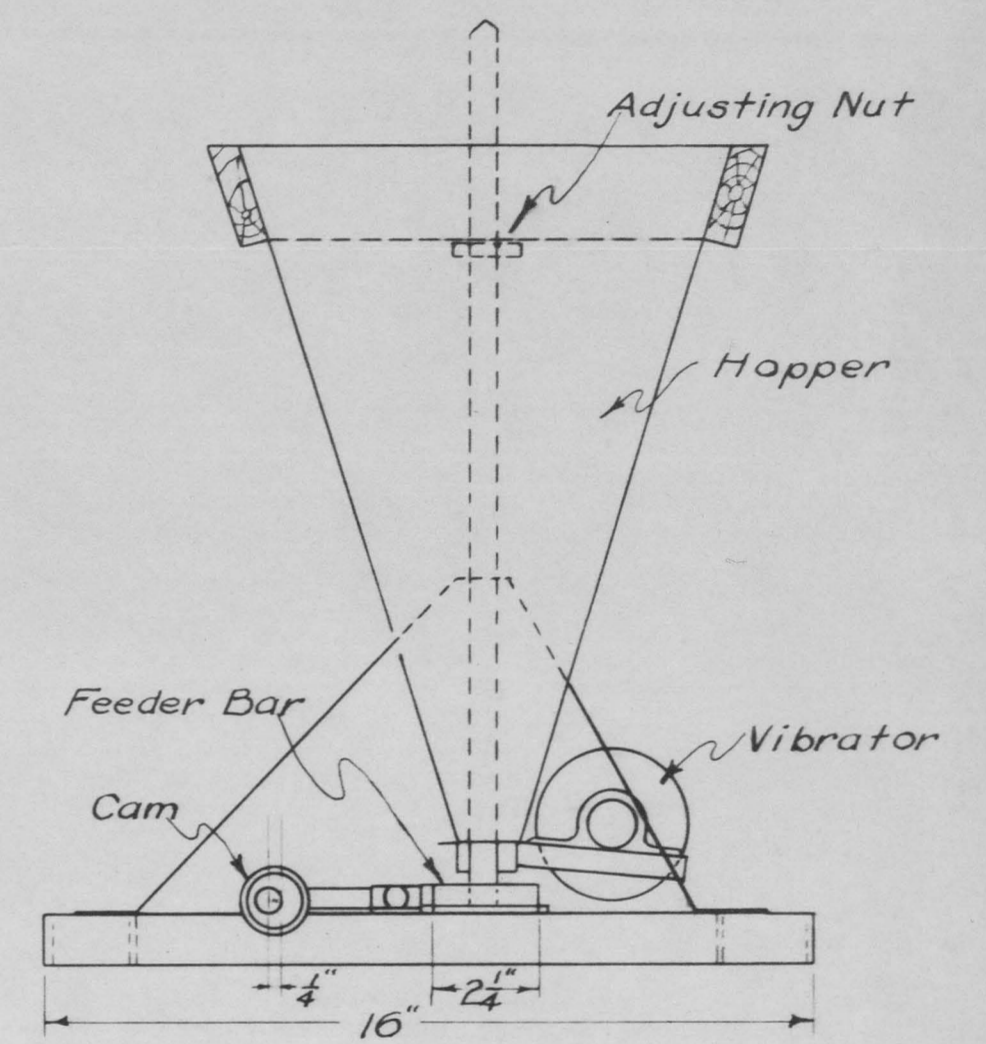
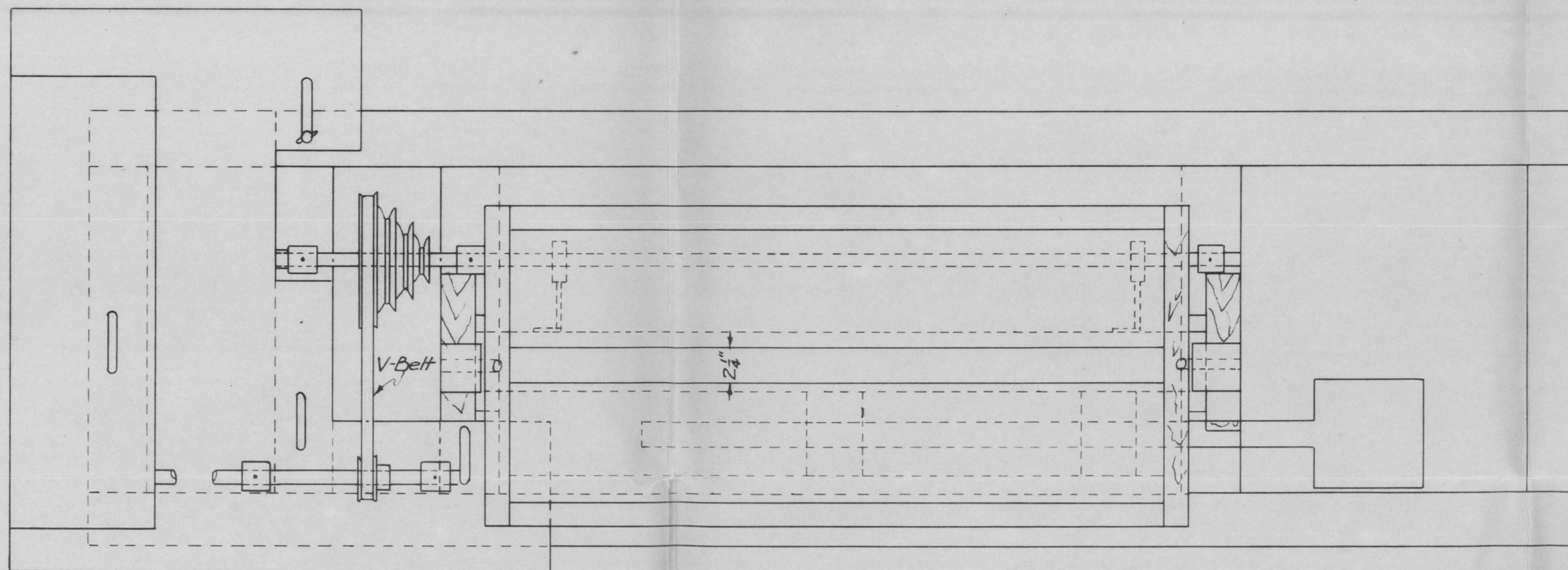

Fig. 7 Roughness Arrangement for Bed Load Experiments



Section A-A

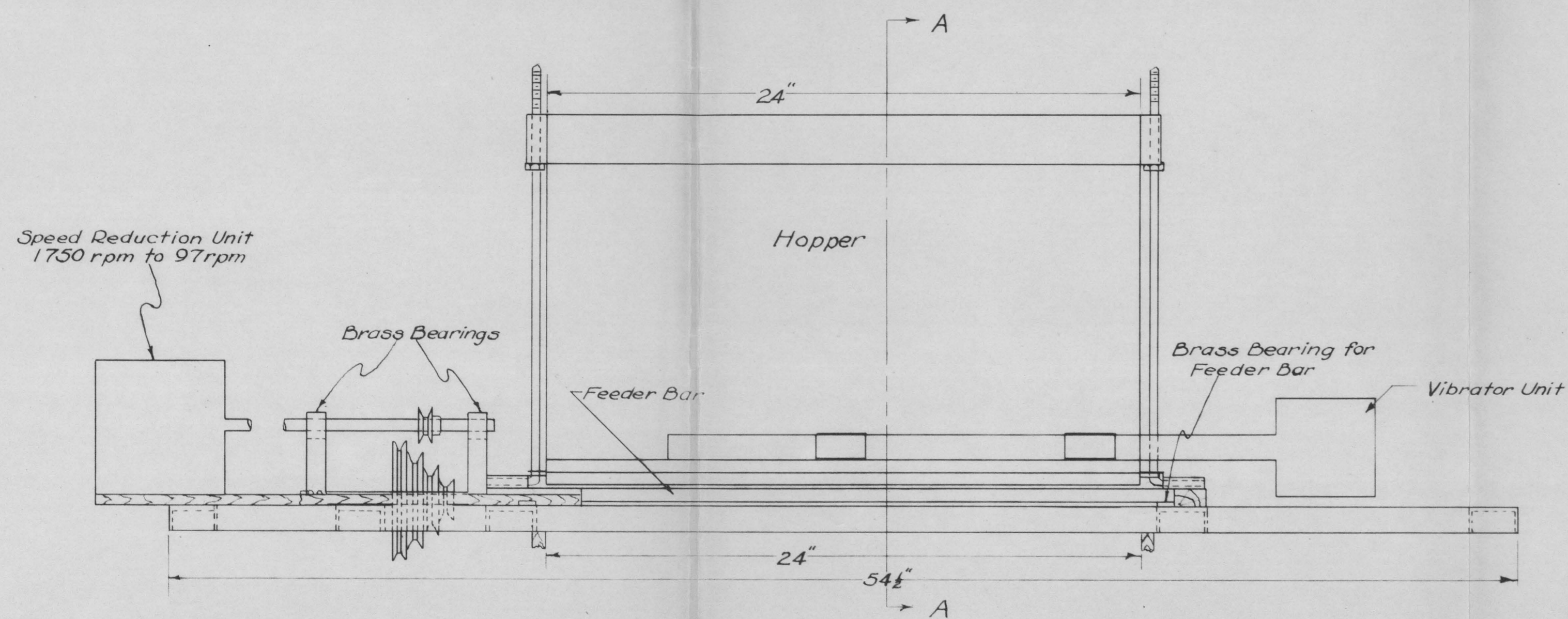

Fig. 8a Sand Feed Mechanism

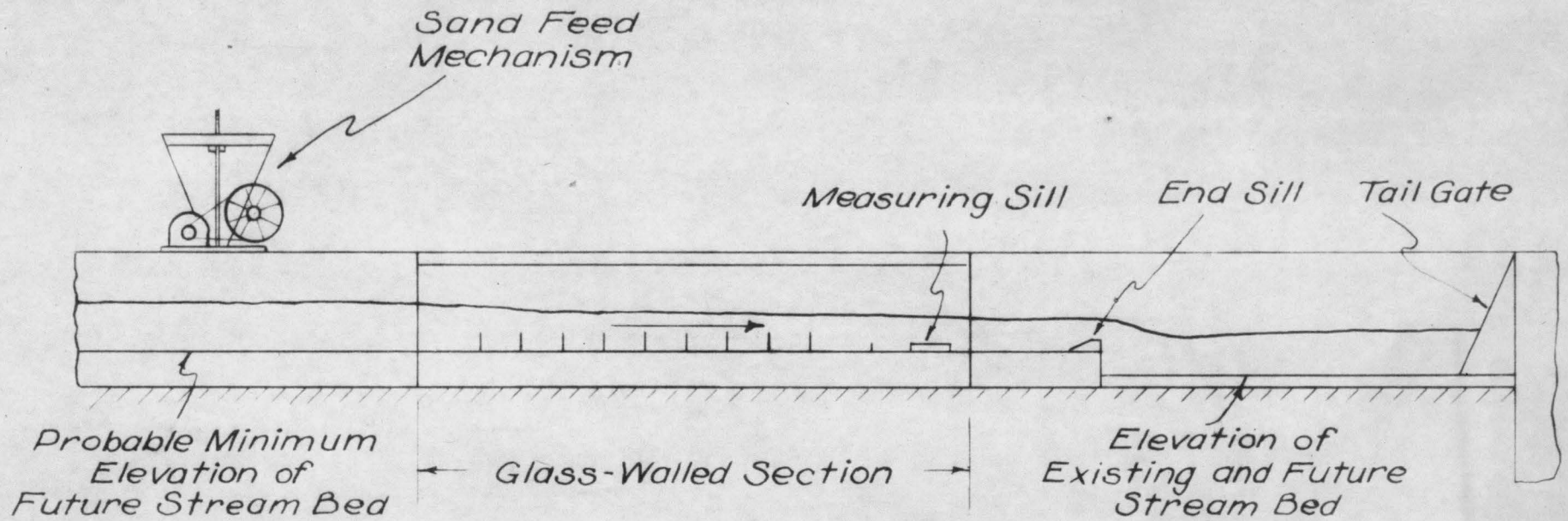

Fig.9 Relative Positions of Flume, Model, and Sand-Feed Mechanism

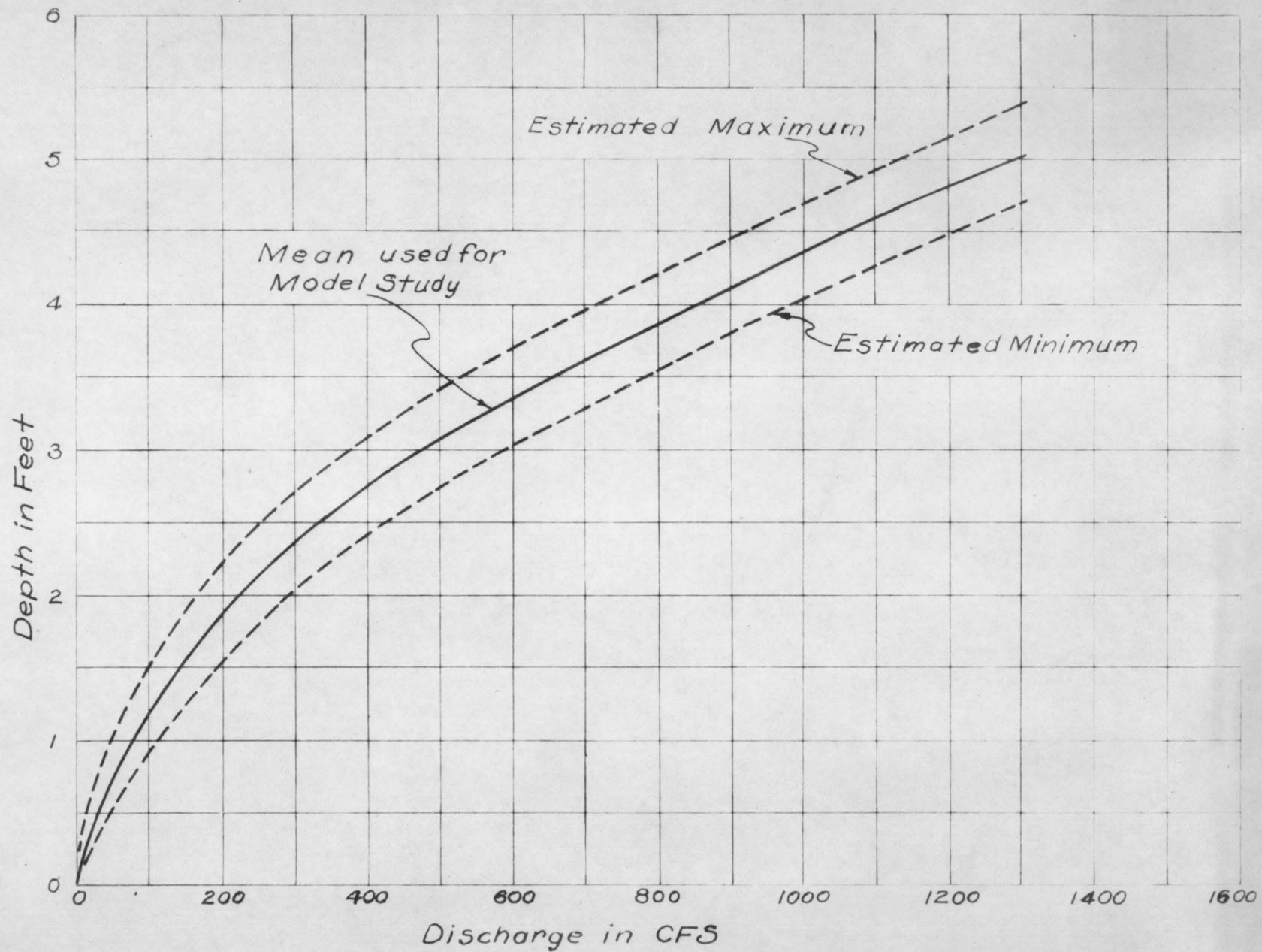

Fig. 10 Estimated Rating Curve at Highway No. 2 Bridge

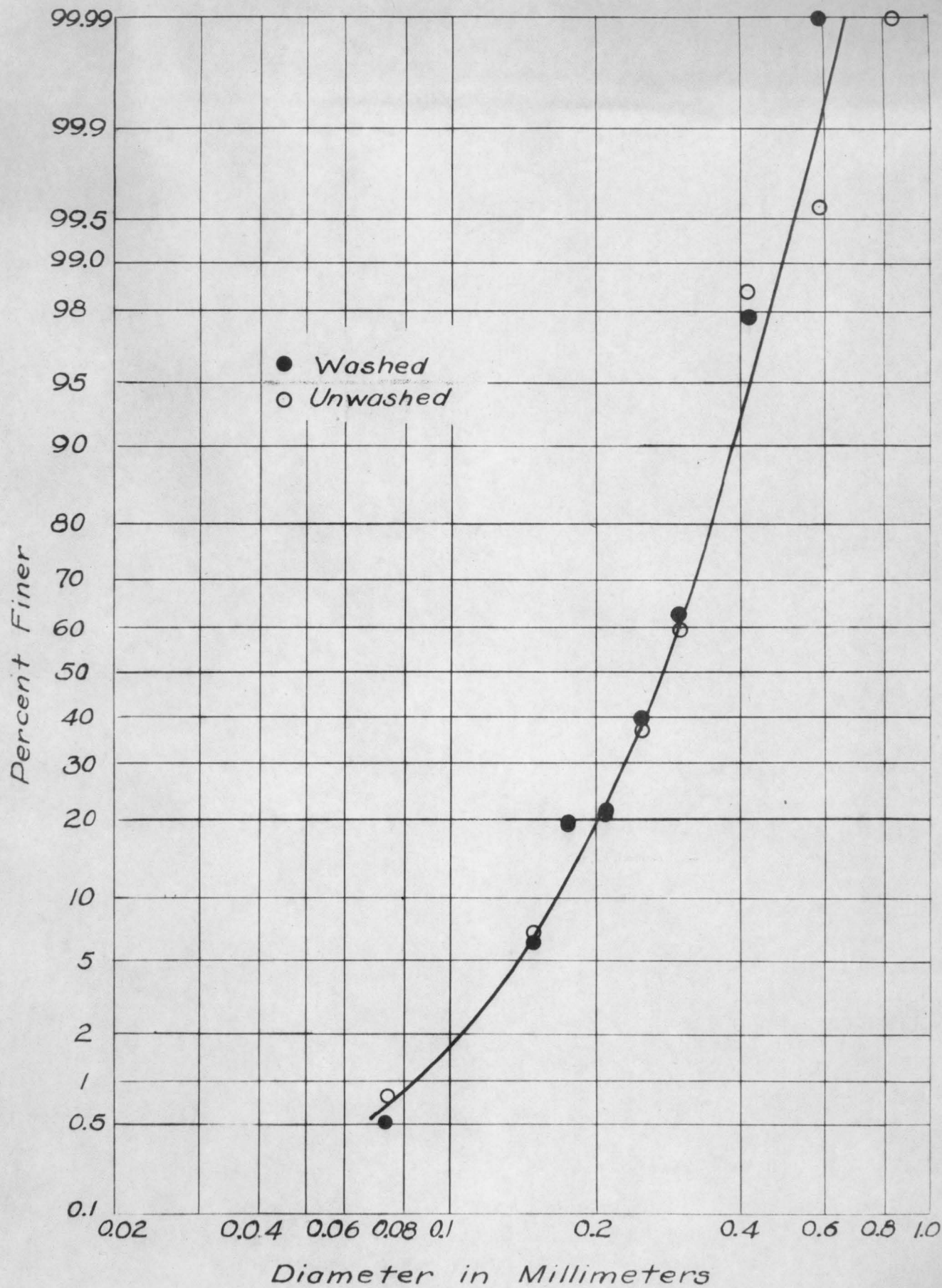

Fig. 11 Sieve Analysis of Sand used in Model

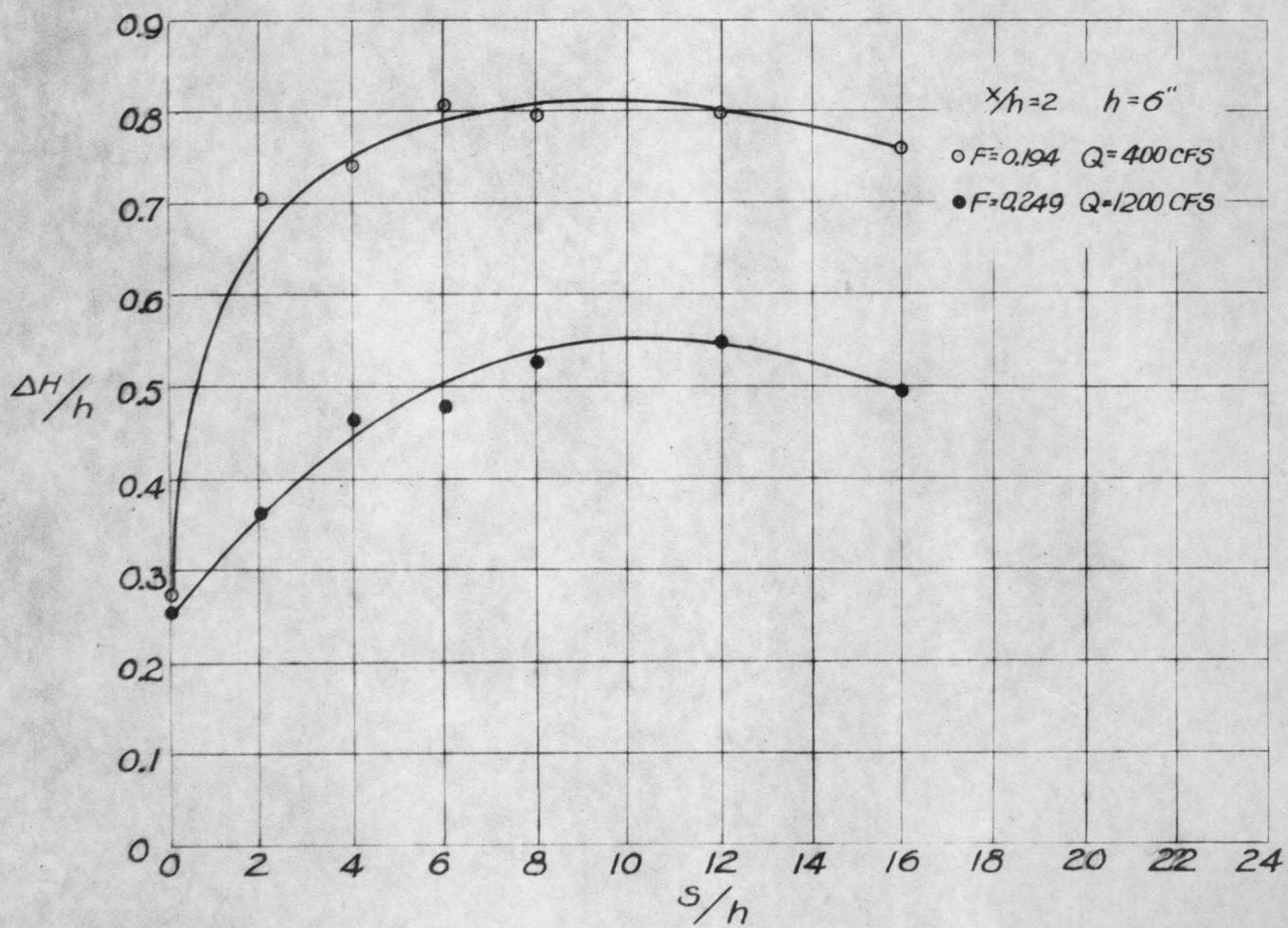
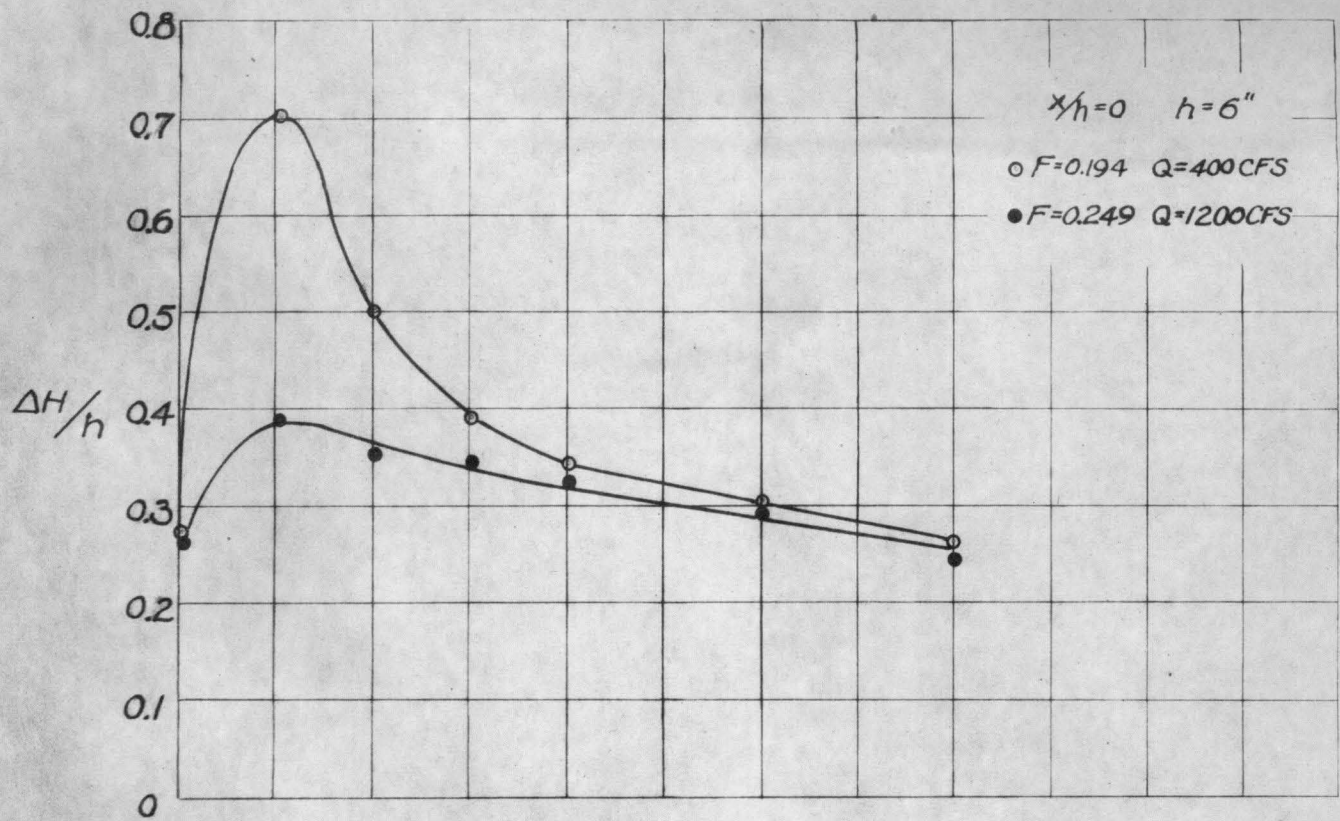

Fig.12 Variation of Head Loss with Longitudinal Spacing

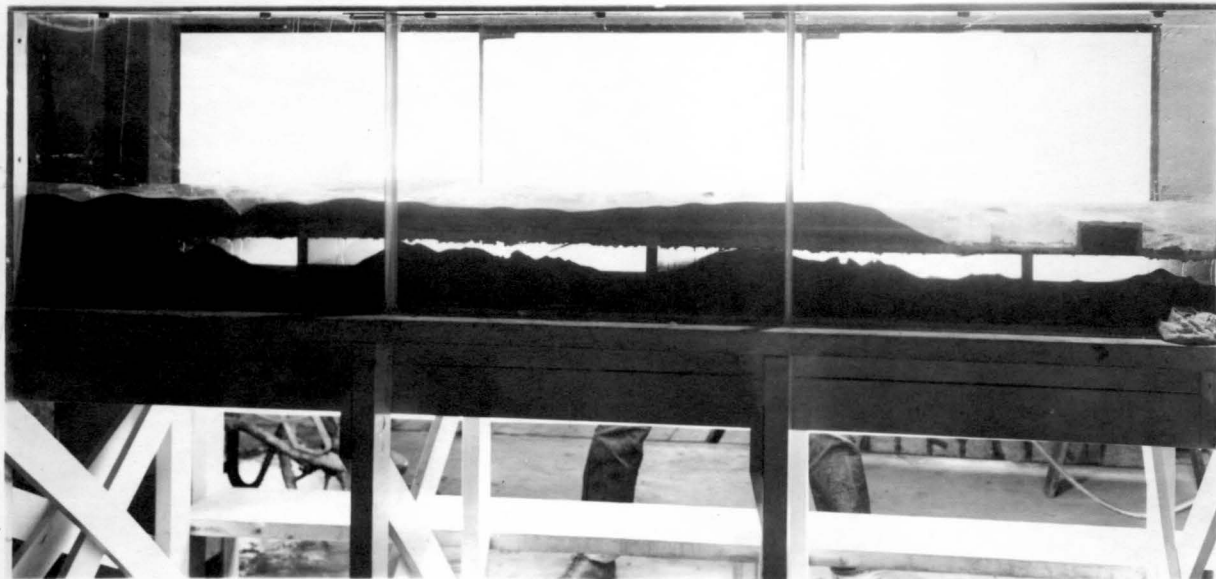

Fig. 13. Side Views with all Baffles 6" High and 2' Wide. Lateral Spacing 6' and Longitudinal Spacing 2' from Center to Center.
 $Q = 250$ CFS



Fig. 14. Top Views with all Baffles 6" High and 2' Wide. Lateral Spacing
6' and Longitudinal Spacing 2' from Center to Center.
 $Q = 250$ CFS

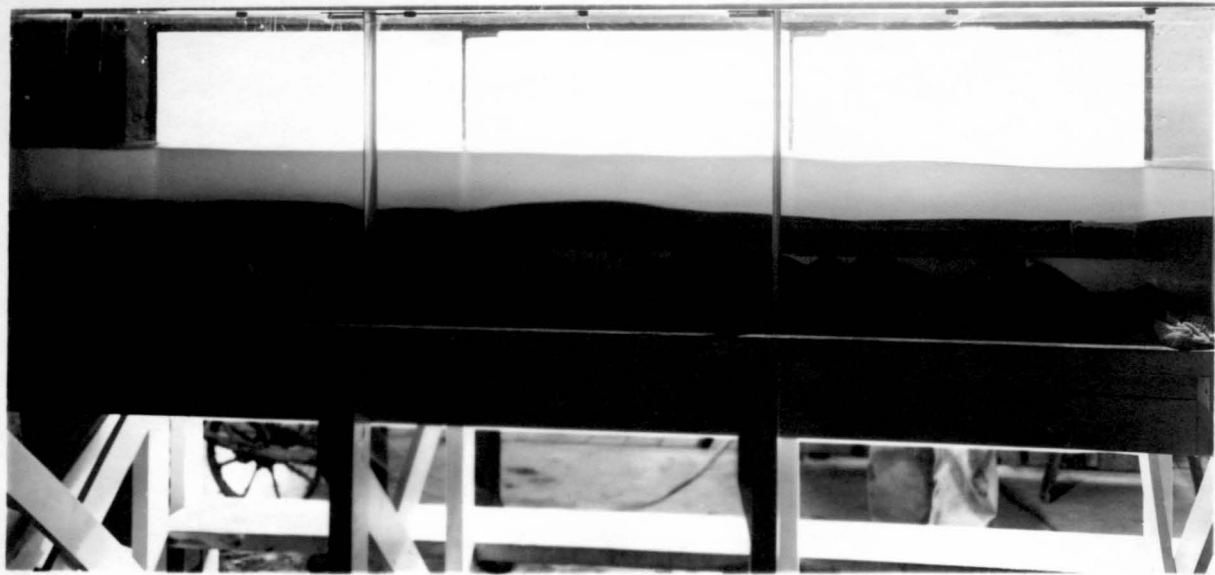

Fig. 15. Side Views with all Baffles 6" High and 2' Wide. Lateral Spacing 6' and Longitudinal Spacing 2' from Center to Center.
 $Q = 400$ CFS



Fig. 16. Top Views with all Baffles 6" High and 2' Wide. Lateral Spacing 6' and Longitudinal Spacing 2' from Center to Center.
 $Q = 400$ CFS

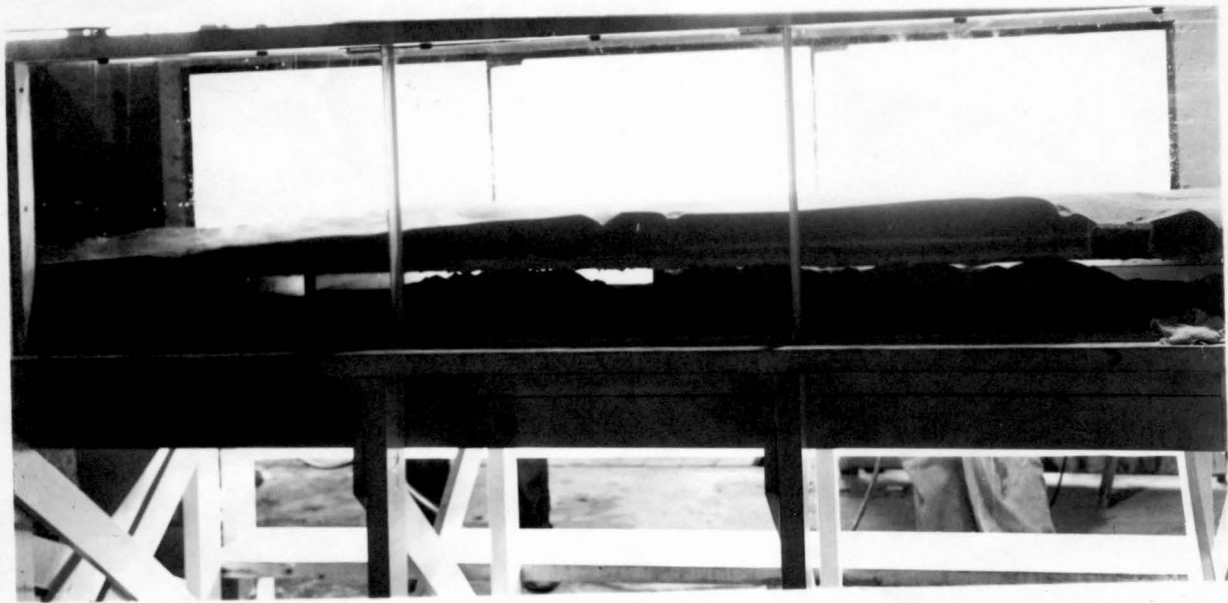

Fig. 17. Side Views with all Baffles 6" High and 2' Wide. Lateral Spacing 6' and Longitudinal Spacing 2' from Center to Center.
 $Q = 800$ CFS



Fig. 18. Top Views with all Baffles 6" High and 2' Wide. Lateral Spacing 6' and Longitudinal Spacing 2' from Center to Center.
 $Q = 800$ CFS



Fig. 19. Side Views with all Baffles 12" High and 2' Wide. Lateral Spacing 6' and Longitudinal Spacing 2' from Center to Center.
 $Q = 250$ CFS



Fig. 20. Top Views with all Baffles 12" High and 2' Wide. Lateral Spacing 6' and Longitudinal Spacing 2' from Center to Center.

$Q = 250$ CFS



Fig. 21. Side Views with all Baffles 12" High and 2' Wide. Lateral Spacing 6' and Longitudinal Spacing 2' from Center to Center.
 $Q = 400$ CFS



Fig. 22. Top Views with all Baffles 12" High and 2' Wide. Lateral Spacing
6' and Longitudinal Spacing 2' from Center to Center
 $Q = 400$ CFS

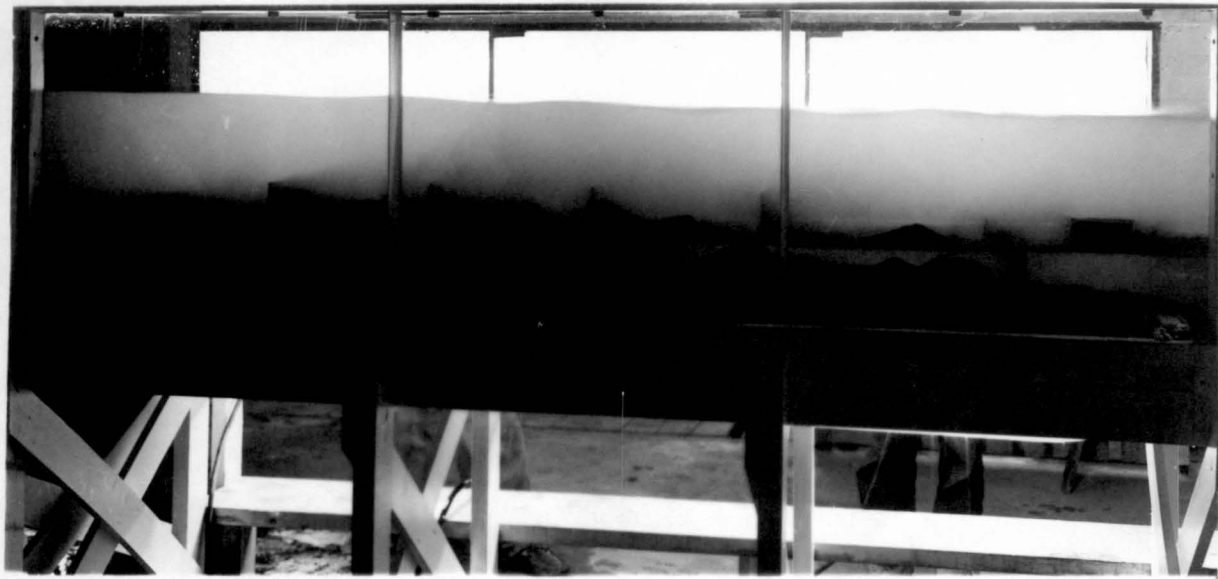

Fig. 23. Side Views with all Baffles 12" High and 2' Wide. Lateral Spacing 6' and Longitudinal Spacing 2' from Center to Center
 $Q = 800$ CFS

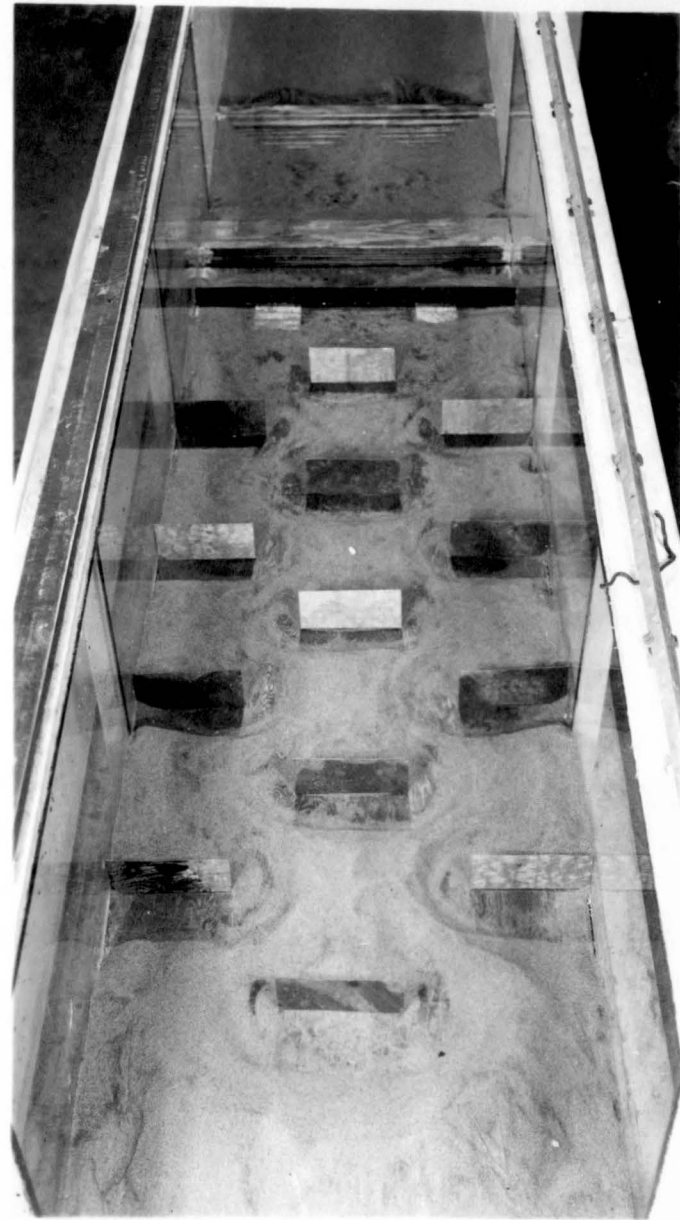

Fig. 24. Top Views with all Baffles 12" High and 2' Wide. Lateral Spacing
6' and Longitudinal Spacing 2' from Center to Center
 $Q = 800$ CFS

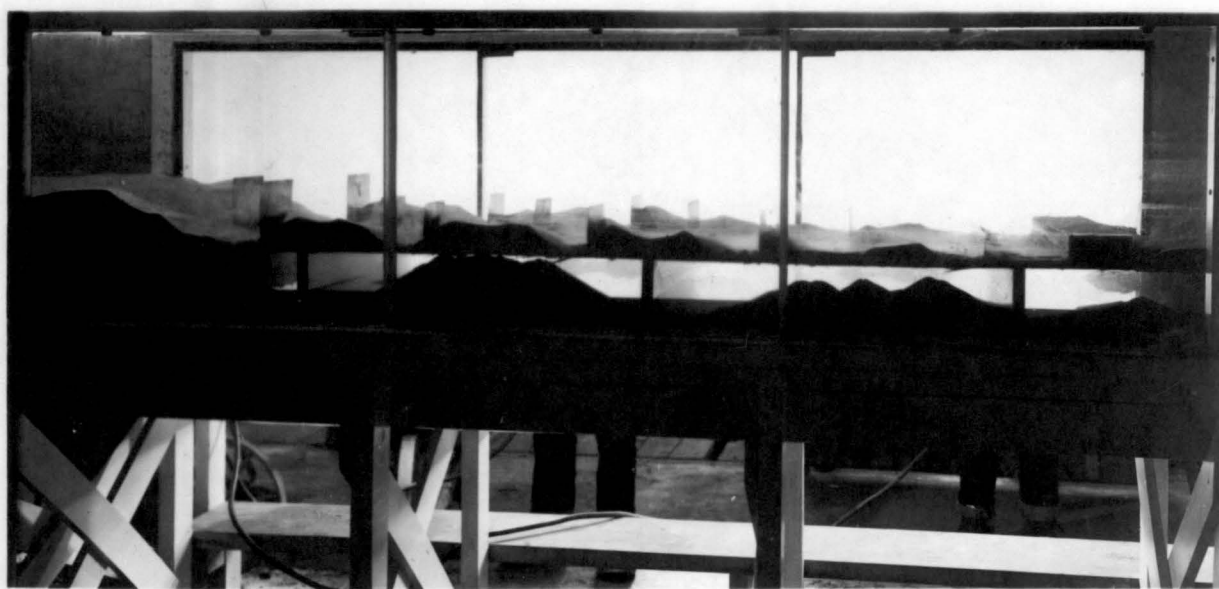
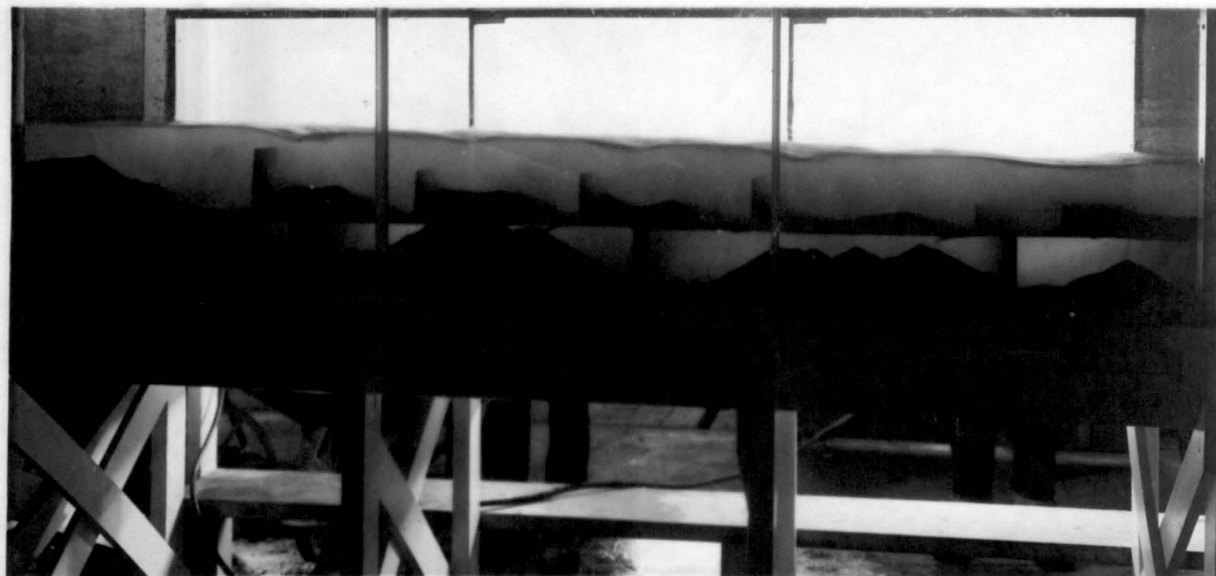

Fig. 25. Side Views with all Baffles 2' Wide. Two Upstream Rows 18" High and Remaining Rows 12" High. Lateral Spacing 6" and Longitudinal Spacing 2' from Center to Center
 $Q = 250$ CFS

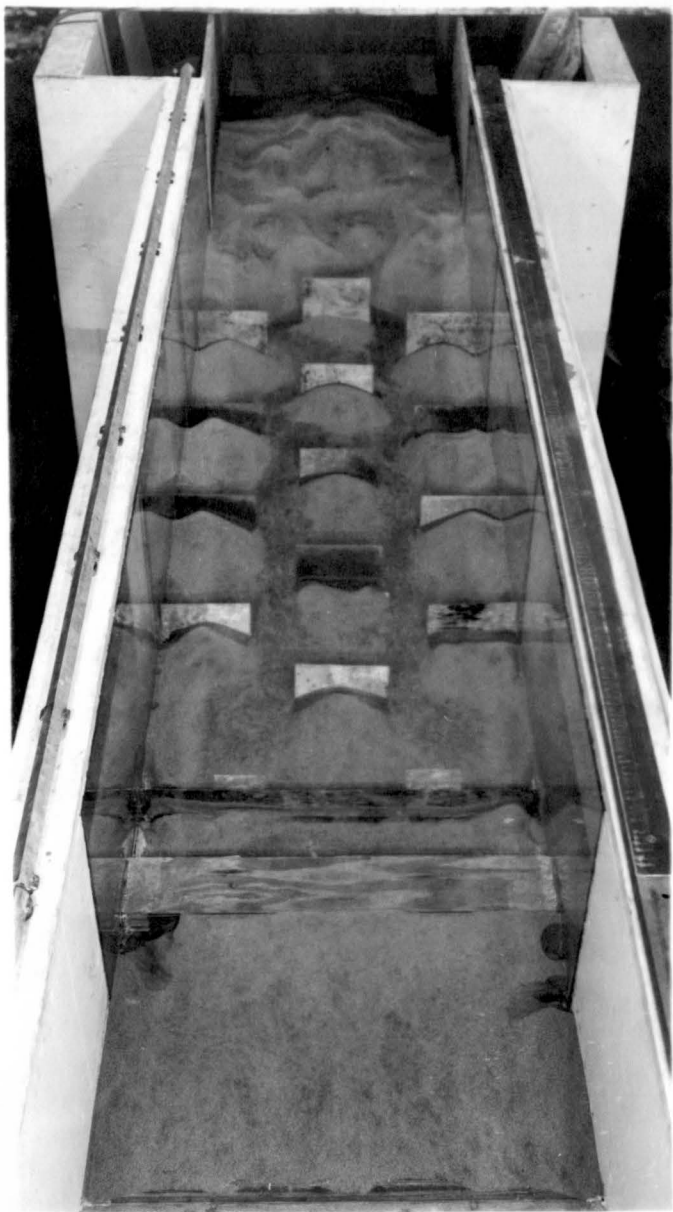

Fig. 26. Top Views with all Baffles 2' Wide. Two Upstream Rows 18" High and Remaining Rows 12" High. Lateral Spacing 6' and Longitudinal Spacing 2' from Center to Center. $Q = 250$ CFS

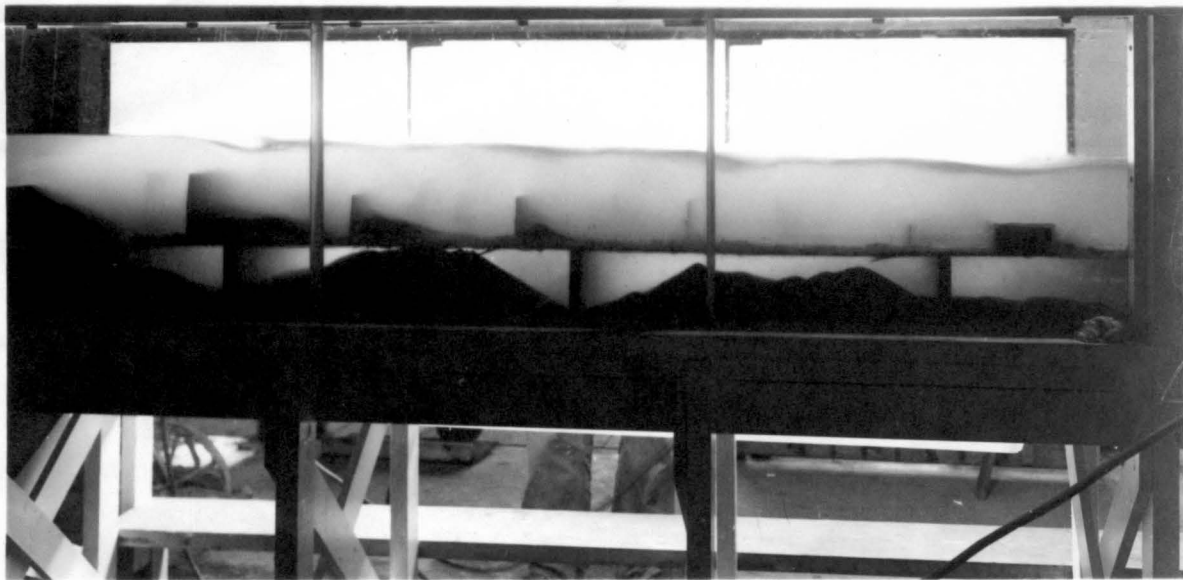

Fig. 27. Side Views with all Baffles 2' Wide. Two Upstream Rows
18" High and Remaining Rows 12" High. Lateral Spacing
6' and Longitudinal Spacing 2' from Center to Center.
 $Q = 400$ CFS



Fig. 28. Top Views with all Baffles 2' Wide. Two Upstream Rows 18" High and Remaining Rows 12" High. Lateral Spacing 6' and Longitudinal Spacing 2' from Center to Center. $Q = 400$ CFS

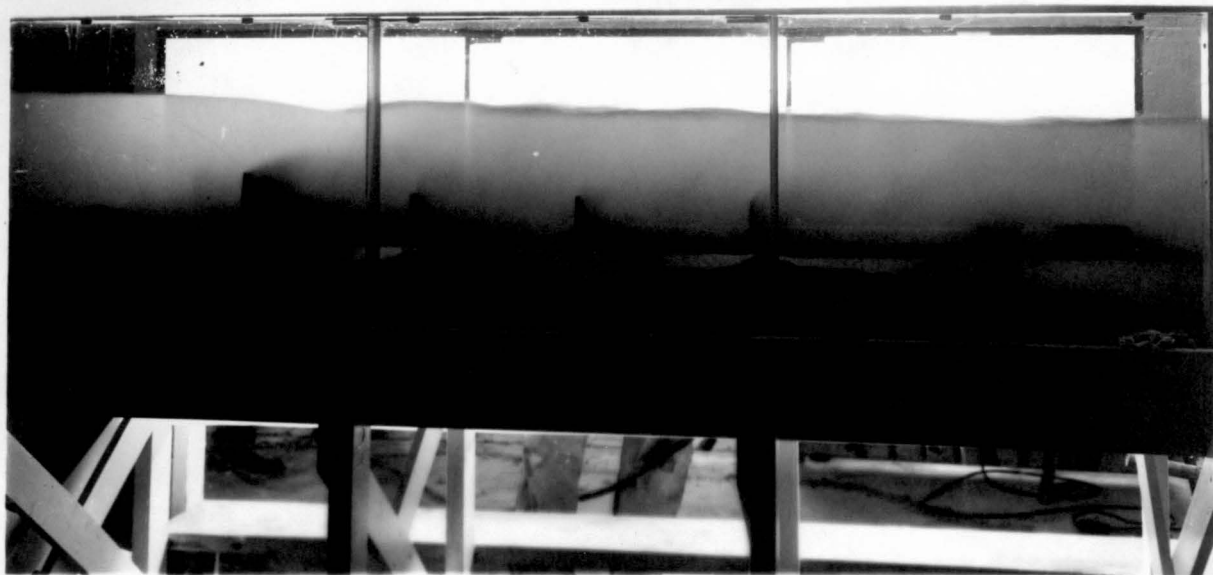

Fig. 29. Side View with all Baffles 2' Wide. Two Upstream Rows 18" High and Remaining Rows 12" High. Lateral Spacing 6' and Longitudinal Spacing 2' from Center to Center.
 $Q = 800$ CFS

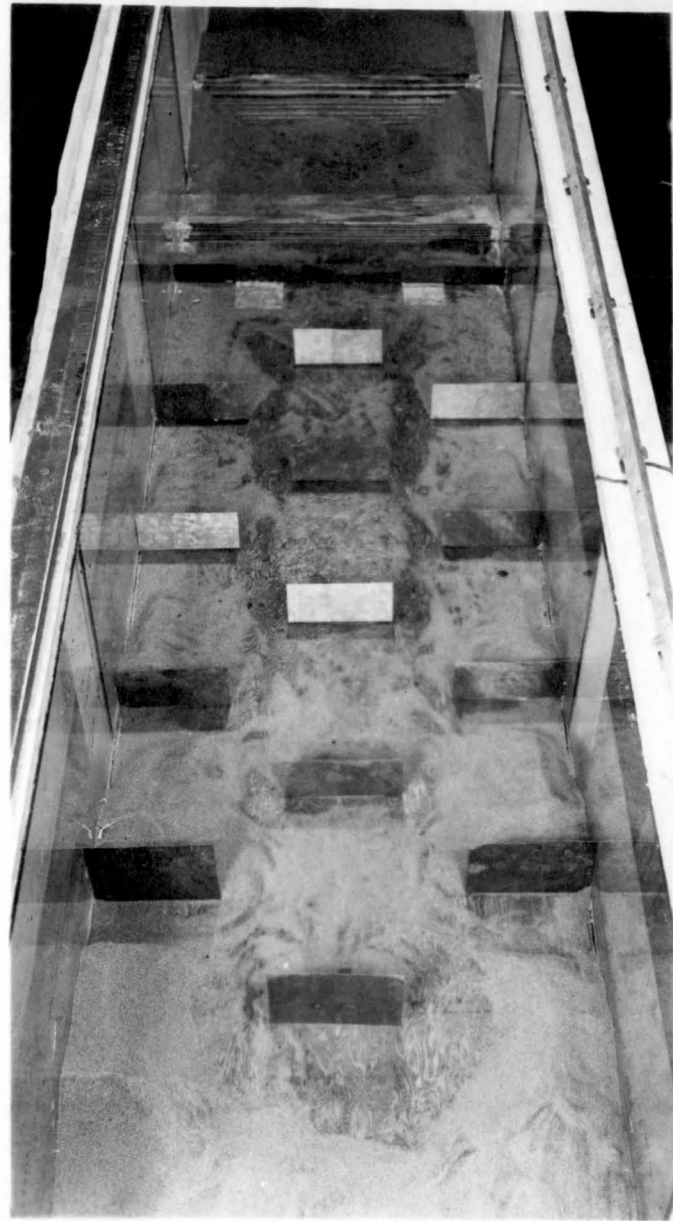
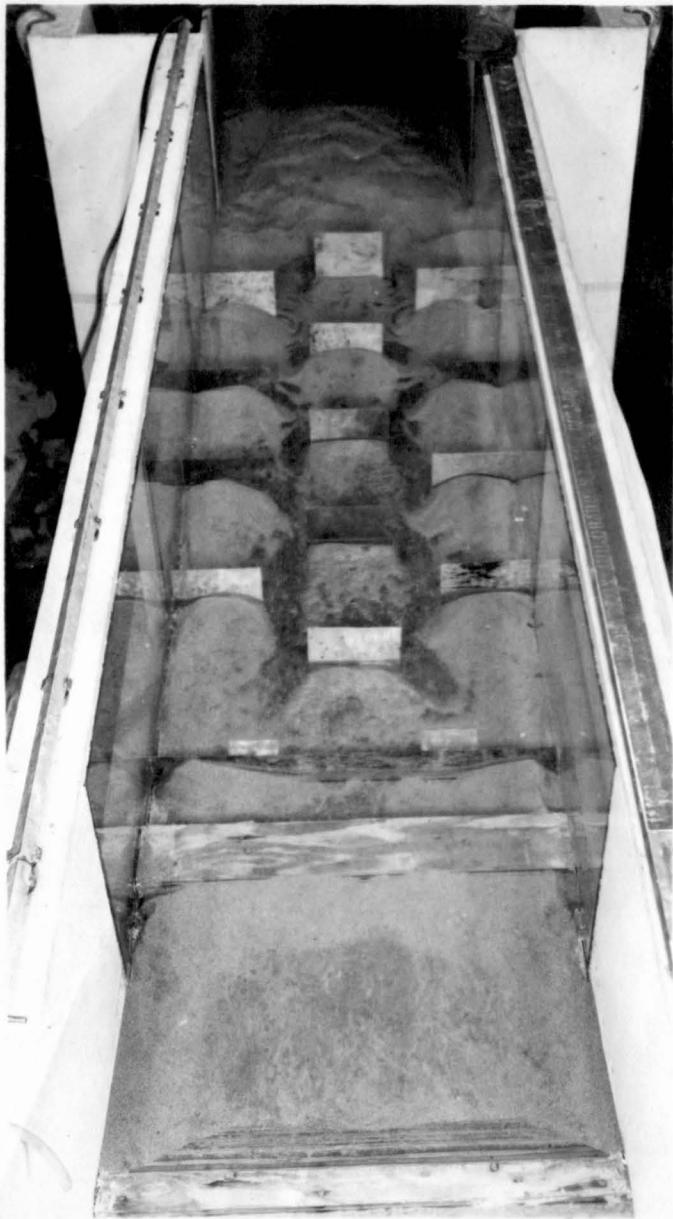

Fig. 30. Top Views with all Baffles 2' Wide. Two Upstream Rows 18" High and remaining Rows 12" High. Lateral Spacing 6' and Longitudinal Spacing 2' from Center to Center. $Q = 800$ CFS

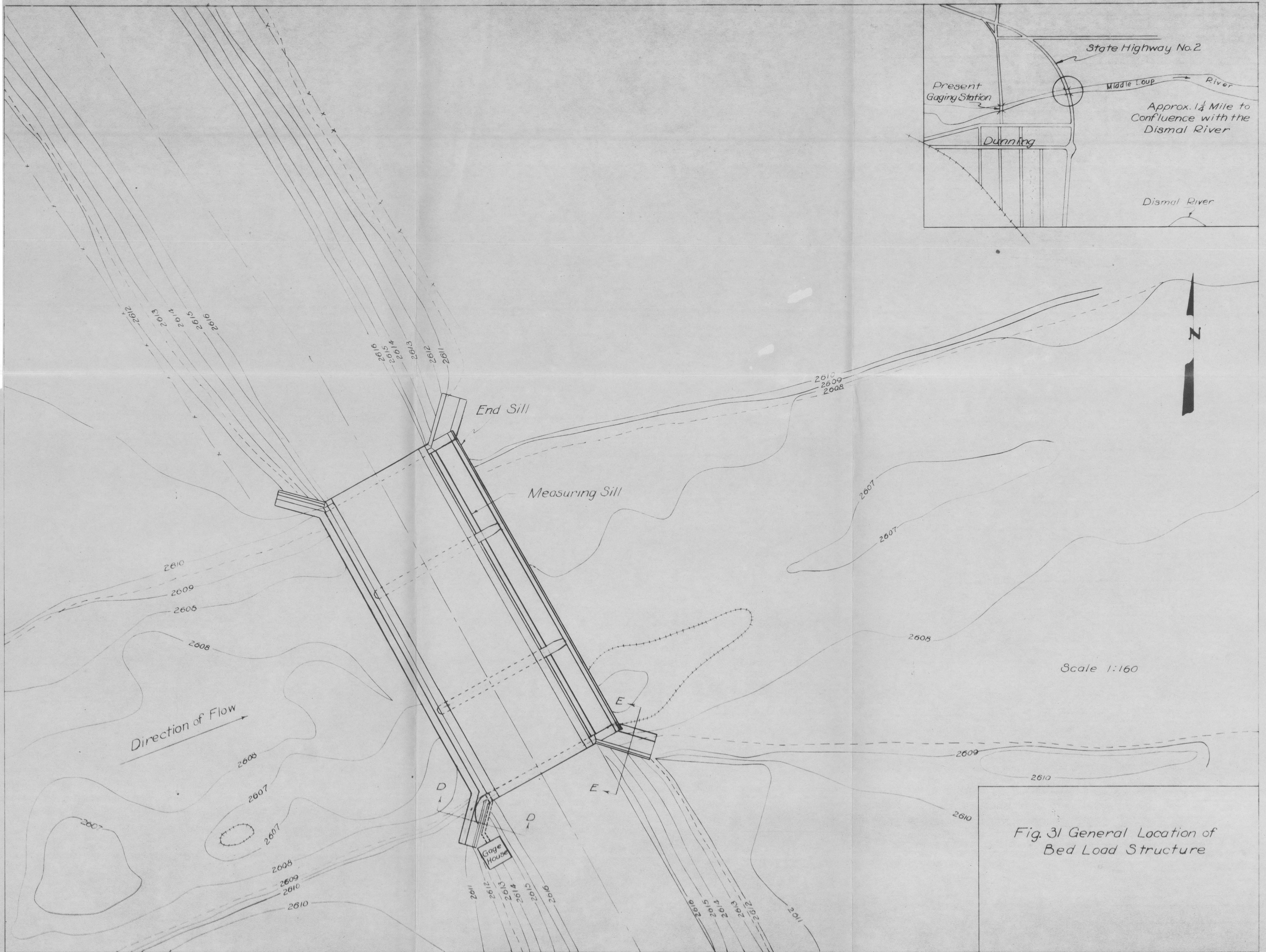

Fig. 31 General Location of Bed Load Structure

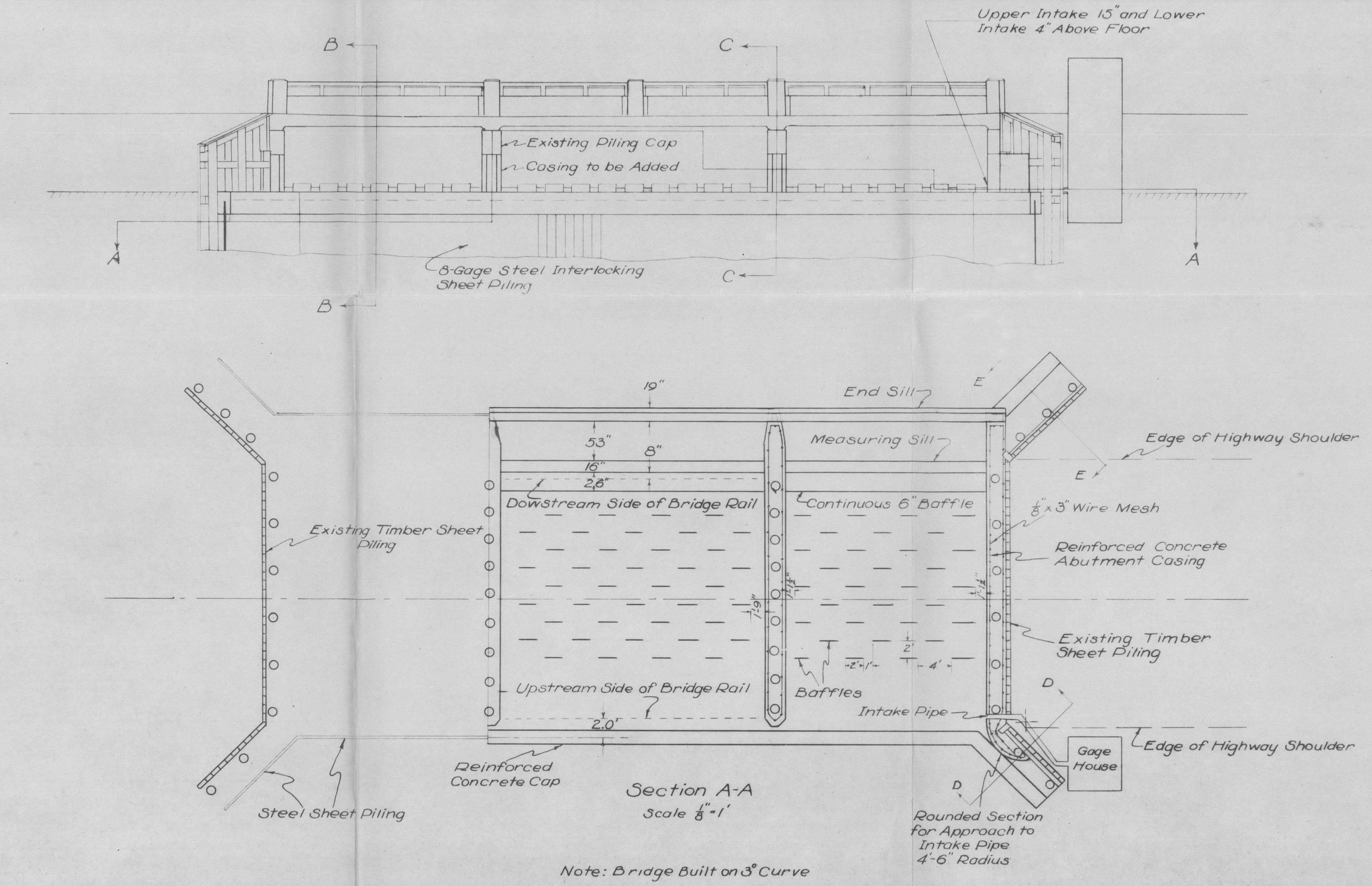
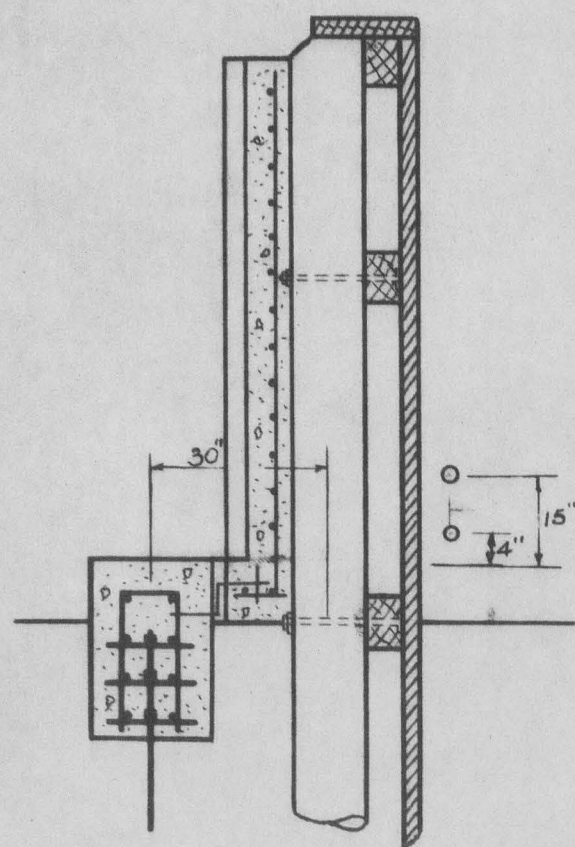
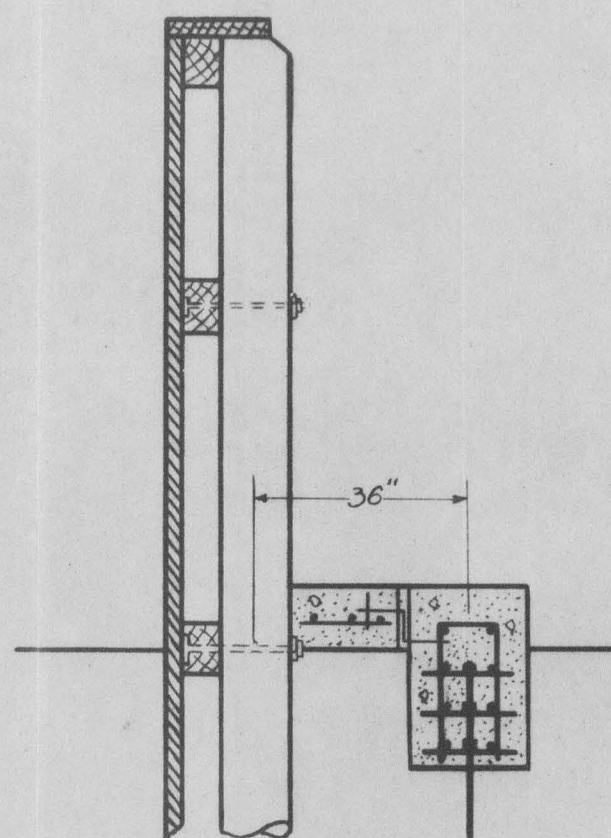

Fig. 32 Bed-Load Structure



Section D-D



Section E-E

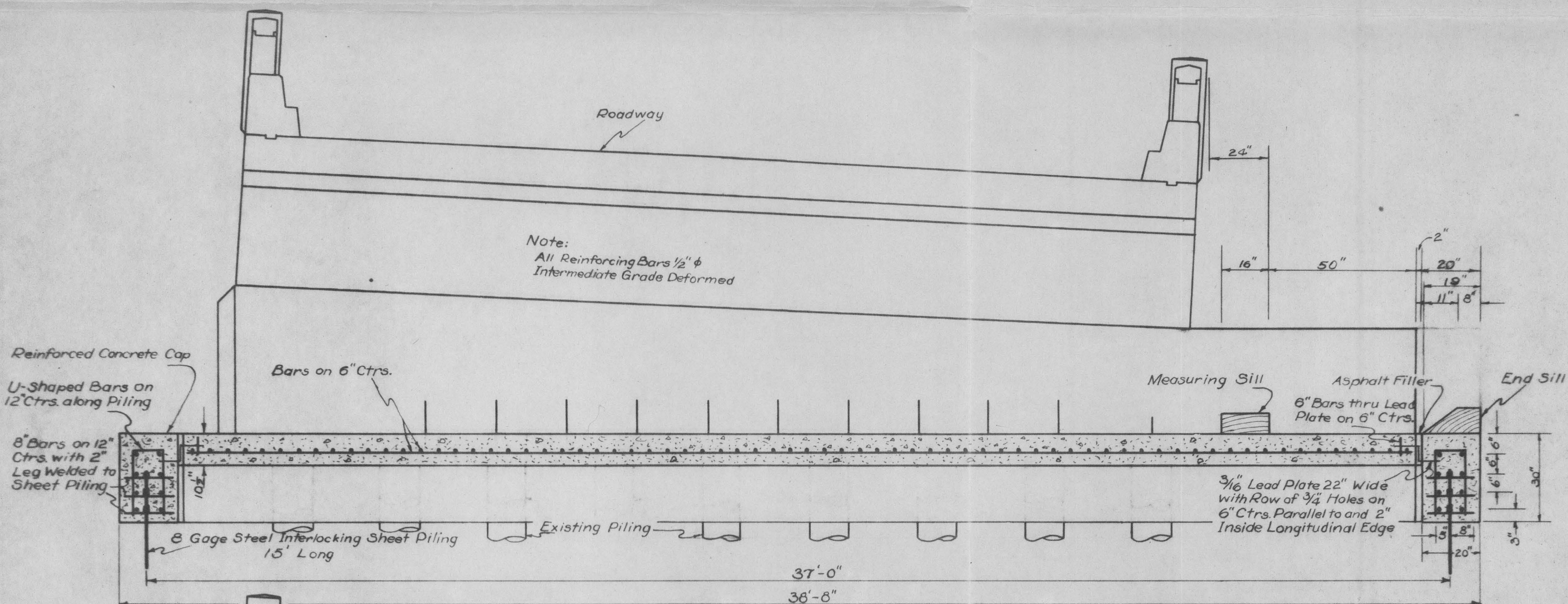

Section B-B

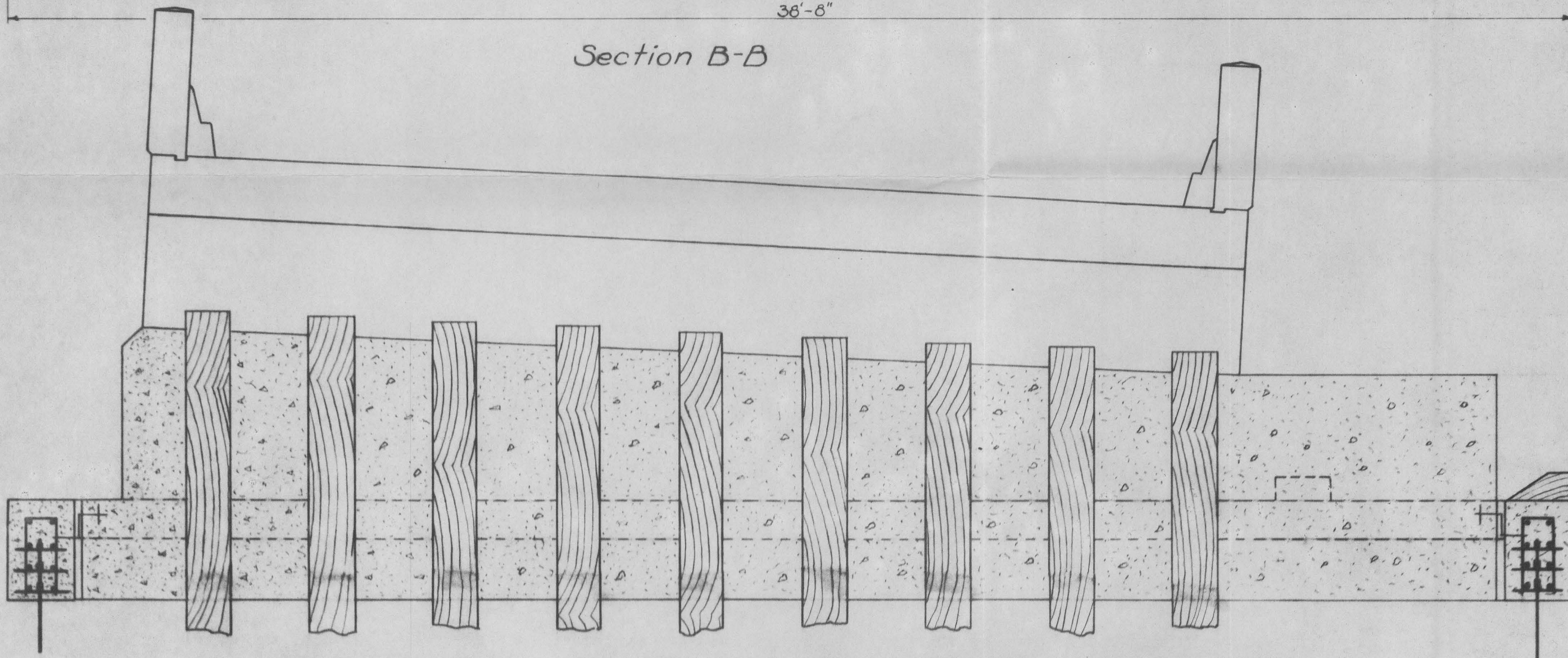

Section C-C

Fig. 33 Section Details

Fig. 33 Section Details