

WIND-TUNNEL STUDY OF
COLUMBIA PLAZA BUILDING, DENVER

by

J. A. Peterka* and J. E. Cermak**

Engineering Sciences

2 '78

Branch Library

for

Continental Cities Co., Inc.
919 Third Avenue
New York, New York 10022

Fluid Mechanics and Wind Engineering Program
Fluid Dynamics and Diffusion Laboratory
Department of Civil Engineering
Colorado State University
Fort Collins, Colorado 80523

August 1978

*Associate Professor
**Professor-in-Charge, Fluid Mechanics
and Wind Engineering Program

CER78-79JAP-JEC7



U18401 0075007

FOLIO
TA7
.CG
CER-78/79-7

50

TABLE OF CONTENTS

<u>Chapter</u>		<u>Page</u>
	LIST OF TABLES	iii
	LIST OF FIGURES	iv
	LIST OF SYMBOLS	v
1	INTRODUCTION	1
	1.1 General	1
	1.2 The Wind Tunnel Test	2
2	EXPERIMENTAL CONFIGURATION	5
	2.1 Wind Tunnel	5
	2.2 Model	5
3	INSTRUMENTATION AND DATA ACQUISITION	8
	3.1 Flow Visualization	8
	3.2 Pressures	8
	3.3 Velocity	10
4	RESULTS	13
	4.1 Flow Visualization	13
	4.2 Velocity	13
	4.3 Pressures	16
5	DISCUSSION	20
	REFERENCES	23
	FIGURES	24
	TABLES	50
	APPENDIX A	61

LIST OF TABLES

<u>Table</u>		<u>Page</u>
1	Motion Picture Scene Guide	50
2	Pedestrian Wind Velocities and Turbulence Intensities	51
3	Annual Percentage Frequencies of Wind Direction and Speed	55
4	Summary of Wind Effects on People	56
5	Calculation of Reference Pressure	57
6	Maximum Pressure Coefficients and Loads in PSF	58

LIST OF FIGURES

<u>Figure</u>		<u>Page</u>
1	Fluid Dynamics and Diffusion Laboratory	24
2	Wind Tunnel Configuration	25
3	Pressure Tap Locations	26
4	Building Location and Pedestrian Wind Velocity Measuring Positions	30
5	Completed Model in Wind Tunnel	31
6	Data Sampling Time Verification	32
7	Mean Velocity and Turbulence Profiles Approaching the Model	33
8	Mean Velocities and Turbulence Intensities at Pedestrian Locations	34
9	Wind Velocity Probabilities for Pedestrian Locations . .	42
10	Peak-Pressure Contours on the Building for Glass Loads .	48

LIST OF SYMBOLS

<u>Symbol</u>	<u>Definition</u>
U	Local mean velocity
D	Characteristic dimension (building height, width, etc.)
ν, ρ	Kinematic viscosity and density of approach flow
$\frac{UD}{\nu}$	Reynolds number
E	Mean voltage
A, B, n	Constants
U_{rms}	Root-mean-square of fluctuating velocity
E_{rms}	Root-mean-square of fluctuating voltage
U_{∞}	Reference mean velocity outside the boundary layer
X, Y	Horizontal coordinates
Z	Height above surface
δ	Height of boundary layer
T_u	Turbulence intensity $\frac{U_{rms}}{U_{\infty}}$ or $\frac{U_{rms}}{U}$
$C_{p_{mean}}$	Mean pressure coefficient, $\frac{(p-p_{\infty})_{mean}}{0.5 \rho U_{\infty}^2}$
$C_{p_{rms}}$	Root-mean-square pressure coefficient, $\frac{\left((p-p_{\infty}) - (p-p_{\infty})_{mean} \right)_{rms}}{0.5 \rho U_{\infty}^2}$
$C_{p_{max}}$	Peak maximum pressure coefficient, $\frac{(p-p_{\infty})_{max}}{0.5 \rho U_{\infty}^2}$
$C_{p_{min}}$	Peak minimum pressure coefficient, $\frac{(p-p_{\infty})_{min}}{0.5 \rho U_{\infty}^2}$
() _{min}	Minimum value during data record
() _{max}	Maximum value during data record
p	Fluctuating pressure at a pressure tap on the structure
p_{∞}	Static pressure in the wind tunnel above the model

1. INTRODUCTION

1.1 General

A significant characteristic of modern building design is lighter cladding and more flexible frames. These features produce an increased vulnerability of glass and cladding to wind damage and result in larger deflections of the building frame. In addition, increased use of pedestrian plazas at the base of the buildings has brought about a need to consider the effects of wind and gustiness in the design of these areas.

The building geometry itself may increase or decrease wind loading on the structure. Wind forces may be modified by nearby structures which can produce beneficial shielding or adverse increases in loading. Overestimating loads results in uneconomical design; underestimating may result in cladding or window failures. Tall structures have historically produced unpleasant wind and turbulence conditions at their bases. The intensity and frequency of objectionable winds in pedestrian areas is influenced both by the structure shape and by the shape and position of adjacent structures.

Techniques have been developed during the past decade for wind tunnel modeling of proposed structures which allow the prediction of wind pressures on cladding and windows, overall structural loading, and also wind velocities and gusts in pedestrian areas adjacent to the building. Information on sidewalk-level gustiness allows plaza areas to be protected by design changes before the structure is constructed. Accurate knowledge of the intensity and distribution of the pressures on the structure permits adequate but economical selection of window strength to meet selected maximum design winds and overall wind loads for the design of the frame for flexural control.

Modeling of the aerodynamic loading on a structure requires special consideration of flow conditions in order to guarantee similitude between model and prototype. A detailed discussion of the similarity requirements and their wind tunnel implementation can be found in References (1), (2), and (3). In general, the requirements are that the model and prototype be geometrically similar, that the approach mean velocity at the building site have a vertical profile shape similar to the full-scale flow, that the turbulence characteristics of the flows be similar, and that the Reynolds number for the model and prototype be equal.

These criteria are satisfied by constructing a scale model of the structure and its surroundings and performing the wind tests in a wind tunnel specifically designed to model atmospheric boundary-layer flows. Reynolds number similarity requires that the quantity UD/v be similar for model and prototype. Since v , the kinematic viscosity of air, is identical for both, Reynolds numbers cannot be made precisely equal with reasonable wind velocities. To accomplish this the air velocity in the wind tunnel would have to be as large as the model scale factor times the prototype wind velocity, a velocity which would introduce unacceptable compressibility effects. However, for sufficiently high Reynolds numbers ($>2 \times 10^4$) the pressure coefficient at any location on the structure will be essentially constant for a large range of Reynolds numbers. Typical values encountered are 10^7 - 10^8 for the full-scale and 10^5 - 10^6 for the wind-tunnel model. In this range acceptable flow similarity is achieved without precise Reynolds number equality.

1.2 The Wind Tunnel Test

The wind-engineering study is performed on a building or building group modeled at scales ranging from 1:150 to 1:400. The building model

is constructed of clear plastic fastened together with screws. The structure is modeled in detail to provide accurate flow patterns in the wind passing over the building surfaces. The building under test is often located in a surrounding where nearby buildings or terrain may provide beneficial shielding or adverse wind loading. To achieve similarity in wind effects the area surrounding the test building is also modeled. A flow visualization study is first made (smoke is used to make the air currents visible) to define overall flow patterns and identify regions where local flow features might cause difficulties in building curtain-wall design or produce pedestrian discomfort.

The test model, equipped with pressure taps (200 to 600 or more), is exposed to an appropriately modeled atmospheric wind in the wind tunnel and the fluctuating pressure at each tap measured electronically. The model, and the modeled area, are rotated 15 degrees and another set of data recorded for each pressure tap. Normally, 24 sets of data (360 degrees of turning) are taken; however, when flow visualization or recorded data indicate high pressure regions of small azimuthal extent, data is obtained in smaller azimuthal steps.

Data are recorded, analyzed and processed by an on-line computerized data-acquisition system. Pressure coefficients of several types are calculated by the computer for each reading on each piezometer tap and are printed in tabular form as computer readout. Using wind data applicable to the building site, representative wind velocities are selected for combination with measured pressures on the building model. Integration of test data with wind data results in prediction of peak local wind pressures for design of glass or cladding and may include overall forces and moments on the structure (by floor if desired) for design of

the structural frame. Pressure contours are drawn on the developed building surfaces showing the intensity and distribution of peak wind loads on the building. These results may be used to divide the building into zones where lighter or heavier cladding or glass may be desirable.

Based on the visualization (smoke) tests and on a knowledge of heavy pedestrian use areas, a dozen or more locations may be chosen at the base of the building where wind velocities can be measured to determine the relative comfort or discomfort of pedestrians in plaza areas, near building entrances, near building corners, or on sidewalks. Usually a reference pedestrian position is also tested to determine whether the wind environment in the building area is better or worse than the environment a block or so away in an undisturbed area.

The following pages discuss in greater detail the procedures followed and the equipment and data collecting and processing methods used. In addition, the data presentation format is explained and the implications of the data are discussed.

2. EXPERIMENTAL CONFIGURATION

2.1 Wind Tunnel

Wind-engineering studies are performed in the Fluid Dynamics and Diffusion Laboratory at Colorado State University (Figure 1). Three large wind tunnels are available for wind loading studies depending on the detailed requirements of the study. The wind tunnel used for this investigation is shown in Figure 2. All tunnels have a flexible roof adjustable in height to maintain a zero pressure gradient along the test section. The mean velocity can be adjusted continuously in each tunnel to the maximum velocity available.

2.2 Model

In order to obtain an accurate assessment of local pressures using piezometer taps, models are constructed to the largest scale that does not produce significant blockage in the wind-tunnel test section. The models are constructed of 1/2 in. thick Lucite plastic and fastened together with metal screws. Significant variations in the building surface, such as mullions, are machined into the plastic surface. Piezometer taps (1/16 in. dia) are drilled normal to the exterior vertical surfaces in rows at several or more elevations between the bottom and top of the building. Similarly, taps are placed in the roof and on any sloping, protruding, or otherwise distinctive features of the building that might need investigation.

Pressure tap locations are chosen so that the entire surface of the building can be investigated for pressure loading and at the same time permit critical examination of areas where experience has shown that maximum wind effects may be expected to occur. Locations of the pressure taps for this study are shown in Figure 3. Dimensions are given both for

full-scale building (in ft) and for model (in in.). The pressure tap numbers are shown adjacent to the taps.

The pressure tests are sometimes made in two stages. In the first stage measurements are made on the initial distribution of pressure taps. If it becomes apparent from the data that the loading on the building is being influenced by some unsuspected geometry of the building or adjacent structures, additional pressure taps are installed in the critical areas. The locations of the taps are selected so that the maximum loading can be detected and the area over which this loading is acting can be defined. Any added taps are also shown in Figure 3.

A circular area 750 to 2000 ft in radius depending on model scale and characteristics of the surrounding buildings and terrain is modeled in detail. Structures within the modeled region are made from styrofoam and cut to the individual building geometries. They are mounted on the turntable in their proper locations. Significant terrain features are included as needed. The model is mounted on a turntable (Figure 2) near the downwind end of the test section. Any buildings or terrain features which do not fit on the turntable are placed on preshaped pieces which are placed upwind of the turntable for appropriate wind directions. A plane view of the building and its surroundings is shown in Figure 4. The turntable is calibrated to indicate azimuthal orientation to 0.1 degree.

The region upstream from the modeled area is covered with a randomized roughness constructed using various sized cubes placed on the floor of the wind tunnel. Different roughness sizes may be used for different wind directions. Spires are installed at the test-section entrance to provide a thicker boundary-layer than would otherwise be available. The

thicker boundary-layer permits a somewhat larger scale model than would otherwise be possible. The spires are approximately triangularly shaped pieces of 1/2 in. thick plywood 6 in. wide at the base and 1 in. wide at the top, extending from the floor to the top of the test section. They are placed so that the broad side intercepts the flow. A barrier approximately 8 in. high is placed on the test-section floor downstream of the spires to aid in development of the boundary-layer flow.

The distribution of the roughness cubes and the spires in the roughened area was designed to provide a boundary-layer thickness of approximately 4 ft, a velocity profile power-law exponent similar to that expected to occur in the region approaching the modeled area for each wind direction (a number of wind directions may have the same approach roughness). A photograph of the completed model in the wind tunnel is shown in Figure 5. The wind-tunnel ceiling is adjusted after placement of the model to obtain a zero pressure gradient along the test section.

3. INSTRUMENTATION AND DATA ACQUISITION

3.1 Flow Visualization

Making the air flow visible in the vicinity of the model is helpful (a) in understanding and interpreting mean and fluctuating pressures, (b) in defining zones of separated flow and reattachment and zones of vortex formation where pressure coefficients may be expected to be high and (c) in indicating areas where pedestrian discomfort may be a problem. Titanium tetrachloride smoke is released from sources on and near the model to make the flow lines visible to the eye and to make it possible to obtain motion picture records of the tests. Conclusions obtained from these smoke studies are discussed in Sections 4.1 and 5.1.

3.2 Pressures

Mean and fluctuating pressures are measured at each of the pressure taps on the model structure. Data are obtained for 24 wind directions, rotating the entire model assembly in a complete circle. Seventy-six pieces of 1/16 in. I.D. plastic tubing each 18 in. long are used to connect 76 pressure ports at a time to an 80 tap pressure switch mounted inside the model. The switch was designed and fabricated in the Fluid Dynamics and Diffusion Laboratory to minimize the attenuation of pressure fluctuations across the switch. Each of the 76 measurement ports is directed in turn by the switch to one of four pressure transducers mounted close to the switch. The four pressure input taps not used for transmitting building surface pressures, are connected to a common tube leading outside the wind tunnel. This arrangement provides both a means of performing in-place calibration of the transducers and, by connecting this tube to a pitot tube mounted inside the wind tunnel, a means of automatically monitoring the tunnel speed. The switch is operated by

means of a shaft projecting through the floor of the wind tunnel. A computer-controlled stepping motor steps the switch into each of the 20 required positions. The computer keeps track of switch position but a digital readout of position is provided at the wind tunnel.

The pressure transducers used are Statham differential strain gage transducers (Model PM 283TC) with a 0.15 psid range. They were selected because of their stability and linearity in the required working range. The resonant frequency of the transducers is approximately 2,000 Hz. This is sufficiently high that transducer resonance effects on the measured pressures can be ignored. Reference pressures are obtained by connecting the reference sides of the four transducers, using plastic tubing, to the static side of a pitot tube mounted in the wind tunnel free stream above the model building. In this way the transducer measures the instantaneous difference between the local pressures on the surface of the building and the static pressure in the free stream above the model.

Each pressure transducer contains a built-in bridge similar to a Wheatstone Bridge. The bridge is monitored by a Honeywell Accudata 118 Gage Control/Amplifier unit which provides excitation to the transducer bridge and amplifies the bridge output. These instruments are characterized by a very stable excitation voltage and amplifier gain. Output from the Honeywell signal conditioners is fed to an on-line data acquisition system consisting of a Hewlett-Packard 21 MX computer, disk unit, card reader, printer, Digi-Data digital tape drive and a Preston Scientific analog-to-digital convertor. The data are processed immediately into pressure coefficient form as described in Section 4.3 and stored for printout or further analysis.

All four transducers are recorded simultaneously for 16 seconds at a 250 sample per second rate. The results of an experiment to determine the length of record required to obtain stable mean and rms (root-mean-square) pressures and to determine the overall accuracy of the pressure data acquisition system is shown in Figure 6. A typical pressure port record was integrated for a number of different time periods to obtain the data shown. Examination of a large number of pressure taps showed that the overall accuracy for a 16 second period is, in pressure coefficient form, 0.03 for mean pressures, 0.1 for peak pressures, and 0.01 for rms pressures. Pressure coefficients are defined in Section 4.3.

3.3 Velocity

Mean velocity and turbulence intensity profiles are measured upstream of the model to determine that an approach boundary-layer flow appropriate to the site has been established. Tests are made at one wind velocity in the tunnel. This velocity is well above that required to produce Reynolds number similarity between the model and the prototype as discussed in Section 1.1.

In addition, mean velocity and turbulence intensity measurements are made 5 to 7 feet (prototype) above the surface at a dozen or more locations on and near the building for 16 wind directions. The measurement locations are shown on Figure 4. The surface measurements are indicative of the wind environment to which a pedestrian at the measurement location would be subjected. The locations are chosen to determine the degree of pedestrian comfort or discomfort at the building corners where relatively severe conditions frequently are found, near building entrances and on adjacent sidewalks where pedestrian traffic is heavy, and in open plaza areas. In most studies a reference pedestrian position,

located about a block away, is also tested. These data are helpful in evaluating the degree of pedestrian comfort or discomfort in the proposed plaza area in terms of the undisturbed environment in the immediate vicinity.

Measurements are made with a single hot-wire anemometer mounted with its axis vertical. The instrumentation used is a Thermo Systems constant temperature anemometer (Model 1050) with a 0.001 in. dia platinum film sensing element 0.020 in. long. Output is read from a digital voltmeter with a time-constant circuit for mean voltage and a DISA RMS meter (Model 55035) for rms voltage.

Calibration of the hot-wire anemometer is performed using a Thermo Systems calibrator (Model 1125). The calibration data are fit to a variable exponent King's Law relationship of the form

$$E^2 = A + BU^n$$

where E is the hot-wire output voltage, U the velocity and A , B , and n are coefficients selected to fit the data. The above relationship was used to determine the mean velocity at measurement points using the measured mean voltage. The fluctuating velocity in the form U_{rms} (root-mean-square velocity) was obtained from

$$U_{\text{rms}} = \frac{2 E E_{\text{rms}}}{B n U^{n-1}}$$

where E_{rms} is the root-mean-square voltage output from the anemometer. For interpretation all turbulence measurements were divided by both local mean velocity U and mean velocity outside the boundary-layer U_{∞} . Division by U gives an indication of the relative unsteadiness at the location while division by U_{∞} permits an easy determination of the

actual magnitude of rms velocity fluctuations at a point for various approach velocities.

4. RESULTS

4.1 Flow Visualization

A film is included as part of this report showing the characteristics of flow about the structure using smoke to make the flow visible. A listing of the contents of the film is shown in Table 1. Several features can be noted from the visualization. As with all large structures, wind approaching the building is deflected down to the plaza level, up over the structure and around the sides. A description of the smoke test results emphasizing flow patterns of concern relative to possible high-wind load areas and pedestrian comfort is given in Section 5.1.

4.2 Velocity

Velocity and turbulence profiles are shown in Figures 7a and 7b. These profiles were taken upstream from the model and are characteristic of the boundary-layer approaching the model. As shown in Figure 7a, the boundary-layer thickness, δ , was 50 in. The corresponding prototype value of δ for this study is shown in Figure 7a. This value was established as a reasonable height for this study. The mean velocity profile has the form

$$\frac{U}{U_{\infty}} = \left(\frac{z}{\delta}\right)^n .$$

The exponent n for the approach flow established for this study is shown in Figure 7a.

The profile of longitudinal turbulence intensity is shown in Figure 7b. The turbulence intensities are appropriate for the approach mean velocity profile selected. For the purpose of this report, turbulence intensity is defined as the root-mean-square about the mean of the longitudinal velocity fluctuations divided by the reference mean velocity

U_∞ at the outer edge of the boundary layer,

$$Tu_1 = \frac{U_{rms}}{U_\infty},$$

or as the rms velocity divided by the local mean velocity,

$$Tu_2 = \frac{U_{rms}}{U}.$$

Mean velocity U/U_∞ , turbulence intensity U_{rms}/U_∞ , and "gustiness" U_{rms}/U at the pedestrian measuring positions shown in Figure 4 are listed in Table 2 for 16 wind directions and are plotted in polar form in Figures 8a, 8b, etc. Measurements were taken 5 to 7 ft above the ground surface. A site map is superimposed on the polar plots to aid in visualization of the effects of the nearby structures on the velocity and turbulence magnitudes. An analysis of these wind data is given in Section 5.2.

To enable a quantitative assessment of the wind environment, the wind-tunnel data were combined with wind frequency and direction information obtained at the local airport. Table 3 shows wind frequency by direction and magnitude obtained from summaries published by the National Weather Service. These data, usually obtained at an elevation of about 30 to 40 ft, were converted to velocities at the reference velocity height for the wind tunnel measurements and combined with the wind tunnel data to obtain cumulative probability distributions (percent time a given velocity is exceeded) for wind velocity at each measuring location. The percentage times were summed by wind direction to obtain a percent time exceeded at each measuring position independent of wind direction (but accounting for the fact that the wind blows from different directions with varying frequency). These results are plotted in Figure 9a, 9b, etc.

Interpretation of Figure 9 is aided by a description of the effects of wind of various magnitudes on people. The earliest quantitative description of wind effects was established by Sir Francis Beaufort in 1806 for use at sea and is still in use today. Several recent investigators have added to the knowledge of wind effects on pedestrians. These investigations along with suggested criteria for acceptance have been summarized by Penwarden and Wise (4). The Beaufort scale, based on mean velocity only, is reproduced as Table 4 including qualitative descriptions of wind effects. Table 4 suggests that mean wind speeds below 12 mph are of minor concern and that mean speeds above 24 mph are definitely inconvenient. Included in Section 5.2 is an analysis of the percent of time that the 12 and 24 mph magnitude are exceeded by mean winds and implications for pedestrian comfort.

The peak gust values require a somewhat different interpretation. The peak gust curves shown in Figure 9 are the percent of time during which a short gust of the stated magnitude could occur (say less than one of these gusts per hour). Evidence suggests that gusts greater than about 35 mph in magnitude can be a major impediment to pedestrians, particularly the elderly. Most measuring locations experience winds in which gusts of 35 mph or higher occur much less frequently than the 24 mph mean winds. Implications of these data are presented in Section 5.2.

Because some pedestrian wind measuring positions are purposely chosen at sites where the smoke tests showed large velocities of small spacial extent, the general wind environment about the structure may be less severe than one might infer from a strict analysis of Table 2 and Figure 9.

4.3 Pressures

For each of the pressure taps examined at each wind direction, the data record is analyzed to obtain four separate pressure coefficients. The first is the mean pressure coefficient

$$C_{p_{\text{mean}}} = \frac{(p-p_{\infty})_{\text{mean}}}{0.5 \rho U_{\infty}^2}$$

where the symbols are as defined in the List of Symbols. It represents the mean of the instantaneous pressure difference between the building pressure tap and the static pressure in the wind tunnel above the building model, nondimensionalized by the dynamic pressure

$$0.5 \rho U_{\infty}^2$$

at the reference velocity position. This relationship produces a dimensionless coefficient which indicates that the mean pressure difference between building and ambient wind at a given point on the structure is some fraction less or some fraction greater than the undisturbed wind dynamic pressure near the upper edge of the boundary layer. Using the measured coefficient, prototype mean pressure values for any wind velocity may then be calculated.

The magnitude of the fluctuating pressure is obtained by the rms pressure coefficient

$$C_{p_{\text{rms}}} = \frac{\left((p-p_{\infty}) - (p-p_{\infty})_{\text{mean}} \right)_{\text{rms}}}{0.5 \rho U_{\infty}^2}$$

in which the numerator is the root-mean-square of the instantaneous pressure difference about the mean.

If the pressure fluctuations followed a Gaussian probability distribution, no additional data would be required to predict the

frequency with which any given pressure level would be observed. However, the pressure fluctuations do not follow a Gaussian probability distribution so that additional information is required to show the extreme values of pressure expected. The peak maximum and peak minimum pressure coefficients are used to determine these values:

$$C_{P_{\max}} = \frac{(p-p_{\infty})_{\max}}{0.5 \rho U_{\infty}^2}$$

$$C_{P_{\min}} = \frac{(p-p_{\infty})_{\min}}{0.5 \rho U_{\infty}^2}$$

The values of $p-p_{\infty}$ which were digitized at 250 samples per second for 16 seconds, representing about one hour of time in the full scale, are examined individually by the computer to obtain the most positive and most negative values during the 16 second period. These are converted to $C_{P_{\max}}$ and $C_{P_{\min}}$ by nondimensionalizing with the free stream dynamic pressure.

The four pressure coefficients are calculated by the on-line data acquisition system computer and tabulated along with the approach wind azimuth in degrees from true north. The list of coefficients is included as Appendix A. The pressure tap code numbers used in the appendix are explained in Figure 3.

To determine the largest peak loads acting at any point on the structure for cladding design purposes, the pressure coefficients for all wind directions were searched to obtain, at each pressure tap, the largest absolute value of peak pressure coefficient. Table 6 provides these pressure coefficients and associated wind directions. Included in

Section 5.3 is an analysis of the coefficients of Table 6 including the maximum values obtained and where they occurred on the building.

The pressure coefficients of Table 6 can be converted to full-scale loads by multiplication by a suitable reference pressure selected for the field site. This reference pressure is represented in the equations for pressure coefficients by the $0.5 \rho U_{\infty}^2$ denominator. This value is the dynamic pressure associated with an hourly mean wind at the reference velocity measurement position at the edge of the boundary layer. In general, the method of arriving at a design reference pressure for a particular site involves selection of a design wind velocity, translation of the velocity to an hourly mean wind at the reference velocity location and conversion to a reference pressure. Selection of the design velocity can be made from statistical analysis of extreme wind data or selected from wind maps contained in the proposed wind loading code ANSI A58.1 of the American National Standards Institute (5). The calculation of reference pressure for this study is shown in Table 5. The factor used in Table 5 to reduce gust winds to hourly mean winds is given in reference (6).

The reference pressure associated with the design hourly mean velocity at the reference velocity location can be used directly with the peak-pressure coefficients to obtain peak local design wind loads for cladding design. For glass design pressures, a glass load factor is used to account for the different duration of measured peak pressures and the one minute loading used in glass design charts. Recent research (6) indicates that the period of application of the peak pressures reported herein is about 5-10 seconds or less. If a glass design is based on these peak values, then a glass strength associated with this

duration load is indicated. If the glass design is based on some alternate load duration--say one minute--then some reduction in peak loads should be made. An estimate of a load reduction factor can be obtained from an empirical relation of glass strength as a function of load duration (8). A glass load factor of 0.73 on the reference pressure was used to convert the short 5-10 second pressure peaks to one minute loads typically cited in glass selection charts.

Local, instantaneous peak loads on the full-scale building suitable for cladding design were computed by multiplying the reference pressure of Table 5 by the peak coefficients of Table 6. Loadings appropriate for glass design were computed by multiplying the reference pressure by the peak coefficients of Table 6 with application of the 0.73 load factor. Table 6 shows both of these results. The maximum psf load given at each tap location is the absolute value of the maximum value found in the tests, irrespective of its algebraic sign. For ease in visualizing the loads on the structure, contours of equal peak pressures for glass design shown in Table 6 have been plotted on developed elevation views of the structure, Figure 10. Loads appropriate for design of mullions or other cladding elements can be obtained by using the loads of Table 6 or multiplying the loads of Figure 10 by 1.37.

5. DISCUSSION

5.1 Flow Visualization

Flow patterns about the Columbia Plaza building determined from smoke visualization did not show any flows characteristic of exceptionally high local pressures. A vortex on the north face of the building with its origin at the point where the pedestal structure meets the north face was observed for an east-southeast range of wind directions. The vortex did not, however, appear to be sufficiently tightly wound to cause greatly elevated local pressures in that region. Surface wind velocities in pedestrian areas appeared to be moderate except possibly at the northwest corner of the building (17th and Broadway streets) where velocities were high for some wind directions. The main entrance and plaza on Broadway appeared to have low wind speeds for almost all directions.

5.2 Pedestrian Winds

As shown in Figure 4, data was obtained at pedestrian location 1 at 18th and Broadway for comparative purposes. In addition, data for locations 14-16 were obtained at the same locations as 7, 10 and 11 but with the Columbia Plaza building removed. Table 2 and Figure 8 show that the largest mean velocities measured occurred at location 10 for wind azimuths of 22, 45 and 67 degrees. Mean wind speeds of 69, 68 and 66 percent of the reference velocity U_{∞} at 1250 ft were measured. Location 10 also showed large mean velocities for winds from 202, 225 and 247 degrees azimuth. Comparison with data at location 15 (the same location as 10 without the building in place) shows that the high velocities at location 10 are due primarily to the Columbia Plaza building.

The largest value of fluctuating velocity, $U_{\text{rms}}/U_{\infty}$, was found at location 9 at 135 degrees wind azimuth. The root-mean-square value was 20 percent of U_{∞} . All locations experienced rather low values of fluctuating velocity. The largest values of 'gustiness', U_{rms}/U , were above 100 percent. Because these large values of gustiness were associated with low mean velocities, they are not necessarily associated with uncomfortable environments.

Velocity data integrated with local wind data is shown in Figure 9. Mean winds will be above 12 mph, the level where wind effects become significant, for about 10 percent of the time at location 10 and less than 4 percent at all other locations. Some locations near the entrance on Broadway will seldom experience mean winds above 12 mph. Location 10 will experience mean winds above 24 mph about 0.8 percent of the time. Other locations have percentages less than 0.2 percent.

The largest percentage of time when peak gusts are likely to be greater than 24 mph occurs at location 10 with 6 percent. This is approximately twice the percentage at that location without the building in place. Most locations showed percentages of 2 percent or less. The percentage of time when gust speeds are likely to exceed the 35 mph value is about 1 percent at location 10 and less for other locations.

In general, the pedestrian winds about the Columbia Plaza building are low, especially in the plaza area near the main entrance on Broadway. The worst location is on the sidewalk at the northwest corner of the building at 17th and Broadway. Winds at that location will be unpleasant on windy days when winds are from the northeast and southwest. Remedial measures are not likely to be needed.

5.3 Pressures

Table 6 shows the largest pressure coefficients and loads measured on the building. The largest pressure coefficient measured was -2.96 at tap 209 on the rounded corner of the building for wind azimuth 75. About 7 percent of the taps showed coefficients above 2.0. Most coefficients were rather moderate. The 2.96 pressure coefficient corresponds to a glass load of 59 psf using the reference pressure of Table 5 for a 50-year recurrence wind. The pressure data confirmed the flow visualization study which found no areas of excessively high pressures.

REFERENCES

1. Cermak, J. E., "Laboratory Simulation of the Atmospheric Boundary Layer," AIAA Jl., Vol. 9, September 1971.
2. Cermak, J. E., "Applications of Fluid Mechanics to Wind Engineering," A Freeman Scholar Lecture, ASME Jl. of Fluids Engineering, Vol. 97, No. 1, March 1975.
3. Cermak, J. E., "Aerodynamics of Buildings," Annual Review of Fluid Mechanics, Vol. 8, 1976, pp. 75-106.
4. Penwarden, A. D., and Wise, A. F. E., "Wind Environment Around Buildings," Building Research Establishment Report, HMSO, 1975.
5. American National Standards Institute, "American National Standard Building Code Requirements for Minimum Design Loads in Buildings and Other Structures," ANSI Standard A58.1, 1972.
6. Vellozzi, J., and Cohen, C., "Gust Response Factors," Jl. Structural Div., ASCE, Proc. Paper No. 5980, Vol. 94, No. ST6, 1968.
7. Peterka, J. A., and Cermak, J. E., "Peak-Pressure Duration in Separated Regions on a Structure," U.S.-Japan Research Seminar on Wind Effects on Structures, Kyoto, Japan, 9-13 September 1974; Report CEP74-75JAP-JEC8, Fluid Mechanics Program, Colorado State University, September 1974.
8. Architectural Glass Products, Pittsburgh Plate Glass Industries, January 1975.

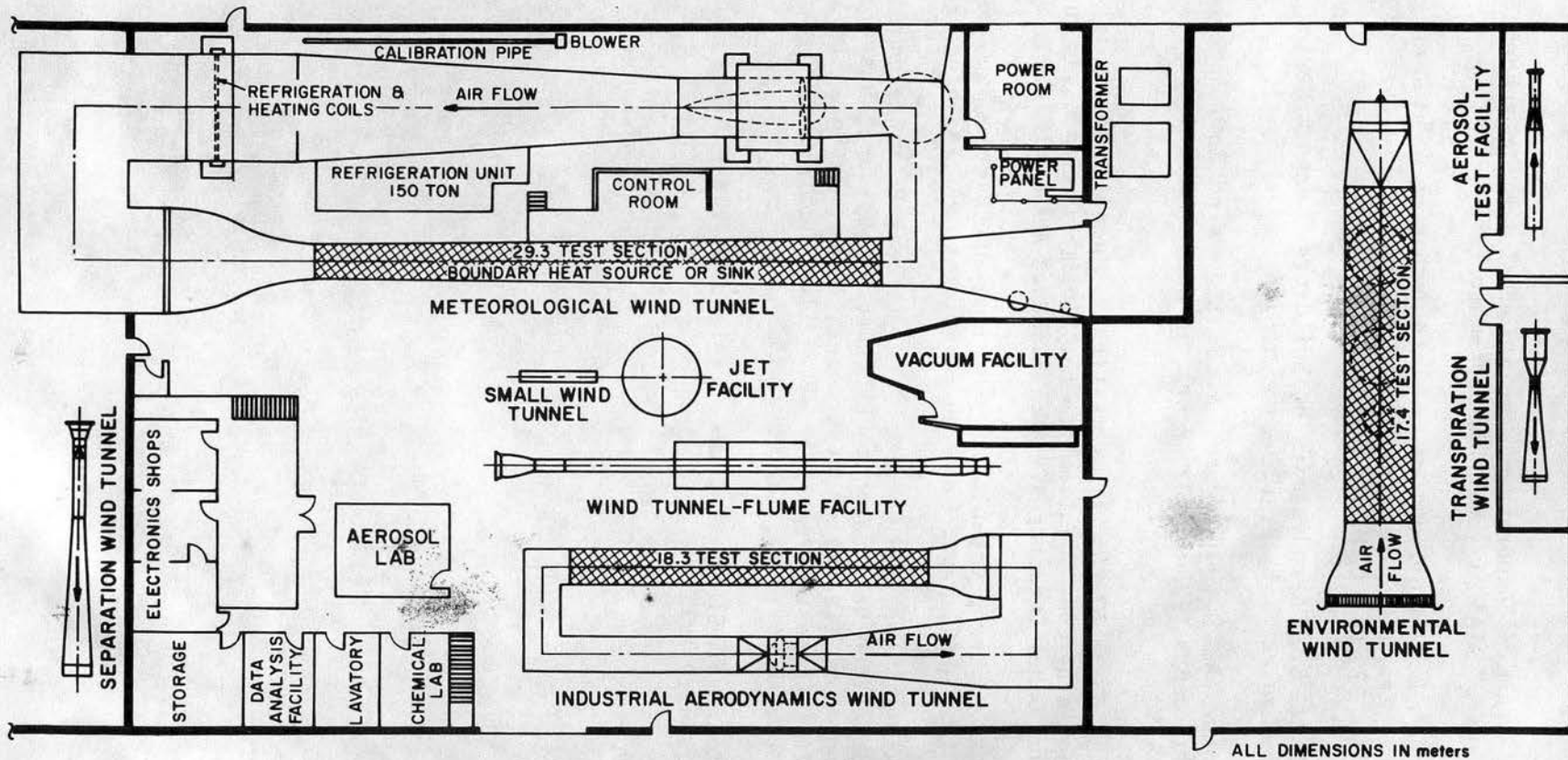

**FIGURE 1 - FLUID DYNAMICS AND DIFFUSION LABORATORY
COLORADO STATE UNIVERSITY**

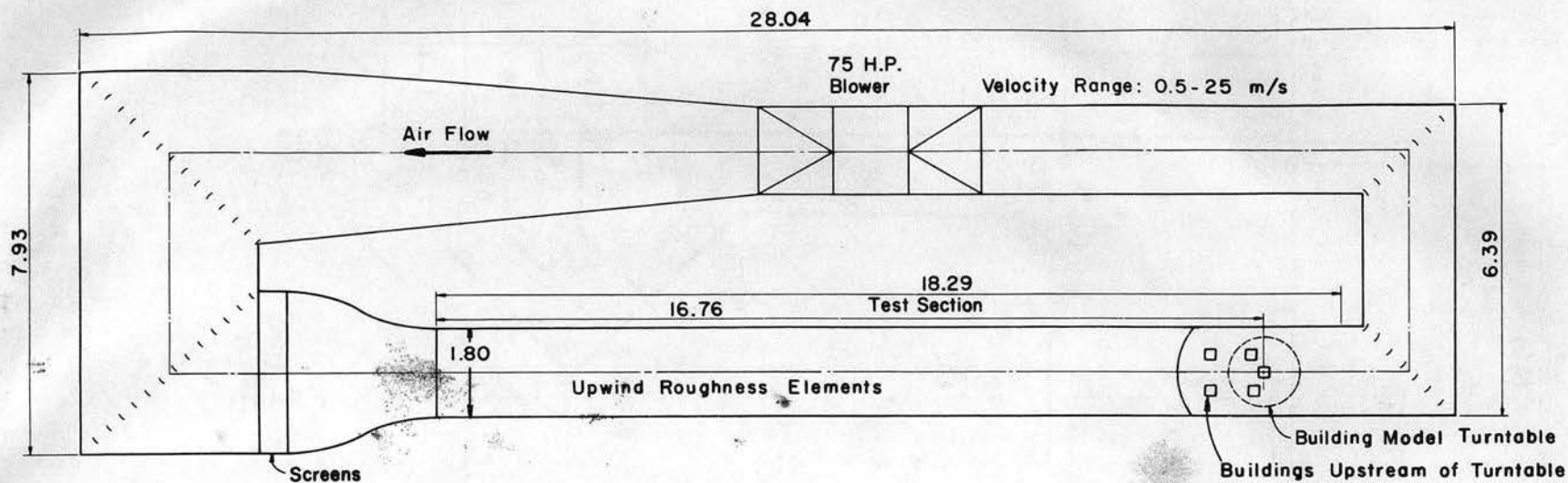

PLAN

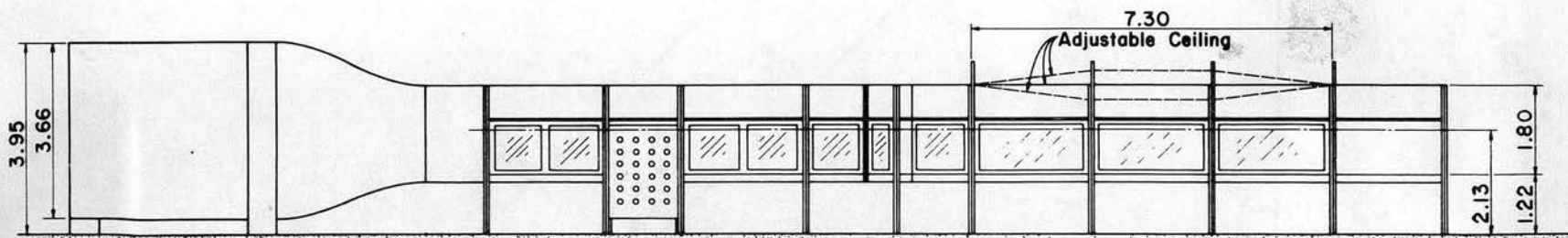
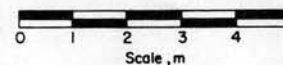

All Dimensions in m

ELEVATION

INDUSTRIAL AERODYNAMICS WIND TUNNEL

Figure 2 - Wind Tunnel Configuration

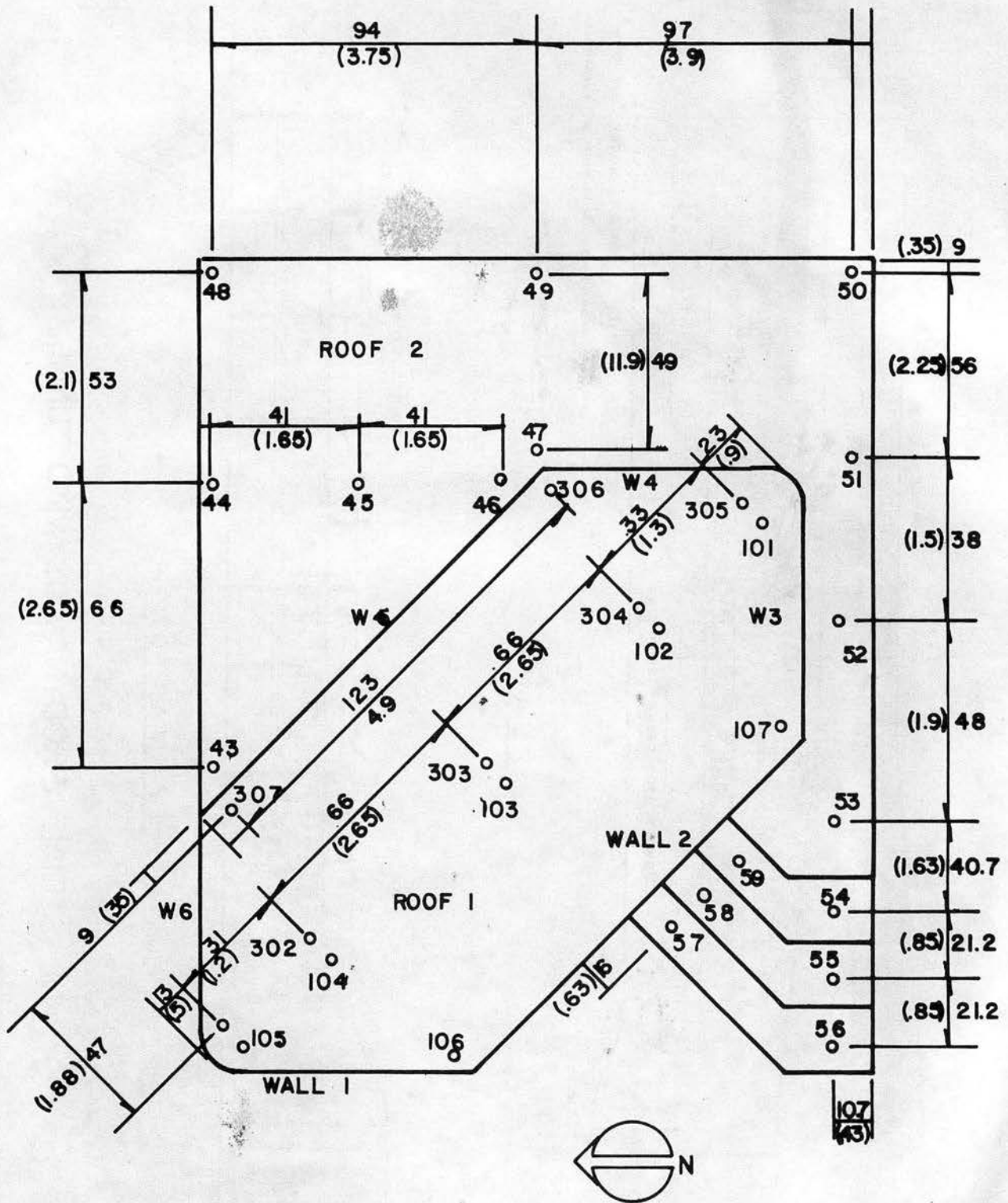

MODEL SCALE - 1/300

TOTAL TAPS - 315

Figure 3a. Pressure Tap Locations

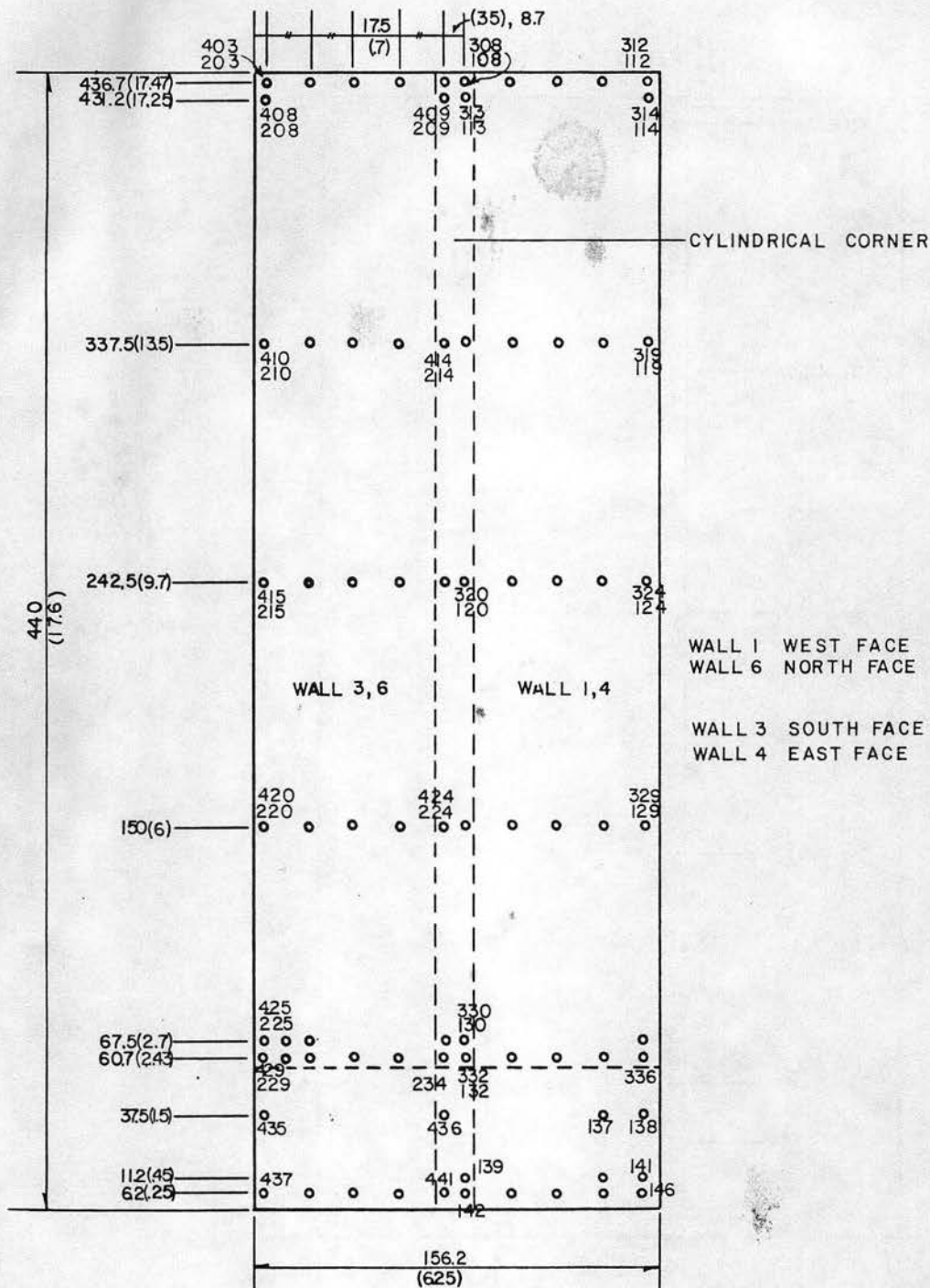

Figure 3b. Pressure Tap Locations

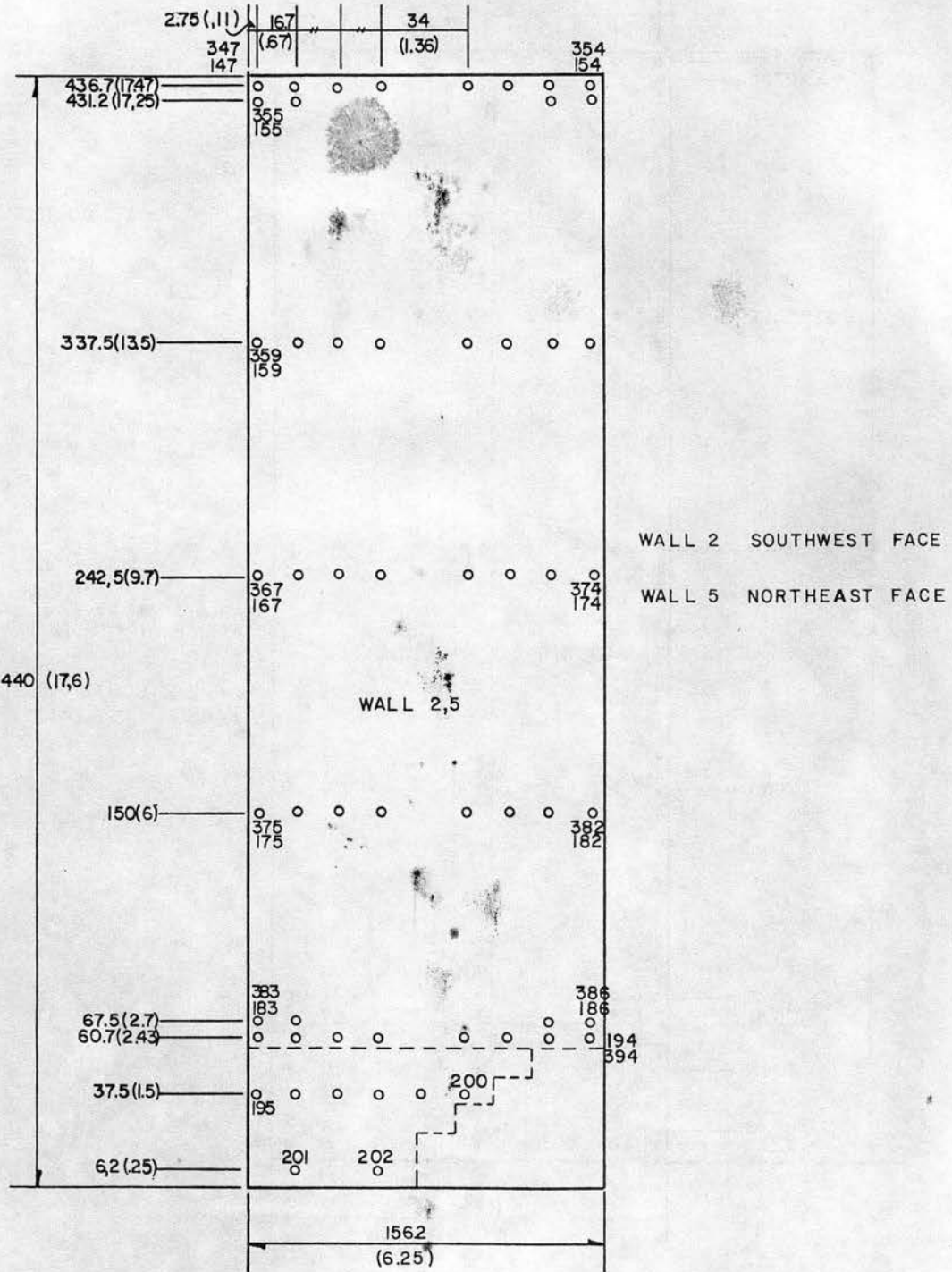

Figure 3c. Pressure Tap Locations

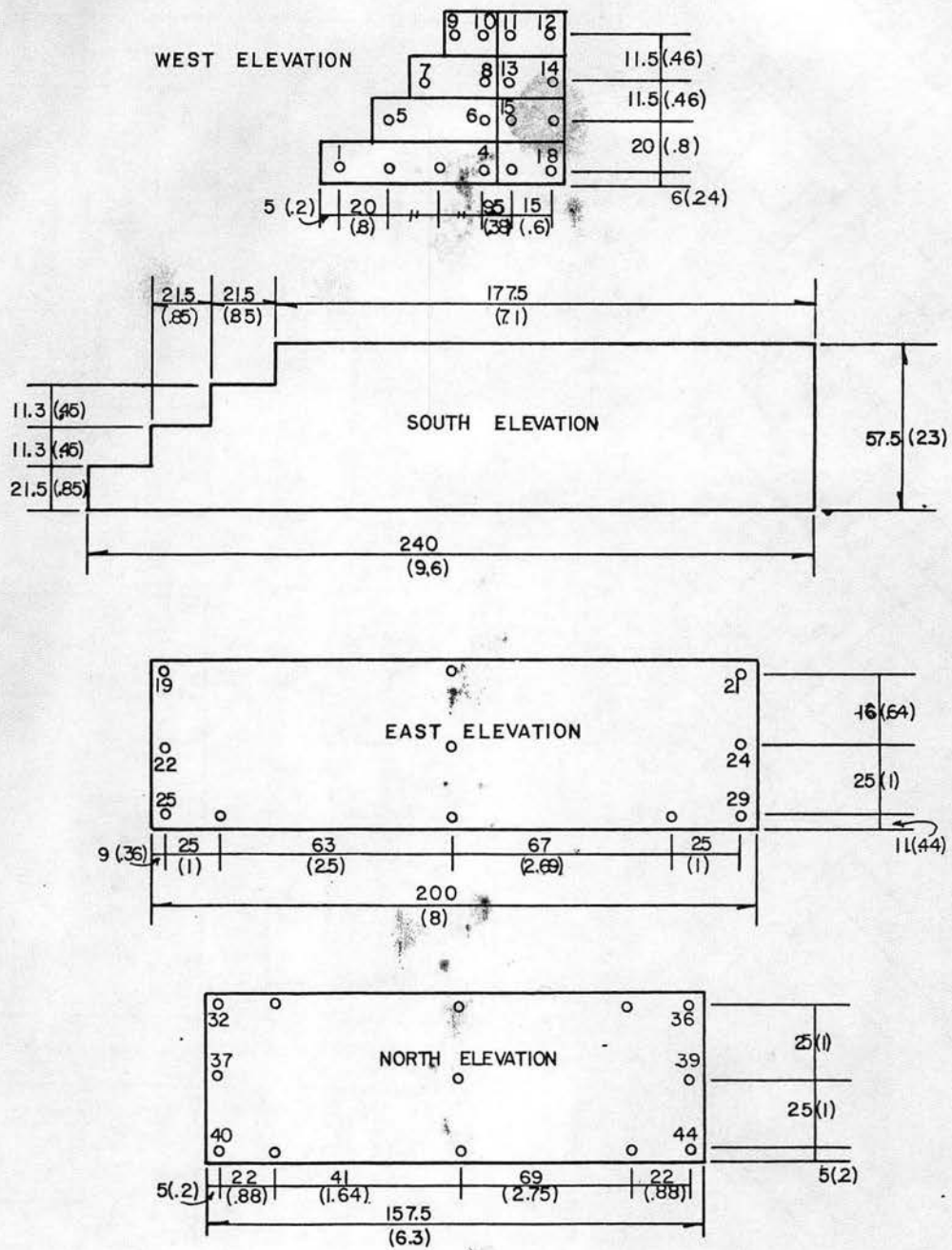
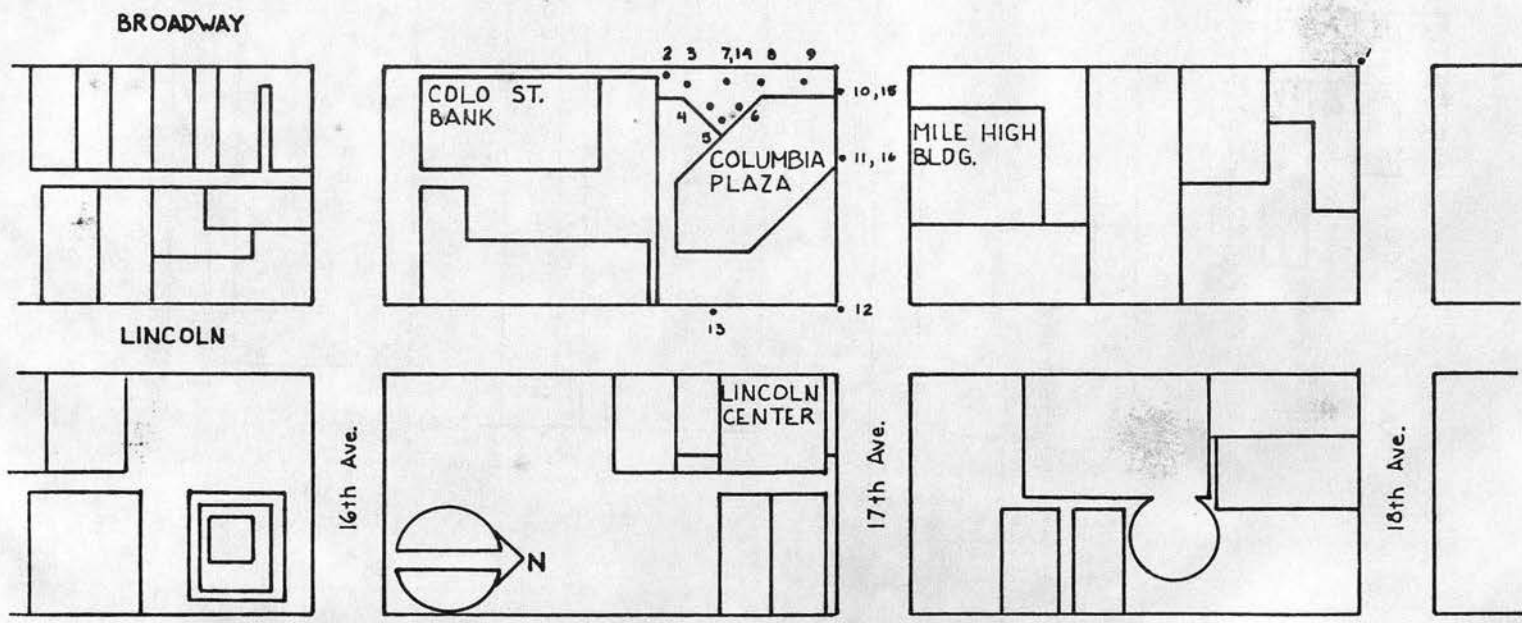
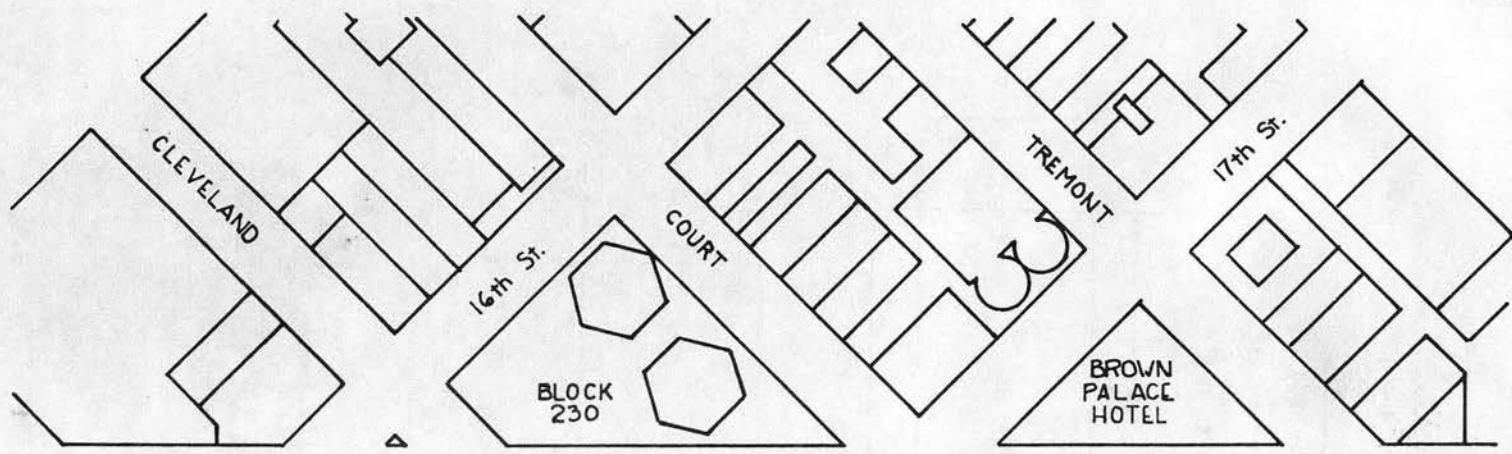

Figure 3d. Pressure Tap Locations



DATA FOR 1945, 16 TAKEN WITHOUT BLDG. IN PLACE

MODEL RADIUS \approx 1350 Ft.

Figure 4. Building Location and Pedestrian Wind Velocity Measuring Positions

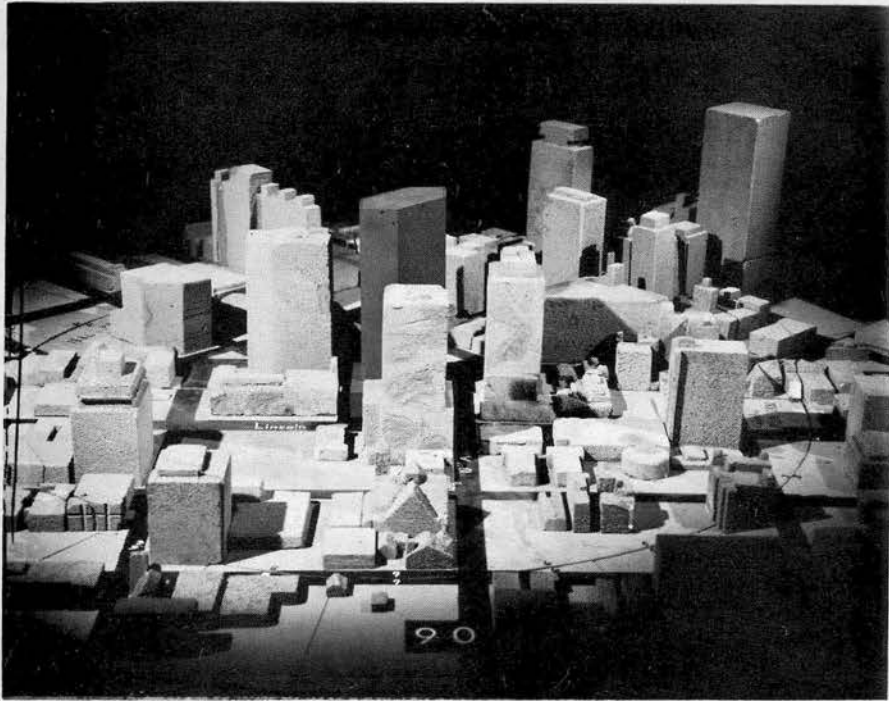

Figure 5. Completed Model in Wind Tunnel

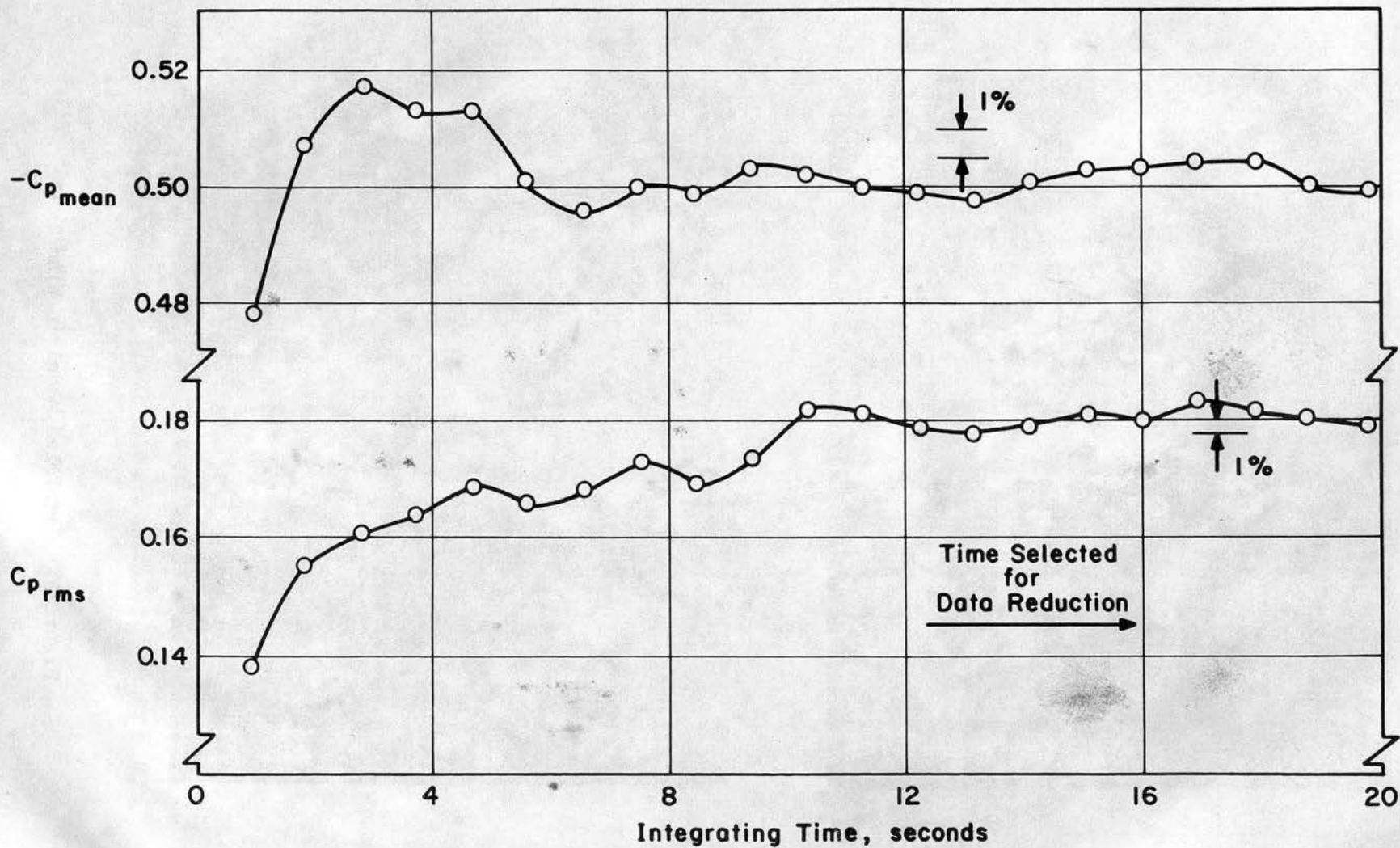

Figure 6- Data Sampling Time Verification

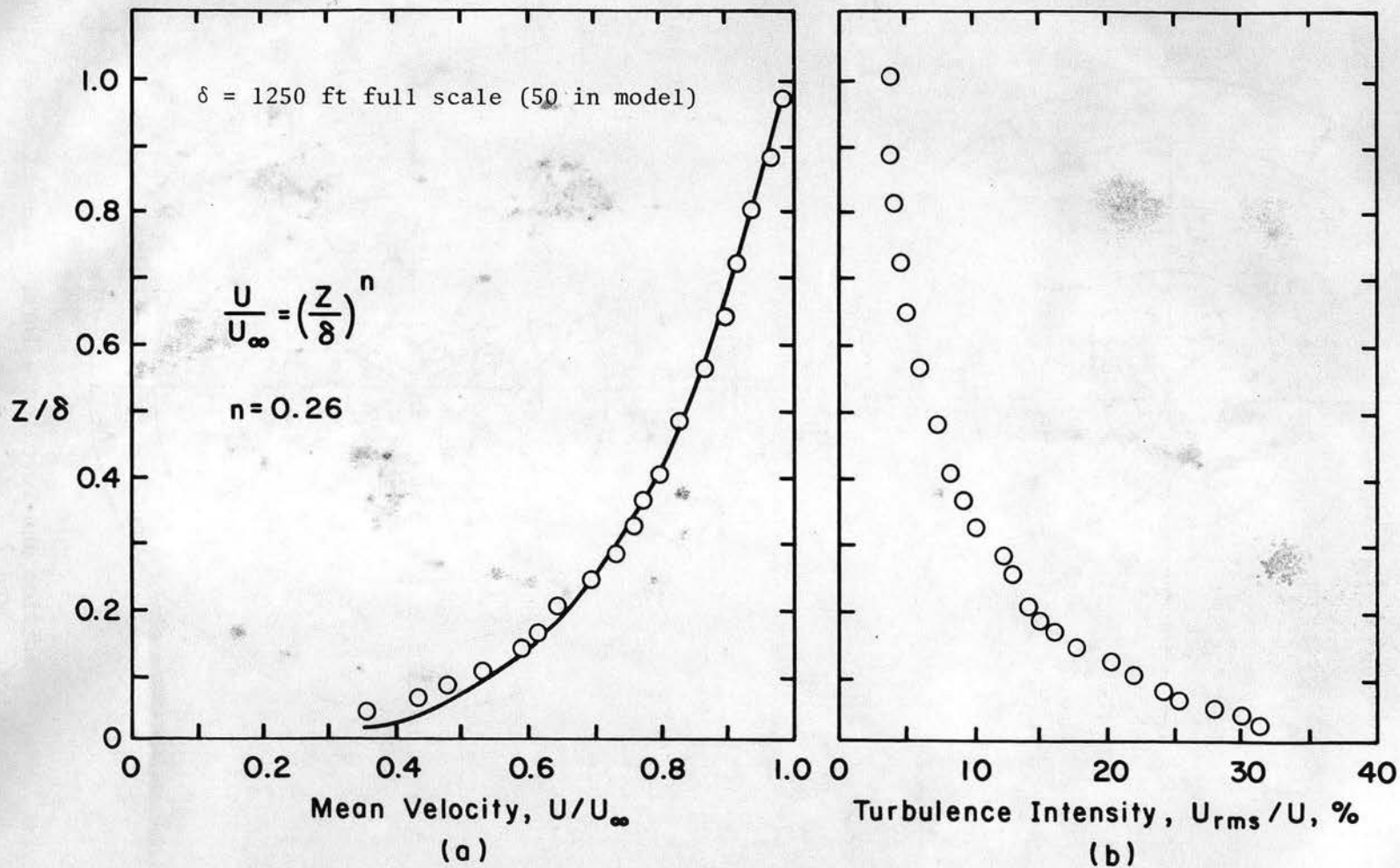

Figure 7 - Velocity and Turbulence Profiles Approaching the Model

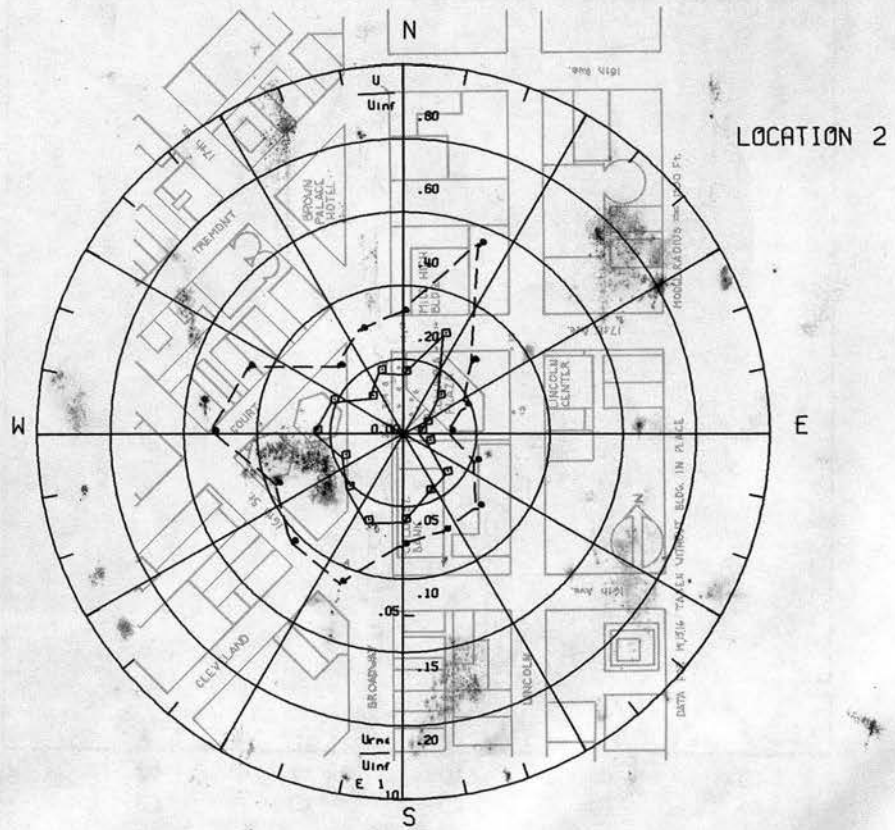
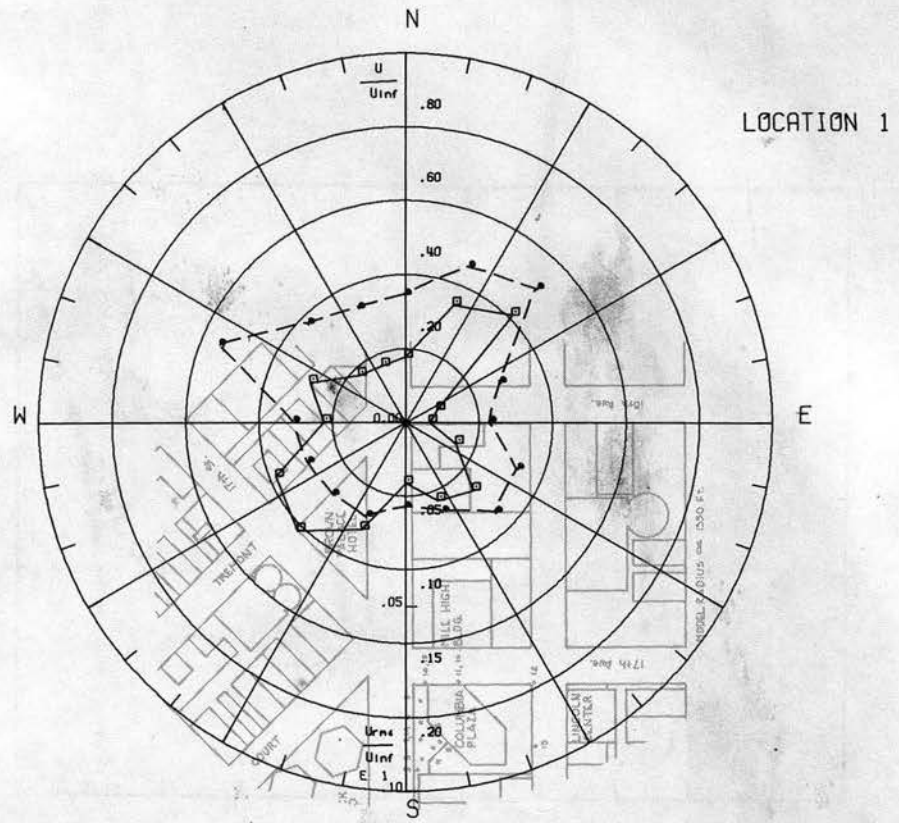

Figure 8a. Mean Velocities and Turbulence Intensities at Pedestrian Locations 1 and 2

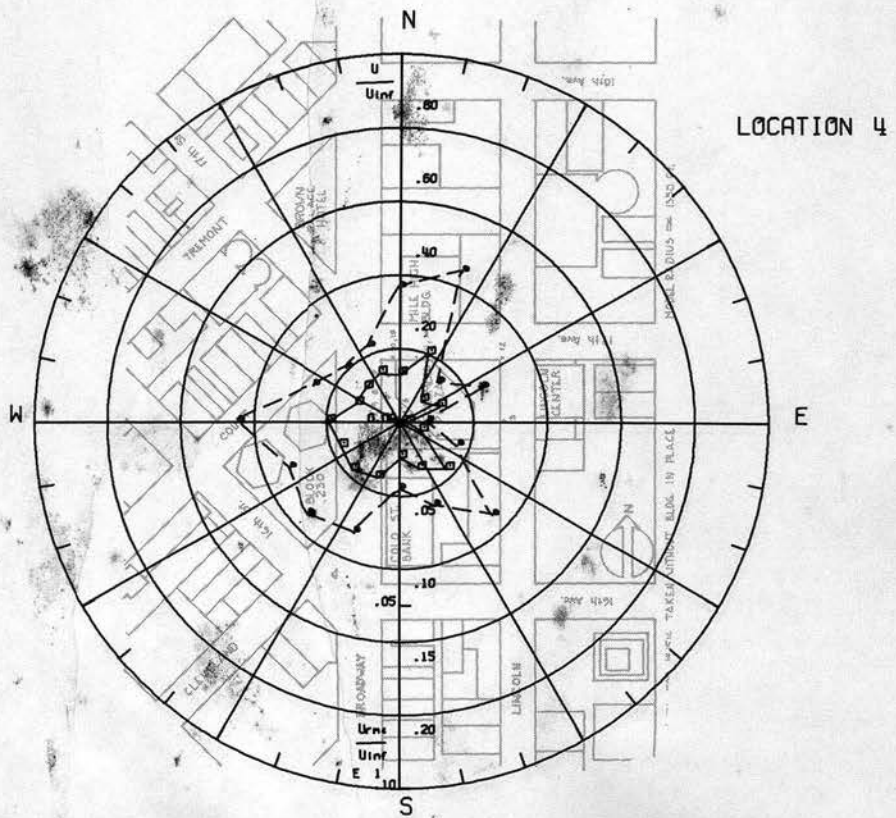
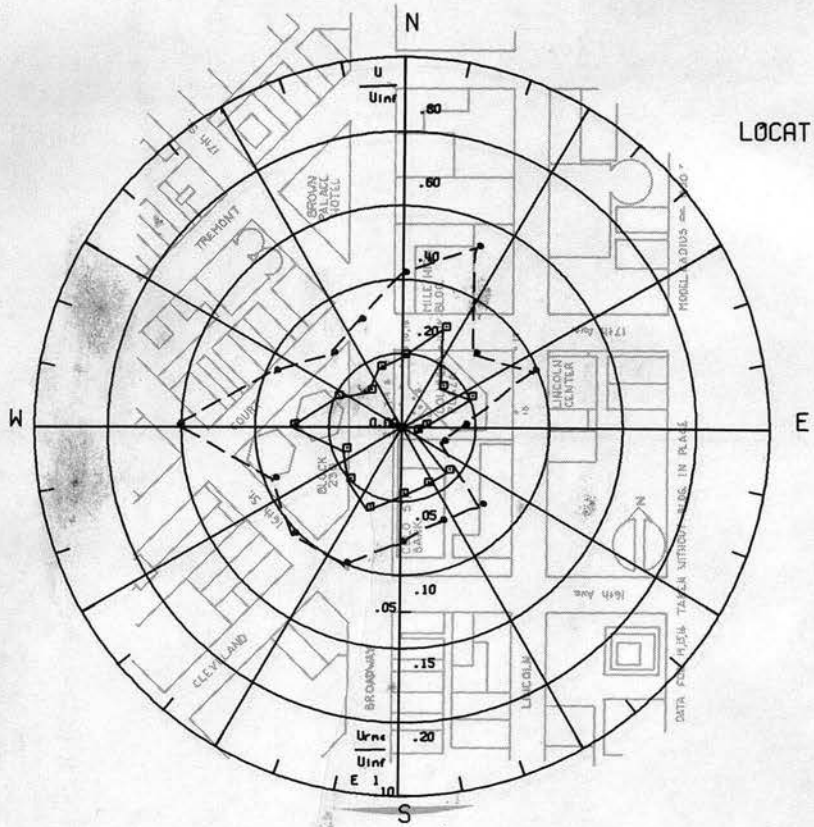

Figure 8b. Mean Velocities and Turbulence Intensities at Pedestrian Locations 3 and 4

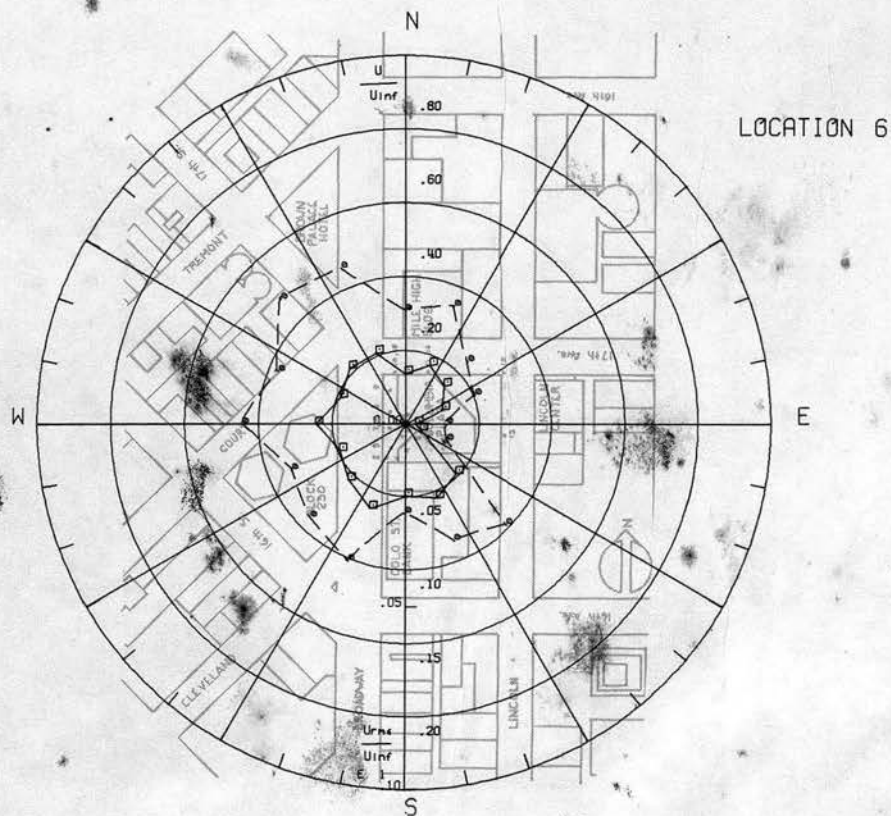
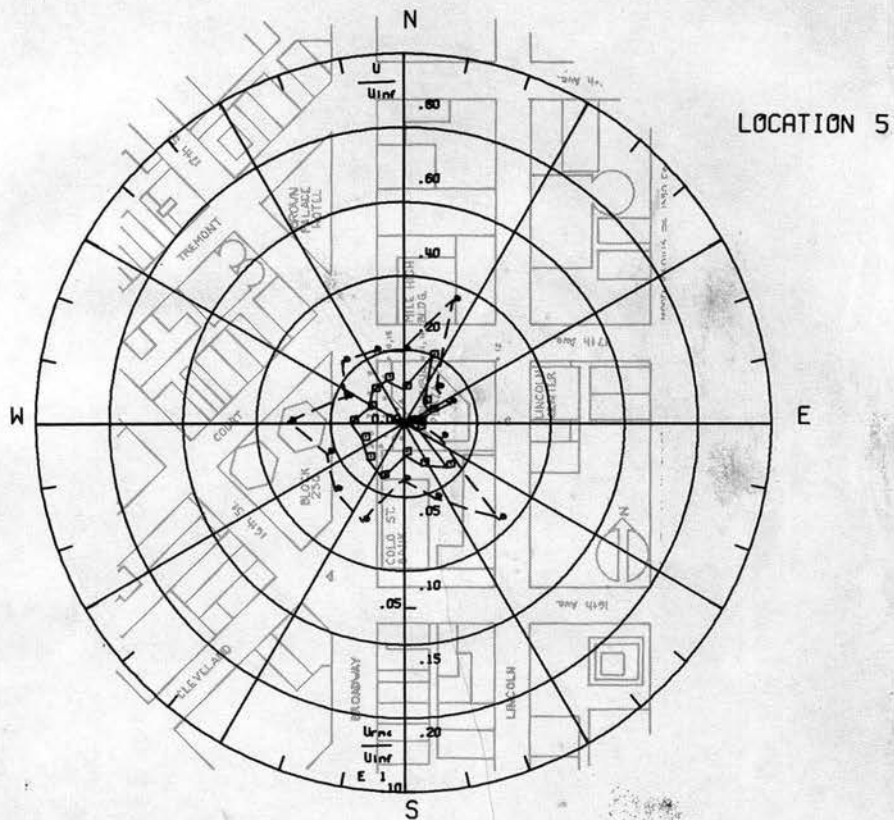

Figure 8c. Mean Velocities and Turbulence Intensities at Pedestrian Locations 5 and 6

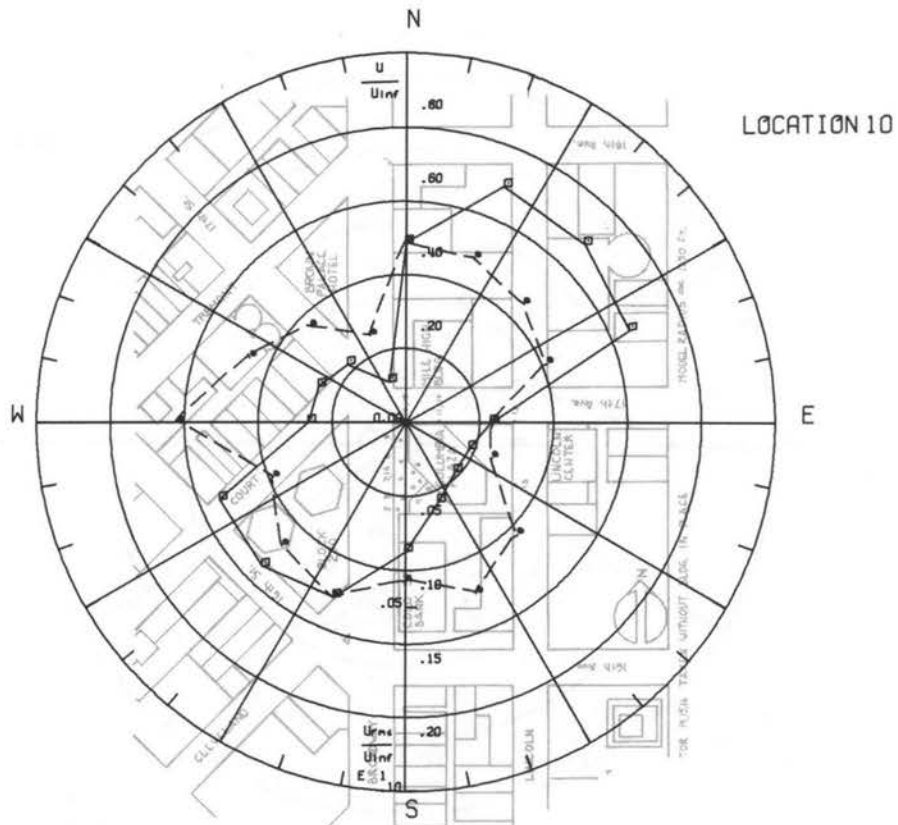
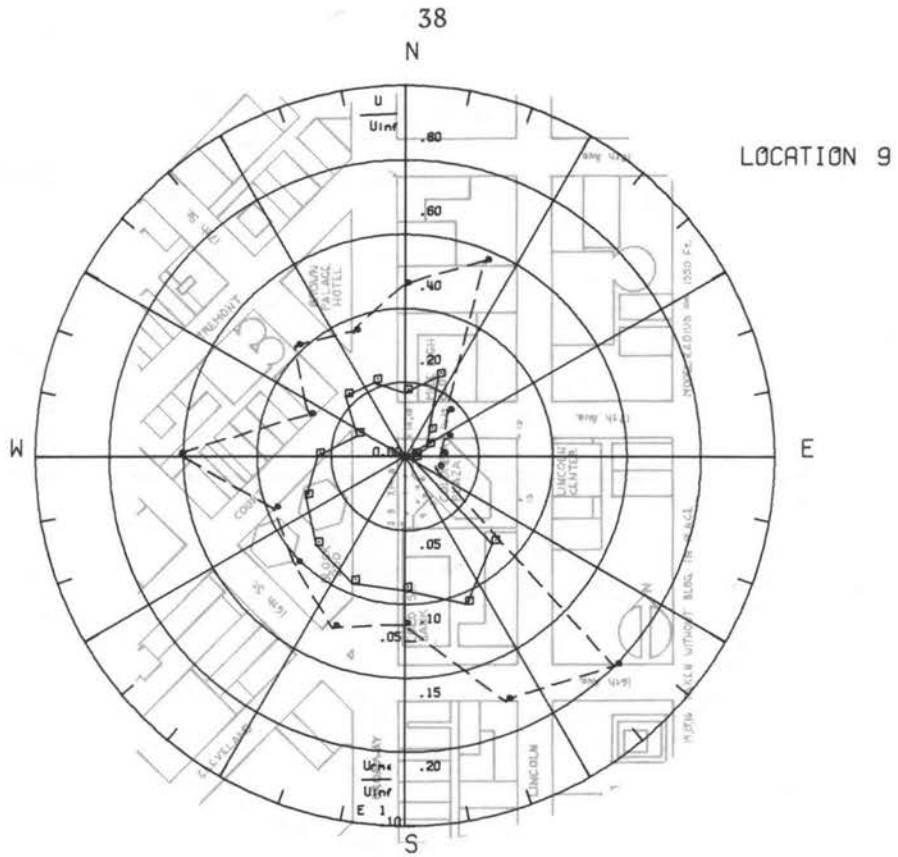

Figure 8e. Mean Velocities and Turbulence Intensities at Pedestrian Locations 9 and 10

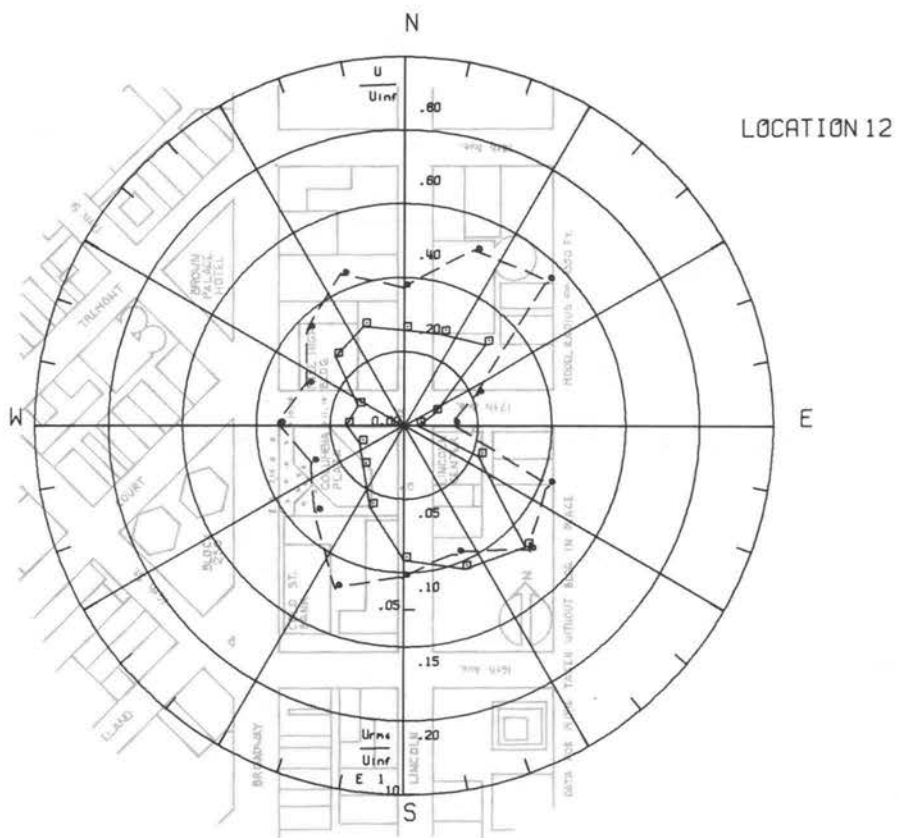
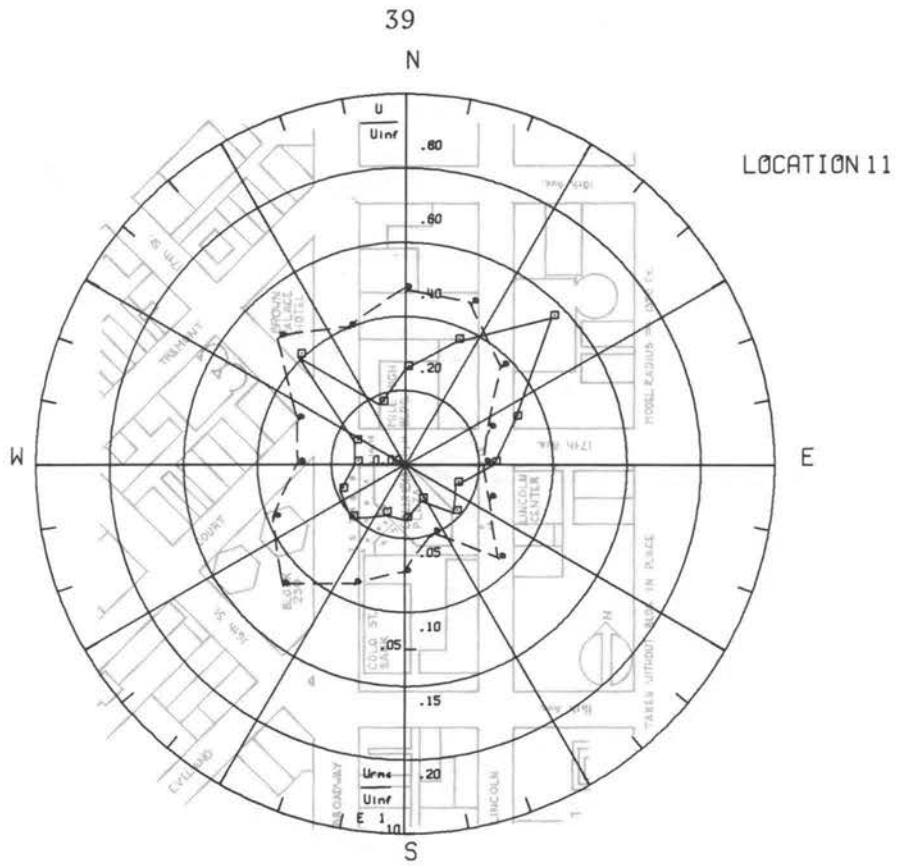

Figure 8f. Mean Velocities and Turbulence Intensities at Pedestrian Locations 11 and 12

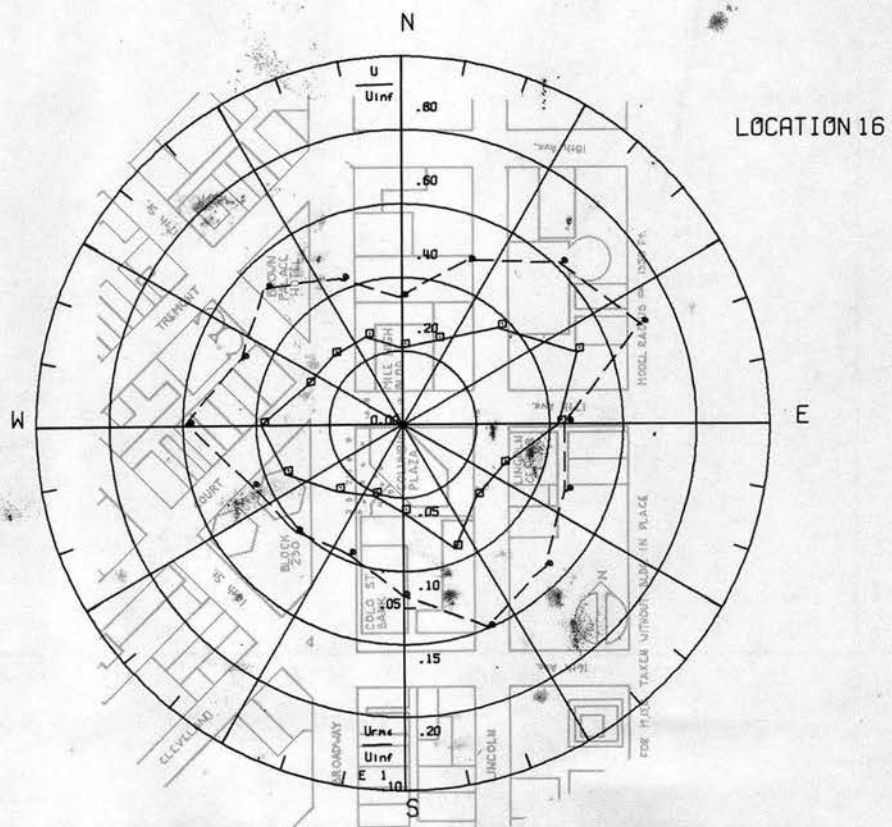
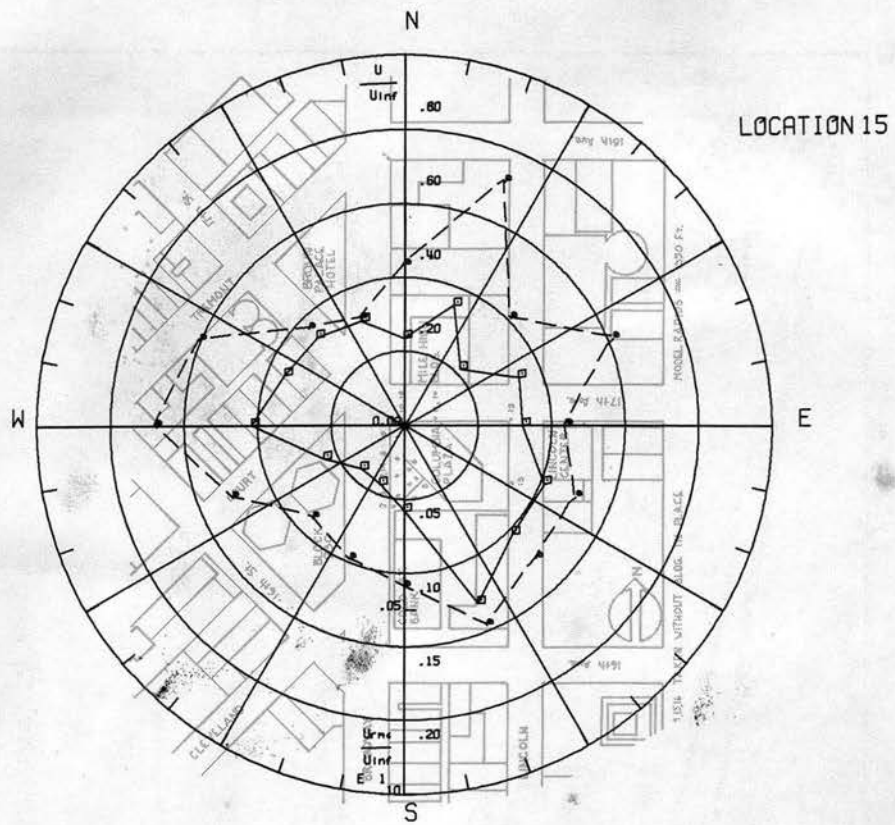

Figure 8h. Mean Velocities and Turbulence Intensities at Pedestrian Locations 15 and 16

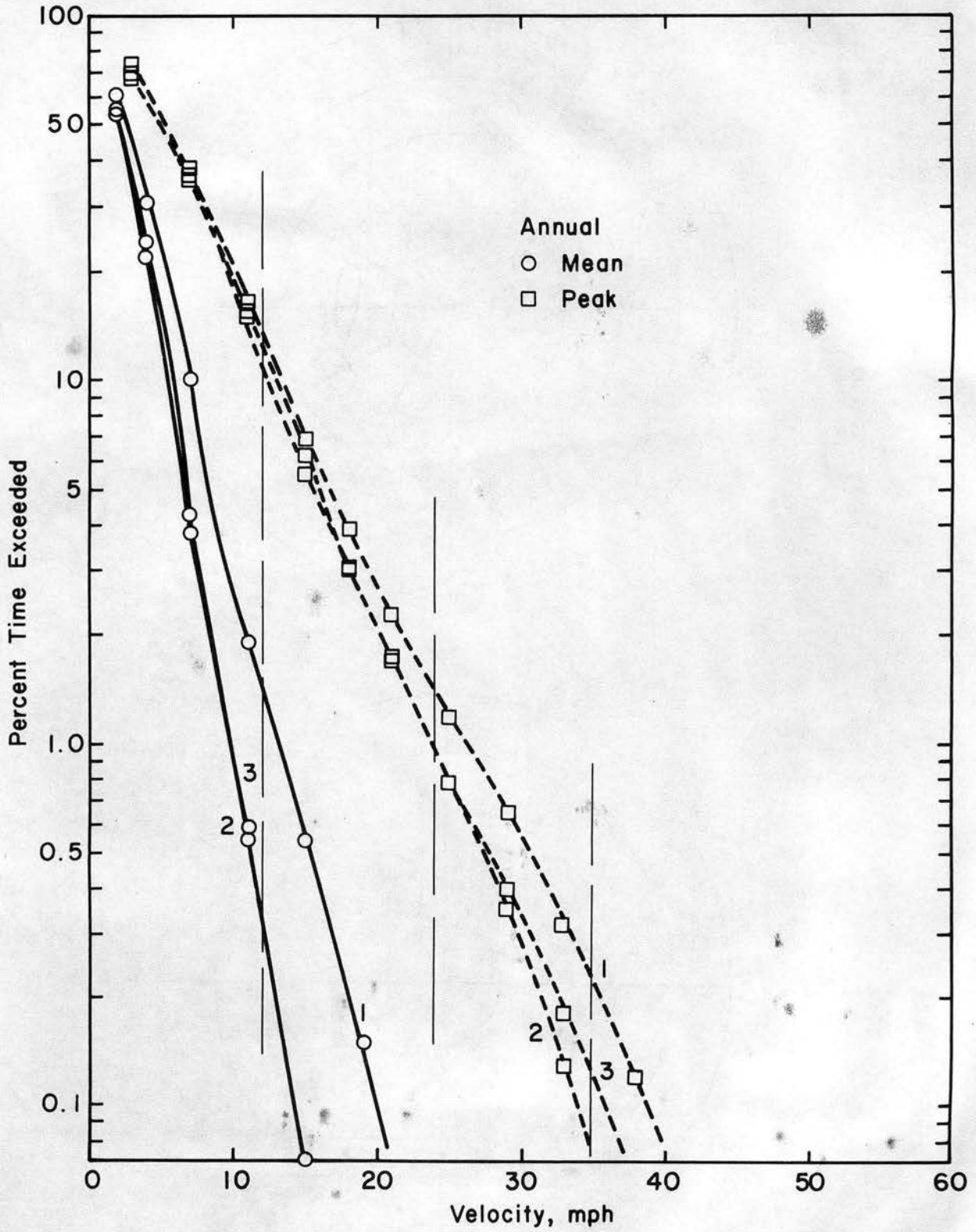

Figure 9a. Wind Velocity Probabilities for Pedestrian Locations

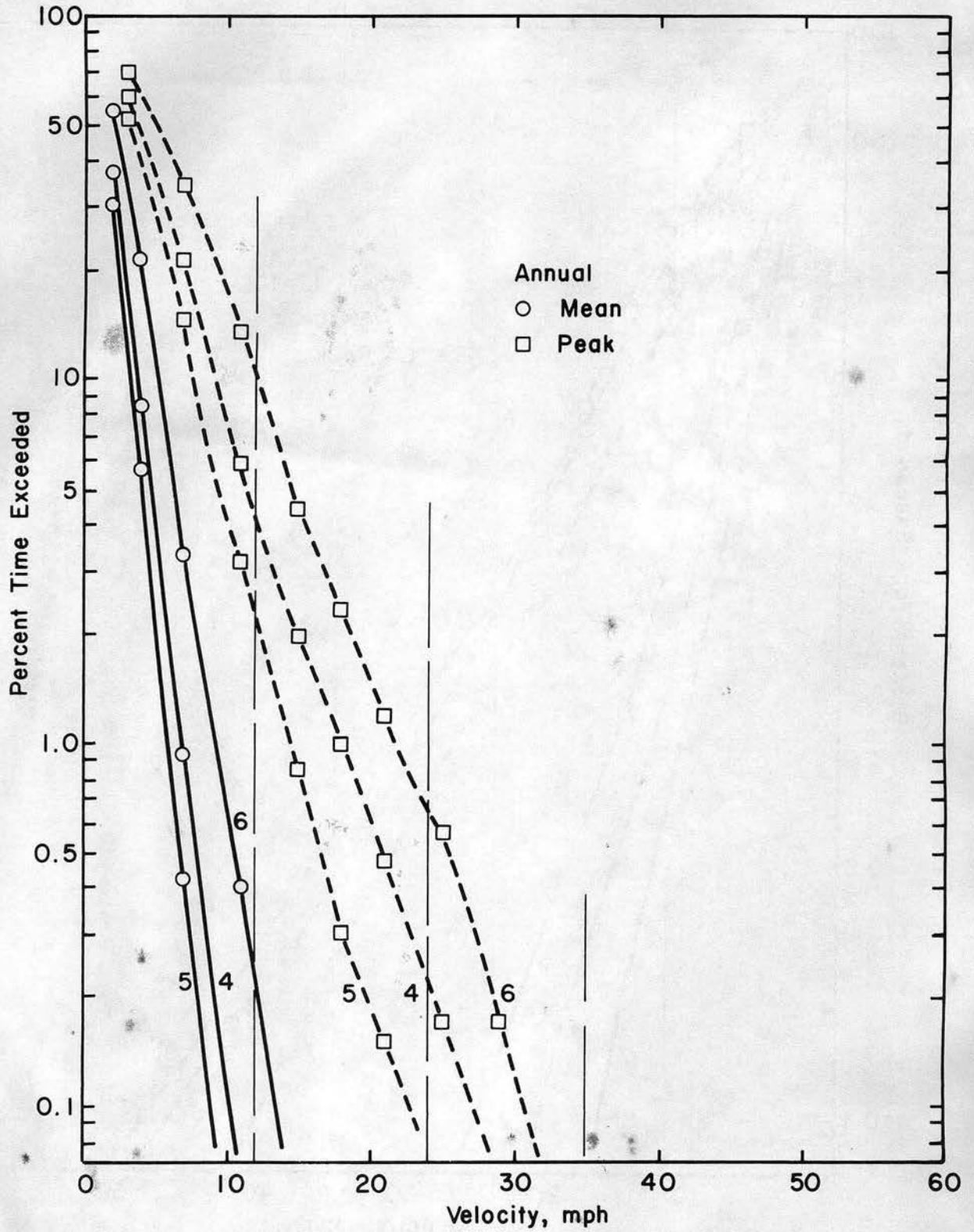

Figure 9b. Wind Velocity Probabilities for Pedestrian Locations

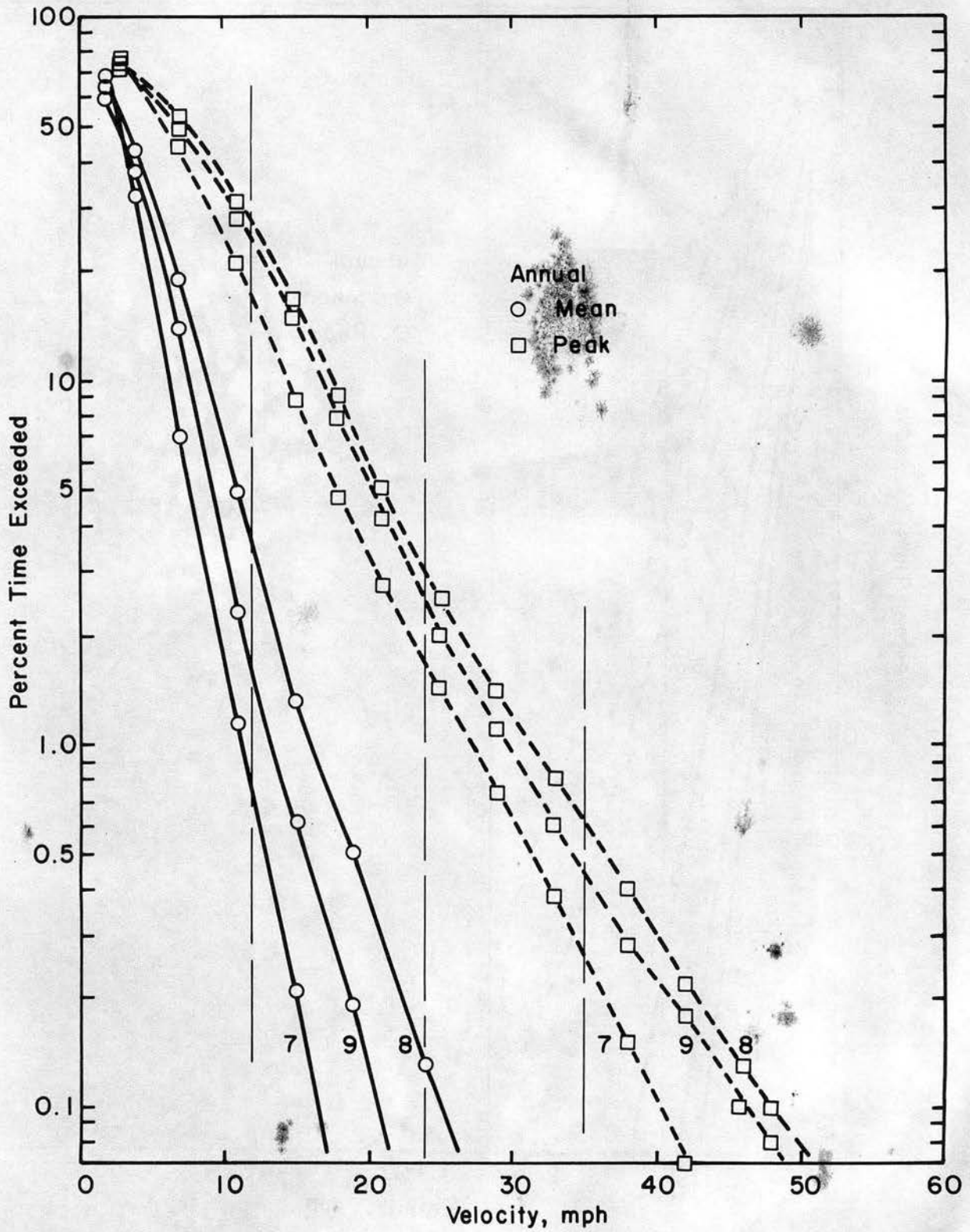

Figure 9c. Wind Velocity Probabilities for Pedestrian Locations

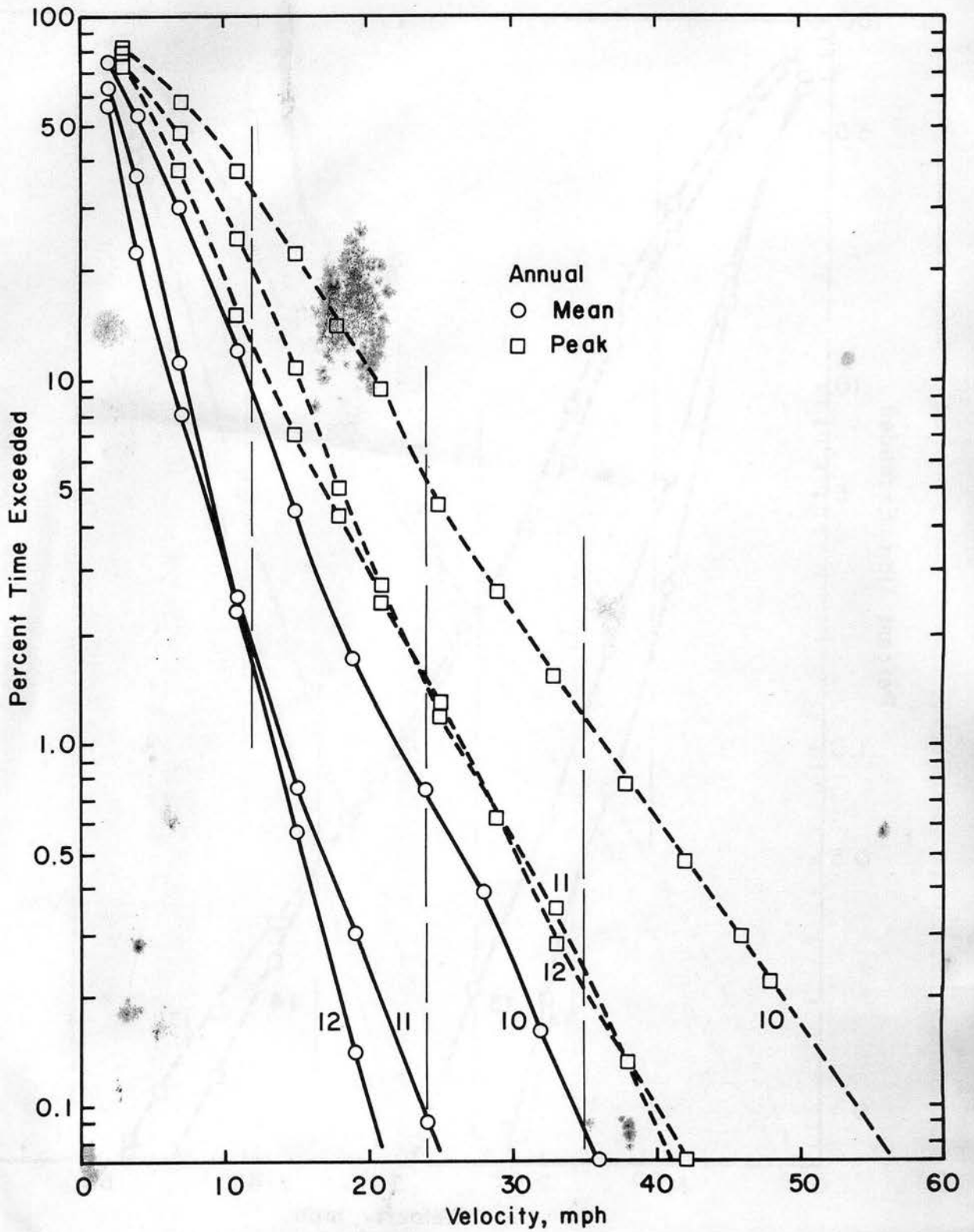

Figure 9d. Wind Velocity Probabilities for Pedestrian Locations

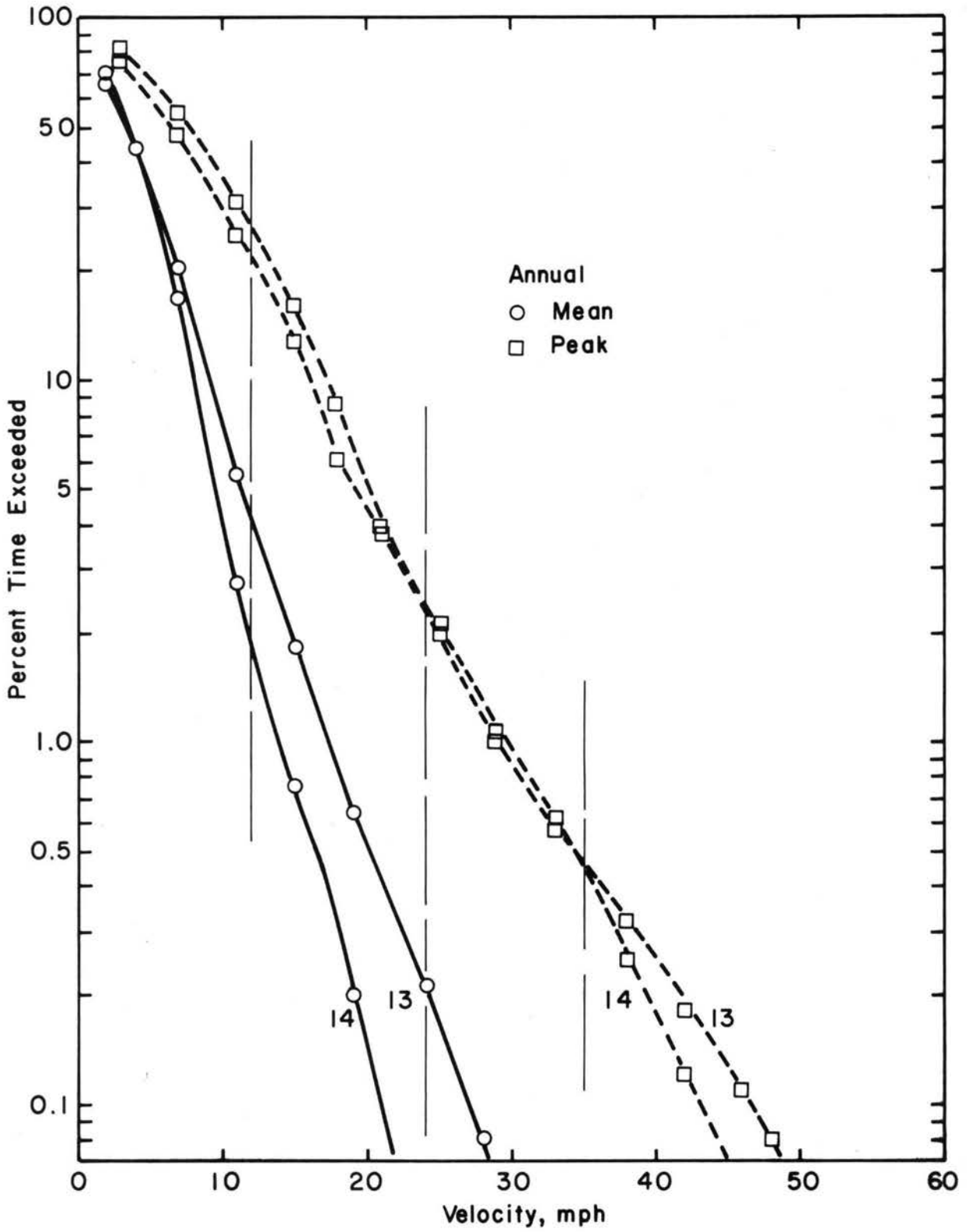

Figure 9e. Wind Velocity Probabilities for Pedestrian Locations

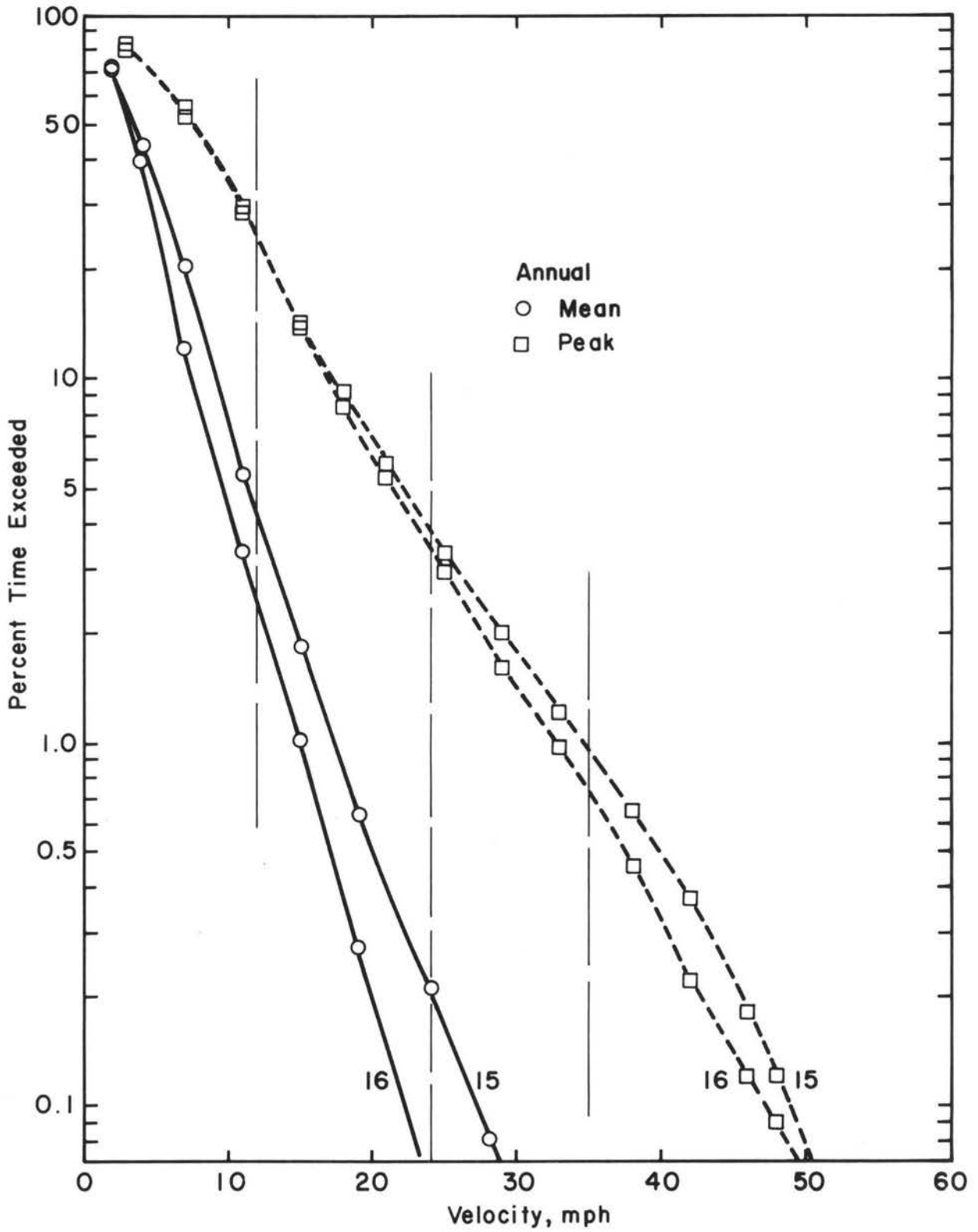
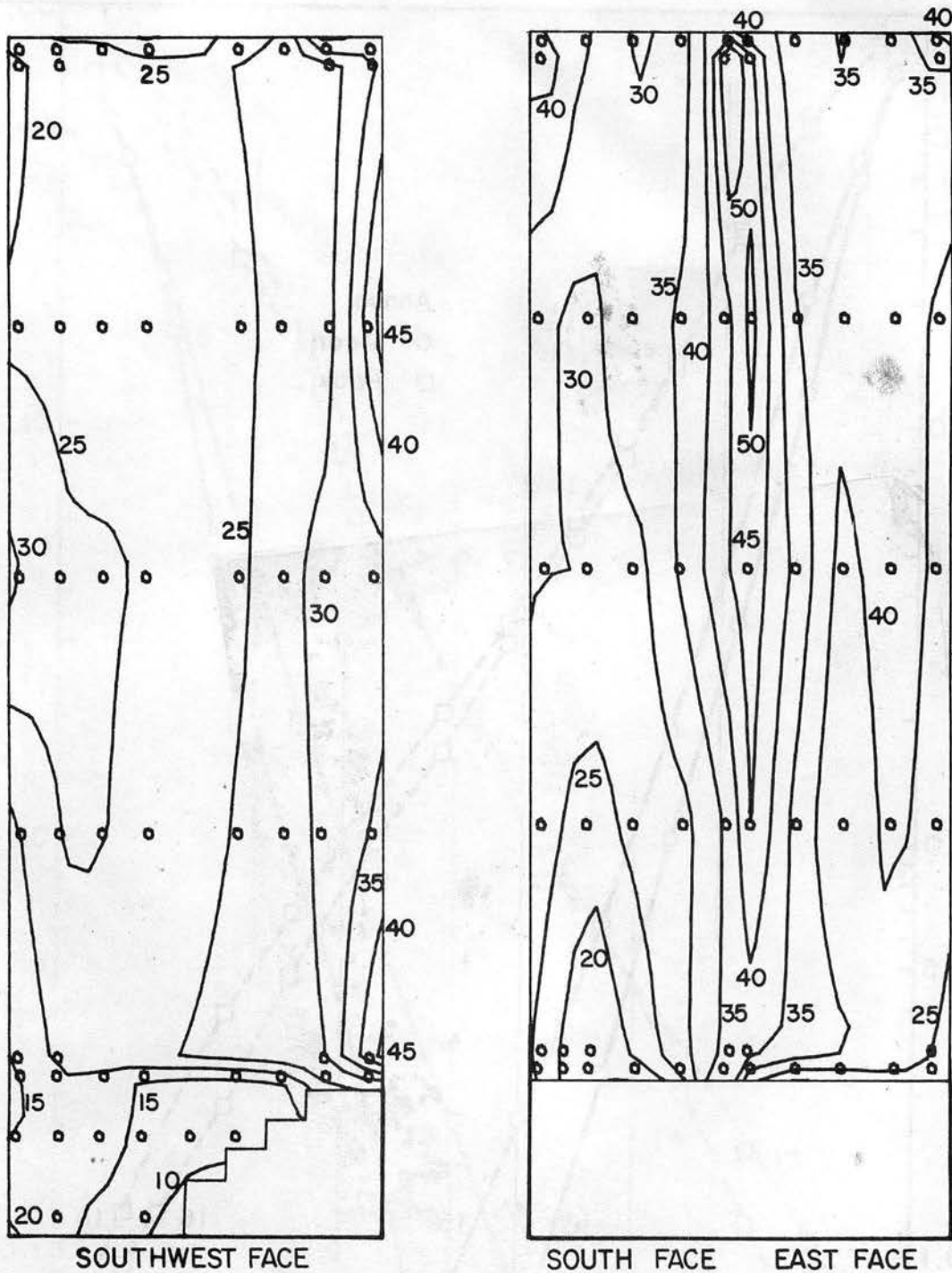
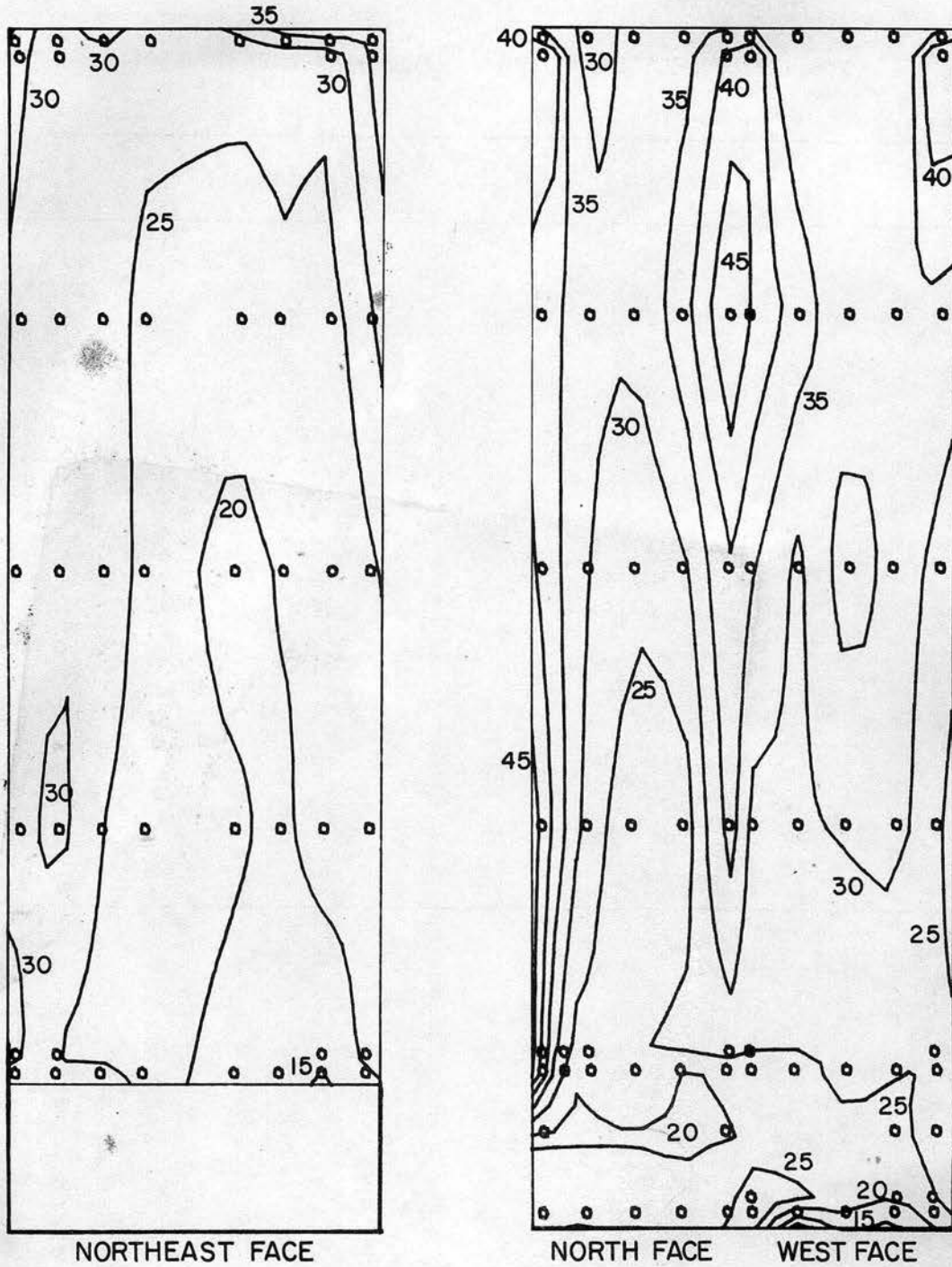

Figure 9f. Wind Velocity Probabilities for Pedestrian Locations



COLUMBIA PLAZA, DENVER
 REFERENCE PRESSURE = 28 psf
 GLASS LOAD FACTOR = 0.73

Figure 10a. Peak-Pressure Contours on the Building for Glass Loads



COLUMBIA PLAZA, DENVER
REFERENCE PRESSURE = 28 psf
GLASS LOAD FACTOR = 0.73

Figure 10b. Peak-Pressure Contours on the Building for Glass Loads

TABLE 1. MOTION PICTURE SCENE GUIDE -- COLUMBIA PLAZA

Run	Wind Azimuth
1	0°
2	45°
3	90°
4	135°
5	180°
6	225°
7	270°
8	315°

Length \approx 455 ft

Running Time \approx 13 min

TABLE 2. PEDESTRIAN WIND VELOCITIES AND TURBULENCE INTENSITIES

COLUMBIA PLAZA DENVER, COLORADO

POSITION 1				POSITION 2			
WIND AZIMUTH	U/UINF (PERCENT)	URMS/UINF (PERCENT)	URMS/U (PERCENT)	WIND AZIMUTH	U/UINF (PERCENT)	URMS/UINF (PERCENT)	URMS/U (PERCENT)
0.00	17.8	8.6	48.4	0.00	15.8	8.1	51.2
22.50	34.4	11.3	33.0	22.50	28.3	13.7	48.5
45.00	41.1	12.7	30.9	45.00	13.4	6.7	50.4
67.50	9.3	7.0	75.3	67.50	6.3	4.6	73.2
90.00	6.5	5.7	87.8	90.00	4.3	3.2	73.5
112.50	14.9	8.3	55.7	112.50	7.1	5.3	74.8
135.00	26.0	8.7	33.5	135.00	16.0	7.3	45.4
157.50	22.9	6.6	28.8	157.50	17.6	7.3	41.6
180.00	16.5	5.8	35.3	180.00	24.3	7.8	32.0
202.50	31.5	7.0	22.1	202.50	26.7	11.2	42.1
225.00	41.6	7.0	16.8	225.00	21.8	10.7	49.1
247.50	38.2	7.2	18.8	247.50	17.9	9.4	52.3
270.00	22.4	7.6	34.1	270.00	24.3	13.0	53.6
292.50	28.1	13.7	48.8	292.50	21.4	11.4	53.4
315.00	17.9	9.4	52.3	315.00	13.0	6.2	47.9
337.50	16.6	8.3	50.1	337.50	17.5	7.5	42.7

POSITION 3				POSITION 4			
WIND AZIMUTH	U/UINF (PERCENT)	URMS/UINF (PERCENT)	URMS/U (PERCENT)	WIND AZIMUTH	U/UINF (PERCENT)	URMS/UINF (PERCENT)	URMS/U (PERCENT)
0.00	18.9	10.3	54.5	0.00	12.9	9.1	70.9
22.50	28.5	13.0	45.7	22.50	20.0	11.0	55.1
45.00	14.6	6.8	47.0	45.00	8.2	3.7	45.6
67.50	19.7	9.6	48.6	67.50	11.5	6.0	52.2
90.00	5.8	4.2	72.5	90.00	2.0	1.9	95.1
112.50	3.8	3.0	77.7	112.50	6.2	4.2	68.6
135.00	17.3	7.6	43.8	135.00	17.9	8.9	49.7
157.50	17.0	7.0	41.2	157.50	13.7	6.1	44.9
180.00	18.6	8.0	42.7	180.00	9.7	4.5	46.8
202.50	24.4	10.2	41.7	202.50	16.2	8.1	49.8
225.00	20.7	10.4	50.3	225.00	18.2	8.8	48.4
247.50	17.2	9.5	55.0	247.50	17.3	8.2	47.1
270.00	30.2	15.2	50.3	270.00	19.4	11.1	57.0
292.50	19.7	9.4	47.7	292.50	12.8	6.3	49.6
315.00	13.0	6.8	52.6	315.00	13.1	5.2	39.5
337.50	16.9	7.7	45.5	337.50	14.3	5.5	38.6

TABLE 2. PEDESTRIAN WIND VELOCITIES AND TURBULENCE INTENSITIES

COLUMBIA PLAZA DENVER, COLORADO

POSITION 13

WIND AZIMUTH	U/UINF (PERCENT)	URMS/UINF (PERCENT)	URMS/U (PERCENT)
0.00	39.1	8.5	21.7
22.50	45.7	10.3	22.6
45.00	62.7	15.9	25.3
67.50	21.2	12.1	56.9
90.00	9.7	6.0	61.3
112.50	17.1	6.2	36.4
135.00	42.1	9.7	23.0
157.50	37.9	9.9	26.3
180.00	43.8	8.5	19.4
202.50	33.7	9.8	29.1
225.00	13.1	6.5	49.1
247.50	11.0	5.2	47.3
270.00	11.5	6.1	52.6
292.50	7.4	3.5	47.5
315.00	16.0	7.1	44.4
337.50	33.7	8.5	25.3

POSITION 14

WIND AZIMUTH	U/UINF (PERCENT)	URMS/UINF (PERCENT)	URMS/U (PERCENT)
0.00	14.1	7.2	51.2
22.50	24.4	12.2	50.2
45.00	29.9	14.4	48.1
67.50	37.5	13.0	34.7
90.00	31.8	10.0	31.4
112.50	31.4	12.7	40.3
135.00	27.3	12.5	45.9
157.50	23.2	11.6	50.1
180.00	36.6	11.7	31.9
202.50	40.3	12.8	31.6
225.00	42.0	11.7	27.8
247.50	40.7	13.1	32.3
270.00	26.1	13.5	51.7
292.50	19.6	9.1	46.6
315.00	15.7	7.9	50.1
337.50	14.8	7.3	49.4

POSITION 15

WIND AZIMUTH	U/UINF (PERCENT)	URMS/UINF (PERCENT)	URMS/U (PERCENT)
0.00	23.6	10.8	45.8
22.50	35.0	17.8	50.9
45.00	21.4	10.2	47.7
67.50	33.6	15.3	45.7
90.00	32.1	11.0	34.2
112.50	41.1	12.6	30.7
135.00	41.5	12.7	30.6
157.50	52.2	14.7	28.1
180.00	23.1	10.9	47.2
202.50	17.3	9.8	56.6
225.00	16.6	8.8	53.1
247.50	23.6	12.6	53.6
270.00	41.6	16.9	40.7
292.50	35.3	15.1	42.8
315.00	33.6	9.2	27.5
337.50	30.5	7.8	25.5

POSITION 16

WIND AZIMUTH	U/UINF (PERCENT)	URMS/UINF (PERCENT)	URMS/U (PERCENT)
0.00	20.9	8.6	41.0
22.50	24.5	11.9	48.6
45.00	37.0	15.3	41.4
67.50	51.2	17.6	34.4
90.00	42.4	11.2	26.3
112.50	29.1	12.0	41.3
135.00	28.0	13.7	49.1
157.50	36.5	15.1	41.3
180.00	24.1	11.8	48.8
202.50	20.9	9.6	45.8
225.00	25.5	10.3	40.5
247.50	34.8	11.0	31.7
270.00	38.6	14.7	38.0
292.50	28.1	11.8	41.9
315.00	26.6	13.1	49.1
337.50	25.7	10.6	41.2

TABLE 2. PEDESTRIAN WIND VELOCITIES AND TURBULENCE INTENSITIES
COLUMBIA PLAZA DENVER, COLORADO

POSITION 9

WIND AZIMUTH	U/UINF (PERCENT)	URMS/UINF (PERCENT)	URMS/U (PERCENT)
0.00	17.0	11.5	67.5
22.50	23.2	14.2	61.0
45.00	9.1	4.1	45.3
67.50	6.5	3.1	47.1
90.00	2.2	2.5	112.0
112.50	2.5	2.4	92.9
135.00	33.3	20.2	60.6
157.50	43.4	18.0	41.4
180.00	36.3	11.5	31.7
202.50	37.2	12.6	33.9
225.00	34.1	10.4	30.6
247.50	29.1	9.5	32.8
270.00	23.8	15.3	64.2
292.50	14.2	7.0	49.2
315.00	22.7	10.4	45.7
337.50	21.6	9.0	41.8

POSITION 10

WIND AZIMUTH	U/UINF (PERCENT)	URMS/UINF (PERCENT)	URMS/U (PERCENT)
0.00	48.7	12.1	24.8
22.50	69.2	12.0	17.4
45.00	68.3	11.3	16.5
67.50	65.5	10.3	15.8
90.00	23.0	5.9	25.7
112.50	18.6	6.3	34.0
135.00	18.8	10.7	56.7
157.50	23.2	12.5	53.9
180.00	34.9	10.7	30.8
202.50	51.1	12.8	25.1
225.00	54.8	11.8	21.5
247.50	54.5	9.7	17.8
270.00	26.4	15.5	58.5
292.50	25.5	11.4	44.8
315.00	22.2	9.2	41.3
337.50	11.8	6.3	53.7

POSITION 11

WIND AZIMUTH	U/UINF (PERCENT)	URMS/UINF (PERCENT)	URMS/U (PERCENT)
0.00	25.6	11.8	46.0
22.50	35.7	11.7	32.8
45.00	55.7	9.3	16.7
67.50	32.0	6.2	19.2
90.00	23.8	5.4	22.5
112.50	14.7	6.2	42.3
135.00	18.7	9.0	48.3
157.50	10.7	5.1	47.5
180.00	15.1	7.4	48.7
202.50	14.8	8.8	59.8
225.00	20.8	11.6	56.0
247.50	19.0	9.6	50.3
270.00	13.6	7.2	52.7
292.50	14.9	7.8	52.8
315.00	41.1	12.1	29.4
337.50	17.4	9.9	57.0

POSITION 12

WIND AZIMUTH	U/UINF (PERCENT)	URMS/UINF (PERCENT)	URMS/U (PERCENT)
0.00	25.8	9.3	35.9
22.50	26.8	12.7	47.3
45.00	31.0	13.8	44.3
67.50	8.9	5.4	60.8
90.00	3.8	3.3	88.9
112.50	22.0	10.6	48.4
135.00	46.6	12.1	25.9
157.50	42.1	9.5	22.5
180.00	36.8	10.4	28.3
202.50	24.0	12.0	50.1
225.00	15.6	8.4	53.5
247.50	13.0	6.7	51.9
270.00	15.7	8.4	53.8
292.50	13.6	7.1	52.1
315.00	26.3	9.2	34.8
337.50	29.0	10.9	37.7

TABLE 2. PEDESTRIAN WIND VELOCITIES AND TURBULENCE INTENSITIES
COLUMBIA PLAZA DENVER, COLORADO

POSITION 5				POSITION 6			
WIND AZIMUTH	U/UINF (PERCENT)	URMS/UINF (PERCENT)	URMS/U (PERCENT)	WIND AZIMUTH	U/UINF (PERCENT)	URMS/UINF (PERCENT)	URMS/U (PERCENT)
0.00	9.2	4.8	52.6	0.00	13.7	7.7	55.8
22.50	19.2	8.9	46.4	22.50	17.3	8.6	49.8
45.00	7.7	3.2	42.4	45.00	14.7	5.9	40.3
67.50	7.8	3.4	43.8	67.50	10.7	5.1	47.5
90.00	1.2	1.0	83.4	90.00	2.7	2.8	104.2
112.50	4.1	2.8	67.4	112.50	4.4	3.1	69.2
135.00	16.9	9.3	54.7	135.00	19.4	9.8	50.5
157.50	12.4	5.6	45.0	157.50	22.0	8.7	39.4
180.00	8.7	3.9	45.5	180.00	20.0	6.2	30.9
202.50	16.0	7.3	45.4	202.50	25.2	10.2	40.4
225.00	14.0	6.5	46.6	225.00	21.9	9.1	41.5
247.50	12.2	5.6	45.6	247.50	19.4	8.3	43.1
270.00	14.4	7.7	53.7	270.00	24.4	11.1	45.5
292.50	10.3	4.2	41.1	292.50	19.1	9.3	49.0
315.00	12.0	5.8	48.2	315.00	21.5	12.0	55.7
337.50	12.5	5.2	41.6	337.50	20.8	11.4	54.7

POSITION 7				POSITION 8			
WIND AZIMUTH	U/UINF (PERCENT)	URMS/UINF (PERCENT)	URMS/U (PERCENT)	WIND AZIMUTH	U/UINF (PERCENT)	URMS/UINF (PERCENT)	URMS/U (PERCENT)
0.00	22.4	13.6	60.7	0.00	17.2	11.9	69.1
22.50	32.0	16.6	51.7	22.50	27.5	13.0	47.2
45.00	14.7	6.8	46.2	45.00	17.6	7.4	41.8
67.50	13.6	7.1	52.5	67.50	9.7	5.5	56.3
90.00	5.2	4.7	89.6	90.00	2.8	2.8	97.3
112.50	6.4	5.1	79.5	112.50	2.4	2.6	105.8
135.00	27.4	14.6	53.4	135.00	41.8	17.9	42.7
157.50	29.9	11.3	37.9	157.50	55.1	13.5	24.5
180.00	24.2	7.6	31.2	180.00	46.6	8.4	18.0
202.50	27.9	10.0	36.0	202.50	34.4	12.9	37.6
225.00	26.0	11.5	44.2	225.00	34.9	12.5	35.9
247.50	21.8	10.1	46.4	247.50	27.9	10.2	36.5
270.00	31.3	14.5	46.5	270.00	32.1	18.4	57.4
292.50	20.1	8.9	44.4	292.50	17.3	9.4	54.5
315.00	15.2	8.5	55.8	315.00	24.7	12.4	50.1
337.50	23.2	9.9	42.5	337.50	31.1	10.2	32.8

TABLE 3

ANNUAL PERCENTAGE FREQUENCIES OF WIND DIRECTION AND SPEED

Based on Summary of Hourly Observations
Stapleton Airfield, Denver
1951-1960

Anemometer Elevation = 72 ft above ground

Annual Hourly Observations of Wind Speed - Miles Per Hour

<u>Direction</u>	<u>0-3</u>	<u>4-7</u>	<u>8-12</u>	<u>13-18</u>	<u>19-24</u>	<u>25-31</u>	<u>32-38</u>	<u>39-46</u>	<u>Total</u>
N	1.1	1.9	2.0	1.1	0.3	0.2	0.1		6.7
NNE	0.7	1.4	1.1	0.9	0.2	0.1	0.1		4.5
NE	1.1	1.9	1.7	0.9	0.2	0.1			5.9
ENE	0.8	1.2	1.1	0.5	0.2	0.1			3.9
E	1.1	1.3	1.3	0.5	0.1				4.3
ESE	0.8	1.1	1.1	0.4	0.1				3.5
SE	1.1	2.1	2.0	0.7	0.1				6.0
SSE	1.1	2.1	2.1	1.0	0.4	0.2			6.9
S	2.1	5.1	7.1	3.7	0.6	0.2			18.8
SSW	1.1	3.4	3.9	1.7	0.1				10.2
SW	1.2	2.3	1.5	0.4	0.1				5.5
WSW	0.9	1.0	0.7	0.2	0.1	0.1			3.0
W	0.8	1.2	0.7	0.6	0.4	0.2	0.1	0.1	4.1
WNW	0.8	0.9	1.0	1.0	0.5	0.4	0.1		4.7
NW	1.3	1.8	1.5	1.2	0.5	0.2			6.5
NNW	0.9	1.7	1.7	0.9	0.2	0.1			5.5
Total	16.9	30.4	30.5	15.7	4.1	1.9	0.4	0.1	100.0

TABLE 4
SUMMARY OF WIND EFFECTS ON PEOPLE

	<u>Beaufort number</u>	<u>Speed (mph)</u>	<u>Effects</u>
Calm, light air	0,1	0- 3	Calm, no noticeable wind
Light breeze	2	4- 7	Wind felt on face
Gentle breeze	3	8-12	Wind extends light flag Hair is disturbed Clothing flaps
Moderate breeze	4	13-18	Raises dust, dry soil and loose paper Hair disarranged
Fresh breeze	5	19-24	Force of wind felt on body Drifting snow becomes airborne Limit of agreeable wind on land
Strong breeze	6	25-31	Umbrellas used with difficulty Hair blown straight Difficult to walk steadily Wind noise on ears unpleasant Windborne snow above head height (blizzard)
Near gale	7	32-38	Inconvenience felt when walking
Gale	8	39-46	Generally impedes progress Great difficulty with balance in gusts
Strong gale	9	47-54	People blown over by gusts

Note: Table from Reference 4, p. 40

TABLE 5

CALCULATION OF REFERENCE PRESSURE

Basic wind speed from ANSI A58.1 (Ref. 5):

50-yr. fastest mile at 30 ft = 80 mph.

Mean hourly wind speed, 30 ft = $\frac{80}{1.27} = 63.0$ mph.

Mean hourly gradient wind speed = $63.0 \left(\frac{1000}{30}\right)^{.17} = 114.4$ mph.

Mean hourly wind at reference location = U_{∞} = gradient wind = 114.4 mph

Reference pressure at 5000 ft = $0.83 (0.00256)(114.4)^2 = 27.8$ psf

Use reference pressure = 28 psf

Reduction of cladding peak pressures to 1 minute equivalent load for glass: multiply by glass load factor = 0.73 (Ref. 8)

Loads for 100-yr. recurrence wind:

100-yr. fastest mile at 30 ft = 90 mph

Multiply 50-yr. loads by $\left(\frac{90}{80}\right)^2 = 1.27$

TABLE 6 --

CLADDING AND GLASS LOADS-- CONFIGURATION A -- COLUMBIA PLAZA -- DENVER, COLORADO
 LARGEST VALUE OF ABS(CPMAX) OR ABS(CPMIN), PEAK LOAD AND GLASS LOAD (1 MINUTE EQUIVALENT)
 REFERENCE PRESSURE = 28. PSF GLASS LOAD FACTOR = .730

TAP	AZI-MUTH	PRESS COEFF	PEAK LOAD	GLASS LOAD (PSF)	TAP	AZI-MUTH	PRESS COEFF	PEAK LOAD	GLASS LOAD (PSF)	TAP	AZI-MUTH	PRESS COEFF	PEAK LOAD	GLASS LOAD (PSF)
1	45	.60	16.9	12.4	51	60	.49	13.8	10.1	142	225	1.39	39.0	28.4
2	30	.74	20.6	15.1	52	135	.86	22.4	17.7	143	150	.84	23.3	17.1
3	30	.64	17.9	13.0	53	30	.91	22.5	18.0	144	150	1.01	23.8	20.6
4	30	.84	23.6	17.7	54	135	.88	22.4	17.9	145	300	.83	23.3	16.9
5	270	.57	16.0	11.7	55	135	.55	18.4	13.5	146	165	1.11	21.2	22.8
6	30	.71	19.8	14.4	56	45	.68	19.1	14.0	147	315	1.22	24.2	24.9
7	135	.69	19.3	14.1	57	270	.90	22.2	18.4	148	300	1.11	23.5	25.5
8	30	.65	18.3	13.3	58	270	.79	22.2	18.1	149	300	1.11	23.2	24.0
9	135	.79	22.2	16.6	59	135	.85	22.3	17.4	150	150	1.11	23.5	27.7
10	210	.74	20.7	15.1	101	165	1.80	50.0	36.7	151	900	1.11	30.7	44.6
11	270	.94	26.4	19.9	102	165	1.90	50.0	36.9	152	75	1.11	30.0	26.6
12	135	.93	26.1	19.5	103	225	1.11	44.8	33.0	153	75	1.11	30.0	26.6
13	135	.71	19.9	14.5	104	225	1.11	44.8	33.0	154	75	1.11	30.0	26.6
14	270	.90	22.3	18.2	105	240	1.11	44.8	33.0	155	3300	1.11	33.3	27.1
15	30	.79	22.2	16.6	106	195	1.21	57.0	42.2	156	105	1.11	33.8	20.0
16	30	.82	22.9	16.7	107	135	2.22	66.9	50.0	157	75	1.11	33.8	28.6
17	70	.63	17.7	12.8	108	0	1.11	44.8	33.0	158	75	1.11	33.8	28.6
18	70	.74	20.6	15.1	109	0	1.11	44.8	33.0	159	15	1.11	33.8	28.6
19	75	.73	20.5	15.0	110	0	1.11	44.8	33.0	160	3300	1.11	33.8	28.6
20	45	.90	25.1	18.8	111	15	1.11	44.8	33.0	161	345	1.11	33.8	28.6
21	30	.69	19.4	14.2	112	180	1.11	50.0	36.6	162	15	1.11	33.8	28.6
22	105	.55	14.3	10.9	113	0	2.22	66.6	50.0	163	105	1.11	33.8	28.6
23	45	.53	14.1	10.6	114	180	2.22	66.6	50.0	164	120	1.11	33.8	28.6
24	30	.74	20.6	15.1	115	0	2.22	66.6	50.0	165	135	2.22	33.8	28.6
25	105	.45	12.5	9.9	116	0	1.11	44.8	33.0	166	135	2.22	33.8	28.6
26	105	.39	10.8	7.9	117	0	1.11	44.8	33.0	167	15	1.11	33.8	28.6
27	45	.44	12.4	9.9	118	180	1.11	44.8	33.0	168	15	1.11	33.8	28.6
28	135	.67	18.8	13.7	119	180	1.11	44.8	33.0	169	3300	1.11	33.8	28.6
29	60	.99	27.7	20.2	120	15	1.11	44.8	33.0	170	3300	1.11	33.8	28.6
30	60	.58	16.2	11.8	121	0	1.11	44.8	33.0	171	105	1.11	33.8	28.6
31	105	.65	18.2	13.3	122	150	1.11	44.8	33.0	172	105	1.11	33.8	28.6
32	40	.87	24.3	18.8	123	180	1.11	44.8	33.0	173	120	1.11	33.8	28.6
33	60	1.41	39.5	28.8	124	180	1.11	44.8	33.0	174	105	1.11	33.8	28.6
34	15	1.07	30.0	22.9	125	240	1.11	44.8	33.0	175	345	1.11	33.8	28.6
35	30	.64	17.7	13.1	126	150	1.11	44.8	33.0	176	345	1.11	33.8	28.6
36	15	.55	15.3	11.1	127	150	1.11	44.8	33.0	177	345	1.11	33.8	28.6
37	75	.62	17.3	12.2	128	150	1.11	44.8	33.0	178	345	1.11	33.8	28.6
38	75	.82	23.0	16.8	129	165	1.11	44.8	33.0	179	105	1.11	33.8	28.6
39	150	.63	17.6	12.6	130	210	1.11	44.8	33.0	180	105	1.11	33.8	28.6
40	150	.51	14.3	10.4	131	15	1.11	44.8	33.0	181	120	1.11	33.8	28.6
41	210	.74	20.7	15.1	132	210	1.11	44.8	33.0	182	120	1.11	33.8	28.6
42	210	.54	15.3	11.1	133	150	1.11	44.8	33.0	183	3300	1.11	33.8	28.6
43	210	.20	33.7	24.6	134	135	1.11	44.8	33.0	184	3300	1.11	33.8	28.6
44	40	.88	30.0	22.4	135	165	1.11	44.8	33.0	185	105	1.11	33.8	28.6
45	150	.67	18.8	13.7	136	165	1.11	44.8	33.0	186	105	2.22	33.8	28.6
46	150	.15	32.2	23.3	137	165	1.11	44.8	33.0	187	3300	1.11	33.8	28.6
47	150	.77	21.4	15.5	138	15	1.11	44.8	33.0	188	3300	1.11	33.8	28.6
48	225	.05	29.5	21.1	139	210	1.11	44.8	33.0	189	3300	1.11	33.8	28.6
49	75	.71	19.9	14.5	140	15	1.11	44.8	33.0	190	300	1.11	33.8	28.6
50	70	.69	19.3	14.1	141	165	1.11	44.8	33.0	191	900	1.11	33.8	28.6

TABLE 6 --

CLADDING AND GLASS LOADS-- CONFIGURATION A -- COLUMBIA PLAZA -- DENVER, COLORADO
 (LARGEST VALUE OF ABS(CPMAX) OR ABS(CPMIN)), PEAK LOAD AND GLASS LOAD (1 MINUTE EQUIVALENT)
 REFERENCE PRESSURE = 28.7 PSF GLASS LOAD FACTOR = 730

TAP	AZI-MUTH	PRESS COEFF	PEAK LOAD	GLASS LOAD	TAP	AZI-MUTH	PRESS COEFF	PEAK LOAD	GLASS LOAD	TAP	AZI-MUTH	PRESS COEFF	PEAK LOAD	GLASS LOAD
			(PSF)					(PSF)					(PSF)	
426	60	1.19	33.2	24.2	432	210	1.31	36.6	26.7	437	210	1.20	33.6	24.5
427	210	1.15	32.2	23.5	433	210	.97	27.0	19.7	438	210	1.22	34.1	24.9
428	210	1.39	38.9	28.4	434	30	1.04	29.2	21.3	439	210	1.16	32.3	23.6
429	60	1.93	54.0	39.4	435	210	.95	26.7	19.5	440	210	1.04	29.2	21.3
430	210	1.00	28.1	20.5	436	30	.97	27.1	19.8	441	210	1.22	34.1	24.9
431	210	1.06	29.6	21.6										

APPENDIX A
PRESSURE DATA

Note: Pressure coefficients are defined in Section 4.3.
Pressure tap designation is explained in Figure 3.

APPENDIX A -- PRESSURE DATA:

C O L U M B I A P L A Z A , D E N V E R

WD	TAP	CPNEAN	CPRMS	CPMAX	CPMIN	WD	TAP	CPNEAN	CPRMS	CPMAX	CPMIN	WD	TAP	CPNEAN	CPRMS	CPMAX	CPMIN
0	1	-.198	.033	-.039	-.313	0	51	-.050	.056	-.195	-.265	0	142	-.316	.099	.033	-.813
0	2	-.197	.040	-.164	-.336	0	52	-.192	.038	-.047	-.378	0	143	-.205	.054	.000	-.397
0	3	-.176	.046	.075	-.335	0	53	-.187	.039	-.018	-.365	0	144	-.186	.062	.064	-.417
0	4	-.161	.054	.105	-.324	0	54	-.178	.036	.000	-.327	0	145	-.182	.054	.048	-.384
0	5	-.191	.035	-.025	-.293	0	55	-.175	.037	.025	-.337	0	146	-.251	.046	-.052	-.408
0	6	-.174	.053	.177	-.399	0	56	-.179	.042	.027	-.356	0	147	-.505	.118	-.246	-.996
0	7	-.178	.037	.043	-.290	0	57	-.193	.036	-.023	-.397	0	148	-.467	.123	-.118	-1.148
0	8	-.170	.045	.072	-.322	0	58	-.183	.035	.004	-.338	0	149	-.440	.112	-.149	-.929
0	9	-.178	.039	.007	-.333	0	59	-.172	.039	.066	-.335	0	150	-.511	.114	-.225	-1.020
0	10	-.175	.045	.052	-.359	0	101	-.454	.126	-.022	-.958	0	151	-.381	.094	-.145	-.758
0	11	-.168	.045	.063	-.394	0	102	-.605	.182	-.092	-1.347	0	152	-.389	.095	-.109	-.774
0	12	-.159	.047	.011	-.440	0	103	-.771	.149	-.260	-1.295	0	153	-.390	.100	-.113	-.936
0	13	-.183	.041	.018	-.342	0	104	-.880	.158	-.414	-1.596	0	154	-.468	.107	-.147	-.996
0	14	-.176	.034	-.049	-.305	0	105	-.364	.112	-.053	-.773	0	155	-.467	.073	-.280	-.674
0	15	-.179	.043	.054	-.374	0	106	-.348	.119	.104	-.813	0	156	-.437	.109	-.168	-.855
0	16	-.172	.039	-.020	-.340	0	107	-.359	.157	.186	-1.025	0	157	-.406	.092	-.151	-.771
0	17	-.186	.045	.005	-.363	0	108	-1.009	.199	-.478	-1.951	0	158	-.485	.103	-.190	-.875
0	18	-.181	.042	-.020	-.397	0	109	-.869	.191	-.305	-1.507	0	159	-.469	.106	-.241	-1.087
0	19	-.151	.028	-.059	-.288	0	110	-.780	.234	-.304	-1.608	0	160	-.472	.096	-.239	-.952
0	20	-.169	.050	-.045	-.494	0	111	-.490	.171	-.155	-1.321	0	161	-.485	.088	-.233	-.939
0	21	-.165	.091	.054	-.569	0	112	-.420	.111	-.173	-1.049	0	162	-.569	.094	-.296	-.951
0	22	-.152	.024	-.063	-.264	0	113	-1.064	.219	-.463	-2.252	0	163	-.448	.081	-.208	-.788
0	23	-.163	.033	-.036	-.351	0	114	-.508	.123	-.183	-1.447	0	164	-.413	.084	-.159	-.715
0	24	-.157	.100	.063	-.496	0	115	-1.141	.279	-.397	-2.244	0	165	-.361	.080	-.089	-.674
0	25	-.142	.024	-.061	-.229	0	116	-.815	.343	-.142	-1.889	0	166	-.413	.087	-.121	-.847
0	26	-.149	.025	-.067	-.244	0	117	-.533	.255	-.149	-1.515	0	167	-.559	.124	-.194	-1.180
0	27	-.129	.031	-.032	-.240	0	118	-.481	.153	-.187	-1.423	0	168	-.572	.138	-.166	-1.184
0	28	-.086	.057	.199	-.286	0	119	-.394	.082	-.155	-.927	0	169	-.527	.151	-.058	-1.282
0	29	-.133	.102	.313	-.547	0	120	-.455	.285	.211	-1.562	0	170	-.541	.151	-.164	-1.044
0	30	.072	.085	.493	-.161	0	121	-.292	.142	-.010	-1.431	0	171	-.307	.107	-.060	-.741
0	31	.087	.089	.566	-.204	0	122	-.317	.084	-.100	-1.025	0	172	-.260	.089	.007	-.656
0	32	.104	.087	.510	-.199	0	123	-.255	.063	-.045	-.650	0	173	-.245	.075	.014	-.559
0	33	-.093	.106	.159	-.621	0	124	-.361	.076	-.140	-.677	0	174	-.321	.070	-.100	-.614
0	34	-.105	.087	.231	-.475	0	125	-.434	.169	.130	-1.164	0	175	-.350	.119	-.103	-.977
0	35	-.060	.067	.335	-.127	0	126	-.455	.150	-.107	-1.233	0	176	-.325	.113	-.078	-.973
0	36	.079	.065	.490	-.110	0	127	-.299	.096	-.043	-.760	0	177	-.292	.110	-.007	-1.208
0	37	-.058	.053	.195	-.279	0	128	-.267	.074	-.026	-.573	0	178	-.254	.093	.009	-.845
0	38	.031	.059	.269	-.125	0	129	-.290	.070	-.091	-.658	0	179	-.237	.081	.002	-.766
0	39	.088	.061	.428	-.050	0	130	-.353	.075	-.109	-.721	0	180	-.199	.060	.007	-.662
0	40	.084	.063	.356	-.076	0	131	-.215	.041	-.076	-.416	0	181	-.195	.054	.000	-.684
0	41	-.015	.045	.245	-.136	0	132	-.268	.068	-.076	-.637	0	182	-.199	.047	-.030	-.613
0	42	-.030	.049	.352	-.157	0	133	-.255	.060	-.012	-.586	0	183	-.251	.059	-.119	-.730
0	43	.010	.084	.534	-.308	0	134	-.305	.056	-.102	-.529	0	184	-.221	.044	-.091	-.507
0	44	-.039	.101	.279	-.461	0	135	-.214	.042	-.017	-.394	0	185	-.174	.038	-.009	-.375
0	45	-.036	.091	.286	-.401	0	136	-.213	.042	-.083	-.369	0	186	-.166	.045	.007	-.426
0	46	-.031	.071	.255	-.249	0	137	-.209	.045	-.067	-.437	0	187	-.239	.049	-.078	-.595
0	47	-.192	.073	.181	-.450	0	138	-.276	.042	-.102	-.470	0	188	-.221	.046	-.070	-.523
0	48	-.164	.076	.065	-.617	0	139	-.229	.072	.007	-.714	0	189	-.224	.047	-.002	-.468
0	49	-.186	.049	-.029	-.429	0	140	-.179	.050	.019	-.386	0	190	-.204	.041	-.061	-.424
0	50	-.085	.048	.112	-.296	0	141	-.164	.040	-.019	-.322	0	191	-.186	.037	-.019	-.321

APPENDIX A -- PRESSURE DATA:

C O L U M B I A P L A Z A , D E N V E R

WD	TAP	CPMEAN	CPRMS	CPMAX	CPMIN	WD	TAP	CPMEAN	CPRMS	CPMAX	CPMIN	WD	TAP	CPMEAN	CPRMS	CPMAX	CPMIN
0	192	-.162	.035	-.021	-.265	0	308	-.369	.128	.085	-1.004	0	368	.085	.103	.447	-.301
0	193	-.166	.038	-.016	-.302	0	309	-.413	.145	.112	-1.047	0	369	.202	.122	.689	-.271
0	194	-.159	.043	.002	-.372	0	310	-.460	.158	-.035	-1.421	0	370	.264	.137	.833	-.230
0	195	-.221	.047	-.089	-.534	0	311	-.476	.141	-.129	-1.389	0	371	.295	.154	.884	-.301
0	196	-.228	.039	-.117	-.423	0	312	-.473	.122	-.183	-1.093	0	372	.257	.148	.799	-.299
0	197	-.217	.048	-.073	-.479	0	313	-.377	.136	.021	-1.054	0	373	.172	.127	.622	-.368
0	198	-.204	.039	-.047	-.438	0	314	-.465	.133	-.185	-1.297	0	374	.012	.091	.335	-.528
0	199	-.170	.035	-.016	-.335	0	315	-.373	.176	.127	-1.386	0	375	-.191	.065	.059	-.416
0	200	-.179	.041	.010	-.333	0	316	-.418	.145	.052	-.994	0	376	.069	.087	.404	-.252
0	201	-.204	.048	-.049	-.476	0	317	-.474	.152	-.024	-1.138	0	377	.158	.110	.516	-.258
0	202	-.169	.042	.028	-.328	0	318	-.457	.158	-.094	-1.201	0	378	.220	.120	.636	-.212
0	203	-.346	.103	.178	-.828	0	319	-.416	.152	-.075	-1.128	0	379	.229	.132	.824	-.210
0	204	-.339	.104	.002	-.847	0	320	-.278	.122	.042	-.788	0	380	.131	.118	.591	-.320
0	205	-.317	.096	.000	-.765	0	321	-.340	.139	.083	-.981	0	381	.029	.091	.382	-.442
0	206	-.319	.101	.073	-.735	0	322	-.444	.159	.056	-1.145	0	382	-.157	.088	.117	-.527
0	207	-.328	.112	.047	-.831	0	323	-.560	.180	-.143	-1.668	0	383	-.147	.049	.085	-.347
0	208	-.376	.096	-.088	-.728	0	324	-.593	.192	-.174	-1.418	0	384	.041	.070	.329	-.200
0	209	-.334	.113	.047	-.873	0	325	-.208	.057	-.031	-.482	0	385	.036	.068	.389	-.160
0	210	-.332	.078	-.080	-.770	0	326	-.233	.072	-.052	-.636	0	386	-.117	.077	.193	-.434
0	211	-.301	.069	-.044	-.594	0	327	-.303	.108	-.049	-.884	0	387	-.133	.052	.042	-.401
0	212	-.314	.071	-.059	-.568	0	328	-.475	.144	-.106	-1.039	0	388	.052	.073	.353	-.181
0	213	-.273	.074	-.028	-.568	0	329	-.613	.156	-.218	-1.316	0	389	.126	.093	.487	-.143
0	214	-.326	.135	-.002	-1.114	0	330	-.237	.062	-.026	-.624	0	390	.174	.101	.596	-.107
0	215	-.246	.070	-.042	-.576	0	331	-.429	.128	-.073	-1.196	0	391	.178	.102	.663	-.149
0	216	-.249	.069	-.031	-.504	0	332	-.242	.068	-.054	-.590	0	392	.130	.089	.565	-.105
0	217	-.223	.064	-.028	-.518	0	333	-.160	.049	.026	-.468	0	393	.049	.078	.432	-.136
0	218	-.196	.063	-.007	-.499	0	334	-.179	.088	.049	-.718	0	394	-.110	.080	.138	-.484
0	219	-.207	.092	.042	-.978	0	335	-.312	.143	.078	-.996	0	403	.202	.119	.622	-.162
0	220	-.230	.054	-.052	-.504	0	336	-.454	.145	-.052	-1.220	0	404	.167	.114	.567	-.210
0	221	-.200	.048	-.061	-.547	0	347	-.265	.060	-.047	-.604	0	405	.115	.118	.503	-.258
0	222	-.187	.039	-.056	-.361	0	348	-.121	.059	.150	-.381	0	406	.095	.121	.504	-.277
0	223	-.167	.039	.007	-.344	0	349	-.100	.068	.207	-.335	0	407	-.824	.230	-.093	-1.521
0	224	-.186	.053	.055	-.409	0	350	-.074	.072	.197	-.317	0	408	.344	.143	.803	-.076
0	225	-.158	.039	.007	-.307	0	351	-.054	.076	.230	-.296	0	409	-.976	.272	-.186	-1.920
0	226	-.158	.037	-.012	-.304	0	352	-.044	.081	.277	-.320	0	410	.369	.153	.986	-.088
0	227	-.159	.037	-.021	-.292	0	353	-.007	.088	.321	-.278	0	411	.377	.139	.906	.031
0	228	-.215	.047	-.083	-.535	0	354	.020	.150	.450	-.772	0	412	.354	.142	.774	-.033
0	229	-.158	.038	.000	-.286	0	355	-.220	.068	-.019	-.576	0	413	.257	.145	.789	-.191
0	230	-.157	.038	.002	-.293	0	356	-.019	.074	.242	-.273	0	414	-1.050	.329	.103	-2.521
0	231	-.155	.038	.000	-.295	0	357	.164	.106	.506	-.154	0	415	-.154	.160	.174	-.915
0	232	-.189	.040	-.010	-.352	0	358	.153	.174	.636	-.516	0	416	-.084	.058	.144	-.375
0	233	-.183	.043	-.035	-.385	0	359	-.204	.097	.045	-.611	0	417	-.152	.070	.141	-.413
0	234	-.201	.050	-.026	-.428	0	360	.074	.093	.343	-.200	0	418	-.202	.124	.251	-.599
0	301	-.822	.152	-.340	-1.373	0	361	.193	.101	.513	-.161	0	419	-.433	.378	.410	-1.790
0	302	-.582	.186	-.099	-1.290	0	362	.267	.113	.622	-.120	0	420	-.301	.160	.102	-.925
0	303	-.469	.137	-.054	-.968	0	363	.361	.128	.743	-.014	0	421	-.162	.107	.098	-.742
0	304	-.424	.149	.049	-1.018	0	364	.386	.137	.795	-.045	0	422	-.162	.076	.062	-.518
0	305	-.567	.138	-.233	-1.510	0	365	.334	.148	.881	-.228	0	423	-.242	.075	-.038	-.591
0	306	-.759	.149	-.338	-1.295	0	366	.285	.207	.880	-.558	0	424	-.570	.236	.257	-1.440
0	307	-.808	.151	-.320	-1.417	0	367	-.204	.087	.089	-.526	0	425	-.215	.134	.091	-.868

APPENDIX A -- PRESSURE DATA:

C O L U M B I A P L A Z A , D E N V E R

WD	TAP	CPMEAN	CPRMS	CPMAX	CPMIN	WD	TAP	CPMEAN	CPRMS	CPMAX	CPMIN	WD	TAP	CPMEAN	CPRMS	CPMAX	CPMIN
0	426	-.124	.083	.153	-.513	15	35	.114	.063	.385	-.078	15	126	-.571	.139	-.228	-1.433
0	427	-.096	.061	.122	-.338	15	36	.126	.086	.548	-.088	15	127	-.480	.133	-.176	-1.216
0	428	-.338	.084	-.083	-.741	15	37	-.138	.039	.002	-.336	15	128	-.424	.129	-.002	-.945
0	429	-.198	.129	.122	-.987	15	38	.081	.060	.326	-.149	15	129	-.398	.154	-.034	-1.086
0	430	-.111	.070	.129	-.563	15	39	.150	.080	.540	-.063	15	130	-.431	.086	-.219	-.881
0	431	-.093	.058	.122	-.434	15	40	.135	.084	.509	-.050	15	131	-.367	.132	-.066	-1.278
0	432	-.096	.054	.125	-.333	15	41	-.047	.046	.179	-.181	15	132	-.348	.078	-.174	-.786
0	433	-.142	.050	.031	-.334	15	42	-.085	.039	.104	-.216	15	133	-.360	.080	-.155	-.826
0	434	-.355	.088	-.084	-.859	15	43	.072	.099	.427	-.287	15	134	-.447	.101	-.200	-1.298
0	435	-.076	.065	.300	-.293	15	44	.036	.117	.429	-.615	15	135	-.360	.096	-.137	-.833
0	436	-.283	.095	.102	-.951	15	45	.071	.092	.393	-.249	15	136	-.383	.139	.070	-1.074
0	437	-.085	.066	.367	-.281	15	46	-.024	.067	.370	-.192	15	137	-.357	.096	-.105	-.912
0	438	-.069	.060	.337	-.203	15	47	-.259	.077	.126	-.634	15	138	-.452	.145	-.068	-1.401
0	439	-.081	.061	.360	-.210	15	48	-.170	.088	.082	-.552	15	139	-.336	.076	-.130	-.751
0	440	-.111	.065	.331	-.267	15	49	-.195	.047	-.028	-.443	15	140	-.340	.092	-.039	-.990
0	441	-.286	.098	.308	-.878	15	50	-.051	.057	.246	-.238	15	141	-.325	.134	.023	-1.026
15	1	-.193	.061	.151	-.347	15	51	-.058	.076	.246	-.335	15	142	-.409	.090	-.169	-.933
15	2	-.215	.060	.045	-.560	15	52	-.189	.051	-.019	-.606	15	143	-.339	.083	-.121	-.835
15	3	-.195	.072	.137	-.449	15	53	-.195	.050	-.009	-.428	15	144	-.336	.097	-.084	-1.006
15	4	-.161	.099	.272	-.563	15	54	-.187	.054	.039	-.486	15	145	-.326	.096	-.057	-.778
15	5	-.190	.053	.153	-.336	15	55	-.177	.057	.037	-.416	15	146	-.394	.125	-.104	-1.000
15	6	-.186	.083	.231	-.517	15	56	-.185	.063	.121	-.537	15	147	-.546	.094	-.272	-.879
15	7	-.174	.053	.216	-.333	15	57	-.198	.052	.114	-.386	15	148	-.512	.128	-.079	-1.138
15	8	-.187	.065	.252	-.419	15	58	-.186	.050	.017	-.346	15	149	-.492	.125	-.141	-1.140
15	9	-.177	.053	.055	-.325	15	59	-.176	.049	.050	-.324	15	150	-.547	.130	-.205	-1.354
15	10	-.182	.056	.123	-.370	15	101	-.610	.165	-.139	-1.407	15	151	-.406	.103	-.112	-.970
15	11	-.161	.064	.146	-.335	15	102	-.735	.166	-.034	-1.374	15	152	-.413	.109	-.091	-1.287
15	12	-.143	.070	.123	-.414	15	103	-.698	.137	-.320	-1.305	15	153	-.393	.104	-.046	-1.020
15	13	-.164	.072	.186	-.362	15	104	-.739	.166	-.288	-1.348	15	154	-.476	.115	-.149	-1.214
15	14	-.132	.062	.082	-.428	15	105	-.541	.124	-.130	-.990	15	155	-.530	.057	-.363	-.707
15	15	-.136	.081	.176	-.466	15	106	-.507	.160	.009	-1.266	15	156	-.487	.109	-.025	-.956
15	16	-.151	.065	.078	-.442	15	107	-.435	.152	.087	-1.175	15	157	-.375	.085	-.080	-.814
15	17	-.149	.076	.199	-.397	15	108	-.579	.102	-.281	-1.076	15	158	-.464	.099	-.149	-.872
15	18	-.164	.057	.104	-.478	15	109	-.596	.115	-.281	-1.254	15	159	-.556	.135	-.169	-1.194
15	19	-.153	.029	-.046	-.303	15	110	-.704	.157	-.311	-1.525	15	160	-.515	.110	-.156	-.886
15	20	-.193	.054	-.065	-.496	15	111	-.607	.161	-.073	-1.531	15	161	-.508	.096	-.166	-.933
15	21	-.161	.102	.057	-.587	15	112	-.600	.165	.023	-1.197	15	162	-.564	.096	-.264	-1.221
15	22	-.160	.028	-.058	-.285	15	113	-.553	.098	-.297	-1.058	15	163	-.429	.074	-.203	-.733
15	23	-.178	.039	-.041	-.355	15	114	-.716	.190	-.077	-1.692	15	164	-.404	.072	-.177	-.653
15	24	-.159	.113	.170	-.539	15	115	-.573	.105	-.274	-1.152	15	165	-.378	.056	-.160	-.547
15	25	-.143	.027	-.063	-.264	15	116	-.593	.109	-.295	-1.203	15	166	-.448	.073	-.221	-.707
15	26	-.159	.029	-.071	-.274	15	117	-.618	.136	-.255	-1.514	15	167	-.579	.163	-.096	-1.515
15	27	-.138	.035	.396	-.268	15	118	-.724	.159	-.194	-1.651	15	168	-.542	.147	-.073	-1.299
15	28	-.069	.074	.276	-.352	15	119	-.657	.183	-.128	-1.488	15	169	-.515	.138	-.107	-1.099
15	29	-.127	.147	.517	-.616	15	120	-.657	.169	-.286	-1.790	15	170	-.561	.121	-.146	-1.194
15	30	.105	.081	.486	-.138	15	121	-.653	.179	-.155	-1.430	15	171	-.400	.091	-.078	-.851
15	31	.151	.105	.608	-.070	15	122	-.719	.205	-.160	-1.631	15	172	-.363	.083	-.086	-.630
15	32	.184	.106	.621	-.071	15	123	-.580	.192	-.059	-1.358	15	173	-.328	.078	-.071	-.702
15	33	-.321	.187	.098	-1.194	15	124	-.568	.185	-.111	-1.274	15	174	-.381	.080	-.104	-.802
15	34	-.366	.144	-.067	-1.072	15	125	-.473	.136	-.173	-1.355	15	175	-.380	.114	.000	-.831

APPENDIX A -- PRESSURE DATA:

C O L U M B I A P L A Z A , D E N V E R

WD	TAP	CPMEAN	CPRMS	CPMAX	CPMIN	WD	TAP	CPMEAN	CPRMS	CPMAX	CPMIN	WD	TAP	CPMEAN	CPRMS	CPMAX	CPMIN
15	176	-.341	.100	-.005	-.798	15	226	-.162	.044	.028	-.313	15	352	.076	.110	.416	-.264
15	177	-.322	.099	-.028	-.715	15	227	-.162	.048	.064	-.343	15	353	.111	.110	.400	-.242
15	178	-.294	.086	-.009	-.697	15	228	-.252	.063	-.055	-.595	15	354	.210	.129	.568	-.311
15	179	-.238	.074	-.038	-.612	15	229	-.166	.044	.031	-.354	15	355	-.299	.083	.147	-.569
15	180	-.253	.065	-.043	-.593	15	230	-.159	.042	.012	-.291	15	356	.048	.090	.374	-.325
15	181	-.241	.060	-.019	-.521	15	231	-.154	.044	.028	-.314	15	357	.325	.131	.687	-.080
15	182	-.228	.049	-.021	-.463	15	232	-.203	.052	.051	-.434	15	358	.393	.145	.809	-.250
15	183	-.305	.070	-.055	-.578	15	233	-.218	.056	-.031	-.584	15	359	-.294	.103	.145	-.578
15	184	-.267	.061	-.078	-.636	15	234	-.237	.065	.031	-.644	15	360	.131	.100	.519	-.150
15	185	-.174	.049	.121	-.332	15	301	-.683	.132	-.332	-1.286	15	361	.265	.112	.684	-.066
15	186	-.169	.058	.021	-.395	15	302	-.653	.149	.042	-1.315	15	362	.351	.122	.800	-.007
15	187	-.232	.071	-.082	-.708	15	303	-.634	.170	-.075	-1.398	15	363	.463	.130	.923	.110
15	188	-.259	.058	-.078	-.536	15	304	-.579	.201	-.021	-1.453	15	364	.493	.137	.979	.126
15	189	-.248	.054	-.047	-.497	15	305	-.613	.157	-.212	-1.446	15	365	.524	.142	1.035	.099
15	190	-.219	.047	-.045	-.418	15	306	-.634	.130	-.297	-1.123	15	366	.496	.137	.974	.079
15	191	-.197	.045	-.007	-.371	15	307	-.658	.146	-.322	-1.525	15	367	-.242	.099	.989	-.611
15	192	-.170	.045	.059	-.327	15	308	-.351	.094	-.035	-.883	15	368	.098	.085	.399	-.152
15	193	-.178	.047	.036	-.381	15	309	-.408	.108	.040	-.903	15	369	.218	.096	.628	-.047
15	194	-.171	.055	.005	-.477	15	310	-.492	.129	-.107	-1.102	15	370	.306	.108	.714	.019
15	195	-.281	.069	-.088	-.604	15	311	-.619	.148	-.191	-1.089	15	371	.416	.133	.832	.023
15	196	-.263	.052	-.084	-.491	15	312	-.931	.259	-.315	-1.932	15	372	.413	.138	.839	.007
15	197	-.227	.055	-.007	-.562	15	313	-.341	.085	-.033	-.752	15	373	.322	.121	.701	-.111
15	198	-.206	.050	.012	-.424	15	314	-.922	.222	-.327	-1.756	15	374	.017	.077	.290	-.301
15	199	-.167	.051	.050	-.324	15	315	-.325	.111	.002	-.804	15	375	-.215	.072	.107	-.543
15	200	-.180	.053	.089	-.347	15	316	-.389	.147	.021	-1.002	15	376	.066	.067	.320	-.187
15	201	-.230	.061	.005	-.574	15	317	-.554	.211	.005	-1.387	15	377	.159	.085	.457	-.100
15	202	-.180	.058	.121	-.377	15	318	-.730	.221	-.067	-1.642	15	378	.249	.102	.608	-.029
15	203	-.332	.091	-.036	-.626	15	319	-.732	.205	-.121	-1.455	15	379	.322	.132	.791	-.064
15	204	-.338	.089	-.058	-.756	15	320	-.291	.110	.019	-1.051	15	380	.292	.125	.748	-.036
15	205	-.308	.090	-.012	-.662	15	321	-.362	.156	.016	-1.133	15	381	.148	.101	.574	-.244
15	206	-.293	.088	.005	-.706	15	322	-.488	.210	.021	-1.315	15	382	-.304	.080	.017	-.737
15	207	-.287	.082	-.019	-.697	15	323	-.663	.233	-.070	-1.469	15	383	-.160	.054	.017	-.388
15	208	-.354	.077	-.077	-.689	15	324	-.717	.206	-.089	-1.460	15	384	.066	.067	.313	-.105
15	209	-.288	.077	-.040	-.700	15	325	-.241	.078	-.021	-.715	15	385	.112	.085	.480	-.222
15	210	-.337	.055	-.147	-.571	15	326	-.286	.108	.026	-.823	15	386	-.281	.087	.019	-.604
15	211	-.294	.046	-.144	-.515	15	327	-.388	.150	-.030	-1.054	15	387	-.154	.053	.017	-.384
15	212	-.294	.049	-.133	-.511	15	328	-.563	.174	-.091	-1.584	15	388	.079	.063	.430	-.084
15	213	-.266	.057	-.083	-.555	15	329	-.614	.168	-.221	-1.385	15	389	.185	.085	.645	-.029
15	214	-.294	.093	.000	-.959	15	330	-.270	.094	-.035	-.956	15	390	.260	.100	.711	.017
15	215	-.274	.052	-.085	-.510	15	331	-.460	.138	-.163	-1.254	15	391	.310	.116	.822	.017
15	216	-.273	.051	-.118	-.595	15	332	-.260	.097	-.042	-.855	15	392	.288	.121	.881	.029
15	217	-.243	.044	-.107	-.498	15	333	-.207	.079	.075	-.611	15	393	.138	.101	.645	-.120
15	218	-.231	.053	-.064	-.585	15	334	-.275	.124	.135	-.858	15	394	-.311	.097	-.055	-.797
15	219	-.240	.082	-.017	-.733	15	335	-.431	.142	-.030	-1.268	15	403	.177	.141	.596	-.291
15	220	-.263	.055	-.104	-.646	15	336	-.485	.145	-.133	-1.205	15	404	.101	.121	.504	-.277
15	221	-.226	.040	-.112	-.401	15	347	-.322	.081	-.037	-.653	15	405	.043	.104	.451	-.265
15	222	-.216	.038	-.114	-.443	15	348	-.069	.085	.222	-.362	15	406	-.009	.101	.394	-.368
15	223	-.196	.042	-.061	-.411	15	349	-.022	.091	.357	-.372	15	407	-.788	.118	-.444	-1.279
15	224	-.223	.060	-.048	-.612	15	350	.019	.095	.394	-.306	15	408	.356	.139	.824	-.125
15	225	-.168	.043	.000	-.325	15	351	.056	.103	.403	-.287	15	409	-.745	.124	-.404	-1.498

APPENDIX A -- PRESSURE DATA:

C O L U M B I A P L A Z A , D E N V E R

WD	TAP	CPMEAN	CPRMS	CPMAX	CPMIN	WD	TAP	CPMEAN	CPRMS	CPMAX	CPMIN	WD	TAP	CPMEAN	CPRMS	CPMAX	CPMIN
15	410	.370	.153	.839	-.232	30	19	-.174	.050	-.042	-.424	30	110	-.505	.084	-.191	-1.108
15	411	.326	.115	.692	-.005	30	20	-.240	.086	-.029	-.842	30	111	-.439	.086	-.136	-.956
15	412	.247	.107	.632	-.076	30	21	-.027	.093	.364	-.594	30	112	-.451	.102	-.141	-.943
15	413	.086	.194	.523	-.229	30	22	-.166	.039	-.042	-.365	30	113	-.407	.059	-.205	-.671
15	414	-.716	.125	-.404	-1.398	30	23	-.210	.052	-.040	-.466	30	114	-.530	.112	-.240	-1.139
15	415	-.406	.169	.076	-1.021	30	24	-.023	.109	.347	-.595	30	115	-.379	.054	-.212	-.700
15	416	-.148	.061	.066	-.419	30	25	-.136	.033	-.007	-.267	30	116	-.388	.054	-.212	-.760
15	417	-.208	.058	-.012	-.439	30	26	-.167	.036	-.042	-.310	30	117	-.417	.059	-.239	-.718
15	418	-.315	.072	.105	-.614	30	27	-.167	.041	-.011	-.287	30	118	-.506	.065	-.297	-.818
15	419	-.720	.195	.277	-1.939	30	28	-.043	.083	.314	-.301	30	119	-.428	.068	-.205	-.860
15	420	-.685	.187	.000	-1.525	30	29	.004	.141	.539	-.461	30	120	-.415	.064	-.245	-.824
15	421	-.374	.154	.076	-1.192	30	30	.083	.086	.507	-.142	30	121	-.425	.073	-.203	-1.075
15	422	-.259	.092	.026	-.736	30	31	.058	.062	.340	-.150	30	122	-.514	.080	-.246	-1.084
15	423	-.291	.067	-.088	-.575	30	32	.048	.077	.396	-.780	30	123	-.448	.079	-.183	-.927
15	424	-.570	.171	-.173	-1.485	30	33	-.178	.104	.102	-.901	30	124	-.459	.095	-.152	-1.133
15	425	-.602	.185	-.150	-1.424	30	34	-.214	.077	-.015	-.605	30	125	-.448	.077	-.230	-.807
15	426	-.371	.142	-.026	-.982	30	35	.104	.078	.640	-.157	30	126	-.525	.084	-.279	-.941
15	427	-.278	.094	-.052	-.766	30	36	-.045	.060	.310	-.105	30	127	-.447	.083	-.247	-1.012
15	428	-.432	.098	-.147	-1.032	30	37	-.128	.044	.035	-.300	30	128	-.453	.084	-.243	-.890
15	429	-.609	.195	-.110	-1.330	30	38	.079	.077	.439	-.365	30	129	-.465	.097	-.185	-.932
15	430	-.325	.107	-.026	-.806	30	39	.084	.056	.316	-.093	30	130	-.527	.076	-.312	-.826
15	431	-.268	.078	-.048	-.620	30	40	.045	.056	.270	-.121	30	131	-.420	.091	-.178	-.865
15	432	-.235	.061	-.026	-.495	30	41	-.073	.045	.117	-.201	30	132	-.444	.072	-.236	-.784
15	433	-.265	.066	-.043	-.514	30	42	-.094	.040	.057	-.223	30	133	-.457	.070	-.252	-.776
15	434	-.440	.096	-.179	-.880	30	43	.013	.081	.340	-.309	30	134	-.530	.078	-.308	-.928
15	435	-.185	.049	-.033	-.389	30	44	.015	.083	.270	-.428	30	135	-.427	.071	-.218	-.735
15	436	-.381	.085	-.142	-.843	30	45	-.018	.096	.351	-.413	30	136	-.423	.094	-.192	-.908
15	437	-.184	.046	-.029	-.353	30	46	.036	.121	.767	-.221	30	137	-.427	.078	-.111	-.852
15	438	-.162	.041	-.024	-.308	30	47	-.094	.114	.474	-.388	30	138	-.493	.104	-.187	-1.051
15	439	-.179	.041	-.038	-.344	30	48	-.097	.100	.191	-.787	30	139	-.443	.076	-.232	-.751
15	440	-.214	.047	-.047	-.426	30	49	-.211	.083	.038	-.574	30	140	-.418	.077	-.170	-.784
15	441	-.388	.080	-.153	-.771	30	50	-.107	.067	.262	-.334	30	141	-.375	.092	-.100	-.888
30	1	-.312	.063	-.044	-.541	30	51	-.034	.082	.362	-.271	30	142	-.528	.089	-.288	-1.055
30	2	-.354	.065	-.013	-.736	30	52	-.264	.047	-.092	-.472	30	143	-.451	.074	-.256	-.747
30	3	-.397	.091	.146	-.638	30	53	-.359	.103	-.106	-.914	30	144	-.431	.080	-.216	-.826
30	4	-.226	.122	.215	-.842	30	54	-.302	.062	-.096	-.627	30	145	-.415	.081	-.152	-.825
30	5	-.329	.063	-.060	-.541	30	55	-.310	.065	-.077	-.580	30	146	-.476	.101	-.224	-1.103
30	6	-.329	.107	.085	-.706	30	56	-.349	.086	-.147	-.661	30	147	-.411	.057	-.230	-.644
30	7	-.305	.058	-.066	-.530	30	57	-.338	.052	-.110	-.616	30	148	-.392	.082	-.119	-.795
30	8	-.322	.080	.029	-.633	30	58	-.314	.050	-.122	-.588	30	149	-.390	.076	-.060	-1.170
30	9	-.306	.058	-.102	-.543	30	59	-.298	.054	-.119	-.605	30	150	-.456	.096	-.103	-1.171
30	10	-.321	.072	-.030	-.388	30	101	-.365	.152	-.132	-1.280	30	151	-.373	.081	-.090	-.683
30	11	-.283	.066	-.064	-.394	30	102	-.643	.140	-.119	-1.158	30	152	-.380	.082	-.099	-.760
30	12	-.263	.077	.044	-.738	30	103	-.346	.130	-.183	-1.050	30	153	-.372	.080	-.096	-.903
30	13	-.290	.074	.029	-.376	30	104	-.381	.160	-.155	-1.215	30	154	-.444	.085	-.176	-1.077
30	14	-.256	.069	-.007	-.734	30	105	-.427	.106	-.083	-.914	30	155	-.412	.035	-.303	-.533
30	15	-.301	.095	.031	-.722	30	106	-.495	.137	-.068	-1.150	30	156	-.388	.080	-.161	-.906
30	16	-.278	.080	.013	-.817	30	107	-.476	.143	-.031	-1.183	30	157	-.362	.067	-.138	-.669
30	17	-.198	.086	.121	-.552	30	108	-.441	.070	-.225	-.775	30	158	-.433	.071	-.226	-.749
30	18	-.247	.057	.002	-.564	30	109	-.424	.072	-.221	-.916	30	159	-.396	.050	-.243	-.626

APPENDIX A -- PRESSURE DATA

C O L U M B I A P L A Z A , D E N V E R

WD	TAP	CPNEAN	CPRMS	CPMAX	CPMIN	WD	TAP	CPNEAN	CPRMS	CPMAX	CPMIN	WD	TAP	CPNEAN	CPRMS	CPMAX	CPMIN
30	160	-.366	.044	-.234	-.537	30	210	-.328	.039	-.186	-.471	30	326	-.229	.049	-.028	-.826
30	161	-.367	.044	-.236	-.517	30	211	-.309	.036	-.186	-.455	30	327	-.205	.065	.044	-.985
30	162	-.431	.046	-.277	-.582	30	212	-.328	.040	-.206	-.481	30	328	-.230	.113	.145	-1.092
30	163	-.343	.041	-.218	-.481	30	213	-.309	.039	-.208	-.482	30	329	-.492	.144	.155	-1.010
30	164	-.337	.042	-.168	-.490	30	214	-.314	.043	-.141	-.532	30	330	-.338	.091	-.125	-.821
30	165	-.348	.036	-.227	-.493	30	215	-.314	.039	-.179	-.459	30	331	-.317	.105	.225	-.707
30	166	-.423	.042	-.279	-.613	30	216	-.324	.042	-.165	-.517	30	332	-.330	.087	-.082	-.719
30	167	-.403	.061	-.140	-.871	30	217	-.295	.039	-.180	-.466	30	333	-.173	.054	.030	-.478
30	168	-.398	.055	-.175	-.678	30	218	-.289	.050	-.160	-.681	30	334	-.146	.078	.192	-.696
30	169	-.396	.051	-.207	-.660	30	219	-.278	.060	-.115	-.676	30	335	-.172	.127	.328	-.885
30	170	-.461	.051	-.297	-.697	30	220	-.316	.047	-.163	-.500	30	336	-.323	.114	.194	-.866
30	171	-.368	.044	-.165	-.575	30	221	-.285	.043	-.149	-.501	30	347	-.095	.102	.330	-.504
30	172	-.361	.046	-.155	-.526	30	222	-.275	.046	-.137	-.504	30	348	.069	.115	.474	-.443
30	173	-.355	.045	-.187	-.517	30	223	-.252	.051	-.108	-.488	30	349	.092	.125	.516	-.396
30	174	-.423	.051	-.226	-.635	30	224	-.261	.058	-.026	-.574	30	350	.117	.128	.574	-.377
30	175	-.418	.068	-.225	-.700	30	225	-.278	.059	-.069	-.532	30	351	.137	.129	.702	-.383
30	176	-.425	.065	-.241	-.727	30	226	-.251	.048	-.061	-.415	30	352	.144	.133	.742	-.462
30	177	-.409	.063	-.224	-.730	30	227	-.255	.048	-.075	-.431	30	353	.188	.151	.593	-.450
30	178	-.390	.059	-.224	-.645	30	228	-.339	.077	-.132	-.857	30	354	.212	.160	.611	-.477
30	179	-.386	.058	-.134	-.658	30	229	-.267	.053	-.083	-.473	30	355	-.025	.108	.502	-.469
30	180	-.346	.051	-.113	-.532	30	230	-.277	.042	-.078	-.434	30	356	.233	.131	.646	-.224
30	181	-.322	.032	-.087	-.342	30	231	-.232	.043	-.073	-.448	30	357	.362	.158	.818	-.185
30	182	-.297	.031	-.148	-.349	30	232	-.291	.054	-.103	-.534	30	358	.319	.168	.798	-.659
30	183	-.403	.067	-.134	-.668	30	233	-.290	.067	-.066	-.676	30	359	-.048	.133	.430	-.462
30	184	-.400	.077	-.104	-.782	30	234	-.333	.090	-.033	-.893	30	360	.296	.168	.831	-.217
30	185	-.310	.073	-.078	-.573	30	301	-.357	.102	-.105	-1.240	30	361	.336	.180	.900	-.108
30	186	-.330	.092	-.064	-.709	30	302	-.545	.136	-.164	-1.067	30	362	.392	.183	.956	-.099
30	187	-.412	.072	-.223	-.737	30	303	-.551	.145	-.109	-1.276	30	363	.410	.175	.888	-.026
30	188	-.403	.072	-.173	-.740	30	304	-.528	.169	-.009	-1.465	30	364	.393	.176	.926	-.037
30	189	-.414	.077	-.200	-.810	30	305	-.552	.133	-.246	-1.428	30	365	.353	.181	.921	-.113
30	190	-.382	.069	-.148	-.704	30	306	-.536	.144	-.180	-1.944	30	366	.182	.204	.789	-.423
30	191	-.317	.064	-.091	-.543	30	307	-.581	.201	-.160	-1.673	30	367	-.037	.145	.507	-.500
30	192	-.271	.061	-.007	-.489	30	308	-.346	.070	-.165	-.583	30	368	.197	.164	.747	-.233
30	193	-.299	.073	-.031	-.589	30	309	.000	.000	.000	.000	30	369	.255	.160	.860	-.138
30	194	-.311	.089	-.021	-.806	30	310	.000	.000	.000	.000	30	370	.261	.147	.805	-.099
30	195	-.388	.065	-.166	-.648	30	311	.000	.000	.000	.000	30	371	.222	.121	.737	-.109
30	196	-.416	.067	-.201	-.675	30	312	.000	.000	.000	.000	30	372	.168	.112	.639	-.152
30	197	-.407	.080	-.194	-.884	30	313	-.335	.061	-.120	-.532	30	373	.079	.105	.558	-.260
30	198	-.361	.063	-.144	-.676	30	314	-.652	.171	-.009	-1.455	30	374	-.177	.107	.280	-.553
30	199	-.291	.060	-.028	-.563	30	315	-.321	.052	-.146	-.634	30	375	-.090	.120	.474	-.439
30	200	-.307	.057	-.010	-.536	30	316	-.242	.042	-.042	-.436	30	376	.089	.125	.611	-.259
30	201	-.402	.082	-.177	-.830	30	317	-.206	.075	.007	-.774	30	377	.114	.123	.675	-.206
30	202	-.301	.068	-.024	-.509	30	318	-.260	.189	.169	-1.062	30	378	.137	.101	.632	-.121
30	203	-.342	.076	-.108	-.669	30	319	-.587	.173	.109	-1.218	30	379	.118	.083	.584	-.218
30	204	-.363	.075	-.110	-.718	30	320	-.294	.064	-.131	-.796	30	380	.069	.084	.492	-.196
30	205	-.328	.073	-.085	-.705	30	321	-.245	.042	-.080	-.474	30	381	-.021	.089	.498	-.363
30	206	-.322	.069	-.099	-.664	30	322	-.196	.061	.030	-.518	30	382	-.306	.082	.066	-.639
30	207	-.312	.066	-.101	-.561	30	323	-.199	.138	.144	-.992	30	383	-.095	.075	.227	-.326
30	208	-.346	.064	-.153	-.732	30	324	-.525	.183	.154	-1.176	30	384	.079	.102	.596	-.151
30	209	-.310	.056	-.080	-.532	30	325	-.254	.058	-.070	-.680	30	385	.007	.080	.396	-.223

WD	TAP	CPMEAN	CPRMS	CPMAX	CPMIN	WD	TAP	CPMEAN	CPRMS	CPMAX	CPMIN	WD	TAP	CPMEAN	CPRMS	CPMAX	CPMIN
30	386	-.240	.078	106	- 384	45	3	-.347	.047	- 229	- 598	45	53	-.288	.049	- 115	- 604
30	387	-.084	.092	317	- 281	45	4	-.356	.064	- 085	- 691	45	54	-.335	.057	- 156	- 610
30	388	-.067	.074	675	- 180	45	5	-.340	.040	- 198	- 510	45	55	-.343	.056	- 182	- 605
30	389	.126	.096	839	- 194	45	6	-.351	.047	- 212	- 628	45	56	-.347	.056	- 198	- 684
30	390	.163	.089	738	- 123	45	7	-.333	.044	- 164	- 481	45	57	-.342	.040	- 164	- 544
30	391	.168	.085	612	- 101	45	8	-.348	.048	- 192	- 550	45	58	-.341	.042	- 183	- 499
30	392	.111	.087	645	- 118	45	9	-.344	.047	- 155	- 523	45	59	-.343	.046	- 198	- 553
30	393	.012	.088	408	- 244	45	10	-.360	.052	- 163	- 563	45	101	-.487	.125	- 166	-1 638
30	394	-.232	.075	054	- 570	45	11	-.351	.058	- 144	- 625	45	102	-.552	.119	- 195	-1 119
30	403	-.016	.187	547	- 890	45	12	-.354	.070	- 071	- 624	45	103	-.491	.130	- 155	-1 161
30	404	-.002	.111	408	- 485	45	13	-.349	.056	- 146	- 642	45	104	-.477	.140	- 089	-1 132
30	405	-.051	.099	331	- 432	45	14	-.352	.063	- 134	- 761	45	105	-.401	.111	- 038	- 852
30	406	-.199	.093	235	- 464	45	15	-.342	.056	- 106	- 706	45	106	-.452	.116	- 009	-1 020
30	407	-.555	.083	308	- 857	45	16	-.339	.071	- 098	- 751	45	107	-.484	.137	- 018	-1 015
30	408	-.091	.204	593	-1 060	45	17	-.337	.073	- 103	- 580	45	108	-.350	.057	- 170	- 636
30	409	-.505	.072	- 291	- 804	45	18	-.335	.073	- 020	- 715	45	109	-.353	.063	- 157	- 719
30	410	-.097	.271	673	- 905	45	19	-.120	.070	063	- 605	45	110	-.436	.083	- 193	- 958
30	411	-.072	.138	570	- 457	45	20	-.236	.106	040	- 898	45	111	-.372	.097	- 119	-1 096
30	412	-.022	.119	497	- 509	45	21	-.051	.100	085	- 337	45	112	-.383	.078	- 134	- 817
30	413	-.105	.098	239	- 487	45	22	-.111	.051	009	- 327	45	113	-.332	.049	- 177	- 575
30	414	-.451	.037	264	- 671	45	23	-.195	.069	054	- 531	45	114	-.450	.106	- 142	-1 159
30	415	-.565	.137	971	-1 320	45	24	-.053	.128	555	- 550	45	115	-.334	.040	- 218	- 501
30	416	-.263	.038	014	- 884	45	25	-.025	.041	106	- 225	45	116	-.344	.041	- 219	- 511
30	417	-.260	.052	109	- 527	45	26	-.125	.047	056	- 332	45	117	-.356	.037	- 218	- 497
30	418	-.320	.045	165	- 569	45	27	-.151	.054	027	- 443	45	118	-.440	.041	- 286	- 592
30	419	-.454	.063	282	- 809	45	28	-.006	.065	352	- 296	45	119	-.381	.047	- 229	- 582
30	420	-.587	.153	183	-1 215	45	29	-.071	.172	669	- 510	45	120	-.374	.042	- 223	- 583
30	421	-.308	.090	026	- 789	45	30	-.113	.096	539	- 330	45	121	-.370	.042	- 234	- 519
30	422	-.265	.057	035	- 502	45	31	-.071	.071	412	- 121	45	122	-.448	.045	- 295	- 614
30	423	-.304	.047	142	- 483	45	32	-.042	.108	397	- 724	45	123	-.372	.045	- 229	- 548
30	424	-.502	.092	264	-1 018	45	33	-.291	.142	067	-1 137	45	124	-.384	.055	- 217	- 690
30	425	-.435	.122	118	- 995	45	34	-.325	.111	060	- 799	45	125	-.377	.050	- 238	- 804
30	426	-.264	.075	054	- 640	45	35	-.125	.091	542	- 301	45	126	-.445	.048	- 295	- 754
30	427	-.215	.059	062	- 454	45	36	-.062	.069	419	- 131	45	127	-.378	.045	- 247	- 570
30	428	-.516	.077	298	-1 149	45	37	-.182	.050	000	- 429	45	128	-.385	.048	- 237	- 605
30	429	-.421	.128	090	- 903	45	38	-.097	.091	530	- 341	45	129	-.375	.041	- 231	- 555
30	430	-.243	.072	050	- 535	45	39	-.102	.074	549	- 119	45	130	-.413	.045	- 270	- 638
30	431	-.211	.055	045	- 433	45	40	-.054	.065	356	- 100	45	131	-.361	.043	- 229	- 505
30	432	-.210	.048	052	- 385	45	41	-.108	.042	058	- 270	45	132	-.336	.043	- 214	- 522
30	433	-.272	.045	089	- 463	45	42	-.133	.039	029	- 309	45	133	-.347	.041	- 222	- 512
30	434	-.537	.093	320	-1 043	45	43	-.024	.092	425	- 279	45	134	-.433	.046	- 279	- 583
30	435	-.174	.046	017	- 383	45	44	-.090	.098	468	- 247	45	135	-.374	.050	- 242	- 564
30	436	-.595	.095	260	- 858	45	45	-.090	.109	559	- 299	45	136	-.374	.053	- 217	- 620
30	437	-.171	.043	012	- 314	45	46	-.151	.119	717	- 118	45	137	-.373	.046	- 245	- 602
30	438	-.157	.033	009	- 299	45	47	-.095	.111	526	- 322	45	138	-.464	.060	- 297	- 716
30	439	-.183	.037	050	- 324	45	48	-.002	.101	330	- 535	45	139	-.337	.041	- 213	- 496
30	440	-.235	.042	096	- 403	45	49	-.179	.093	211	- 710	45	140	-.344	.044	- 190	- 516
30	441	-.514	.098	303	-1 101	45	50	-.037	.071	247	- 303	45	141	-.349	.056	- 202	- 629
45	1	-.346	.043	220	- 604	45	51	-.032	.085	484	- 268	45	142	-.409	.047	- 290	- 641
45	2	-.345	.043	207	- 574	45	52	-.237	.045	- 060	- 417	45	143	-.329	.040	- 227	- 512

APPENDIX A -- PRESSURE DATA:

C O L U M B I A P L A Z A , D E N V E R

WD	TAP	CPMEAN	CPRMS	CPMAX	CPMIN	WD	TAP	CPMEAN	CPRMS	CPMAX	CPMIN	WD	TAP	CPMEAN	CPRMS	CPMAX	CPMIN
45	144	.334	.044	-.208	-.558	45	194	-.359	.067	-.176	-.781	45	310	-.062	.077	.172	-.396
45	145	-.344	.046	-.202	-.568	45	195	-.319	.040	-.200	-.503	45	311	-.076	.079	.159	-.432
45	146	-.443	.063	-.226	-.765	45	196	-.343	.040	-.239	-.500	45	312	-.302	.148	.200	-.798
45	147	-.349	.058	-.168	-.622	45	197	-.327	.039	-.222	-.481	45	313	-.344	.055	-.160	-.547
45	148	-.346	.075	-.074	-.679	45	198	-.326	.038	-.216	-.481	45	314	-.261	.181	.407	-.880
45	149	-.353	.075	-.124	-.726	45	199	-.314	.040	-.179	-.473	45	315	-.298	.044	-.143	-.451
45	150	-.429	.077	-.193	-.796	45	200	-.339	.045	-.179	-.524	45	316	-.148	.047	.049	-.290
45	151	-.337	.066	-.113	-.618	45	201	-.310	.042	-.212	-.493	45	317	-.049	.059	.191	-.278
45	152	-.354	.071	-.136	-.770	45	202	-.311	.041	-.209	-.503	45	318	-.002	.117	.310	-.661
45	153	-.345	.072	-.139	-.688	45	203	-.323	.076	-.075	-.701	45	319	-.290	.150	.304	-.769
45	154	-.416	.077	-.155	-.844	45	204	-.345	.070	-.072	-.650	45	320	-.263	.053	.045	-.457
45	155	-.338	.028	-.249	-.483	45	205	-.333	.065	-.101	-.592	45	321	-.201	.037	-.014	-.356
45	156	-.331	.062	-.167	-.788	45	206	-.331	.061	-.117	-.597	45	322	-.138	.046	.142	-.307
45	157	-.339	.060	-.073	-.658	45	207	-.325	.058	-.139	-.586	45	323	-.127	.116	.308	-.729
45	158	-.410	.065	-.165	-.694	45	208	-.341	.066	-.110	-.701	45	324	-.429	.143	.308	-.925
45	159	-.335	.040	-.198	-.465	45	209	-.318	.051	-.127	-.511	45	325	-.242	.044	-.014	-.476
45	160	-.313	.040	-.174	-.464	45	210	-.316	.041	-.157	-.559	45	326	-.201	.042	-.042	-.361
45	161	-.308	.036	-.193	-.431	45	211	-.302	.039	-.153	-.466	45	327	-.165	.052	.079	-.400
45	162	-.380	.037	-.266	-.503	45	212	-.322	.043	-.177	-.462	45	328	-.191	.114	.108	-.753
45	163	-.318	.035	-.218	-.427	45	213	-.305	.040	-.170	-.450	45	329	-.470	.152	.189	-1.056
45	164	-.323	.038	-.185	-.442	45	214	-.303	.043	-.141	-.456	45	330	-.284	.089	-.065	-.982
45	165	-.330	.037	-.213	-.481	45	215	-.277	.038	-.089	-.440	45	331	-.271	.128	.166	-.846
45	166	-.405	.043	-.281	-.590	45	216	-.291	.044	-.060	-.438	45	332	-.286	.081	-.068	-.838
45	167	-.346	.042	-.139	-.554	45	217	-.264	.044	-.078	-.417	45	333	-.099	.048	.191	-.297
45	168	-.334	.050	-.121	-.576	45	218	-.257	.045	-.085	-.442	45	334	-.058	.063	.265	-.275
45	169	-.322	.043	-.106	-.497	45	219	-.245	.050	-.073	-.466	45	335	-.058	.110	.306	-.533
45	170	-.381	.045	-.193	-.528	45	220	-.268	.046	-.165	-.430	45	336	-.262	.131	.405	-.737
45	171	-.297	.036	-.150	-.467	45	221	-.248	.038	-.026	-.398	45	347	.127	.118	.603	-.280
45	172	-.298	.039	-.179	-.446	45	222	-.246	.039	-.078	-.430	45	348	.186	.119	.567	-.226
45	173	-.392	.036	-.182	-.497	45	223	-.231	.038	-.111	-.374	45	349	.173	.113	.502	-.276
45	174	-.380	.044	-.100	-.669	45	224	-.250	.044	-.093	-.428	45	350	.174	.111	.535	-.226
45	175	-.350	.042	-.229	-.512	45	225	-.298	.048	-.127	-.488	45	351	.162	.108	.516	-.185
45	176	-.333	.044	-.230	-.554	45	226	-.261	.043	-.110	-.449	45	352	.149	.111	.511	-.219
45	177	-.331	.039	-.181	-.481	45	227	-.249	.045	-.108	-.513	45	353	.143	.116	.582	-.309
45	178	-.311	.036	-.183	-.477	45	228	-.265	.073	-.012	-.978	45	354	.062	.115	.459	-.345
45	179	-.399	.039	-.182	-.478	45	229	-.291	.047	-.097	-.519	45	355	.202	.134	.675	-.266
45	180	-.287	.036	-.179	-.427	45	230	-.250	.043	-.099	-.411	45	356	.336	.133	.739	-.054
45	181	-.279	.037	-.160	-.486	45	231	-.233	.041	-.075	-.397	45	357	.283	.135	.674	-.186
45	182	-.267	.040	-.143	-.496	45	232	-.256	.051	-.072	-.500	45	358	.089	.137	.626	-.489
45	183	-.335	.044	-.198	-.507	45	233	-.237	.064	-.049	-.674	45	359	.145	.128	.617	-.285
45	184	-.330	.039	-.229	-.500	45	234	-.258	.080	.009	-.749	45	360	.416	.141	.859	.000
45	185	-.329	.047	-.183	-.493	45	301	-.486	.135	-.160	-1.178	45	361	.492	.148	.929	.115
45	186	-.368	.069	-.174	-.800	45	302	-.454	.112	-.193	-1.185	45	362	.509	.149	.936	.154
45	187	-.337	.042	-.222	-.512	45	303	-.472	.125	-.136	-1.110	45	363	.479	.142	.923	.133
45	188	-.319	.036	-.222	-.478	45	304	-.496	.145	-.125	-1.276	45	364	.426	.140	.857	.066
45	189	-.324	.037	-.221	-.484	45	305	-.458	.105	-.196	-.936	45	365	.302	.131	.780	-.049
45	190	-.312	.036	-.209	-.463	45	306	-.436	.104	-.109	-.920	45	366	-.093	.146	.528	-.540
45	191	-.332	.041	-.198	-.521	45	307	-.472	.159	-.103	-1.530	45	367	.078	.121	.549	-.273
45	192	-.324	.044	-.184	-.504	45	308	-.388	.070	-.167	-.647	45	368	.341	.143	.758	-.071
45	193	-.325	.049	-.190	-.503	45	309	-.147	.067	.066	-.467	45	369	.387	.139	.877	.066

WD	TAP	CPNEAN	CPRMS	CPMAX	CPMIN	WD	TAP	CPNEAN	CPRMS	CPMAX	CPMIN	WD	TAP	CPNEAN	CPRMS	CPMAX	CPMIN
45	370	.401	.137	.861	.058	45	428	-.396	.054	-.241	-.634	60	37	-.218	.050	-.060	-.413
45	371	.357	.172	.793	.021	45	429	-.676	.178	-.195	-1.447	60	38	.084	.066	.358	-.355
45	372	.289	.128	.744	-.089	45	430	-.374	.088	-.145	-.760	60	39	.112	.072	.460	-.033
45	373	.162	.116	.597	-.205	45	431	-.311	.067	-.144	-.646	60	40	.067	.061	.322	-.075
45	374	-.290	.088	.040	-.668	45	432	-.286	.056	-.111	-.518	60	41	-.127	.037	.007	-.287
45	375	-.009	.108	.470	-.276	45	433	-.320	.047	-.191	-.556	60	42	-.161	.036	-.013	-.318
45	376	.208	.116	.593	-.132	45	434	-.404	.050	-.275	-.704	60	43	-.004	.089	.352	-.376
45	377	.218	.118	.636	-.114	45	435	-.245	.047	-.098	-.458	60	44	.095	.091	.410	-.244
45	378	.237	.114	.644	-.095	45	436	-.370	.050	-.245	-.602	60	45	.103	.096	.486	-.245
45	379	.190	.117	.655	-.143	45	437	-.245	.044	-.065	-.398	60	46	.159	.108	.647	-.101
45	380	.156	.115	.635	-.144	45	438	-.220	.039	-.054	-.368	60	47	.015	.100	.476	-.281
45	381	.014	.102	.506	-.310	45	439	-.235	.036	-.102	-.358	60	48	.012	.085	.316	-.430
45	382	-.439	.085	.000	-.744	45	440	-.264	.038	-.111	-.403	60	49	-.104	.072	.212	-.457
45	383	-.004	.084	.396	-.204	45	441	-.396	.049	-.233	-.633	60	50	.028	.066	.314	-.351
45	384	.193	.114	.651	-.147	60	1	-.310	.043	-.161	-.451	60	51	-.006	.103	.494	-.294
45	385	-.022	.085	.338	-.254	60	2	-.316	.042	-.213	-.452	60	52	-.328	.091	-.011	-.669
45	386	-.401	.108	-.149	-.791	60	3	-.313	.043	-.206	-.452	60	53	-.414	.089	-.108	-.804
45	387	.011	.086	.410	-.218	60	4	-.320	.052	-.083	-.625	60	54	-.345	.053	-.184	-.559
45	388	.204	.113	.665	-.063	60	5	-.319	.038	-.201	-.453	60	55	-.330	.046	-.190	-.511
45	389	.262	.125	.751	-.049	60	6	-.326	.042	-.195	-.487	60	56	-.319	.047	-.191	-.522
45	390	.289	.125	.884	-.016	60	7	-.319	.042	-.190	-.496	60	57	-.322	.039	-.216	-.457
45	391	.242	.121	.798	-.053	60	8	-.326	.046	-.186	-.516	60	58	-.329	.043	-.195	-.518
45	392	.143	.107	.619	-.102	60	9	-.332	.049	-.188	-.557	60	59	-.340	.050	-.195	-.649
45	393	-.020	.095	.382	-.284	60	10	-.337	.051	-.178	-.595	60	101	-.571	.134	-.189	-1.208
45	394	-.394	.095	-.130	-.830	60	11	-.347	.058	-.148	-.615	60	102	-.659	.152	-.194	-1.314
45	403	-.467	.182	.302	-1.346	60	12	-.355	.069	-.140	-.726	60	103	-.558	.156	-.058	-1.360
45	404	-.170	.083	.167	-.537	60	13	-.332	.055	-.157	-.510	60	104	-.506	.160	-.007	-1.188
45	405	-.197	.078	.098	-.468	60	14	-.335	.054	-.178	-.610	60	105	-.438	.120	-.018	-1.045
45	406	-.239	.073	.063	-.508	60	15	-.311	.051	-.139	-.498	60	106	-.517	.130	.141	-1.074
45	407	-.440	.063	-.242	-.798	60	16	-.318	.054	-.125	-.546	60	107	-.620	.164	-.246	-1.418
45	408	-.441	.206	.301	-1.386	60	17	-.319	.054	-.051	-.501	60	108	-.362	.057	-.160	-.603
45	409	-.414	.053	-.261	-.689	60	18	-.323	.057	-.162	-.612	60	109	-.352	.069	-.158	-.787
45	410	-.631	.230	.263	-1.630	60	19	-.004	.067	.230	-.409	60	110	-.426	.086	-.196	-.893
45	411	-.162	.116	.195	-.914	60	20	-.122	.092	.145	-.619	60	111	-.356	.086	-.134	-1.034
45	412	-.169	.065	.171	-.393	60	21	.050	.086	.431	-.316	60	112	-.357	.083	-.120	-.835
45	413	-.261	.051	-.035	-.442	60	22	.009	.053	.219	-.147	60	113	-.338	.054	-.181	-.555
45	414	-.426	.041	-.298	-.590	60	23	-.077	.058	.157	-.283	60	114	-.415	.086	-.128	-1.021
45	415	-.902	.175	-.379	-1.556	60	24	.019	.102	.450	-.401	60	115	-.323	.045	-.194	-.534
45	416	-.507	.185	-.169	-1.210	60	25	.017	.050	.208	-.121	60	116	-.321	.045	-.182	-.512
45	417	-.358	.071	-.156	-.923	60	26	.006	.051	.211	-.206	60	117	-.333	.042	-.216	-.499
45	418	-.376	.044	-.219	-.557	60	27	-.036	.060	.255	-.250	60	118	-.408	.045	-.282	-.577
45	419	-.441	.042	-.298	-.683	60	28	-.025	.055	.296	-.226	60	119	-.339	.044	-.214	-.523
45	420	-.899	.201	-.386	-1.662	60	29	-.015	.119	.477	-.437	60	120	-.322	.051	-.142	-.499
45	421	-.513	.154	-.170	-1.242	60	30	.131	.096	.577	-.094	60	121	-.325	.045	-.189	-.495
45	422	-.385	.081	-.140	-.781	60	31	.115	.078	.432	-.080	60	122	-.414	.049	-.257	-.607
45	423	-.365	.048	-.237	-.546	60	32	.070	.102	.380	-.461	60	123	-.338	.046	-.190	-.556
45	424	-.433	.057	-.271	-.710	60	33	-.368	.147	.000	-1.409	60	124	-.334	.048	-.184	-.532
45	425	-.797	.203	-.293	-1.689	60	34	-.415	.117	-.129	-.994	60	125	-.316	.050	-.163	-.544
45	426	-.427	.107	-.145	-.870	60	35	.114	.079	.480	-.155	60	126	-.384	.049	-.244	-.581
45	427	-.317	.064	-.133	-.609	60	36	.070	.062	.362	-.129	60	127	-.325	.050	-.188	-.538

APPENDIX A -- PRESSURE DATA:

C O L U M B I A P L A Z A , D E N V E R

WD	TAP	CPMEAN	CPRMS	CPMAX	CPMIN	WD	TAP	CPMEAN	CPRMS	CPMAX	CPMIN	WD	TAP	CPMEAN	CPRMS	CPMAX	CPMIN
60	128	-.327	.052	-.173	-.556	60	178	-.301	.047	-.109	-.487	60	228	-.549	.278	.057	-1.824
60	129	-.337	.043	-.201	-.577	60	179	-.340	.050	-.137	-.573	60	229	-.311	.053	-.026	-.551
60	130	-.394	.049	-.257	-.601	60	180	-.315	.061	-.026	-.556	60	230	-.283	.054	-.068	-.476
60	131	-.326	.046	-.203	-.518	60	181	-.315	.081	.017	-.717	60	231	-.282	.061	-.021	-.541
60	132	-.318	.048	-.188	-.527	60	182	-.322	.114	.064	-.787	60	232	-.359	.104	.010	-.854
60	133	-.318	.045	-.210	-.501	60	183	-.323	.044	-.183	-.513	60	233	-.413	.173	.118	-1.247
60	134	-.392	.048	-.273	-.588	60	184	-.300	.039	-.196	-.471	60	234	-.574	.301	.144	-2.007
60	135	-.321	.047	-.208	-.514	60	185	-.357	.075	-.189	-.762	60	301	-.578	.167	-.170	-1.266
60	136	-.323	.050	-.202	-.576	60	186	-.355	.077	-.071	-.794	60	302	-.551	.135	-.210	-1.050
60	137	-.320	.045	-.203	-.526	60	187	-.318	.043	-.202	-.510	60	303	-.552	.126	-.225	-1.112
60	138	-.394	.050	-.260	-.645	60	188	-.299	.036	-.201	-.461	60	304	-.583	.156	-.231	-1.397
60	139	-.307	.044	-.172	-.471	60	189	-.301	.036	-.186	-.462	60	305	-.542	.123	-.246	-1.081
60	140	-.304	.046	-.157	-.479	60	190	-.293	.037	-.191	-.439	60	306	-.531	.143	-.212	-1.390
60	141	-.289	.049	-.178	-.506	60	191	-.329	.046	-.176	-.488	60	307	-.543	.211	-.042	-1.573
60	142	-.388	.050	-.235	-.594	60	192	-.325	.048	-.173	-.551	60	308	-.528	.095	-.214	-.859
60	143	-.308	.045	-.185	-.485	60	193	-.365	.077	-.167	-.771	60	309	-.009	.094	.352	-.361
60	144	-.306	.048	-.162	-.490	60	194	-.356	.077	-.102	-.805	60	310	.068	.104	.434	-.334
60	145	-.309	.046	-.192	-.481	60	195	-.301	.041	-.172	-.453	60	311	.068	.104	.426	-.295
60	146	-.388	.052	-.262	-.643	60	196	-.321	.037	-.200	-.452	60	312	.106	.169	.569	-.696
60	147	-.344	.056	-.143	-.576	60	197	-.304	.038	-.173	-.443	60	313	-.504	.096	-.243	-1.086
60	148	-.346	.075	-.049	-.760	60	198	-.304	.039	-.158	-.453	60	314	.229	.213	.837	-.611
60	149	-.367	.082	-.109	-.780	60	199	-.298	.039	-.163	-.465	60	315	-.444	.089	-.098	-.862
60	150	-.444	.088	-.101	-.825	60	200	-.331	.044	-.190	-.517	60	316	-.067	.077	.186	-.289
60	151	-.377	.088	-.128	-.826	60	201	-.296	.034	-.182	-.414	60	317	.070	.091	.406	-.246
60	152	-.371	.088	-.106	-.860	60	202	-.289	.035	-.158	-.439	60	318	.165	.108	.595	-.217
60	153	-.381	.099	-.100	-.858	60	203	-.477	.128	-.080	-1.103	60	319	.024	.191	.672	-.796
60	154	-.486	.115	-.172	-1.177	60	204	-.493	.117	-.096	-1.254	60	320	-.439	.127	.014	-1.042
60	155	-.336	.036	-.223	-.460	60	205	-.446	.101	-.092	-1.190	60	321	-.220	.064	.113	-.408
60	156	-.336	.069	-.109	-.689	60	206	-.429	.089	-.189	-1.061	60	322	-.118	.053	.147	-.320
60	157	-.376	.082	-.138	-.809	60	207	-.414	.077	-.194	-.853	60	323	-.070	.088	.187	-.639
60	158	-.492	.103	-.198	-.953	60	208	-.500	.130	-.096	-1.278	60	324	-.346	.125	.143	-.913
60	159	-.326	.045	-.194	-.527	60	209	-.409	.081	-.192	-1.768	60	325	-.450	.162	.012	-1.244
60	160	-.322	.046	-.182	-.512	60	210	-.493	.134	-.078	-1.278	60	326	-.218	.071	.061	-.499
60	161	-.321	.044	-.183	-.510	60	211	-.454	.099	-.024	-1.020	60	327	-.144	.061	.105	-.370
60	162	-.393	.050	-.253	-.594	60	212	-.465	.095	-.096	-1.259	60	328	-.148	.095	.132	-.656
60	163	-.330	.053	-.127	-.525	60	213	-.421	.079	-.154	-1.013	60	329	-.419	.141	.163	-1.008
60	164	-.340	.066	-.095	-.674	60	214	-.410	.078	-.113	-.830	60	330	-.624	.284	.023	-1.849
60	165	-.359	.079	-.098	-.657	60	215	-.426	.173	.170	-1.264	60	331	-.241	.133	.377	-.845
60	166	-.472	.115	-.048	-.999	60	216	-.487	.134	.031	-1.112	60	332	-.536	.221	.021	-1.517
60	167	-.307	.041	-.179	-.471	60	217	-.471	.114	-.062	-1.072	60	333	-.124	.065	.080	-.392
60	168	-.322	.042	-.160	-.516	60	218	-.443	.111	-.094	-1.139	60	334	-.053	.062	.201	-.257
60	169	-.319	.042	-.131	-.505	60	219	-.408	.119	.040	-.966	60	335	-.052	.101	.384	-.571
60	170	-.388	.052	-.200	-.645	60	220	-.359	.128	.202	-.854	60	336	-.259	.138	.390	-.837
60	171	-.297	.058	-.101	-.532	60	221	-.446	.144	.073	-1.027	60	347	.262	.136	.637	-.229
60	172	-.275	.071	.009	-.598	60	222	-.509	.163	-.035	-1.332	60	348	.199	.120	.562	-.242
60	173	-.252	.102	.118	-.771	60	223	-.470	.153	-.111	-1.389	60	349	.159	.114	.545	-.279
60	174	-.350	.180	.207	-.937	60	224	-.456	.151	-.039	-1.153	60	350	.144	.109	.557	-.259
60	175	-.298	.041	-.165	-.442	60	225	-.320	.058	-.121	-.587	60	351	.101	.098	.435	-.232
60	176	-.310	.045	-.160	-.470	60	226	-.302	.059	-.090	-.514	60	352	.068	.099	.390	-.242
60	177	-.308	.045	-.167	-.533	60	227	-.312	.069	-.123	-.579	60	353	.003	.101	.328	-.404

WD	TAP	CPNEAN	CPRMS	CPMAX	CPMIN	WD	TAP	CPNEAN	CPRMS	CPMAX	CPMIN	WD	TAP	CPNEAN	CPRMS	CPMAX	CPMIN
60	354	-156	102	180	-632	60	412	-314	980	-120	-1008	75	21	-007	080	368	-417
60	355	368	157	864	-117	60	413	-333	046	-170	-540	75	22	-055	080	445	-192
60	356	348	140	786	-078	60	414	-401	052	-265	-624	75	23	-078	073	226	-442
60	357	147	102	322	-187	60	415	-054	190	-592	-1935	75	24	008	073	296	-307
60	358	-199	111	161	-606	60	416	-698	221	-263	-1417	75	25	054	070	370	-149
60	359	346	156	878	-234	60	417	-467	109	-260	-1291	75	26	-011	050	226	-206
60	360	511	153	969	064	60	418	-399	066	-235	-904	75	27	-049	062	221	-279
60	361	519	153	1048	106	60	419	-381	056	-220	-714	75	28	-006	059	221	-309
60	362	506	147	1057	112	60	420	-386	216	-471	-2207	75	29	022	069	263	-245
60	363	423	126	893	084	60	421	-657	183	-216	-1333	75	30	003	105	338	-537
60	364	337	117	774	-005	60	422	-466	101	-214	-1045	75	31	004	094	253	-588
60	365	167	103	508	-158	60	423	-392	054	-239	-663	75	32	025	090	307	-380
60	366	-344	111	933	-723	60	424	-378	055	-170	-577	75	33	-267	102	018	-1021
60	367	125	112	745	-309	60	425	-902	248	-333	-1974	75	34	-320	083	-093	-867
60	368	361	145	856	-019	60	426	-515	126	-198	-1185	75	35	021	106	436	-355
60	369	428	157	1027	052	60	427	-385	073	-149	-767	75	36	013	053	210	-236
60	370	429	150	956	070	60	428	-371	050	-229	-602	75	37	-182	038	-045	-348
60	371	356	130	766	014	60	429	-891	210	-356	-1930	75	38	014	123	303	-823
60	372	266	117	652	-061	60	430	-467	088	-228	-948	75	39	022	080	255	-380
60	373	093	098	515	-229	60	431	-393	077	-197	-797	75	40	009	052	201	-234
60	374	-414	091	037	-739	60	432	-340	061	-177	-645	75	41	-128	035	016	-239
60	375	029	099	478	-265	60	433	-355	049	-223	-620	75	42	-151	033	-018	-263
60	376	238	127	732	-052	60	434	-389	047	-274	-621	75	43	018	089	344	-324
60	377	259	119	727	-085	60	435	-284	042	-112	-448	75	44	032	107	426	-422
60	378	279	115	735	000	60	436	-358	045	-233	-589	75	45	016	100	453	-339
60	379	233	112	629	-068	60	437	-279	043	-129	-542	75	46	112	088	577	-106
60	380	137	107	526	-101	60	438	-252	038	-117	-481	75	47	015	083	326	-284
60	381	-006	096	396	-260	60	439	-266	037	-133	-434	75	48	-082	101	188	-532
60	382	-523	093	-181	-877	60	440	-288	039	-143	-462	75	49	-101	075	167	-432
60	383	018	074	335	-181	60	441	-383	045	-262	-602	75	50	021	112	338	-475
60	384	137	112	636	-067	75	1	-263	028	-172	-373	75	51	001	087	362	-362
60	385	-039	082	359	-272	75	2	-270	028	-179	-387	75	52	-171	074	095	-563
60	386	-491	112	-186	-950	75	3	-266	027	-181	-402	75	53	-349	080	-114	-745
60	387	927	076	530	-190	75	4	-262	036	-040	-393	75	54	-300	046	-150	-506
60	388	195	111	689	-057	75	5	-269	029	-176	-377	75	55	-282	044	-103	-559
60	389	246	124	799	-005	75	6	-266	033	-155	-414	75	56	-266	044	-102	-574
60	390	272	125	817	016	75	7	-269	033	-172	-391	75	57	-271	029	-176	-399
60	391	230	116	736	000	75	8	-267	038	-148	-406	75	58	-276	034	-159	-422
60	392	152	100	565	-099	75	9	-288	039	-163	-437	75	59	-284	040	358	-465
60	393	-036	089	366	-325	75	10	-286	039	-168	-436	75	101	-644	189	-092	-1184
60	394	-462	102	-248	-927	75	11	-291	046	-154	-487	75	102	-728	185	-145	-1351
60	393	-584	223	-241	-1696	75	12	-290	047	-148	-481	75	103	-543	144	-077	-1079
60	404	-387	191	-122	-1048	75	13	-274	042	-111	-459	75	104	-450	167	022	-1117
60	405	-370	069	-113	-664	75	14	-282	040	-161	-458	75	105	-298	088	-013	-618
60	406	-370	066	-097	-672	75	15	-253	039	-087	-416	75	106	-389	112	011	-859
60	407	-434	068	-225	-783	75	16	-258	042	-095	-419	75	107	-859	216	-153	-1673
60	406	-577	233	-048	-1773	75	17	-261	041	-060	-444	75	108	-299	063	-082	-590
60	409	-411	055	-223	-607	75	18	-262	043	-128	-478	75	109	-292	066	-088	-624
60	410	-386	194	-407	-1860	75	19	045	100	387	-733	75	110	-372	068	-162	-663
60	411	-523	241	-103	-1336	75	20	-108	100	148	-609	75	111	-300	064	-115	-775

APPENDIX A -- PRESSURE DATA:

C O L U M B I A P L A Z A , D E N V E R

WD	TAP	CPMEAN	CPRMS	CPMAX	CPMIN	WD	TAP	CPMEAN	CPRMS	CPMAX	CPMIN	WD	TAP	CPMEAN	CPRMS	CPMAX	CPMIN
75	112	-.298	.064	-.096	-.536	75	162	-.388	.062	-.169	-.692	75	212	-.593	.248	-.034	-1.705
75	113	-.291	.052	-.133	-.526	75	163	-.345	.074	-.191	-.678	75	213	-.645	.248	-.019	-1.747
75	114	-.373	.066	-.133	-.641	75	164	-.367	.090	-.045	-.826	75	214	-.664	.229	-.045	-1.940
75	115	-.263	.052	-.088	-.556	75	165	-.429	.108	-.043	-.842	75	215	-.383	.107	.100	-.834
75	116	-.251	.049	-.129	-.432	75	166	-.691	.154	-.096	-1.242	75	216	-.357	.187	.097	-1.148
75	117	-.290	.041	-.177	-.496	75	167	-.246	.037	-.126	-.394	75	217	-.411	.237	.210	-1.361
75	118	-.366	.045	-.231	-.554	75	168	-.262	.041	-.120	-.438	75	218	-.521	.245	.157	-1.771
75	119	-.286	.042	-.142	-.504	75	169	-.277	.041	-.124	-.454	75	219	-.493	.197	.216	-1.571
75	120	-.247	.043	-.089	-.476	75	170	-.363	.043	-.187	-.730	75	220	-.359	.092	.097	-.848
75	121	-.243	.037	-.128	-.436	75	171	-.320	.054	-.034	-.568	75	221	-.195	.108	.195	-.820
75	122	-.343	.040	-.194	-.538	75	172	-.341	.067	-.045	-.732	75	222	-.222	.185	.271	-1.272
75	123	-.275	.037	-.167	-.459	75	173	-.384	.094	-.076	-.912	75	223	-.314	.250	.173	-1.426
75	124	-.263	.039	-.131	-.434	75	174	-.390	.168	-.076	-1.235	75	224	-.417	.240	.191	-1.676
75	125	-.279	.041	-.153	-.530	75	175	-.269	.045	-.142	-.563	75	225	-.274	.046	-.148	-.510
75	126	-.336	.038	-.225	-.661	75	176	-.280	.044	-.136	-.503	75	226	-.216	.041	-.067	-.468
75	127	-.276	.034	-.164	-.408	75	177	-.282	.046	-.090	-.533	75	227	-.184	.046	-.036	-.546
75	128	-.281	.036	-.147	-.427	75	178	-.279	.047	-.097	-.504	75	228	-.245	.230	.407	-1.577
75	129	-.283	.037	-.139	-.465	75	179	-.345	.064	-.153	-.640	75	229	-.271	.048	-.114	-.501
75	130	-.351	.035	-.247	-.505	75	180	-.367	.080	-.136	-.827	75	230	-.210	.044	-.014	-.352
75	131	-.282	.031	-.185	-.423	75	181	-.444	.116	-.164	-1.106	75	231	-.174	.045	.012	-.345
75	132	-.279	.035	-.154	-.467	75	182	-.556	.152	-.154	-1.212	75	232	-.174	.067	.109	-.497
75	133	-.272	.030	-.184	-.377	75	183	-.298	.039	-.172	-.489	75	233	-.153	.106	.174	-.839
75	134	-.346	.031	-.247	-.461	75	184	-.273	.032	-.164	-.420	75	234	-.245	.231	.297	-1.581
75	135	-.273	.028	-.151	-.376	75	185	-.343	.071	-.178	-.659	75	301	-.577	.158	-.033	-1.159
75	136	-.276	.032	-.167	-.418	75	186	-.314	.062	-.166	-.589	75	302	-.685	.179	-.033	-1.240
75	137	-.269	.027	-.166	-.389	75	187	-.295	.036	-.165	-.475	75	303	-.658	.207	-.106	-1.259
75	138	-.348	.031	-.216	-.510	75	188	-.276	.031	-.184	-.412	75	304	-.879	.208	-.174	-1.567
75	139	-.261	.030	-.167	-.376	75	189	-.277	.032	-.183	-.407	75	305	-.948	.191	-.192	-1.882
75	140	-.255	.031	-.147	-.376	75	190	-.265	.033	-.169	-.399	75	306	-.611	.157	-.222	-1.658
75	141	-.234	.026	-.148	-.404	75	191	-.294	.041	-.143	-.501	75	307	-.511	.233	.066	-1.770
75	142	-.335	.032	-.227	-.483	75	192	-.284	.040	-.148	-.484	75	308	-.793	.241	.052	-1.741
75	143	-.259	.027	-.169	-.360	75	193	-.340	.070	-.147	-.725	75	309	.095	.175	.665	-.612
75	144	-.253	.031	-.149	-.378	75	194	-.311	.061	-.159	-.623	75	310	.161	.174	.723	-.496
75	145	-.255	.025	-.155	-.449	75	195	-.276	.030	-.164	-.397	75	311	.139	.159	.619	-.497
75	146	-.335	.031	-.236	-.585	75	196	-.291	.030	-.194	-.392	75	312	.240	.179	.799	-.554
75	147	-.307	.056	-.126	-.579	75	197	-.273	.028	-.179	-.377	75	313	-.941	.285	.118	-2.365
75	148	-.317	.084	-.045	-.910	75	198	-.273	.028	-.166	-.383	75	314	.406	.206	1.043	-.858
75	149	-.340	.093	-.045	-.982	75	199	-.260	.030	-.145	-.385	75	315	-.727	.281	.384	-1.988
75	150	-.443	.100	-.169	-1.017	75	200	-.288	.035	-.165	-.448	75	316	-.133	.104	.323	-.471
75	151	-.406	.107	-.133	-.872	75	201	-.271	.032	-.138	-.393	75	317	-.025	.097	.404	-.364
75	152	-.474	.139	-.120	-1.302	75	202	-.258	.031	-.143	-.361	75	318	-.053	.112	.461	-.372
75	153	-.545	.189	-.022	-1.808	75	203	-.508	.187	-.057	-1.639	75	319	-.055	.221	.591	-.995
75	154	-.716	.232	-.145	-1.787	75	204	-.548	.224	-.017	-1.783	75	320	-.547	.227	.325	-1.692
75	155	-.297	.034	-.198	-.484	75	205	-.613	.238	-.133	-1.437	75	321	-.179	.089	.239	-.830
75	156	-.306	.070	-.098	-.715	75	206	-.767	.246	-.178	-1.605	75	322	-.097	.071	.180	-.430
75	157	-.520	.165	-.119	-1.399	75	207	-.954	.323	-.287	-2.390	75	323	-.114	.114	.280	-.645
75	158	-.697	.213	-.189	-1.722	75	208	-.512	.159	-.131	-1.400	75	324	-.340	.159	.203	-1.141
75	159	-.275	.044	-.115	-.538	75	209	-.930	.324	-.200	-2.963	75	325	-.425	.294	.390	-1.634
75	160	-.286	.059	-.111	-.496	75	210	-.462	.148	.031	-1.315	75	326	-.094	.102	.274	-.472
75	161	-.299	.052	-.103	-.530	75	211	-.472	.204	.157	-1.404	75	327	-.061	.087	.268	-.372

APPENDIX A -- PRESSURE DATA:

C O L U M B I A P L A Z A , D E N V E R

WD	TAP	CPNEAN	CPRMS	CPMAX	CPMIN	WD	TAP	CPNEAN	CPRMS	CPMAX	CPMIN	WD	TAP	CPNEAN	CPRMS	CPMAX	CPMIN
75	328	- .089	.111	.252	- .634	75	388	.161	.086	.552	- .039	90	5	- .229	.039	- .104	- .430
75	329	- .331	.208	.196	-1.012	75	389	.222	.112	.729	- .072	90	6	- .248	.050	- .103	- .497
75	330	- .293	.248	.374	-1.394	75	390	.262	.121	.788	- .062	90	7	- .236	.043	- .097	- .481
75	331	- .121	.159	.266	- .777	75	391	.241	.115	.722	- .034	90	8	- .234	.049	- .091	- .492
75	332	- .147	.203	.325	-1.197	75	392	.164	.111	.612	- .134	90	9	- .254	.046	- .115	- .453
75	333	- .022	.073	.388	- .281	75	393	- .003	.092	.419	- .266	90	10	- .245	.045	- .105	- .439
75	334	- .014	.068	.271	- .363	75	394	- .413	.080	- .143	- .760	90	11	- .274	.065	- .135	- .618
75	335	- .048	.098	.235	- .621	75	403	-1.090	.212	- .473	-1.866	90	12	- .248	.050	- .097	- .463
75	336	- .148	.142	.238	- .801	75	404	- .597	.149	- .237	-1.109	90	13	- .254	.048	- .104	- .455
75	347	.240	.144	.722	- .311	75	405	- .461	.106	- .169	-1.153	90	14	- .252	.043	- .132	- .494
75	348	.107	.111	.476	- .299	75	406	- .393	.082	- .116	- .752	90	15	- .242	.047	- .093	- .449
75	349	.058	.102	.582	- .381	75	407	- .377	.068	- .173	- .672	90	16	- .234	.047	- .075	- .445
75	350	.035	.096	.522	- .334	75	408	-1.094	.243	- .399	-1.854	90	17	- .256	.050	- .101	- .489
75	351	- .011	.078	.256	- .337	75	409	- .366	.061	- .164	- .608	90	18	- .247	.052	- .060	- .452
75	352	- .041	.077	.250	- .427	75	410	-1.018	.181	- .537	-1.829	90	19	- .113	.081	.490	- .140
75	353	- .088	.075	.158	- .362	75	411	- .796	.233	- .245	-1.508	90	20	- .029	.050	.122	- .392
75	354	- .307	.081	- .030	- .613	75	412	- .591	.181	- .189	-1.219	90	21	- .007	.053	.189	- .286
75	355	.427	.165	.998	- .318	75	413	- .374	.093	- .099	- .975	90	22	.082	.069	.441	- .078
75	356	.335	.129	.829	- .276	75	414	- .352	.065	- .174	- .713	90	23	- .036	.044	.140	- .284
75	357	.010	.082	.322	- .296	75	415	- .962	.185	- .538	-1.637	90	24	.013	.042	.179	- .171
75	358	- .373	.101	- .007	- .709	75	416	- .762	.201	- .248	-1.483	90	25	.086	.058	.347	- .065
75	359	.223	.154	.720	- .332	75	417	- .513	.148	- .162	-1.114	90	26	.043	.043	.262	- .081
75	360	.380	.156	.891	- .082	75	418	- .381	.085	- .144	- .815	90	27	- .008	.035	.167	- .144
75	361	.456	.147	.859	- .194	75	419	- .325	.055	- .145	- .746	90	28	.015	.034	.193	- .204
75	362	.453	.142	.854	- .208	75	420	- .891	.177	- .451	-1.670	90	29	.009	.038	.230	- .207
75	363	.356	.114	.689	- .224	75	421	- .675	.173	- .286	-1.356	90	30	- .031	.082	.253	- .564
75	364	.254	.101	.575	- .273	75	422	- .453	.109	- .248	- .935	90	31	- .042	.086	.192	- .499
75	365	.063	.085	.348	- .229	75	423	- .354	.050	- .217	- .725	90	32	- .046	.062	.195	- .366
75	366	- .441	.096	- .094	- .896	75	424	- .343	.052	- .173	- .756	90	33	- .169	.061	.011	- .700
75	367	.059	.084	.341	- .292	75	425	- .833	.233	- .277	-1.904	90	34	- .230	.058	- .034	- .562
75	368	.306	.138	.792	- .054	75	426	- .402	.094	- .153	- .815	90	35	- .014	.074	.273	- .537
75	369	.373	.146	.884	- .009	75	427	- .310	.052	- .162	- .524	90	36	- .022	.060	.160	- .357
75	370	.383	.145	.919	- .035	75	428	- .330	.036	- .223	- .490	90	37	- .181	.046	- .034	- .437
75	371	.395	.125	.861	- .016	75	429	- .767	.168	- .296	-1.467	90	38	.002	.063	.239	- .472
75	372	.211	.108	.672	- .125	75	430	- .375	.065	- .169	- .750	90	39	.022	.050	.194	- .253
75	373	.048	.085	.371	- .184	75	431	- .318	.050	- .148	- .580	90	40	.019	.040	.179	- .131
75	374	- .414	.083	- .154	- .872	75	432	- .287	.042	- .128	- .483	90	41	- .098	.047	.140	- .254
75	375	.026	.082	.468	- .313	75	433	- .310	.034	- .201	- .481	90	42	- .115	.045	.114	- .268
75	376	.202	.119	.705	- .069	75	434	- .348	.033	- .245	- .495	90	43	- .093	.051	.190	- .431
75	377	.275	.141	.880	- .072	75	435	- .251	.039	- .076	- .420	90	44	.003	.053	.188	- .292
75	378	.308	.139	.827	- .030	75	436	- .322	.034	- .207	- .449	90	45	.005	.061	.266	- .261
75	379	.261	.117	.686	- .071	75	437	- .260	.038	- .079	- .388	90	46	- .061	.100	.186	- .582
75	380	.135	.100	.529	- .176	75	438	- .235	.035	- .046	- .343	90	47	.013	.062	.309	- .219
75	381	- .015	.077	.255	- .259	75	439	- .246	.033	- .055	- .351	90	48	.012	.067	.304	- .390
75	382	- .469	.072	- .266	- .730	75	440	- .264	.035	- .132	- .378	90	49	- .035	.051	.124	- .315
75	383	.024	.056	.278	- .237	75	441	- .337	.032	- .222	- .471	90	50	.049	.076	.304	- .291
75	384	.153	.088	.591	- .069	90	1	- .241	.041	- .133	- .466	90	51	.085	.068	.402	- .214
75	385	.000	.078	.315	- .241	90	2	- .250	.044	- .150	- .494	90	52	- .010	.050	.199	- .184
75	386	- .436	.086	- .194	- .831	90	3	- .245	.046	- .131	- .562	90	53	- .312	.097	- .038	- .718
75	387	.032	.060	.305	- .187	90	4	- .241	.050	- .093	- .470	90	54	- .283	.056	- .047	- .568

APPENDIX A -- PRESSURE DATA:

C O L U M B I A P L A Z A , D E N V E R

WD	TAP	CPMEAN	CPRMS	CPMAX	CPMIN	WD	TAP	CPMEAN	CPRMS	CPMAX	CPMIN	WD	TAP	CPMEAN	CPRMS	CPMAX	CPMIN
90	55	-.261	.051	-.111	-.478	90	146	-.305	.044	-.162	-.498	90	196	-.231	.040	-.115	-.367
90	56	-.244	.054	-.086	-.536	90	147	-.288	.069	-.127	-.564	90	197	-.223	.036	-.103	-.413
90	57	-.249	.049	-.119	-.633	90	148	-.310	.087	-.056	-.708	90	198	-.223	.037	-.110	-.408
90	58	-.259	.048	-.123	-.468	90	149	-.341	.102	-.054	-.906	90	199	-.227	.038	-.109	-.422
90	59	-.263	.049	-.077	-.456	90	150	-.461	.119	-.099	-1.100	90	200	-.235	.041	-.106	-.466
90	101	-.566	.176	-.122	-1.205	90	151	-.389	.122	-.118	-1.205	90	201	-.218	.039	-.106	-.401
90	102	-.291	.081	-.029	-.696	90	152	-.474	.138	-.148	-1.063	90	202	-.214	.033	-.100	-.356
90	103	-.241	.076	-.030	-.636	90	153	-.497	.158	-.140	-1.225	90	203	-.322	.076	-.118	-.598
90	104	-.230	.069	-.016	-.625	90	154	-.610	.178	-.222	-1.390	90	204	-.275	.059	-.084	-.528
90	105	-.166	.053	.016	-.353	90	155	-.286	.045	-.173	-.414	90	205	-.333	.082	-.101	-.821
90	106	-.337	.117	-.081	-.934	90	156	-.312	.083	-.094	-.733	90	206	-.526	.179	-.138	-1.222
90	107	-.796	.193	-.086	-1.488	90	157	-.479	.121	-.127	-.920	90	207	-.891	.240	-.034	-1.794
90	108	-.253	.068	-.047	-.596	90	158	-.631	.178	-.265	-1.549	90	208	-.317	.084	-.130	-.663
90	109	-.235	.051	-.086	-.579	90	159	-.250	.081	-.009	-.723	90	209	-.885	.246	-.134	-1.795
90	110	-.313	.049	-.164	-.561	90	160	-.273	.086	.058	-.627	90	210	-.308	.083	-.122	-.725
90	111	-.248	.050	-.109	-.559	90	161	-.322	.097	-.041	-.744	90	211	-.151	.062	.043	-.388
90	112	-.261	.063	-.090	-.575	90	162	-.440	.118	-.083	-.909	90	212	-.108	.069	.115	-.425
90	113	-.251	.063	-.047	-.655	90	163	-.436	.126	-.098	-.977	90	213	-.112	.090	.197	-.934
90	114	-.344	.071	-.157	-.682	90	164	-.455	.133	-.054	-1.043	90	214	-.384	.277	.359	-1.432
90	115	-.240	.071	-.061	-.693	90	165	-.498	.130	-.197	-1.114	90	215	-.289	.083	-.068	-.779
90	116	-.218	.048	-.036	-.467	90	166	-.384	.136	-.276	-1.268	90	216	-.061	.061	.168	-.341
90	117	-.228	.044	-.030	-.420	90	167	-.243	.088	-.009	-.725	90	217	-.003	.074	.228	-.350
90	118	-.313	.037	-.139	-.631	90	168	-.269	.091	.004	-.735	90	218	.028	.088	.336	-.542
90	119	-.253	.062	-.034	-.509	90	169	-.318	.107	.079	-.836	90	219	-.014	.163	.605	-.791
90	120	-.224	.067	-.031	-.629	90	170	-.436	.121	-.011	-1.024	90	220	-.328	.088	-.103	-.711
90	121	-.222	.054	-.061	-.579	90	171	-.439	.132	-.073	-1.095	90	221	-.082	.048	.151	-.283
90	122	-.304	.048	-.166	-.519	90	172	-.478	.142	-.130	-1.276	90	222	.004	.052	.217	-.177
90	123	-.242	.055	-.052	-.525	90	173	-.512	.150	-.129	-1.379	90	223	.038	.061	.258	-.200
90	124	-.247	.063	-.027	-.578	90	174	-.616	.158	-.200	-1.439	90	224	-.011	.132	.387	-.644
90	125	-.224	.055	-.077	-.574	90	175	-.199	.045	-.066	-.486	90	225	-.285	.085	-.079	-.612
90	126	-.293	.045	-.135	-.575	90	176	-.226	.057	-.054	-.530	90	226	-.159	.049	-.014	-.329
90	127	-.232	.046	-.123	-.489	90	177	-.293	.089	-.050	-.697	90	227	-.114	.044	.024	-.275
90	128	-.235	.050	-.063	-.521	90	178	-.339	.103	-.092	-.839	90	228	.095	.096	.516	-.233
90	129	-.237	.046	-.097	-.441	90	179	-.463	.144	-.067	-1.057	90	229	-.280	.083	-.053	-.662
90	130	-.299	.053	-.146	-.611	90	180	-.536	.149	-.118	-1.313	90	230	-.152	.047	.007	-.317
90	131	-.237	.047	-.089	-.564	90	181	-.562	.154	-.107	-1.260	90	231	-.106	.042	.060	-.241
90	132	-.201	.049	-.076	-.564	90	182	-.560	.150	-.169	-1.269	90	232	-.049	.049	.190	-.202
90	133	-.236	.044	-.113	-.495	90	183	-.236	.055	-.074	-.536	90	233	.022	.053	.247	-.134
90	134	-.308	.040	-.184	-.478	90	184	-.231	.055	-.067	-.487	90	234	.115	.093	.656	-.246
90	135	-.236	.039	-.114	-.414	90	185	-.466	.187	-.115	-1.398	90	301	-.266	.092	-.045	-.714
90	136	-.241	.044	-.110	-.445	90	186	-.426	.168	-.123	-1.235	90	302	-.240	.082	.024	-.707
90	137	-.228	.036	-.113	-.468	90	187	-.235	.059	-.050	-.692	90	303	-.590	.189	-.112	-1.227
90	138	-.310	.042	-.177	-.460	90	188	-.232	.052	-.067	-.487	90	304	-.790	.192	-.147	-1.421
90	139	-.224	.038	-.118	-.389	90	189	-.231	.056	-.067	-.546	90	305	-.756	.203	-.174	-1.659
90	140	-.222	.039	-.099	-.470	90	190	-.235	.056	-.060	-.605	90	306	-.434	.118	-.071	-1.074
90	141	-.200	.040	-.038	-.380	90	191	-.241	.057	-.043	-.584	90	307	-.214	.073	.050	-.591
90	142	-.304	.043	-.159	-.494	90	192	-.258	.060	-.072	-.581	90	308	-.209	.194	.346	-.835
90	143	-.227	.035	-.125	-.354	90	193	-.509	.169	-.153	-1.222	90	309	-.231	.182	.833	-.501
90	144	-.226	.039	-.094	-.366	90	194	-.480	.163	-.140	-1.418	90	310	.232	.195	.809	-.494
90	145	-.225	.038	-.127	-.396	90	195	-.230	.042	-.076	-.508	90	311	.166	.187	.766	-.610

WD	TAP	CPMEAN	CPRMS	CPMAX	CPMIN	WD	TAP	CPMEAN	CPRMS	CPMAX	CPMIN	WD	TAP	CPMEAN	CPRMS	CPMAX	CPMIN
90	312	.193	.196	.797	-.802	90	372	.914	.114	.633	-.413	90	430	-.318	.059	-.143	-.614
90	313	-.249	.199	.601	-1.217	90	373	-.968	.111	.418	-.425	90	431	-.277	.046	-.124	-.478
90	314	.182	.232	.852	-.859	90	374	-.350	.104	.121	-.762	90	432	-.253	.044	-.123	-.426
90	315	.068	.238	.774	-.963	90	375	-.987	.120	.197	-.596	90	433	-.270	.041	-.145	-.417
90	316	.296	.231	1.008	-.332	90	376	-.094	.132	.391	-.667	90	434	-.291	.050	-.129	-.492
90	317	.216	.195	.807	-.296	90	377	-.114	.153	.319	-.908	90	435	-.203	.053	-.005	-.377
90	318	.134	.148	.707	-.341	90	378	-.044	.129	.317	-.669	90	436	-.274	.054	-.082	-.533
90	319	-.033	.122	.470	-.534	90	379	.008	.105	.449	-.506	90	437	-.201	.047	.016	-.378
90	320	.176	.191	.731	-.667	90	380	-.026	.110	.461	-.475	90	438	-.181	.044	.104	-.333
90	321	.244	.194	.819	-.332	90	381	-.104	.118	.381	-.513	90	439	-.188	.040	-.009	-.343
90	322	.183	.152	.712	-.312	90	382	-.415	.098	.143	-.931	90	440	-.198	.040	-.027	-.360
90	323	.113	.104	.501	-.287	90	383	-.097	.098	.196	-.685	90	441	-.281	.051	-.104	-.493
90	324	-.011	.081	.251	-.482	90	384	-.118	.103	.141	-.627	105	1	-.228	.038	-.088	-.395
90	325	.204	.143	.632	-.356	90	385	-.146	.059	.164	-.547	105	2	-.240	.038	-.121	-.437
90	326	.252	.162	.807	-.227	90	386	-.347	.071	-.051	-.605	105	3	-.243	.038	-.120	-.407
90	327	.186	.130	.728	-.197	90	387	-.107	.108	.157	-.811	105	4	-.242	.042	-.119	-.396
90	328	.106	.089	.465	-.178	90	388	-.096	.101	.189	-.650	105	5	-.221	.043	-.090	-.413
90	329	-.017	.062	.193	-.265	90	389	-.077	.099	.252	-.644	105	6	-.247	.039	-.134	-.419
90	330	.175	.100	.731	-.102	90	390	-.043	.094	.393	-.524	105	7	-.239	.044	-.086	-.464
90	331	.008	.052	.204	-.190	90	391	-.024	.083	.515	-.314	105	8	-.246	.041	-.121	-.430
90	332	.179	.092	.584	-.074	90	392	-.063	.079	.519	-.364	105	9	-.258	.048	-.111	-.494
90	333	.189	.093	.601	-.074	90	393	-.140	.071	.427	-.413	105	10	-.243	.045	-.108	-.439
90	334	.148	.076	.428	-.135	90	394	-.311	.064	-.129	-.630	105	11	-.269	.049	-.120	-.545
90	335	.098	.052	.320	-.114	90	403	-.825	.258	-.276	-1.867	105	12	-.251	.046	-.083	-.515
90	336	.019	.052	.190	-.249	90	404	-.479	.131	-.155	-1.070	105	13	-.265	.043	-.149	-.539
90	347	-.327	.296	.453	-1.663	90	405	-.410	.106	-.143	-.938	105	14	-.258	.039	-.143	-.448
90	348	-.103	.128	.318	-.676	90	406	-.359	.087	-.083	-.797	105	15	-.255	.042	-.131	-.405
90	349	-.097	.134	.375	-.714	90	407	-.332	.069	-.129	-.816	105	16	-.245	.045	-.105	-.434
90	350	-.087	.136	.343	-.632	90	408	-.873	.304	-.255	-2.182	105	17	-.257	.048	-.113	-.562
90	351	-.088	.129	.349	-.560	90	409	-.349	.073	-.129	-.752	105	18	-.249	.049	.020	-.596
90	352	-.103	.130	.408	-.562	90	410	-.784	.210	-.296	-1.716	105	19	-.115	.096	.694	-.260
90	353	-.142	.128	.301	-.659	90	411	-.570	.183	-.170	-1.594	105	20	-.117	.077	.085	-.484
90	354	-.286	.108	.090	-.740	90	412	-.440	.148	.005	-1.423	105	21	-.087	.068	.169	-.481
90	355	-.244	.332	.691	-1.523	90	413	-.370	.102	.138	-1.074	105	22	.083	.070	.517	-.078
90	356	.027	.159	.517	-.842	90	414	-.342	.093	-.134	-.970	105	23	-.093	.045	.059	-.296
90	357	-.099	.136	.449	-.592	90	415	-.786	.175	-.363	-1.460	105	24	-.065	.058	.128	-.298
90	358	-.376	.126	.069	-1.005	90	416	-.475	.113	-.157	-.950	105	25	.088	.065	.447	-.068
90	359	-.217	.249	.532	-1.049	90	417	-.381	.078	-.152	-.835	105	26	.036	.048	.387	-.094
90	360	-.114	.234	.572	-1.065	90	418	-.333	.059	-.113	-.691	105	27	-.049	.038	.228	-.181
90	361	-.059	.163	.558	-.862	90	419	-.303	.062	-.083	-.920	105	28	-.036	.042	.119	-.197
90	362	-.026	.135	.563	-.627	90	420	-.766	.173	-.116	-1.526	105	29	-.039	.044	.278	-.366
90	363	-.034	.115	.465	-.394	90	421	-.420	.103	-.122	-1.019	105	30	-.150	.089	.161	-.522
90	364	-.076	.115	.444	-.465	90	422	-.337	.061	-.129	-.681	105	31	-.183	.106	.181	-.651
90	365	-.151	.124	.508	-.523	90	423	-.293	.042	-.147	-.460	105	32	-.087	.059	.116	-.322
90	366	-.414	.126	.054	-.949	90	424	-.279	.067	-.073	-.749	105	33	-.104	.043	.079	-.323
90	367	-.102	.148	.280	-.887	90	425	-.556	.145	-.189	-1.238	105	34	-.162	.044	.022	-.343
90	368	-.091	.166	.577	-.764	90	426	-.346	.070	-.134	-.628	105	35	-.158	.102	.147	-.597
90	369	-.043	.160	.468	-.730	90	427	-.284	.048	-.117	-.483	105	36	-.104	.082	.139	-.416
90	370	.004	.135	.558	-.646	90	428	-.265	.055	-.109	-.522	105	37	-.153	.050	.020	-.442
90	371	.040	.113	.510	-.399	90	429	-.494	.106	-.210	-1.017	105	38	-.127	.094	.146	-.533

APPENDIX A -- PRESSURE DATA

C O L U M B I A P L A Z A , D E N V E R

WD	TAP	CPMEAN	CPRMS	CPMAX	CPMIN	WD	TAP	CPMEAN	CPRMS	CPMAX	CPMIN	WD	TAP	CPMEAN	CPRMS	CPMAX	CPMIN
105	39	-.072	.097	.235	-.520	105	130	-.220	.041	-.058	-.386	105	180	-.554	.198	-.094	-1.364
105	40	-.019	.052	.280	-.179	105	131	-.224	.041	-.095	-.445	105	181	-.680	.197	-.125	-1.513
105	41	-.027	.065	.359	-.221	105	132	-.155	.041	-.029	-.306	105	182	-.701	.181	-.272	-1.541
105	42	-.031	.064	.455	-.197	105	133	-.162	.031	-.059	-.318	105	183	-.209	.063	-.017	-.508
105	43	-.080	.040	.090	-.242	105	134	-.242	.030	-.128	-.374	105	184	-.207	.063	.015	-.528
105	44	-.060	.049	.125	-.271	105	135	-.189	.030	-.077	-.356	105	185	-.512	.181	-.173	-1.494
105	45	-.075	.062	.167	-.289	105	136	-.224	.043	-.092	-.463	105	186	-.482	.176	-.156	-1.374
105	46	-.220	.125	.168	-.977	105	137	-.161	.026	-.066	-.255	105	187	-.207	.064	-.039	-.525
105	47	-.067	.084	.312	-.439	105	138	-.269	.042	-.128	-.484	105	188	-.206	.054	-.012	-.443
105	48	-.091	.066	.170	-.334	105	139	-.139	.036	-.011	-.300	105	189	-.221	.066	.067	-.535
105	49	-.061	.053	.187	-.307	105	140	-.147	.030	-.011	-.259	105	190	-.237	.072	.034	-.664
105	50	-.089	.067	.419	-.309	105	141	-.122	.030	-.009	-.262	105	191	-.254	.068	.000	-.513
105	51	.114	.065	.450	-.063	105	142	-.205	.040	-.052	-.388	105	192	-.264	.069	-.029	-.577
105	52	.004	.057	.237	-.179	105	143	-.135	.029	-.050	-.254	105	193	-.482	.162	-.118	-1.310
105	53	-.288	.085	-.063	-.695	105	144	-.142	.032	-.027	-.270	105	194	-.474	.173	-.158	-1.391
105	54	-.271	.051	-.121	-.585	105	145	-.149	.028	-.041	-.260	105	195	-.197	.060	-.005	-.559
105	55	-.257	.048	-.133	-.540	105	146	-.223	.031	-.092	-.334	105	196	-.196	.042	-.046	-.372
105	56	-.246	.051	-.094	-.540	105	147	-.408	.114	-.127	-.833	105	197	-.213	.050	.048	-.567
105	57	-.247	.046	-.113	-.447	105	148	-.435	.147	-.007	-.992	105	198	-.231	.052	-.019	-.614
105	58	-.260	.049	-.132	-.513	105	149	-.456	.147	-.016	-1.064	105	199	-.247	.055	-.024	-.569
105	59	-.264	.049	-.118	-.495	105	150	-.591	.157	-.034	-1.298	105	200	-.252	.058	-.039	-.542
105	101	-.719	.188	.009	-.920	105	151	-.584	.124	-.187	-1.008	105	201	-.179	.038	-.012	-.315
105	102	-.290	.127	.018	-.013	105	152	-.587	.132	-.173	-1.122	105	202	-.192	.034	-.070	-.299
105	103	-.213	.102	.005	-.020	105	153	-.613	.139	-.208	-1.385	105	203	-.430	.069	-.224	-.693
105	104	-.219	.108	.018	-.011	105	154	-.699	.140	-.291	-1.262	105	204	-.355	.056	-.185	-.557
105	105	-.199	.055	.009	-.404	105	155	-.433	.095	-.184	-.722	105	205	-.359	.052	-.157	-.552
105	106	-.679	.165	-.159	-1.200	105	156	-.472	.139	-.058	-.981	105	206	-.372	.094	-.125	-1.058
105	107	-.908	.142	-.508	-1.519	105	157	-.618	.119	-.264	-1.016	105	207	-.668	.191	.056	-1.325
105	108	-.297	.080	-.022	-.771	105	158	-.700	.129	-.332	-1.244	105	208	-.405	.064	-.224	-.610
105	109	-.282	.078	-.047	-.619	105	159	-.303	.100	-.041	-.788	105	209	-.623	.198	.022	-1.270
105	110	-.380	.100	-.114	-.859	105	160	-.327	.123	.038	-.839	105	210	-.413	.076	-.181	-.764
105	111	-.342	.113	-.034	-.847	105	161	-.386	.143	-.014	-.908	105	211	-.137	.060	.102	-.355
105	112	-.379	.122	-.085	-.870	105	162	-.351	.172	-.063	-1.166	105	212	-.049	.072	.204	-.268
105	113	-.293	.075	-.086	-.818	105	163	-.628	.141	-.168	-1.203	105	213	-.032	.121	.288	-.901
105	114	-.455	.137	-.096	-1.043	105	164	-.661	.130	-.209	-1.300	105	214	-.279	.284	.475	-1.301
105	115	-.326	.093	.048	-.978	105	165	-.642	.123	-.276	-1.177	105	215	-.409	.092	-.080	-.831
105	116	-.294	.071	-.063	-.594	105	166	-.723	.131	-.332	-1.354	105	216	-.062	.076	.207	-.280
105	117	-.301	.076	-.079	-.712	105	167	-.245	.097	.032	-.863	105	217	.040	.081	.351	-.259
105	118	-.381	.092	-.110	-.910	105	168	-.250	.117	.121	-.778	105	218	.068	.107	.501	-.455
105	119	-.322	.093	-.018	-.758	105	169	-.302	.164	.215	-.980	105	219	-.035	.243	.773	-.897
105	120	-.299	.091	-.031	-.778	105	170	-.425	.192	.045	-1.134	105	220	-.380	.108	.039	-.841
105	121	-.273	.069	-.045	-.675	105	171	-.501	.218	.014	-1.201	105	221	-.073	.070	.196	-.303
105	122	-.370	.093	-.119	-.830	105	172	-.607	.215	-.061	-1.415	105	222	.034	.068	.287	-.171
105	123	-.302	.099	-.048	-.910	105	173	-.729	.199	-.172	-1.416	105	223	.079	.081	.355	-.350
105	124	-.307	.097	-.027	-.913	105	174	-.861	.185	-.408	-1.621	105	224	.009	.202	.508	-.851
105	125	-.237	.066	-.025	-.617	105	175	-.208	.073	-.011	-.577	105	225	-.296	.090	-.063	-.737
105	126	-.289	.050	-.123	-.520	105	176	-.217	.076	.025	-.585	105	226	-.147	.056	.022	-.340
105	127	-.222	.050	-.079	-.497	105	177	-.217	.081	.051	-.549	105	227	-.090	.052	.102	-.275
105	128	-.235	.061	-.054	-.520	105	178	-.251	.098	.070	-.761	105	228	.116	.102	.426	-.676
105	129	-.234	.063	-.075	-.520	105	179	-.444	.185	.010	-1.272	105	229	-.286	.085	-.022	-.674

WD	TAP	CPMEAN	CPRMS	CPMAX	CPMIN	WD	TAP	CPMEAN	CPRMS	CPMAX	CPMIN	WD	TAP	CPMEAN	CPRMS	CPMAX	CPMIN
105	230	-.137	.054	.055	-.364	105	356	-.181	.163	.177	-.880	105	414	-.423	.121	-.109	-1.356
105	231	-.979	.052	.105	-.316	105	357	-.129	.060	.145	-.380	105	415	-.538	.125	-.153	-1.151
105	232	-.905	.060	.238	-.255	105	358	-.259	.077	-.033	-.729	105	416	-.479	.107	-.123	-.905
105	233	.069	.062	.313	-.126	105	359	-.528	.165	.014	-1.246	105	417	-.454	.109	-.090	-.877
105	234	.134	.097	.494	-.306	105	360	-.427	.229	.226	-1.045	105	418	-.405	.105	-.028	-.799
105	301	-.220	.079	-.043	-.587	105	361	-.251	.197	.249	-1.000	105	419	-.363	.091	-.069	-.820
105	302	-.237	.106	.033	-.619	105	362	-.126	.134	.235	-.882	105	420	-.526	.128	-.160	-1.150
105	303	-.786	.153	-.234	-1.414	105	363	-.078	.068	.172	-.493	105	421	-.423	.116	-.102	-1.051
105	304	-.921	.146	-.443	-1.422	105	364	-.106	.066	.167	-.368	105	422	-.336	.086	-.065	-.775
105	305	-.741	.146	-.328	-1.423	105	365	-.162	.061	.135	-.387	105	423	-.276	.054	-.088	-.523
105	306	-.378	.096	-.125	-.910	105	366	-.289	.078	.000	-.821	105	424	-.270	.071	-.025	-.704
105	307	-.189	.076	.040	-.491	105	367	-.425	.136	-.099	-1.201	105	425	-.534	.179	-.123	-1.292
105	308	.977	.150	.524	-.451	105	368	-.438	.146	.059	-1.021	105	426	-.271	.064	-.023	-.578
105	309	.160	.118	.565	-.287	105	369	-.362	.187	.295	-.995	105	427	-.228	.049	-.023	-.433
105	310	.132	.109	.489	-.245	105	370	-.241	.175	.261	-.993	105	428	-.189	.049	-.041	-.544
105	311	.059	.097	.392	-.297	105	371	-.193	.117	.326	-.682	105	429	-.379	.095	-.100	-.942
105	312	-.037	.096	.335	-.429	105	372	-.104	.096	.203	-.597	105	430	-.256	.051	.002	-.467
105	313	.115	.171	.708	-.487	105	373	-.150	.086	.221	-.575	105	431	-.230	.043	-.035	-.398
105	314	.013	.108	.369	-.369	105	374	-.318	.089	.007	-.767	105	432	-.215	.047	.018	-.398
105	315	.266	.185	.774	-.418	105	375	-.393	.136	-.031	-1.005	105	433	-.223	.046	-.065	-.407
105	316	.528	.144	.965	.071	105	376	-.389	.138	.132	-1.026	105	434	-.207	.045	-.070	-.467
105	317	.446	.134	1.050	.069	105	377	-.383	.154	.176	-1.026	105	435	-.097	.075	.308	-.398
105	318	.300	.110	.870	-.014	105	378	-.285	.150	.178	-.866	105	436	-.200	.062	.023	-.585
105	319	-.082	.082	.198	-.387	105	379	-.156	.125	.263	-.635	105	437	-.108	.065	.269	-.294
105	320	.292	.169	.830	-.363	105	380	-.153	.108	.190	-.618	105	438	-.102	.056	.181	-.288
105	321	.424	.127	.858	.057	105	381	-.189	.099	.346	-.601	105	439	-.114	.045	.086	-.285
105	322	.347	.113	.771	.026	105	382	-.375	.078	-.097	-.671	105	440	-.135	.043	.034	-.288
105	323	.216	.087	.562	-.042	105	383	-.370	.166	.073	-1.214	105	441	-.210	.059	-.023	-.581
105	324	-.090	.067	.130	-.382	105	384	-.335	.147	.118	-1.028	120	1	-.188	.039	-.032	-.315
105	325	.235	.128	.839	-.223	105	385	-.146	.051	.037	-.529	120	2	-.191	.039	-.016	-.314
105	326	.319	.121	.844	.014	105	386	-.298	.082	-.069	-.646	120	3	-.183	.037	-.047	-.350
105	327	.250	.107	.687	-.017	105	387	-.345	.153	.041	-1.268	120	4	-.181	.043	-.036	-.375
105	328	.135	.084	.465	-.104	105	388	-.305	.151	.113	-.933	120	5	-.194	.040	-.065	-.392
105	329	-.135	.065	.061	-.428	105	389	-.222	.147	.183	-.875	120	6	-.205	.044	-.061	-.409
105	330	.189	.094	.541	-.106	105	390	-.143	.122	.204	-.704	120	7	-.209	.048	-.025	-.518
105	331	-.092	.061	.135	-.404	105	391	-.075	.076	.181	-.544	120	8	-.207	.047	-.058	-.478
105	332	.207	.090	.569	-.017	105	392	-.100	.066	.178	-.488	120	9	-.238	.056	-.081	-.547
105	333	.230	.100	.603	-.007	105	393	-.143	.052	.072	-.364	120	10	-.241	.052	-.108	-.503
105	334	.192	.095	.539	-.014	105	394	-.243	.066	-.014	-.521	120	11	-.258	.059	-.090	-.547
105	335	.112	.075	.456	-.083	105	403	-.389	.106	-.188	-1.355	120	12	-.245	.067	-.085	-.696
105	336	-.076	.068	.177	-.351	105	404	-.372	.093	-.169	-1.022	120	13	-.230	.047	-.086	-.496
105	347	-.700	.163	-.135	-1.402	105	405	-.371	.085	-.132	-.852	120	14	-.227	.042	-.088	-.451
105	348	-.273	.138	.021	-.925	105	406	-.359	.082	-.095	-.768	120	15	-.211	.044	-.047	-.382
105	349	-.204	.070	.055	-.627	105	407	-.340	.080	-.116	-.776	120	16	-.200	.045	-.062	-.426
105	350	-.174	.058	.042	-.428	105	408	-.368	.114	-.155	-1.387	120	17	-.203	.047	-.036	-.464
105	351	-.147	.047	.038	-.338	105	409	-.358	.077	-.123	-.822	120	18	-.202	.050	-.047	-.436
105	352	-.147	.049	.061	-.326	105	410	-.410	.096	-.174	-1.172	120	19	.063	.068	.486	-.222
105	353	-.164	.054	.188	-.437	105	411	-.405	.092	-.164	-.903	120	20	-.125	.060	.114	-.696
105	354	-.227	.060	.049	-.576	105	412	-.408	.106	-.053	-1.019	120	21	-.178	.064	-.005	-.484
105	355	-.646	.182	.080	-1.319	105	413	-.416	.110	-.030	-1.294	120	22	.053	.072	.420	-.159

APPENDIX A -- PRESSURE DATA:

C O L U M B I A P L A Z A , D E N V E R

WD	TAP	CPMEAN	CPRMS	CPMAX	CPMIN	WD	TAP	CPMEAN	CPRMS	CPMAX	CPMIN	WD	TAP	CPMEAN	CPRMS	CPMAX	CPMIN
120	23	-.120	.046	.047	-.305	120	114	-.379	.102	-.131	-.908	120	164	-.616	.172	-.077	-1.306
120	24	-.156	.052	.022	-.388	120	115	-.289	.057	-.079	-.608	120	165	-.664	.136	-.134	-1.280
120	25	.056	.064	.345	-.106	120	116	-.278	.063	-.082	-.702	120	166	-.762	.135	-.310	-1.402
120	26	.002	.058	.305	-.153	120	117	-.274	.068	-.076	-.531	120	167	-.191	.066	.018	-.516
120	27	-.097	.049	.151	-.244	120	118	-.346	.076	-.128	-.667	120	168	-.167	.083	.166	-.596
120	28	-.112	.045	.056	-.274	120	119	-.278	.070	-.072	-.676	120	169	-.184	.104	.250	-.896
120	29	-.116	.040	.061	-.250	120	120	-.257	.067	-.040	-.549	120	170	-.269	.125	.128	-.997
120	30	-.207	.060	-.036	-.447	120	121	-.246	.065	-.058	-.569	120	171	-.318	.194	.088	-1.154
120	31	-.231	.063	.009	-.486	120	122	-.339	.090	-.058	-.904	120	172	-.442	.234	.082	-1.284
120	32	-.114	.040	.025	-.279	120	123	-.266	.085	-.049	-.669	120	173	-.637	.246	.065	-1.599
120	33	-.105	.037	.018	-.302	120	124	-.254	.076	-.033	-.598	120	174	-.832	.193	-.091	-1.557
120	34	-.146	.031	-.029	-.310	120	125	-.213	.058	.029	-.462	120	175	-.153	.044	.114	-.359
120	35	-.232	.061	.014	-.640	120	126	-.265	.049	-.089	-.498	120	176	-.155	.050	.051	-.337
120	36	-.145	.050	.040	-.330	120	127	-.207	.054	.013	-.465	120	177	-.155	.062	.210	-.438
120	37	-.130	.040	.002	-.304	120	128	-.209	.057	.018	-.503	120	178	-.166	.071	.133	-.630
120	38	-.217	.069	.016	-.534	120	129	-.204	.056	-.013	-.622	120	179	-.252	.132	.060	-1.065
120	39	-.173	.079	.088	-.502	120	130	-.211	.038	-.106	-.423	120	180	-.352	.177	.128	-1.345
120	40	-.034	.052	.143	-.237	120	131	-.226	.049	-.092	-.451	120	181	-.526	.224	-.018	-1.550
120	41	-.000	.071	.360	-.164	120	132	-.140	.038	-.020	-.427	120	182	-.673	.212	-.156	-1.760
120	42	-.009	.064	.251	-.177	120	133	-.145	.029	-.022	-.332	120	183	-.163	.045	-.014	-.366
120	43	-.088	.043	.084	-.362	120	134	-.230	.035	.104	-.531	120	184	-.159	.049	.016	-.424
120	44	-.110	.038	.025	-.274	120	135	-.188	.045	-.065	-.552	120	185	-.343	.112	-.097	-1.026
120	45	-.193	.057	.014	-.392	120	136	-.220	.052	-.060	-.591	120	186	-.397	.122	-.124	-.928
120	46	-.385	.124	.085	-.858	120	137	-.156	.032	-.058	-.448	120	187	-.160	.044	.000	-.414
120	47	-.217	.079	.253	-.486	120	138	-.290	.052	-.157	-.636	120	188	-.160	.046	.000	-.424
120	48	-.173	.053	.038	-.444	120	139	-.118	.039	.009	-.409	120	189	-.167	.054	.028	-.473
120	49	-.122	.067	.383	-.342	120	140	-.126	.030	.000	-.239	120	190	-.180	.056	.028	-.403
120	50	.008	.048	.247	-.276	120	141	-.125	.032	.016	-.279	120	191	-.204	.058	-.007	-.479
120	51	.035	.053	.305	-.154	120	142	-.183	.041	-.029	-.416	120	192	-.223	.058	-.026	-.485
120	52	.045	.069	.359	-.134	120	143	-.111	.026	-.011	-.236	120	193	-.327	.108	-.005	-.989
120	53	-.185	.074	.020	-.518	120	144	-.119	.030	-.007	-.237	120	194	-.373	.109	.044	-.970
120	54	-.250	.058	-.027	-.525	120	145	-.130	.027	-.047	-.263	120	195	-.153	.043	.025	-.337
120	55	-.225	.051	.016	-.606	120	146	-.217	.035	-.089	-.359	120	196	-.158	.036	.000	-.322
120	56	-.207	.051	-.022	-.507	120	147	-.272	.074	-.097	-.678	120	197	-.163	.047	.035	-.357
120	57	-.204	.046	-.043	-.444	120	148	-.281	.111	.000	-.912	120	198	-.176	.050	.074	-.450
120	58	-.225	.055	-.007	-.642	120	149	-.340	.134	.114	-.974	120	199	-.193	.053	.030	-.483
120	59	-.243	.060	-.068	-.671	120	150	-.480	.152	-.064	-1.059	120	200	-.207	.054	-.012	-.468
120	101	-.378	.118	-.080	-.919	120	151	-.514	.115	-.188	-1.104	120	201	-.128	.039	.095	-.281
120	102	-.220	.044	-.044	-.436	120	152	-.573	.113	-.195	-1.027	120	202	-.153	.036	-.032	-.293
120	103	-.147	.030	-.031	-.382	120	153	-.601	.124	-.261	-1.115	120	203	-.364	.059	-.173	-.546
120	104	-.133	.037	.000	-.379	120	154	-.682	.120	-.328	-1.154	120	204	-.257	.055	-.069	-.474
120	105	-.146	.036	-.013	-.299	120	155	-.280	.073	-.141	-.653	120	205	-.248	.061	.019	-.445
120	106	-.778	.117	-.425	-1.238	120	156	-.285	.114	-.031	-.821	120	206	-.206	.074	.104	-.440
120	107	-1.102	.209	-.175	-1.885	120	157	-.609	.110	-.319	-.988	120	207	-.074	.184	.548	-.825
120	108	-.249	.052	-.106	-.505	120	158	-.685	.124	-.359	-1.298	120	208	-.324	.054	-.109	-.549
120	109	-.229	.050	-.067	-.484	120	159	-.241	.071	-.045	-.611	120	209	.053	.189	.568	-.990
120	110	-.310	.065	-.122	-.609	120	160	-.226	.101	.089	-.733	120	210	-.367	.071	-.081	-.692
120	111	-.259	.072	-.047	-.572	120	161	-.253	.123	.074	-.899	120	211	-.016	.074	.324	-.231
120	112	-.286	.083	-.080	-.731	120	162	-.390	.170	.082	-1.021	120	212	-.108	.090	.435	-.171
120	113	-.250	.050	-.082	-.548	120	163	-.525	.185	-.013	-1.095	120	213	.190	.111	.533	-.250

APPENDIX A -- PRESSURE DATA:

C O L U M B I A P L A Z A , D E N V E R

WD	TAP	CPMEAN	CPRMS	CPMAX	CPMIN	WD	TAP	CPMEAN	CPRMS	CPMAX	CPMIN	WD	TAP	CPMEAN	CPRMS	CPMAX	CPMIN
120	214	.261	.208	.793	-.962	120	330	.107	.088	.547	-.182	120	390	-.308	.146	.120	-.905
120	215	-.366	.093	.135	-.748	120	331	-.200	.069	.035	-.465	120	391	-.184	.101	.149	-.707
120	216	-.007	.079	.474	-.268	120	332	.124	.085	.515	-.122	120	392	-.162	.074	.088	-.578
120	217	.114	.085	.503	-.130	120	333	.096	.084	.470	-.094	120	393	-.145	.059	.144	-.631
120	218	.179	.103	.526	-.083	120	334	.054	.077	.444	-.122	120	394	-.176	.045	.005	-.426
120	219	.259	.174	.811	-.459	120	335	-.024	.065	.275	-.226	120	403	-.308	.067	-.127	-.942
120	220	-.298	.099	.109	-.738	120	336	-.194	.072	.028	-.537	120	404	-.302	.065	-.121	-.713
120	221	-.024	.067	.362	-.262	120	347	-.811	.167	-.280	-1.532	120	405	-.309	.059	-.155	-.610
120	222	.066	.069	.376	-.159	120	348	-.659	.195	-.148	-1.285	120	406	-.309	.060	-.128	-.617
120	223	.119	.082	.546	-.187	120	349	-.424	.161	-.083	-1.171	120	407	-.291	.057	-.134	-.608
120	224	.162	.133	.799	-.579	120	350	-.288	.114	.021	-.893	120	408	-.292	.060	-.123	-.716
120	225	-.230	.070	.044	-.529	120	351	-.185	.052	-.049	-.541	120	409	-.306	.060	-.155	-.638
120	226	-.097	.052	.111	-.293	120	352	-.176	.046	-.012	-.482	120	410	-.383	.086	-.130	-.835
120	227	-.046	.053	.177	-.215	120	353	-.181	.040	-.035	-.439	120	411	-.352	.076	-.120	-.695
120	228	.105	.087	.549	-.238	120	354	-.202	.043	-.051	-.437	120	412	-.343	.075	-.114	-.757
120	229	-.210	.064	.107	-.510	120	355	-.813	.174	-.301	-1.544	120	413	-.348	.065	-.049	-.707
120	230	-.080	.050	.141	-.247	120	356	-.678	.193	-.064	-1.325	120	414	-.345	.066	-.135	-.752
120	231	-.028	.052	.170	-.182	120	357	-.179	.038	-.019	-.448	120	415	-.443	.097	-.198	-.861
120	232	.033	.059	.319	-.120	120	358	-.228	.046	-.084	-.488	120	416	-.379	.093	-.107	-.839
120	233	.084	.067	.392	-.141	120	359	-.659	.123	.289	-1.300	120	417	-.360	.088	.002	-.731
120	234	.119	.088	.503	-.221	120	360	-.687	.134	.113	-1.229	120	418	-.324	.085	.000	-.740
120	301	-.134	.035	-.021	-.302	120	361	-.587	.178	.076	-1.355	120	419	-.289	.073	-.014	-.615
120	302	-.146	.051	.072	-.407	120	362	-.459	.198	.110	-1.103	120	420	-.390	.111	-.055	-1.047
120	303	-.346	.163	-.143	-1.081	120	363	-.252	.142	.136	-.870	120	421	-.316	.092	-.074	-.779
120	304	-1.070	.180	-.447	-1.586	120	364	-.217	.114	.134	-.680	120	422	-.275	.070	-.051	-.571
120	305	-.710	.139	-.269	-1.362	120	365	-.212	.083	.038	-.607	120	423	-.236	.044	-.092	-.419
120	306	-.218	.058	-.061	-.558	120	366	-.271	.068	-.028	-.568	120	424	-.260	.073	-.011	-.649
120	307	-.086	.047	.073	-.261	120	367	-.583	.145	-.249	-1.276	120	425	-.380	.114	-.120	-.918
120	308	.269	.138	.730	-.219	120	368	-.605	.154	-.071	-1.238	120	426	-.238	.042	-.097	-.392
120	309	.033	.104	.394	-.397	120	369	-.361	.171	.071	-1.327	120	427	-.213	.036	-.094	-.339
120	310	.008	.092	.358	-.334	120	370	-.455	.170	.033	-1.147	120	428	-.185	.047	-.050	-.457
120	311	-.085	.078	.273	-.393	120	371	-.265	.142	.268	-.872	120	429	-.290	.056	-.129	-.553
120	312	-.232	.069	.075	-.485	120	372	-.222	.119	.228	-.800	120	430	-.241	.041	-.097	-.415
120	313	.413	.149	.937	-.175	120	373	-.220	.109	.135	-.711	120	431	-.226	.037	-.120	-.362
120	314	-.210	.078	.061	-.500	120	374	-.304	.086	.000	-.619	120	432	-.228	.045	-.078	-.393
120	315	.484	.162	.961	-.167	120	375	-.486	.149	-.169	-1.427	120	433	-.229	.044	-.074	-.423
120	316	.425	.139	.923	-.040	120	376	-.505	.150	-.080	-1.586	120	434	-.201	.044	-.028	-.420
120	317	.305	.115	.748	-.050	120	377	-.537	.144	-.100	-1.246	120	435	-.058	.071	.242	-.253
120	318	.137	.092	.526	-.147	120	378	-.449	.138	.005	-1.119	120	436	-.175	.057	.048	-.492
120	319	-.246	.067	.021	-.505	120	379	-.303	.126	.082	-.905	120	437	-.073	.065	.192	-.245
120	320	.371	.161	.866	-.108	120	380	-.268	.105	.088	-.825	120	438	-.078	.053	.216	-.232
120	321	.313	.136	.833	-.076	120	381	-.248	.091	.111	-.757	120	439	-.093	.043	.120	-.235
120	322	.212	.114	.619	-.129	120	382	-.304	.074	.021	-.659	120	440	-.122	.042	.055	-.284
120	323	.067	.091	.395	-.284	120	383	-.494	.166	-.126	-1.575	120	441	-.176	.051	-.018	-.529
120	324	-.256	.070	-.056	-.532	120	384	-.496	.152	-.021	-1.230	135	1	-.139	.062	.066	-.394
120	325	.195	.130	.732	-.290	120	385	-.152	.065	.160	-.541	135	2	-.148	.059	.068	-.389
120	326	.137	.104	.610	-.131	120	386	-.217	.056	.023	-.440	135	3	-.161	.053	.000	-.351
120	327	.068	.088	.440	-.230	120	387	-.495	.163	-.178	-1.379	135	4	-.165	.053	.029	-.367
120	328	-.041	.072	.242	-.322	120	388	-.483	.147	-.023	-1.285	135	5	-.185	.063	.032	-.468
120	329	-.262	.072	-.024	-.557	120	389	-.411	.160	.030	-1.388	135	6	-.199	.054	-.029	-.452

APPENDIX A -- PRESSURE DATA:

C O L U M B I A P L A Z A , D E N V E R

WD	TAP	CPMEAN	CPRMS	CPMAX	CPMIN	WD	TAP	CPMEAN	CPRMS	CPMAX	CPMIN	WD	TAP	CPMEAN	CPRMS	CPMAX	CPMIN
135	7	-245	.084	.007	-688	135	57	-177	.078	.138	-507	135	148	-209	.040	-.073	-.436
135	8	-251	.068	-.047	-542	135	58	-250	.097	.146	-.657	135	149	-215	.040	-.078	-.404
135	9	-330	.075	-.054	-792	135	59	-338	.099	.143	-.853	135	150	-297	.047	-.143	-.509
135	10	-341	.085	-.097	-693	135	101	-405	.147	-.133	-1.019	135	151	-338	.050	-.100	-.763
135	11	-374	.093	-.097	-829	135	102	-247	.043	-.055	-.503	135	152	-438	.119	-.156	-.892
135	12	-407	.113	-.054	-931	135	103	-164	.032	-.045	-.358	135	153	-602	.156	-.206	-1.246
135	13	-277	.070	-.066	-710	135	104	-138	.037	.009	-.346	135	154	-836	.182	-.401	-1.773
135	14	-268	.064	-.099	-529	135	105	-224	.050	-.062	-.437	135	155	-230	.024	-.143	-.346
135	15	-298	.056	-.020	-444	135	106	-781	.142	-.291	-1.691	135	156	-203	.039	-.064	-.454
135	16	-199	.048	-.036	-387	135	107	-1.241	.269	-.353	-2.482	135	157	-625	.162	-.182	-1.148
135	17	-178	.037	-.014	-322	135	108	-252	.056	-.059	-.595	135	158	-825	.162	-.408	-1.557
135	18	-165	.056	.002	-484	135	109	-240	.046	-.084	-.495	135	159	-253	.063	-.087	-.565
135	19	-.031	.078	.441	-.432	135	110	-317	.053	-.152	-.611	135	160	-215	.060	.007	-.460
135	20	-185	.053	.049	-.430	135	111	-250	.052	-.096	-.606	135	161	-207	.058	.058	-.495
135	21	-213	.039	-.088	-.400	135	112	-250	.057	-.084	-.542	135	162	-267	.066	-.022	-.701
135	22	-.035	.069	.347	-.295	135	113	-266	.052	-.129	-.535	135	163	-222	.087	-.004	-.865
135	23	-185	.049	.027	-.432	135	114	-326	.060	-.161	-.754	135	164	-273	.156	.033	-1.150
135	24	-298	.042	-.092	-.351	135	115	-314	.079	-.118	-.847	135	165	-506	.276	.009	-1.370
135	25	.008	.060	.330	-.161	135	116	-305	.082	-.101	-.811	135	166	-929	.240	-.082	-2.088
135	26	-.038	.051	.245	-.221	135	117	-302	.087	-.058	-.921	135	167	-228	.106	.103	-.612
135	27	-.151	.044	-.063	-.360	135	118	-369	.088	.121	-1.025	135	168	-160	.113	.220	-.493
135	28	-169	.041	-.025	-.354	135	119	-288	.074	.116	-.762	135	169	-137	.111	.269	-.495
135	29	-174	.037	-.045	-.276	135	120	-289	.114	-.002	-.892	135	170	-185	.106	.203	-.531
135	30	-228	.049	-.095	-.452	135	121	-308	.128	.080	-.961	135	171	-124	.096	.239	-.590
135	31	-246	.054	-.091	-.512	135	122	-418	.168	.044	-1.323	135	172	-132	.107	.222	-.826
135	32	-171	.041	-.002	-.349	135	123	-354	.153	.004	-1.041	135	173	-202	.184	.280	-1.181
135	33	-.186	.050	-.023	-.355	135	124	-333	.129	-.026	-.914	135	174	-577	.273	.329	-1.568
135	34	-181	.044	-.032	-.385	135	125	-237	.118	.098	-.862	135	175	-189	.110	.136	-.702
135	35	-244	.055	-.091	-.460	135	126	-331	.147	.055	-.970	135	176	-112	.112	.304	-.540
135	36	-184	.045	-.043	-.358	135	127	-310	.172	.109	-1.345	135	177	-.082	.129	.415	-.591
135	37	-175	.042	-.027	-.362	135	128	-341	.166	.088	-1.339	135	178	-.072	.119	.425	-.495
135	38	-241	.054	-.063	-.533	135	129	-337	.154	.047	-1.092	135	179	-.086	.121	.468	-.577
135	39	-244	.056	-.050	-.473	135	130	-302	.080	-.060	-.992	135	180	-.099	.110	.364	-.478
135	40	-.131	.050	.134	-.289	135	131	-287	.091	-.056	-.930	135	181	-.131	.126	.328	-.803
135	41	-.095	.056	.142	-.283	135	132	-230	.073	.009	-.797	135	182	-.438	.191	.257	-1.208
135	42	-.105	.056	.124	-.286	135	133	-252	.088	.000	-1.004	135	183	-.184	.062	.014	-.495
135	43	-.197	.070	.025	-.514	135	134	-360	.114	-.022	-1.449	135	184	-.156	.056	.109	-.403
135	44	-.170	.043	-.004	-.307	135	135	-301	.100	-.016	-.914	135	185	-.167	.079	.275	-.519
135	45	-248	.077	.081	-.529	135	136	-283	.091	-.104	-.837	135	186	-.259	.127	.243	-.806
135	46	-.387	.110	.018	-.887	135	137	-281	.094	-.058	-.979	135	187	-.186	.057	-.030	-.481
135	47	-.269	.078	.097	-.525	135	138	-374	.107	-.139	-1.142	135	188	-.151	.052	.090	-.394
135	48	-.210	.043	-.049	-.450	135	139	-170	.054	.058	-.480	135	189	-.145	.057	.078	-.348
135	49	-.191	.046	.036	-.407	135	140	-214	.064	-.009	-.518	135	190	-.158	.058	.065	-.378
135	50	-.030	.047	.196	-.313	135	141	-251	.106	.080	-.848	135	191	-.225	.072	.040	-.507
135	51	-.022	.052	.274	-.229	135	142	-226	.058	-.011	-.560	135	192	-.262	.080	-.016	-.707
135	52	-.277	.117	.864	-.049	135	143	-178	.051	.051	-.418	135	193	-.138	.078	.311	-.418
135	53	-.066	.092	.355	-.509	135	144	-196	.064	.086	-.511	135	194	-.215	.139	.334	-.789
135	54	-.319	.106	.333	-.878	135	145	-209	.067	.013	-.535	135	195	-.167	.058	.016	-.542
135	55	-.258	.077	.152	-.659	135	146	-340	.099	-.068	-.917	135	196	-.135	.037	-.016	-.279
135	56	-.184	.056	.038	-.443	135	147	-232	.035	-.127	-.420	135	197	-.134	.053	.030	-.466

APPENDIX A -- PRESSURE DATA:

C O L U M B I A P L A Z A , D E N V E R

WD	TAP	CPMEAN	CPRMS	CPMAX	CPMIN	WD	TAP	CPMEAN	CPRMS	CPMAX	CPMIN	WD	TAP	CPMEAN	CPRMS	CPMAX	CPMIN
135	198	-.154	.061	.039	-.436	135	314	-.303	.076	-.053	-.595	135	374	-.296	.110	-.009	-1.070
135	199	-.186	.074	.037	-.591	135	315	-.154	.289	.819	-1.143	135	375	-.351	.129	-.105	-1.202
135	200	-.234	.088	.042	-.586	135	316	.115	.155	.626	-.521	135	376	-.365	.121	-.065	-1.052
135	201	-.055	.068	.334	-.278	135	317	.041	.129	.521	-.380	135	377	-.381	.121	-.031	-1.058
135	202	-.117	.067	.185	-.441	135	318	-.078	.103	.347	-.493	135	378	-.352	.104	.022	-.811
135	203	-.289	.064	.014	-.582	135	319	-.332	.079	.156	-.735	135	379	-.318	.102	.066	-.725
135	204	-.124	.079	.160	-.509	135	320	-.164	.368	.642	-1.680	135	380	-.293	.087	.040	-.663
135	205	-.089	.089	.366	-.505	135	321	-.054	.187	.500	-1.303	135	381	-.259	.082	.016	-.567
135	206	-.019	.111	.401	-.593	135	322	-.072	.130	.356	-.870	135	382	-.224	.078	.029	-.614
135	207	.253	.167	.832	-.808	135	323	-.140	.104	.236	-.614	135	383	-.350	.102	-.046	-1.116
135	208	-.244	.064	-.016	-.516	135	324	-.333	.097	.081	-.740	135	384	-.350	.100	-.093	-.982
135	209	-.379	.189	.909	-.394	135	325	-.460	.304	.415	-1.411	135	385	-.185	.083	.142	-.547
135	210	-.273	.112	.318	-.599	135	326	-.235	.212	.298	-1.214	135	386	-.163	.054	.031	-.455
135	211	.156	.136	.607	-.280	135	327	-.170	.118	.203	-.887	135	387	-.348	.104	-.086	-.968
135	212	.282	.163	.807	-.244	135	328	-.187	.078	.156	-.503	135	388	-.341	.097	-.040	-.936
135	213	.340	.179	.876	-.160	135	329	-.274	.076	-.054	-.591	135	389	-.339	.099	.020	-1.042
135	214	.337	.268	.978	-.840	135	330	-.198	.148	.286	-.844	135	390	-.313	.096	.040	-.915
135	215	-.117	.159	.528	-.607	135	331	-.211	.060	-.007	-.511	135	391	-.267	.097	.035	-.846
135	216	.180	.145	.761	-.242	135	332	-.158	.164	.293	-.840	135	392	-.208	.081	.095	-.532
135	217	.236	.131	.779	-.090	135	333	-.090	.087	.263	-.537	135	393	-.184	.086	.164	-.498
135	218	.230	.127	.754	-.081	135	334	-.093	.074	.233	-.379	135	394	-.165	.056	.035	-.391
135	219	-.028	.316	.782	-1.264	135	335	-.125	.064	.222	-.317	135	403	-.302	.090	-.071	-.895
135	220	.021	.148	.551	-.565	135	336	-.204	.063	.021	-.468	135	404	-.283	.079	-.060	-.756
135	221	.251	.156	.856	-.281	135	347	-.622	.150	-.292	-1.491	135	405	-.256	.066	-.075	-.568
135	222	.270	.135	.759	-.092	135	348	-.627	.153	-.249	-1.212	135	406	-.245	.060	-.044	-.580
135	223	.209	.101	.631	-.098	135	349	-.588	.140	-.221	-1.141	135	407	-.233	.059	-.049	-.711
135	224	-.355	.335	.491	-1.442	135	350	-.524	.148	-.170	-1.200	135	408	-.297	.090	-.057	-.828
135	225	-.052	.114	.508	-.461	135	351	-.423	.152	-.098	-1.059	135	409	-.249	.060	-.060	-.536
135	226	.092	.110	.614	-.228	135	352	-.388	.144	-.047	-.989	135	410	-.331	.084	-.087	-.709
135	227	.137	.106	.554	-.171	135	353	-.345	.132	-.005	-.948	135	411	-.292	.071	-.075	-.760
135	228	-.166	.184	.307	-1.095	135	354	-.312	.111	-.005	-.842	135	412	-.282	.066	-.102	-.546
135	229	-.011	.119	.640	-.366	135	355	-.621	.150	-.303	-1.363	135	413	-.282	.060	-.098	-.543
135	230	.125	.116	.688	-.118	135	356	-.621	.134	-.268	-1.168	135	414	-.295	.070	-.104	-.727
135	231	.177	.113	.612	-.086	135	357	-.316	.106	-.108	-.831	135	415	-.301	.096	-.084	-.755
135	232	.178	.099	.586	-.051	135	358	-.298	.090	-.035	-.847	135	416	-.270	.092	.082	-.676
135	233	.156	.073	.531	-.051	135	359	-.576	.145	-.215	-1.405	135	417	-.255	.087	.047	-.672
135	234	-.169	.198	.588	-1.043	135	360	-.600	.132	-.200	-1.259	135	418	-.238	.080	.064	-.609
135	301	-.140	.030	-.023	-.296	135	361	-.575	.145	-.092	-1.234	135	419	-.244	.094	.038	-.742
135	302	-.177	.033	-.047	-.370	135	362	-.529	.150	-.028	-1.184	135	420	-.211	.078	.031	-.585
135	303	-.320	.055	-.107	-.688	135	363	-.405	.129	.012	-.937	135	421	-.184	.069	.020	-.601
135	304	-.667	.289	-.091	-1.657	135	364	-.361	.123	.040	-.838	135	422	-.171	.065	.056	-.469
135	305	-.678	.118	-.303	-1.096	135	365	-.330	.103	-.014	-.892	135	423	-.149	.055	.029	-.356
135	306	-.130	.043	.030	-.342	135	366	-.322	.090	-.056	-.726	135	424	-.174	.095	.183	-.729
135	307	-.062	.047	.124	-.245	135	367	-.567	.173	-.133	-1.323	135	425	-.198	.053	-.029	-.627
135	308	.094	.165	.586	-.696	135	368	-.573	.184	-.161	-1.478	135	426	-.178	.043	-.024	-.324
135	309	-.152	.095	.190	-.580	135	369	-.536	.192	-.045	-1.467	135	427	-.165	.040	-.027	-.307
135	310	-.161	.083	.135	-.568	135	370	-.461	.162	.002	-1.130	135	428	-.182	.071	.033	-.612
135	311	-.217	.071	.065	-.499	135	371	-.338	.131	.054	-.903	135	429	-.183	.045	.002	-.330
135	312	-.336	.070	-.047	-.593	135	372	-.302	.123	.042	-.907	135	430	-.177	.044	.036	-.311
135	313	.217	.180	.706	-.702	135	373	-.292	.117	.162	-.840	135	431	-.165	.041	.011	-.294

APPENDIX A -- PRESSURE DATA:

C O L U M B I A P L A Z A , D E N V E R

WD	TAP	CPMEAN	CPRMS	CPMAX	CPMIN	WD	TAP	CPMEAN	CPRMS	CPMAX	CPMIN	WD	TAP	CPMEAN	CPRMS	CPMAX	CPMIN
135	432	-.162	.045	.027	-.393	150	41	-.066	.065	.223	-.238	150	132	-.258	.086	.042	-.703
135	433	-.175	.044	-.007	-.406	150	42	-.075	.066	.195	-.262	150	133	-.290	.106	.049	-1.034
135	434	-.199	.070	.067	-.527	150	43	-.267	.090	-.018	-.608	150	134	-.420	.132	-.042	-1.101
135	435	-.098	.053	.152	-.256	150	44	-.214	.042	-.065	-.376	150	135	-.376	.118	-.103	-.939
135	436	-.128	.057	.099	-.535	150	45	-.401	.064	-.119	-.641	150	136	-.351	.117	-.086	-1.070
135	437	-.112	.050	.100	-.237	150	46	-.588	.115	-.219	-1.149	150	137	-.369	.127	-.080	-1.116
135	438	-.104	.046	.198	-.240	150	47	-.428	.071	-.158	-.766	150	138	-.459	.150	-.165	-1.182
135	439	-.106	.045	.183	-.272	150	48	-.263	.047	-.127	-.456	150	139	-.191	.066	.007	-.455
135	440	-.107	.047	.088	-.307	150	49	-.248	.042	.045	-.479	150	140	-.263	.076	-.015	-.610
135	441	-.125	.054	.049	-.446	150	50	-.068	.034	.094	-.197	150	141	-.335	.142	-.009	-1.194
150	1	-.119	.056	.097	-.340	150	51	-.062	.050	.153	-.259	150	142	-.240	.069	.002	-.536
150	2	-.135	.050	.031	-.331	150	52	.320	.112	.743	-.053	150	143	-.204	.059	-.016	-.518
150	3	-.153	.048	-.009	-.320	150	53	-.038	.067	.351	-.407	150	144	-.240	.074	.038	-.564
150	4	-.151	.051	.000	-.376	150	54	-.281	.102	.127	-.709	150	145	-.254	.078	.065	-.634
150	5	-.166	.058	.047	-.418	150	55	-.233	.074	.090	-.595	150	146	-.404	.121	-.013	-1.004
150	6	-.180	.051	-.007	-.447	150	56	-.162	.050	-.009	-.367	150	147	-.319	.046	-.193	-.538
150	7	-.223	.082	.011	-.597	150	57	-.150	.069	.061	-.477	150	148	-.268	.039	-.144	-.413
150	8	-.227	.064	-.045	-.498	150	58	-.217	.090	.217	-.586	150	149	-.264	.038	-.136	-.426
150	9	-.295	.083	-.025	-.731	150	59	-.304	.091	-.063	-.718	150	150	-.333	.042	-.179	-.507
150	10	-.304	.077	-.042	-.644	150	101	-.801	.178	-.228	-1.433	150	151	-.275	.044	-.123	-.589
150	11	-.339	.085	-.113	-.714	150	102	-.331	.100	-.082	-.840	150	152	-.315	.059	-.135	-.679
150	12	-.379	.099	-.111	-.779	150	103	-.274	.082	-.081	-.686	150	153	-.425	.121	-.134	-1.047
150	13	-.259	.070	-.049	-.524	150	104	-.269	.079	-.080	-.639	150	154	-.847	.130	-.435	-1.531
150	14	-.249	.062	-.087	-.483	150	105	-.386	.068	-.196	-.741	150	155	-.318	.044	-.208	-.612
150	15	-.189	.055	.005	-.394	150	106	-.848	.131	-.443	-1.524	150	156	-.243	.038	-.108	-.394
150	16	-.170	.048	-.018	-.354	150	107	-1.132	.139	-.702	-1.775	150	157	-.367	.149	-.067	-1.045
150	17	-.161	.052	-.009	-.472	150	108	-.378	.093	.130	-1.019	150	158	-.830	.132	-.311	-1.520
150	18	-.150	.051	-.002	-.512	150	109	-.360	.074	-.123	-.766	150	159	-.349	.084	-.114	-.677
150	19	-.075	.043	.149	-.124	150	110	-.436	.083	-.229	-.911	150	160	-.239	.060	-.024	-.449
150	20	-.220	.036	-.098	-.514	150	111	-.365	.081	-.184	-.872	150	161	-.195	.050	.004	-.359
150	21	-.257	.037	-.108	-.391	150	112	-.362	.080	-.175	-1.156	150	162	-.236	.052	-.015	-.439
150	22	-.086	.033	.083	-.206	150	113	-.381	.085	-.150	-.895	150	163	-.145	.046	.007	-.347
150	23	-.210	.036	-.047	-.394	150	114	-.437	.086	-.216	-1.180	150	164	-.140	.064	.069	-.657
150	24	-.250	.041	-.134	-.421	150	115	-.516	.146	-.159	-1.217	150	165	-.240	.179	.152	-.982
150	25	-.071	.034	.081	-.214	150	116	-.493	.137	-.126	-1.145	150	166	-.725	.183	-.128	-1.489
150	26	-.105	.032	.067	-.230	150	117	-.470	.139	-.114	-1.297	150	167	-.283	.118	.090	-.731
150	27	-.181	.033	.056	-.324	150	118	-.528	.134	-.212	-1.140	150	168	-.165	.105	.287	-.491
150	28	-.197	.036	-.078	-.327	150	119	-.429	.114	-.173	-.897	150	169	-.124	.103	.313	-.404
150	29	-.215	.032	-.112	-.360	150	120	-.406	.176	.053	-1.368	150	170	-.166	.092	.227	-.404
150	30	-.280	.053	-.127	-.528	150	121	-.457	.211	.069	-1.377	150	171	-.102	.070	.191	-.307
150	31	-.314	.057	-.149	-.556	150	122	-.597	.253	.110	-1.932	150	172	-.101	.066	.201	-.301
150	32	-.197	.043	-.056	-.380	150	123	-.506	.202	.052	-1.452	150	173	-.119	.105	.201	-.891
150	33	-.240	.064	-.031	-.479	150	124	-.460	.170	-.071	-1.298	150	174	-.591	.184	-.007	-1.301
150	34	-.212	.053	.009	-.474	150	125	-.285	.153	.172	-1.199	150	175	-.233	.129	.146	-.728
150	35	-.305	.070	-.133	-.588	150	126	-.412	.209	.165	-1.467	150	176	-.103	.113	.378	-.531
150	36	-.232	.056	-.058	-.463	150	127	-.427	.245	.217	-1.526	150	177	-.050	.113	.413	-.496
150	37	-.195	.050	-.018	-.429	150	128	-.479	.223	.080	-1.605	150	178	-.032	.100	.426	-.335
150	38	-.312	.060	-.143	-.550	150	129	-.458	.192	.002	-1.234	150	179	-.055	.095	.374	-.365
150	39	-.313	.056	-.155	-.536	150	130	-.331	.096	-.026	-.823	150	180	-.075	.081	.260	-.304
150	40	-.147	.052	.022	-.352	150	131	-.361	.129	-.092	-1.112	150	181	-.108	.087	.277	-.517

WD	TAP	CPMEAN	CPRMS	CPMAX	CPMIN	WD	TAP	CPMEAN	CPRMS	CPMAX	CPMIN	WD	TAP	CPMEAN	CPRMS	CPMAX	CPMIN
150	182	-.470	.147	.070	-1.058	150	232	.251	.101	.686	-.035	150	358	.000	.000	.000	.000
150	183	-.222	.071	.012	-.537	150	233	.153	.074	.457	-.032	150	359	.000	.000	.000	.000
150	184	-.146	.061	.125	-.445	150	234	-.308	.203	.339	-.958	150	360	.000	.000	.000	.000
150	185	-.131	.067	.111	-.434	150	301	-.203	.056	-.014	-.506	150	361	.000	.000	.000	.000
150	186	-.231	.103	.116	-.619	150	302	-.193	.061	.005	-.560	150	362	.000	.000	.000	.000
150	187	-.220	.064	-.016	-.493	150	303	-.312	.182	-.166	-1.211	150	363	.000	.000	.000	.000
150	188	-.148	.054	.079	-.355	150	304	-.966	.202	-.172	-1.579	150	364	.000	.000	.000	.000
150	189	-.128	.057	.125	-.388	150	305	-.510	.085	-.189	-.869	150	365	-.428	.067	-.210	-.711
150	190	-.132	.058	.116	-.354	150	306	-.173	.041	-.014	-.305	150	366	-.456	.092	-.201	-.903
150	191	-.196	.071	.056	-.523	150	307	-.154	.066	.031	-.431	150	367	-.363	.072	-.166	-.820
150	192	-.236	.078	-.019	-.635	150	308	-.419	.219	.297	-1.360	150	368	-.380	.076	-.203	-.850
150	193	-.116	.067	.136	-.383	150	309	-.322	.075	-.007	-.601	150	369	-.401	.075	-.167	-.900
150	194	-.205	.114	.240	-.615	150	310	-.270	.066	-.031	-.490	150	370	-.409	.076	-.201	-.868
150	195	-.199	.062	-.018	-.533	150	311	-.268	.055	-.073	-.481	150	371	-.429	.081	-.107	-.834
150	196	-.142	.034	-.037	-.302	150	312	-.308	.048	-.157	-.491	150	372	-.443	.086	.002	-.815
150	197	-.125	.045	.056	-.338	150	313	-.385	.250	.346	-1.241	150	373	-.465	.093	-.160	-.897
150	198	-.140	.055	.048	-.365	150	314	-.266	.042	-.121	-.442	150	374	-.520	.137	-.123	-1.211
150	199	-.170	.074	.075	-.501	150	315	-.519	.325	.479	-1.514	150	375	-.442	.093	-.130	-.872
150	200	-.218	.092	.126	-.609	150	316	-.142	.133	.243	-.907	150	376	-.450	.093	-.212	-.841
150	201	-.044	.058	.192	-.220	150	317	-.123	.076	.246	-.339	150	377	-.475	.088	-.263	-.912
150	202	-.104	.064	.148	-.379	150	318	-.175	.059	.137	-.350	150	378	-.482	.090	-.278	-.974
150	203	-.164	.075	.184	-.547	150	319	-.283	.041	-.100	-.417	150	379	-.508	.103	-.223	-1.038
150	204	-.023	.099	.323	-.381	150	320	-.727	.338	.392	-1.823	150	380	-.489	.089	-.223	-.943
150	205	.007	.103	.345	-.401	150	321	-.299	.211	.248	-1.270	150	381	-.428	.081	-.057	-.762
150	206	.095	.120	.501	-.344	150	322	-.205	.081	.156	-.811	150	382	-.374	.102	-.110	-.914
150	207	.118	.171	.634	-.780	150	323	-.219	.057	.062	-.427	150	383	-.472	.085	-.245	-.832
150	208	-.088	.082	.200	-.372	150	324	-.278	.046	-.118	-.453	150	384	-.487	.089	-.276	-.912
150	209	.180	.198	.767	-.600	150	325	-.796	.278	.122	-1.644	150	385	-.248	.114	.106	-.651
150	210	-.090	.106	.307	-.540	150	326	-.418	.241	.050	-1.511	150	386	-.214	.059	.002	-.421
150	211	.349	.132	.755	-.026	150	327	-.278	.118	-.017	-1.171	150	387	-.475	.090	-.263	-.894
150	212	.470	.146	.907	.044	150	328	-.274	.062	-.061	-.770	150	388	-.491	.090	-.283	-.934
150	213	.505	.150	.980	.049	150	329	-.363	.060	-.189	-.609	150	389	-.499	.094	-.263	-1.078
150	214	-.021	.300	.734	-1.115	150	330	-.358	.150	.180	-.993	150	390	-.495	.104	-.242	-1.119
150	215	-.021	.114	.559	-.375	150	331	-.335	.059	-.161	-.592	150	391	-.418	.105	-.009	-.885
150	216	.355	.138	.884	-.047	150	332	-.321	.176	.212	-.985	150	392	-.262	.113	.128	-.605
150	217	.448	.143	.992	.053	150	333	-.181	.074	.169	-.480	150	393	-.246	.116	.150	-.651
150	218	.434	.144	.900	.055	150	334	-.185	.058	.069	-.395	150	394	-.220	.068	.018	-.546
150	219	-.385	.351	.643	-1.992	150	335	-.229	.051	-.036	-.431	150	403	-.320	.070	-.101	-.621
150	220	.043	.109	.486	-.286	150	336	-.326	.062	-.151	-.588	150	404	-.306	.065	-.101	-.605
150	221	.307	.128	.915	-.021	150	347	-.397	.058	-.230	-.702	150	405	-.308	.060	-.055	-.532
150	222	.349	.130	.921	.053	150	348	-.387	.058	-.227	-.727	150	406	-.307	.060	-.040	-.508
150	223	.295	.119	.780	.007	150	349	.000	.000	.000	.000	150	407	-.328	.072	-.119	-.760
150	224	-.508	.291	.465	-1.610	150	350	.000	.000	.000	.000	150	408	-.328	.068	-.064	-.618
150	225	-.009	.084	.357	-.306	150	351	.000	.000	.000	.000	150	409	-.363	.079	-.137	-.766
150	226	.134	.090	.496	-.106	150	352	.000	.000	.000	.000	150	410	-.413	.066	-.234	-.724
150	227	.175	.092	.531	-.068	150	353	.000	.000	.000	.000	150	411	-.370	.057	-.185	-.683
150	228	-.309	.193	.414	-1.100	150	354	.000	.000	.000	.000	150	412	-.360	.058	-.175	-.633
150	229	.013	.087	.392	-.241	150	355	.000	.000	.000	.000	150	413	-.369	.069	-.181	-.760
150	230	.162	.091	.575	-.078	150	356	.000	.000	.000	.000	150	414	-.457	.125	-.181	-1.091
150	231	.227	.099	.636	-.044	150	357	.000	.000	.000	.000	150	415	-.420	.088	-.137	-.824

APPENDIX A -- PRESSURE DATA:

C O L U M B I A P L A Z A , D E N V E R

WD	TAP	CPMEAN	CPRMS	CPMAX	CPMIN	WD	TAP	CPMEAN	CPRMS	CPMAX	CPMIN	WD	TAP	CPMEAN	CPRMS	CPMAX	CPMIN
150	416	-.349	.080	-.105	-.854	165	25	-.096	.030	.061	-.198	165	116	-.457	.115	-.060	-1.258
150	417	-.319	.069	-.046	-.596	165	26	-.141	.029	.000	-.246	165	117	-.451	.104	-.160	-.976
150	418	-.294	.073	-.046	-.674	165	27	-.230	.030	-.108	-.344	165	118	-.517	.097	-.298	-1.015
150	419	-.333	.122	-.007	-1.075	165	28	-.233	.030	-.100	-.359	165	119	-.421	.082	-.183	-.847
150	420	-.288	.086	.118	-.716	165	29	-.251	.030	-.149	-.351	165	120	-.482	.168	-.089	-1.232
150	421	-.234	.074	.013	-.563	165	30	-.336	.051	-.184	-.508	165	121	-.498	.170	.027	-1.331
150	422	-.207	.070	.152	-.590	165	31	-.369	.056	-.212	-.628	165	122	-.620	.185	-.122	-1.461
150	423	-.183	.058	.029	-.414	165	32	-.274	.044	-.133	-.453	165	123	-.532	.157	-.158	-1.276
150	424	-.217	.099	.077	-.732	165	33	-.322	.049	-.146	-.502	165	124	-.505	.137	-.194	-1.102
150	425	-.252	.066	-.038	-.574	165	34	-.282	.046	-.092	-.479	165	125	-.407	.148	.004	-1.131
150	426	-.229	.060	-.004	-.492	165	35	-.361	.055	-.218	-.612	165	126	-.534	.167	.053	-1.356
150	427	-.213	.052	-.009	-.458	165	36	-.298	.052	-.155	-.513	165	127	-.536	.174	-.005	-1.299
150	428	-.199	.078	.088	-.793	165	37	-.239	.039	-.056	-.428	165	128	-.556	.156	-.100	-1.356
150	429	-.243	.062	.024	-.541	165	38	-.373	.060	-.215	-.600	165	129	-.546	.152	-.103	-1.297
150	430	-.234	.061	-.013	-.495	165	39	-.380	.061	-.225	-.628	165	130	-.399	.084	-.134	-.737
150	431	-.218	.052	-.046	-.427	165	40	-.244	.049	-.024	-.435	165	131	-.585	.137	-.264	-1.200
150	432	-.208	.054	.000	-.432	165	41	-.161	.052	.097	-.349	165	132	-.314	.078	-.107	-.641
150	433	-.201	.051	-.031	-.444	165	42	-.180	.052	.043	-.474	165	133	-.329	.085	.031	-.701
150	434	-.202	.073	.029	-.621	165	43	-.399	.066	-.162	-.659	165	134	-.486	.119	-.189	-1.091
150	435	-.087	.062	.130	-.253	165	44	-.293	.042	-.142	-.453	165	135	-.519	.134	-.160	-1.245
150	436	-.129	.060	.105	-.434	165	45	-.425	.051	-.248	-.639	165	136	-.561	.144	-.216	-1.249
150	437	-.109	.053	.128	-.256	165	46	-.500	.080	-.311	-.893	165	137	-.497	.128	-.151	-1.165
150	438	-.106	.048	.291	-.247	165	47	-.409	.053	-.288	-.657	165	138	-.659	.147	-.296	-1.394
150	439	-.111	.043	.119	-.227	165	48	-.320	.045	-.191	-.544	165	139	-.259	.068	-.077	-.533
150	440	-.113	.046	.088	-.294	165	49	-.309	.036	-.011	-.461	165	140	-.342	.062	-.125	-.617
150	441	-.127	.057	.055	-.409	165	50	-.111	.031	.002	-.237	165	141	-.557	.153	-.175	-1.223
165	1	-.114	.040	.043	-.302	165	51	-.143	.050	.029	-.389	165	142	-.325	.077	-.098	-.588
165	2	-.126	.039	.009	-.291	165	52	-.250	.119	.761	-.104	165	143	-.262	.045	-.133	-.438
165	3	-.130	.040	-.005	-.304	165	53	-.039	.062	.221	-.313	165	144	-.315	.063	-.116	-.577
165	4	-.119	.041	.051	-.275	165	54	-.212	.083	.083	-.577	165	145	-.352	.066	-.155	-.600
165	5	-.145	.046	.023	-.356	165	55	-.189	.059	.023	-.398	165	146	-.558	.123	-.267	-1.113
165	6	-.156	.042	-.016	-.354	165	56	-.141	.046	-.002	-.344	165	147	-.330	.031	-.237	-.504
165	7	-.174	.065	.020	-.506	165	57	-.120	.052	.115	-.349	165	148	-.222	.048	-.031	-.412
165	8	-.175	.052	-.038	-.388	165	58	-.154	.073	.139	-.450	165	149	-.203	.054	.047	-.441
165	9	-.228	.073	-.003	-.376	165	59	-.236	.078	.023	-.356	165	150	-.264	.061	.011	-.528
165	10	-.236	.066	-.069	-.346	165	101	-.926	.147	-.477	-1.434	165	151	-.176	.055	.042	-.392
165	11	-.256	.072	-.070	-.360	165	102	-.584	.196	-.118	-1.318	165	152	-.209	.065	.029	-.463
165	12	-.280	.084	-.078	-.610	165	103	-.471	.116	-.081	-.845	165	153	-.201	.066	.007	-.483
165	13	-.203	.056	-.029	-.434	165	104	-.421	.084	-.094	-.851	165	154	-.588	.161	-.111	-1.084
165	14	-.198	.048	-.043	-.407	165	105	-.507	.098	-.227	-1.198	165	155	-.295	.012	-.262	-.337
165	15	-.158	.045	.014	-.342	165	106	-.876	.127	-.523	-1.563	165	156	-.149	.051	.049	-.343
165	16	-.147	.041	.004	-.320	165	107	-1.057	.128	-.637	-1.464	165	157	-.078	.079	.189	-.434
165	17	-.139	.043	.000	-.385	165	108	-.408	.075	-.171	-.891	165	158	-.482	.181	.085	-1.176
165	18	-.138	.044	.051	-.474	165	109	-.412	.074	-.227	-.884	165	159	-.299	.058	-.131	-.576
165	19	-.102	.028	.025	-.216	165	110	-.502	.081	-.310	-1.006	165	160	-.145	.051	.098	-.345
165	20	-.271	.033	-.149	-.391	165	111	-.434	.076	-.251	-.910	165	161	-.094	.051	.117	-.272
165	21	-.306	.035	-.194	-.441	165	112	-.436	.073	-.234	-1.022	165	162	-.119	.058	.120	-.310
165	22	-.119	.031	-.004	-.244	165	113	-.419	.083	-.214	-1.030	165	163	-.021	.059	.167	-.210
165	23	-.261	.033	-.146	-.380	165	114	-.593	.082	-.298	-1.394	165	164	-.007	.065	.223	-.227
165	24	-.290	.037	-.164	-.475	165	115	-.484	.139	-.167	-1.279	165	165	-.003	.096	.321	-.517

APPENDIX A -- PRESSURE DATA:

C O L U M B I A P L A Z A , D E N V E R

WD	TAP	CPMEAN	CPRMS	CPMAX	CPMIN	WD	TAP	CPMEAN	CPRMS	CPMAX	CPMIN	WD	TAP	CPMEAN	CPRMS	CPMAX	CPMIN
165	166	-.441	.163	.145	-1.093	165	216	.373	.139	.856	-.102	165	332	-.442	.143	-.035	-.935
165	167	-.290	.083	-.045	-.709	165	217	.456	.150	1.008	-.062	165	333	-.243	.059	-.052	-.448
165	168	-.142	.071	.156	-.425	165	218	.419	.138	.968	-.101	165	334	-.234	.049	-.052	-.416
165	169	-.094	.069	.202	-.324	165	219	-.786	.301	.232	-1.921	165	335	-.252	.048	-.090	-.430
165	170	-.130	.063	.149	-.341	165	220	.041	.098	.452	-.288	165	336	-.300	.060	-.118	-.525
165	171	-.060	.055	.165	-.228	165	221	.309	.131	.821	-.148	165	347	-.360	.052	-.196	-.578
165	172	-.061	.055	.147	-.241	165	222	.366	.136	.861	-.106	165	348	-.362	.055	-.177	-.584
165	173	-.076	.076	.169	-.560	165	223	.310	.124	.787	-.190	165	349	-.373	.055	-.193	-.583
165	174	-.535	.138	-.125	-1.158	165	224	-.716	.244	.058	-1.742	165	350	-.372	.056	-.146	-.647
165	175	-.259	.091	.016	-.662	165	225	-.016	.070	.311	-.263	165	351	-.373	.061	-.156	-.772
165	176	-.138	.075	.216	-.381	165	226	.195	.083	.514	-.147	165	352	-.388	.073	-.153	-.808
165	177	-.082	.067	.383	-.271	165	227	.142	.090	.548	-.084	165	353	-.392	.088	-.107	-1.048
165	178	-.058	.057	.281	-.223	165	228	-.420	.163	.095	-1.112	165	354	-.389	.084	-.135	-.888
165	179	-.053	.053	.233	-.219	165	229	.012	.074	.353	-.189	165	355	-.348	.046	-.153	-.522
165	180	-.060	.050	.129	-.247	165	230	.135	.091	.539	-.057	165	356	-.351	.049	-.130	-.535
165	181	-.081	.066	.112	-.500	165	231	.194	.105	.710	-.046	165	357	-.384	.076	-.117	-.938
165	182	-.427	.144	.012	-1.153	165	232	.211	.109	.646	-.044	165	358	-.383	.075	-.083	-.727
165	183	-.281	.069	-.012	-.572	165	233	.111	.082	.475	-.122	165	359	-.354	.048	-.231	-.552
165	184	-.134	.054	.081	-.369	165	234	-.431	.167	.046	-1.046	165	360	-.360	.050	-.212	-.542
165	185	-.191	.053	.172	-.305	165	301	-.379	.122	-.071	-.824	165	361	-.381	.048	-.245	-.729
165	186	-.163	.077	.097	-.483	165	302	-.363	.151	-.002	-1.011	165	362	-.380	.048	-.248	-.671
165	187	-.278	.063	-.042	-.598	165	303	-.810	.168	-.274	-1.371	165	363	-.379	.046	-.250	-.545
165	188	-.137	.053	.122	-.334	165	304	-1.053	.144	-.499	-1.592	165	364	-.394	.050	-.243	-.589
165	189	-.105	.052	.184	-.275	165	305	-.378	.095	-.119	-.707	165	365	-.402	.049	-.248	-.574
165	190	-.101	.048	.107	-.260	165	306	-.202	.055	.002	-.444	165	366	-.421	.063	-.229	-.659
165	191	-.139	.054	.035	-.381	165	307	-.336	.094	-.019	-.769	165	367	-.347	.054	-.186	-.592
165	192	-.174	.064	.032	-.494	165	308	-1.040	.246	-.268	-2.153	165	368	-.358	.056	-.186	-.605
165	193	-.079	.057	.129	-.264	165	309	-.574	.178	-.255	-1.286	165	369	-.371	.050	-.217	-.574
165	194	-.146	.086	.174	-.452	165	310	-.401	.069	-.222	-.850	165	370	-.374	.048	-.205	-.586
165	195	-.265	.057	-.069	-.496	165	311	-.330	.047	-.196	-.503	165	371	-.382	.052	-.210	-.628
165	196	-.147	.033	.053	-.256	165	312	-.310	.043	-.167	-.483	165	372	-.394	.057	-.155	-.657
165	197	-.117	.038	.030	-.284	165	313	-1.166	.263	-.312	-1.990	165	373	-.416	.061	-.202	-.707
165	198	-.117	.040	.021	-.303	165	314	-.306	.041	-.179	-.531	165	374	-.437	.087	-.120	-.966
165	199	-.134	.050	.023	-.367	165	315	-1.111	.265	-.349	-2.434	165	375	-.356	.075	-.111	-.793
165	200	-.155	.065	.032	-.415	165	316	-.673	.300	-.101	-1.639	165	376	-.369	.075	-.101	-.827
165	201	-.089	.041	.111	-.231	165	317	-.394	.157	-.155	-1.286	165	377	-.384	.066	-.198	-.654
165	202	-.087	.045	.080	-.266	165	318	-.323	.066	-.158	-.907	165	378	-.403	.065	-.223	-.653
165	203	.052	.110	.427	-.283	165	319	-.328	.041	-.205	-.585	165	379	-.443	.072	-.219	-.830
165	204	.118	.112	.503	-.217	165	320	-1.175	.296	-.332	-2.423	165	380	-.430	.065	-.179	-.690
165	205	.088	.119	.519	-.305	165	321	-.620	.284	-.081	-1.645	165	381	-.412	.072	-.155	-.694
165	206	.125	.131	.599	-.310	165	322	-.371	.136	-.154	-1.240	165	382	-.437	.119	-.042	-1.059
165	207	-.388	.221	.278	-1.306	165	323	-.303	.061	-.170	-.779	165	383	-.405	.074	-.159	-.645
165	208	.170	.121	.618	-.231	165	324	-.298	.045	-.167	-.502	165	384	-.401	.073	-.216	-.756
165	209	-.455	.250	.251	-1.375	165	325	-1.062	.253	-.307	-2.271	165	385	-.349	.071	-.068	-.739
165	210	.119	.115	.530	-.257	165	326	-.643	.249	-.158	-1.663	165	386	-.338	.095	-.073	-1.039
165	211	.459	.146	.940	.079	165	327	-.400	.151	-.146	-1.230	165	387	-.388	.074	-.161	-.715
165	212	.531	.151	1.901	.111	165	328	-.323	.076	-.148	-.815	165	388	-.410	.080	-.205	-.754
165	213	.490	.140	.907	.028	165	329	-.319	.060	-.152	-.700	165	389	-.414	.081	-.198	-.792
165	214	-.750	.292	.298	-1.852	165	330	-.465	.122	-.139	-.940	165	390	-.424	.087	-.218	-.911
165	215	.016	.086	.350	-.260	165	331	-.304	.055	-.139	-.479	165	391	-.405	.087	-.113	-.742

APPENDIX A -- PRESSURE DATA:

C O L U M B I A P L A Z A , D E N V E R

WD	TAP	CPMEAN	CPRMS	CPMAX	CPMIN	WD	TAP	CPMEAN	CPRMS	CPMAX	CPMIN	WD	TAP	CPMEAN	CPRMS	CPMAX	CPMIN
165	392	-.367	.073	-.060	-.650	180	9	-.130	.050	.110	-.393	180	39	-.123	.060	.340	-.349
165	393	-.362	.074	-.164	-.700	180	10	-.126	.055	.147	-.379	180	101	-.890	.138	-.303	-1.335
165	394	-.346	.089	-.044	-.779	180	11	-.134	.051	.083	-.376	180	102	-.616	.201	-.100	-1.237
165	403	-.375	.060	-.113	-.605	180	12	-.149	.057	.059	-.394	180	103	-.508	.119	-.169	-.907
165	404	-.375	.056	-.166	-.600	180	13	-.122	.047	.170	-.419	180	104	-.399	.106	-.095	-.923
165	405	-.358	.051	-.148	-.661	180	14	-.116	.047	.156	-.322	180	105	-.640	.129	-.316	-1.256
165	406	-.356	.056	-.168	-.663	180	15	-.106	.043	.178	-.317	180	106	-.949	.181	-.404	-1.657
165	407	-.394	.076	-.199	-.878	180	16	-.118	.048	.163	-.403	180	107	-.927	.163	-.482	-1.620
165	408	-.370	.055	-.179	-.675	180	17	-.126	.055	.085	-.341	180	108	-.386	.075	-.124	-.702
165	409	-.397	.052	-.229	-.666	180	18	-.110	.040	.082	-.265	180	109	-.425	.111	-.126	-.965
165	410	-.366	.044	-.192	-.513	180	19	-.120	.029	-.020	-.241	180	110	-.616	.161	-.231	-1.315
165	411	-.367	.046	-.192	-.527	180	20	-.234	.029	-.134	-.344	180	111	-.721	.190	-.209	-1.402
165	412	.000	.000	.000	.000	180	21	-.111	.030	-.013	-.227	180	112	-1.050	.245	-.342	-1.877
165	413	-.379	.054	-.187	-.633	180	22	-.206	.031	-.100	-.331	180	113	-.400	.070	-.182	-.761
165	414	-.466	.128	-.105	-1.117	180	23	-.215	.032	-.115	-.358	180	114	-1.186	.241	-.435	-2.226
165	415	-.390	.064	-.168	-.664	180	24	-.203	.031	-.093	-.319	180	115	-.379	.088	-.034	-1.078
165	416	-.377	.065	-.033	-.675	180	25	-.116	.032	.043	-.229	180	116	-.395	.125	-.027	-1.102
165	417	-.370	.065	-.161	-.699	180	26	-.079	.032	.120	-.170	180	117	-.508	.189	-.081	-1.268
165	418	-.367	.078	-.089	-.733	180	27	-.193	.036	-.047	-.315	180	118	-.839	.260	-.169	-1.757
165	419	-.436	.133	-.068	-1.092	180	28	-.197	.029	-.075	-.301	180	119	-.891	.215	-.203	-1.665
165	420	-.382	.098	-.004	-.850	180	29	-.195	.036	-.063	-.370	180	120	-.340	.075	-.055	-.811
165	421	-.343	.098	.073	-.738	180	30	-.169	.033	.005	-.292	180	121	-.372	.101	-.058	-1.066
165	422	-.336	.099	-.050	-.711	180	31	-.203	.035	-.097	-.385	180	122	-.527	.157	-.160	-1.533
165	423	-.339	.088	-.062	-.686	180	32	-.234	.051	-.052	-.544	180	123	-.570	.201	-.083	-1.652
165	424	-.355	.099	-.060	-.848	180	33	-.258	.045	-.043	-.493	180	124	-.724	.196	-.168	-1.422
165	425	-.350	.100	.053	-.869	180	34	-.246	.045	-.079	-.449	180	125	-.341	.065	-.175	-.693
165	426	-.340	.097	.159	-.855	180	35	-.187	.036	-.061	-.353	180	126	-.423	.079	-.173	-.860
165	427	-.360	.098	.102	-.958	180	36	-.214	.036	-.088	-.351	180	127	-.404	.101	-.133	-.974
165	428	-.346	.069	-.097	-.711	180	37	-.194	.042	-.045	-.327	180	128	-.483	.120	-.170	-1.071
165	429	-.342	.101	-.044	-.977	180	38	-.242	.046	-.073	-.415	180	129	-.548	.138	-.184	-1.220
165	430	-.333	.102	.052	-.824	180	39	-.195	.040	-.072	-.315	180	130	-.393	.062	-.207	-.944
165	431	-.348	.104	-.055	-.746	180	40	-.208	.037	-.077	-.326	180	131	-.489	.113	-.200	-1.130
165	432	-.367	.096	-.049	-.766	180	41	-.228	.047	-.038	-.417	180	132	-.306	.057	-.130	-.696
165	433	-.354	.080	-.119	-.765	180	42	-.229	.041	-.045	-.413	180	133	-.286	.042	-.141	-.577
165	434	-.329	.081	-.094	-.718	180	43	-.286	.055	-.115	-.669	180	134	-.377	.057	-.187	-.949
165	435	-.317	.106	.022	-.929	180	44	-.232	.048	.020	-.657	180	135	-.372	.086	-.113	-.896
165	436	-.332	.098	-.057	-.748	180	45	-.291	.069	-.101	-.673	180	136	-.492	.111	-.210	-1.040
165	437	-.318	.096	-.051	-.697	180	46	-.266	.061	-.070	-.628	180	137	-.347	.075	-.144	-.832
165	438	-.323	.104	-.037	-.831	180	47	-.263	.054	-.061	-.515	180	138	-.543	.092	-.278	-1.026
165	439	-.342	.097	-.064	-.680	180	48	-.205	.035	-.054	-.387	180	139	-.298	.057	-.144	-.785
165	440	-.331	.085	-.084	-.581	180	49	-.149	.039	-.025	-.330	180	140	-.287	.048	-.128	-.464
165	441	-.315	.086	-.060	-.633	180	50	-.252	.041	-.097	-.415	180	141	-.424	.103	-.085	-.897
180	1	-.103	.035	.105	-.220	180	51	-.180	.050	-.016	-.414	180	142	-.379	.062	-.147	-.724
180	2	-.100	.041	.111	-.213	180	52	-.046	.116	.444	-.324	180	143	-.271	.039	-.079	-.434
180	3	-.103	.034	.104	-.196	180	53	-.126	.061	.384	-.341	180	144	-.278	.049	-.044	-.475
180	4	-.122	.036	.054	-.270	180	54	-.080	.063	.193	-.358	180	145	-.305	.053	-.013	-.534
180	5	-.114	.040	.092	-.359	180	55	-.109	.057	.320	-.365	180	146	-.490	.081	-.096	-.811
180	6	-.100	.042	.086	-.279	180	56	-.104	.054	.186	-.319	180	147	-.421	.075	-.158	-.716
180	7	-.102	.048	.097	-.324	180	57	-.101	.047	.332	-.276	180	148	-.119	.080	.183	-.384
180	8	-.118	.044	.077	-.444	180	58	-.093	.042	.281	-.313	180	149	-.081	.091	.280	-.399

APPENDIX A -- PRESSURE DATA:

C O L U M B I A P L A Z A , D E N V E R

WD	TAP	CPMEAN	CPRMS	CPMAX	CPMIN	WD	TAP	CPMEAN	CPRMS	CPMAX	CPMIN	WD	TAP	CPMEAN	CPRMS	CPMAX	CPMIN
180	150	-.117	.101	.295	-.504	180	200	-.089	.050	.116	-.298	180	316	-.746	.285	-.205	-1.729
180	151	-.027	.083	.305	-.438	180	201	-.120	.041	.126	-.241	180	317	-.468	.178	-.202	-1.422
180	152	-.031	.100	.362	-.400	180	202	-.088	.040	.165	-.218	180	318	-.346	.101	-.113	-1.197
180	153	-.006	.108	.453	-.413	180	203	.239	.146	.644	-.364	180	319	-.282	.051	-.163	-.741
180	154	-.103	.199	.478	-.900	180	204	.215	.132	.605	-.494	180	320	-.774	.347	-.009	-2.128
180	155	-.416	.076	-.108	-.677	180	205	.182	.119	.619	-.275	180	321	-.386	.106	-.131	-1.198
180	156	-.031	.094	.369	-.373	180	206	.155	.118	.612	-.286	180	322	-.311	.065	-.120	-.627
180	157	.170	.127	.599	-.310	180	207	-.754	.203	-.174	-1.788	180	323	-.274	.052	-.078	-.536
180	158	.048	.223	.724	-.766	180	208	.410	.158	.987	-.309	180	324	-.260	.045	-.111	-.495
180	159	-.432	.114	.047	-.828	180	209	-.900	.235	-.007	-2.193	180	325	-.810	.280	-.098	-1.938
180	160	-.070	.138	.523	-.428	180	210	.096	.118	.639	-.261	180	326	-.379	.122	-.108	-1.195
180	161	-.005	.129	.561	-.337	180	211	.271	.164	.850	-.211	180	327	-.278	.062	-.109	-.826
180	162	-.024	.133	.547	-.404	180	212	.342	.188	.882	-.277	180	328	-.249	.048	-.052	-.517
180	163	.052	.097	.475	-.268	180	213	.347	.191	.917	-.401	180	329	-.229	.042	-.052	-.481
180	164	.047	.090	.470	-.243	180	214	-.845	.307	.326	-1.970	180	330	-.326	.079	-.075	-.773
180	165	.021	.100	.404	-.644	180	215	-.094	.110	.325	-.447	180	331	-.199	.043	-.087	-.406
180	166	-.320	.216	.360	-1.211	180	216	.004	.147	.569	-.455	180	332	-.296	.100	.009	-.828
180	167	-.385	.126	.189	-.920	180	217	.055	.181	.722	-.555	180	333	-.219	.046	-.060	-.436
180	168	-.208	.117	.495	-.599	180	218	.064	.229	.947	-.614	180	334	-.203	.040	-.052	-.368
180	169	-.150	.107	.514	-.644	180	219	-.421	.256	.479	-1.435	180	335	-.197	.036	-.076	-.342
180	170	-.185	.089	.315	-.631	180	220	-.030	.087	.353	-.314	180	336	-.203	.040	-.071	-.375
180	171	-.086	.071	.254	-.367	180	221	.061	.133	.706	-.490	180	347	-.337	.082	-.137	-.720
180	172	-.083	.079	.245	-.415	180	222	.105	.163	.852	-.487	180	348	-.308	.071	-.101	-.677
180	173	-.145	.125	.262	-.776	180	223	.115	.189	.800	-.541	180	349	-.309	.071	-.069	-.724
180	174	-.350	.193	.162	-1.018	180	224	-.392	.242	.414	-1.560	180	350	-.304	.070	-.054	-.962
180	175	-.307	.083	.018	-.801	180	225	-.064	.069	.364	-.348	180	351	-.290	.059	-.139	-.781
180	176	-.177	.083	.267	-.638	180	226	-.016	.072	.292	-.263	180	352	-.292	.056	-.146	-.665
180	177	-.140	.091	.358	-.705	180	227	.001	.083	.332	-.296	180	353	-.308	.057	-.131	-.648
180	178	-.102	.078	.309	-.619	180	228	-.317	.104	-.030	-.826	180	354	-.308	.052	-.158	-.603
180	179	-.063	.069	.216	-.416	180	229	-.048	.066	.369	-.245	180	355	-.335	.078	-.123	-.795
180	180	-.070	.070	.218	-.516	180	230	-.001	.077	.544	-.220	180	356	-.308	.063	-.116	-.734
180	181	-.079	.079	.232	-.505	180	231	.019	.091	.633	-.227	180	357	-.304	.050	-.152	-.595
180	182	-.203	.138	.257	-.839	180	232	.022	.106	.587	-.321	180	358	-.307	.048	-.141	-.594
180	183	-.230	.056	-.002	-.432	180	233	-.024	.089	.477	-.321	180	359	-.288	.045	-.158	-.668
180	184	-.141	.061	.195	-.520	180	234	-.284	.099	.066	-.626	180	360	-.288	.041	-.153	-.538
180	185	-.094	.053	.197	-.333	180	301	-.440	.114	-.095	-.879	180	361	-.306	.041	-.164	-.495
180	186	-.117	.072	.305	-.387	180	302	-.404	.167	.000	-1.077	180	362	-.304	.041	-.174	-.507
180	187	-.236	.056	-.025	-.462	180	303	-.793	.168	-.215	-1.385	180	363	-.299	.037	-.189	-.517
180	188	-.142	.056	.094	-.399	180	304	-.965	.162	-.429	-1.620	180	364	-.304	.039	-.196	-.495
180	189	-.111	.052	.152	-.435	180	305	-.272	.109	.026	-.926	180	365	-.307	.032	-.181	-.462
180	190	-.097	.044	.160	-.362	180	306	-.190	.084	.075	-.592	180	366	-.302	.036	-.170	-.507
180	191	-.096	.045	.102	-.378	180	307	-.329	.100	.012	-.781	180	367	-.279	.053	-.127	-.566
180	192	-.118	.046	.110	-.282	180	308	-1.013	.199	-.509	-1.963	180	368	-.288	.061	-.130	-.639
180	193	-.080	.049	.315	-.315	180	309	-.867	.189	-.319	-1.493	180	369	-.307	.066	-.110	-.864
180	194	-.103	.064	.348	-.303	180	310	-.631	.219	-.203	-1.447	180	370	-.302	.058	-.123	-.660
180	195	-.230	.051	-.025	-.419	180	311	-.398	.141	-.111	-1.128	180	371	-.291	.046	-.142	-.571
180	196	-.133	.038	.045	-.296	180	312	-.301	.075	-.085	-.795	180	372	-.291	.044	-.149	-.601
180	197	-.109	.043	.053	-.282	180	313	-1.027	.211	-.467	-2.095	180	373	-.299	.044	-.150	-.493
180	198	-.097	.042	.061	-.301	180	314	-.312	.088	-.057	-1.042	180	374	-.304	.051	-.106	-.573
180	199	-.093	.044	.105	-.316	180	315	-1.239	.346	-.144	-2.593	180	375	-.237	.050	-.064	-.536

APPENDIX A -- PRESSURE DATA:

C O L U M B I A P L A Z A , D E N V E R

WD	TAP	CPNEAN	CPRMS	CPMAX	CPMIN	WD	TAP	CPNEAN	CPRMS	CPMAX	CPMIN	WD	TAP	CPNEAN	CPRMS	CPMAX	CPMIN
180	376	-.252	.054	-.054	-.601	180	434	-.305	.051	-.141	-.704	195	43	-.219	.045	-.023	-.462
180	377	-.265	.049	-.112	-.706	180	435	-.251	.066	-.059	-.586	195	44	-.194	.050	-.034	-.512
180	378	-.275	.048	-.141	-.620	180	436	-.314	.059	-.091	-.692	195	45	-.248	.064	-.063	-.601
180	379	-.285	.046	-.138	-.562	180	437	-.248	.066	-.034	-.559	195	46	-.212	.045	-.018	-.478
180	380	-.278	.037	-.118	-.491	180	438	-.279	.069	-.004	-.632	195	47	-.217	.061	.133	-.444
180	381	-.277	.040	-.081	-.440	180	439	-.323	.068	-.138	-.615	195	48	-.184	.055	-.050	-.491
180	382	-.310	.049	-.079	-.552	180	440	-.323	.059	-.152	-.658	195	49	-.124	.052	.229	-.355
180	383	-.259	.050	-.068	-.542	180	441	-.303	.054	-.093	-.787	195	50	-.217	.047	-.018	-.457
180	384	-.265	.052	-.138	-.527	195	1	-.077	.045	.108	-.247	195	51	-.093	.097	.372	-.290
180	385	-.266	.044	-.054	-.475	195	2	-.062	.051	.188	-.224	195	52	.014	.144	.740	-.260
180	386	-.277	.047	-.075	-.495	195	3	-.069	.043	.119	-.239	195	53	-.058	.102	.715	-.362
180	387	-.264	.054	-.109	-.540	195	4	-.082	.049	.104	-.367	195	54	-.015	.104	.573	-.351
180	388	-.254	.048	-.122	-.468	195	5	-.086	.051	.198	-.346	195	55	-.076	.067	.417	-.363
180	389	-.255	.055	-.112	-.538	195	6	-.056	.061	.231	-.247	195	56	-.080	.056	.183	-.414
180	390	-.263	.060	-.123	-.624	195	7	-.041	.068	.225	-.299	195	57	-.044	.073	.432	-.261
180	391	-.262	.050	-.082	-.549	195	8	-.095	.056	.283	-.451	195	58	-.055	.064	.299	-.294
180	392	-.269	.047	-.075	-.464	195	9	-.065	.068	.256	-.335	195	59	-.038	.088	.477	-.331
180	393	-.265	.047	-.063	-.464	195	10	-.039	.076	.265	-.308	195	101	-.721	.155	-.239	-1.328
180	394	-.269	.049	-.102	-.472	195	11	-.109	.078	.189	-.453	195	102	-.770	.176	-.155	-1.318
180	403	-.323	.050	-.177	-.588	195	12	-.093	.068	.251	-.616	195	103	-.576	.167	-.063	-1.269
180	404	-.325	.046	-.147	-.535	195	13	-.091	.053	.103	-.326	195	104	-.499	.195	.046	-1.652
180	405	-.329	.049	-.183	-.552	195	14	-.095	.059	.129	-.435	195	105	-.613	.171	-.083	-1.619
180	406	-.327	.057	-.123	-.574	195	15	-.075	.054	.153	-.324	195	106	-.911	.173	-.427	-2.064
180	407	-.365	.071	-.132	-.786	195	16	-.086	.061	.186	-.362	195	107	-.808	.210	-.280	-1.690
180	408	-.331	.048	-.181	-.540	195	17	-.075	.085	.241	-.441	195	108	-.332	.073	-.101	-.596
180	409	-.368	.065	-.174	-.731	195	18	-.068	.054	.129	-.324	195	109	-.322	.074	-.031	-.717
180	410	-.307	.039	-.152	-.478	195	19	-.102	.040	.054	-.286	195	110	-.450	.105	-.106	-.966
180	411	-.313	.037	-.193	-.440	195	20	-.209	.035	-.091	-.349	195	111	-.533	.147	-.195	-1.164
180	412	-.328	.042	-.188	-.503	195	21	-.110	.033	.029	-.241	195	112	-.856	.172	-.313	-1.562
180	413	-.321	.044	-.195	-.518	195	22	-.173	.036	-.023	-.419	195	113	-.310	.060	-.112	-.596
180	414	-.331	.076	-.117	-.875	195	23	-.196	.032	-.079	-.311	195	114	-.944	.177	-.443	-1.681
180	415	-.320	.050	-.091	-.552	195	24	-.164	.028	-.063	-.269	195	115	-.301	.051	-.152	-.524
180	416	-.326	.047	-.079	-.508	195	25	-.103	.039	.085	-.232	195	116	-.237	.046	-.095	-.509
180	417	-.329	.045	-.070	-.572	195	26	-.081	.039	.129	-.215	195	117	-.246	.092	-.004	-.804
180	418	-.315	.047	-.103	-.567	195	27	-.164	.038	-.018	-.299	195	118	-.548	.261	-.011	-1.440
180	419	-.332	.066	-.095	-.947	195	28	-.169	.028	-.009	-.260	195	119	-.781	.185	-.107	-1.345
180	420	-.352	.065	-.041	-.671	195	29	-.155	.035	-.025	-.324	195	120	-.279	.062	-.086	-.509
180	421	-.336	.053	-.079	-.548	195	30	-.140	.028	-.029	-.281	195	121	-.218	.045	-.040	-.487
180	422	-.327	.050	-.067	-.545	195	31	-.164	.033	-.050	-.365	195	122	-.269	.057	-.051	-.574
180	423	-.329	.053	-.118	-.620	195	32	-.184	.040	-.023	-.435	195	123	-.231	.092	.119	-.739
180	424	-.343	.069	-.138	-.753	195	33	-.234	.046	-.074	-.427	195	124	-.540	.168	-.042	-1.231
180	425	-.320	.064	-.111	-.656	195	34	-.210	.041	-.066	-.532	195	125	-.271	.065	-.069	-.614
180	426	-.314	.056	-.126	-.525	195	35	-.136	.031	-.014	-.263	195	126	-.277	.044	-.109	-.518
180	427	-.331	.056	-.168	-.529	195	36	-.169	.029	-.072	-.294	195	127	-.197	.048	-.025	-.410
180	428	-.320	.050	-.152	-.606	195	37	-.144	.029	-.034	-.250	195	128	-.209	.066	.015	-.554
180	429	-.293	.054	-.070	-.593	195	38	-.226	.050	-.032	-.455	195	129	-.392	.117	.051	-.911
180	430	-.296	.051	-.126	-.563	195	39	-.148	.027	-.050	-.241	195	130	-.363	.080	-.179	-.789
180	431	-.313	.052	-.118	-.568	195	40	-.163	.026	-.066	-.263	195	131	-.341	.094	-.029	-.750
180	432	-.332	.052	-.120	-.551	195	41	-.190	.048	-.016	-.457	195	132	-.291	.078	-.121	-.710
180	433	-.324	.048	-.170	-.516	195	42	-.178	.036	-.005	-.362	195	133	-.202	.038	-.056	-.368

APPENDIX A -- PRESSURE DATA:

C O L U M B I A P L A Z A , D E N V E R

WD	TAP	CPMEAN	CPRMS	CPMAX	CPMIN	WD	TAP	CPMEAN	CPRMS	CPMAX	CPMIN	WD	TAP	CPMEAN	CPRMS	CPMAX	CPMIN
195	134	-.263	.044	-.075	-.439	195	184	-.058	.097	.301	-.379	195	234	-.252	.094	.086	-.718
195	135	-.212	.050	-.045	-.403	195	185	-.045	.077	.326	-.301	195	301	-.545	.155	-.051	-1.230
195	136	-.326	.087	-.062	-.717	195	186	-.050	.090	.355	-.543	195	302	-.630	.166	-.121	-1.323
195	137	-.296	.047	-.060	-.444	195	187	-.128	.065	.141	-.369	195	303	-.658	.148	-.100	-1.136
195	138	-.368	.081	-.148	-.718	195	188	-.059	.094	.308	-.301	195	304	-.797	.171	-.246	-1.622
195	139	-.303	.100	-.099	-.909	195	189	-.055	.097	.387	-.344	195	305	-.375	.136	.046	-.920
195	140	-.188	.048	-.031	-.423	195	190	-.065	.083	.341	-.344	195	306	-.331	.130	.143	-.852
195	141	-.229	.075	-.013	-.779	195	191	-.070	.053	.139	-.312	195	307	-.399	.157	.076	-.960
195	142	-.377	.108	-.106	-.997	195	192	-.053	.057	.305	-.266	195	308	-.597	.170	-.289	-1.933
195	143	-.194	.041	.011	-.349	195	193	-.039	.092	.516	-.430	195	309	-.644	.191	-.231	-1.616
195	144	-.184	.049	.060	-.404	195	194	-.040	.104	.782	-.548	195	310	-.619	.200	-.176	-1.775
195	145	-.185	.051	.025	-.433	195	195	-.129	.063	.163	-.371	195	311	-.550	.202	-.014	-1.389
195	146	-.318	.085	-.038	-.789	195	196	-.060	.084	.292	-.274	195	312	-.480	.182	.026	-1.316
195	147	-.252	.066	.029	-.542	195	197	-.082	.081	.269	-.301	195	313	-.582	.189	-.231	-2.297
195	148	.002	.085	.309	-.260	195	198	-.080	.064	.263	-.349	195	314	-.503	.208	.007	-1.328
195	149	.052	.091	.346	-.252	195	199	-.064	.055	.231	-.291	195	315	-.689	.247	-.169	-2.175
195	150	.028	.099	.343	-.319	195	200	-.042	.061	.191	-.285	195	316	-.656	.214	-.036	-1.641
195	151	.103	.096	.418	-.262	195	201	-.073	.056	.179	-.239	195	317	-.598	.215	-.067	-1.577
195	152	.127	.103	.450	-.229	195	202	-.054	.049	.186	-.213	195	318	-.519	.205	.057	-1.608
195	153	.181	.118	.572	-.290	195	203	.267	.146	.669	-.408	195	319	-.468	.202	.045	-1.246
195	154	.241	.154	.724	-.569	195	204	.185	.123	.572	-.285	195	320	-.684	.200	-.120	-1.507
195	155	-.233	.065	.020	-.437	195	205	.136	.115	.565	-.503	195	321	-.505	.214	-.063	-1.950
195	156	.130	.099	.448	-.214	195	206	.090	.114	.546	-.451	195	322	-.399	.163	-.040	-1.282
195	157	.367	.137	.868	-.272	195	207	-.749	.178	-.204	-1.911	195	323	-.330	.117	.276	-.920
195	158	.392	.165	.924	-.405	195	208	.409	.153	.846	-.166	195	324	-.315	.092	.005	-.797
195	159	-.194	.094	.246	-.497	195	209	-.724	.212	-.200	-2.238	195	325	-.462	.163	-.034	-1.348
195	160	.211	.135	.688	-.207	195	210	.103	.154	.589	-.553	195	326	-.313	.089	.000	-.809
195	161	.282	.160	.761	-.150	195	211	.095	.104	.472	-.245	195	327	-.261	.066	-.043	-.624
195	162	.272	.178	.815	-.199	195	212	.035	.102	.449	-.328	195	328	-.254	.054	-.072	-.495
195	163	.295	.154	.757	-.112	195	213	-.085	.124	.746	-.535	195	329	-.255	.058	-.055	-.672
195	164	.279	.148	.734	-.148	195	214	-.738	.255	.036	-2.120	195	330	-.275	.087	.043	-.761
195	165	.269	.139	.681	-.112	195	215	-.247	.152	.241	-.933	195	331	-.202	.050	-.019	-.462
195	166	.148	.146	.622	-.383	195	216	-.150	.108	.378	-.497	195	332	-.289	.096	.146	-.787
195	167	-.111	.098	.262	-.464	195	217	-.132	.122	.370	-.475	195	333	-.224	.067	.079	-.484
195	168	.089	.144	.584	-.437	195	218	-.147	.146	.421	-.664	195	334	-.197	.063	.219	-.419
195	169	.104	.161	.732	-.460	195	219	-.654	.264	.158	-1.788	195	335	-.189	.057	.172	-.386
195	170	.021	.147	.755	-.450	195	220	-.187	.109	.139	-.764	195	336	-.211	.054	.084	-.433
195	171	-.020	.097	.322	-.329	195	221	-.155	.106	.305	-.721	195	347	-.407	.141	.002	-1.041
195	172	-.038	.080	.333	-.333	195	222	-.140	.097	.485	-.460	195	348	-.370	.119	-.038	-.959
195	173	-.109	.074	.217	-.402	195	223	-.174	.123	.782	-.969	195	349	-.348	.110	.055	-1.563
195	174	-.230	.102	.193	-.693	195	224	-.392	.173	.242	-1.135	195	350	-.328	.106	.033	-1.030
195	175	-.114	.082	.278	-.391	195	225	-.070	.088	.319	-.491	195	351	-.302	.100	-.043	-1.146
195	176	-.003	.114	.334	-.481	195	226	-.051	.087	.367	-.507	195	352	-.304	.093	-.010	-.923
195	177	.022	.119	.371	-.399	195	227	-.041	.087	.375	-.337	195	353	-.307	.090	-.017	-.816
195	178	.000	.103	.304	-.410	195	228	-.284	.103	.066	-.773	195	354	-.301	.085	-.031	-.995
195	179	-.072	.082	.217	-.378	195	229	-.042	.095	.450	-.457	195	355	-.406	.136	-.014	-.893
195	180	-.103	.071	.184	-.386	195	230	-.018	.094	.523	-.412	195	356	-.365	.106	-.050	-.782
195	181	-.117	.072	.122	-.442	195	231	-.001	.104	.468	-.341	195	357	-.302	.073	-.065	-.826
195	182	-.159	.080	.110	-.477	195	232	.002	.123	.629	-.287	195	358	-.299	.072	-.083	-.638
195	183	-.124	.065	.096	-.372	195	233	-.055	.111	.542	-.269	195	359	-.424	.147	-.017	-1.086

APPENDIX A -- PRESSURE DATA

C O L U M B I A P L A Z A , D E N V E R

WD	TAP	CPMEAN	CPRMS	CPMAX	CPMIN	WD	TAP	CPMEAN	CPRMS	CPMAX	CPMIN	WD	TAP	CPMEAN	CPRMS	CPMAX	CPMIN
195	360	-.387	.108	-.077	-1.029	195	418	-.286	.059	-.089	-.777	210	27	-.143	.034	-.002	-.263
195	361	-.376	.092	-.137	-.768	195	419	-.288	.061	-.069	-.667	210	28	-.142	.030	-.027	-.242
195	362	-.358	.079	-.114	-.685	195	420	-.342	.103	-.039	-.910	210	29	-.153	.050	.000	-.404
195	363	-.318	.058	-.157	-.572	195	421	-.311	.077	-.048	-.716	210	30	-.121	.035	.009	-.282
195	364	-.310	.055	-.153	-.533	195	422	-.290	.075	-.103	-.707	210	31	-.182	.061	.020	-.544
195	365	-.309	.045	-.152	-.506	195	423	-.278	.067	-.104	-.588	210	32	-.196	.070	.036	-.678
195	366	-.303	.045	-.114	-.500	195	424	-.274	.067	-.092	-.665	210	33	-.288	.091	-.009	-.662
195	367	-.354	.108	-.036	-1.036	195	425	-.295	.090	-.083	-.935	210	34	-.247	.080	.027	-.777
195	368	-.354	.104	-.084	-.914	195	426	-.275	.068	-.096	-.713	210	35	-.114	.043	.067	-.559
195	369	-.358	.100	-.094	-.881	195	427	-.289	.070	-.113	-.697	210	36	-.170	.041	-.034	-.447
195	370	-.350	.087	-.102	-.778	195	428	-.294	.074	-.064	-.752	210	37	-.122	.036	-.004	-.298
195	371	-.294	.063	-.126	-.612	195	429	-.276	.081	-.030	-.709	210	38	-.270	.097	.005	-.736
195	372	-.273	.057	-.065	-.624	195	430	-.268	.067	-.055	-.581	210	39	-.137	.036	.027	-.341
195	373	-.267	.054	-.039	-.457	195	431	-.284	.070	-.095	-.641	210	40	-.160	.038	-.009	-.395
195	374	-.294	.069	-.033	-.623	195	432	-.302	.074	-.117	-.676	210	41	-.226	.086	.013	-.738
195	375	-.274	.078	-.024	-.891	195	433	-.310	.072	-.145	-.735	210	42	-.186	.061	.054	-.497
195	376	-.281	.076	-.065	-.691	195	434	-.293	.068	-.112	-.638	210	43	-.243	.078	.013	-.643
195	377	-.285	.074	-.082	-.727	195	435	-.227	.064	-.051	-.535	210	44	-.205	.094	.075	-1.014
195	378	-.274	.065	-.053	-.618	195	436	-.312	.092	-.094	-.821	210	45	-.245	.056	.000	-.552
195	379	-.230	.047	-.037	-.429	195	437	-.231	.064	-.069	-.617	210	46	-.209	.054	.056	-.443
195	380	-.230	.046	-.058	-.426	195	438	-.230	.073	-.066	-.764	210	47	-.233	.063	.101	-.373
195	381	-.232	.033	-.030	-.430	195	439	-.270	.084	-.078	-.817	210	48	-.177	.061	-.016	-.621
195	382	-.283	.073	-.055	-.632	195	440	-.293	.096	-.062	-.876	210	49	-.173	.053	.036	-.478
195	383	-.273	.079	-.060	-.745	195	441	-.310	.101	-.088	-.778	210	50	-.232	.071	.081	-.517
195	384	-.238	.060	-.074	-.679	210	1	.039	.050	.312	-.168	210	51	-.176	.043	.049	-.330
195	385	-.217	.043	-.050	-.378	210	2	.102	.062	.443	-.072	210	52	-.213	.059	.034	-.423
195	386	-.237	.064	-.067	-.549	210	3	.063	.050	.272	-.142	210	53	-.099	.072	.150	-.509
195	387	-.284	.097	-.055	-.937	210	4	.044	.050	.226	-.142	210	54	-.110	.050	.084	-.382
195	388	-.249	.051	-.113	-.696	210	5	.044	.069	.332	-.242	210	55	-.031	.081	.236	-.499
195	389	-.231	.049	-.082	-.490	210	6	.137	.079	.461	-.102	210	56	.039	.068	.334	-.303
195	390	-.220	.045	-.065	-.492	210	7	.167	.089	.546	-.058	210	57	.103	.083	.673	-.193
195	391	-.207	.039	-.041	-.383	210	8	-.006	.085	.296	-.289	210	58	.106	.079	.581	-.253
195	392	-.215	.043	.000	-.389	210	9	.074	.094	.585	-.318	210	59	.076	.086	.571	-.220
195	393	-.215	.046	.114	-.438	210	10	.163	.106	.741	-.224	210	101	-.605	.127	-.212	-1.115
195	394	-.241	.057	.028	-.621	210	11	-.136	.149	.445	-.813	210	102	-.695	.138	-.268	-1.250
195	403	-.316	.083	-.007	-.699	210	12	-.087	.081	.269	-.425	210	103	-.585	.149	-.206	-1.254
195	404	-.317	.085	-.002	-.919	210	13	-.027	.086	.413	-.316	210	104	-.534	.159	-.097	-1.328
195	405	-.309	.083	-.062	-.728	210	14	-.028	.124	.526	-.418	210	105	-.556	.132	-.245	-1.403
195	406	-.294	.073	-.077	-.668	210	15	.065	.086	.483	-.330	210	106	-.699	.144	-.325	-1.409
195	407	-.306	.065	-.113	-.591	210	16	.080	.108	.540	-.224	210	107	-.681	.211	-.148	-1.697
195	408	-.300	.072	-.083	-.729	210	17	.115	.076	.491	-.165	210	108	-.391	.076	-.119	-.723
195	409	-.305	.059	-.090	-.728	210	18	.064	.047	.282	-.106	210	109	-.268	.054	-.054	-.500
195	410	-.315	.052	-.141	-.581	210	19	-.150	.036	-.009	-.301	210	110	-.301	.062	-.115	-.655
195	411	-.305	.042	-.178	-.549	210	20	-.199	.037	-.043	-.407	210	111	-.278	.089	-.038	-.752
195	412	-.301	.043	-.174	-.472	210	21	-.142	.036	.000	-.274	210	112	-.615	.146	-.154	-1.310
195	413	-.292	.040	-.173	-.456	210	22	-.148	.038	-.007	-.309	210	113	-.365	.065	-.140	-.662
195	414	-.282	.044	-.084	-.533	210	23	-.175	.035	-.025	-.312	210	114	-.678	.156	-.131	-1.336
195	415	-.357	.087	-.118	-.748	210	24	-.134	.036	-.014	-.246	210	115	-.374	.065	-.170	-.705
195	416	-.329	.070	-.149	-.672	210	25	-.115	.036	.040	-.218	210	116	-.202	.047	-.011	-.365
195	417	-.314	.065	-.136	-.871	210	26	-.107	.040	.102	-.230	210	117	-.147	.062	.085	-.557

APPENDIX A -- PRESSURE DATA:

C O L U M B I A P L A Z A , D E N V E R

WD	TAP	CPMEAN	CPRMS	CPMAX	CPMIN	WD	TAP	CPMEAN	CPRMS	CPMAX	CPMIN	WD	TAP	CPMEAN	CPRMS	CPMAX	CPMIN
210	118	-.323	.202	.126	-1.004	210	168	.216	.110	.657	-.095	210	218	-.254	.078	.093	-.539
210	119	-.362	.158	.031	-1.088	210	169	.294	.142	.901	-.051	210	219	-.604	.190	-.119	-1.799
210	120	-.387	.105	-.160	-.954	210	170	.259	.150	.803	-.166	210	220	-.335	.103	.014	-.823
210	121	-.212	.032	-.045	-.464	210	171	.109	.098	.522	-.260	210	221	-.316	.116	.126	-.763
210	122	-.224	.037	-.027	-.362	210	172	-.093	.076	.314	-.332	210	222	-.253	.109	.093	-.697
210	123	-.227	.135	.074	-.826	210	173	-.122	.075	.158	-.408	210	223	-.226	.079	.030	-.597
210	124	-.502	.167	.011	-1.066	210	174	-.414	.126	.046	-.894	210	224	-.480	.146	-.096	-1.218
210	125	-.332	.104	-.025	-.925	210	175	-.030	.065	.300	-.226	210	225	-.379	.146	-.009	-1.088
210	126	-.238	.058	.069	-.456	210	176	.185	.102	.642	-.138	210	226	-.289	.130	.009	-.928
210	127	-.132	.050	.119	-.322	210	177	.212	.114	.697	-.217	210	227	-.222	.089	.043	-.695
210	128	-.144	.080	.134	-.567	210	178	.205	.114	.670	-.206	210	228	-.306	.094	.016	-.759
210	129	-.392	.145	.056	-1.102	210	179	.043	.088	.397	-.274	210	229	-.380	.161	-.007	-1.228
210	130	-.436	.138	-.157	-1.281	210	180	-.049	.063	.192	-.259	210	230	-.268	.130	.023	-.930
210	131	-.347	.148	.154	-.902	210	181	-.128	.059	.170	-.371	210	231	-.197	.087	.039	-.740
210	132	-.361	.135	-.095	-1.134	210	182	-.256	.078	.126	-.528	210	232	-.187	.061	.089	-.445
210	133	-.157	.054	.049	-.397	210	183	-.033	.059	.264	-.246	210	233	-.200	.054	.346	-.394
210	134	-.190	.055	.011	-.405	210	184	.119	.081	.495	-.131	210	234	-.301	.084	.378	-.810
210	135	-.146	.075	.101	-.517	210	185	-.104	.071	.152	-.446	210	301	-.561	.141	.026	-1.257
210	136	-.330	.136	.156	-.969	210	186	-.246	.092	.030	-.651	210	302	-.585	.127	-.200	-1.116
210	137	-.139	.077	.163	-.468	210	187	-.054	.061	.310	-.365	210	303	-.560	.117	-.191	-1.103
210	138	-.367	.143	.150	-.838	210	188	.105	.072	.529	-.135	210	304	-.627	.158	-.219	-1.280
210	139	-.390	.163	-.101	-1.455	210	189	.141	.086	.636	-.170	210	305	-.382	.104	-.038	-.881
210	140	-.093	.054	.180	-.325	210	190	.155	.091	.626	-.107	210	306	-.410	.130	.061	-.982
210	141	-.207	.128	.288	-.780	210	191	.115	.087	.486	-.128	210	307	-.479	.139	.101	-1.042
210	142	-.456	.165	-.131	-1.316	210	192	.086	.080	.410	-.153	210	308	-.406	.069	-.165	-.627
210	143	-.142	.051	.067	-.331	210	193	-.166	.113	.174	-.627	210	309	-.417	.084	-.167	-.874
210	144	-.091	.051	.165	-.255	210	194	-.217	.085	.064	-.603	210	310	-.420	.100	-.136	-1.038
210	145	-.089	.052	.203	-.306	210	195	-.044	.058	.312	-.244	210	311	-.435	.117	-.113	-1.103
210	146	-.256	.123	.117	-.832	210	196	.080	.057	.331	-.103	210	312	-.446	.125	-.115	-1.138
210	147	-.078	.096	.289	-.358	210	197	.104	.077	.502	-.103	210	313	-.384	.070	-.183	-.690
210	148	.097	.110	.455	-.290	210	198	.108	.082	.539	-.115	210	314	-.446	.135	-.085	-1.050
210	149	.116	.112	.573	-.314	210	199	.127	.083	.537	-.153	210	315	-.403	.100	.009	-.964
210	150	.084	.122	.549	-.365	210	200	.155	.093	.604	-.087	210	316	-.424	.105	-.144	-1.021
210	151	.154	.117	.520	-.218	210	201	.080	.060	.348	-.085	210	317	-.450	.107	-.110	-1.029
210	152	.163	.124	.528	-.229	210	202	.111	.072	.543	-.045	210	318	-.463	.112	.031	-1.031
210	153	.218	.126	.615	-.236	210	203	.043	.169	.514	-.770	210	319	-.484	.126	.045	-.997
210	154	.201	.139	.615	-.305	210	204	.059	.099	.401	-.278	210	320	-.560	.163	-.186	-1.336
210	155	.003	.096	.313	-.316	210	205	.010	.093	.355	-.332	210	321	-.575	.196	-.048	-1.838
210	156	.270	.123	.659	-.167	210	206	-.041	.086	.292	-.371	210	322	-.550	.200	-.021	-1.360
210	157	.395	.146	.957	.002	210	207	-.495	.091	-.199	-.841	210	323	-.510	.182	.031	-1.244
210	158	.316	.157	.889	-.206	210	208	.148	.183	.654	-.643	210	324	-.508	.175	-.052	-1.214
210	159	-.036	.106	.448	-.358	210	209	-.438	.077	-.167	-.772	210	325	-.443	.130	-.167	-1.143
210	160	.323	.134	.745	-.073	210	210	-.138	.214	.432	-.985	210	326	-.384	.116	-.092	-1.137
210	161	.425	.145	.836	-.097	210	211	.088	.093	.400	-.359	210	327	-.340	.107	-.028	-.851
210	162	.437	.165	.947	-.066	210	212	.048	.082	.337	-.271	210	328	-.318	.093	-.054	-.738
210	163	.442	.147	.884	.013	210	213	-.054	.075	.241	-.360	210	329	-.321	.094	-.031	-.790
210	164	.384	.136	.778	-.015	210	214	-.437	.096	-.199	-1.256	210	330	-.295	.082	.028	-.709
210	165	.288	.116	.644	-.067	210	215	-.530	.171	.000	-1.307	210	331	-.226	.066	.031	-.566
210	166	.034	.158	.555	-.695	210	216	-.273	.186	.125	-1.149	210	332	-.313	.092	.026	-.726
210	167	-.055	.061	.233	-.282	210	217	-.188	.073	.082	-.589	210	333	-.290	.071	-.055	-.588

APPENDIX A -- PRESSURE DATA:

C O L U M B I A P L A Z A , D E N V E R

WD	TAP	CPMEAN	CPRMS	CPMAX	CPMIN	WD	TAP	CPMEAN	CPRMS	CPMAX	CPMIN	WD	TAP	CPMEAN	CPRMS	CPMAX	CPMIN
210	334	-.267	.072	.002	-.543	210	394	-.290	.111	-.025	-.827	225	11	-.088	.167	.435	-.772
210	335	-.233	.066	.082	-.554	210	403	-.391	.102	-.058	-1.243	225	12	-.073	.103	.441	-.386
210	336	-.228	.067	.038	-.620	210	404	-.391	.099	-.113	-.974	225	13	-.043	.111	.425	-.350
210	347	-.373	.100	-.064	-.846	210	405	-.392	.084	-.161	-.858	225	14	-.056	.143	.435	-.664
210	348	-.340	.087	.000	-.808	210	406	-.373	.072	-.153	-.774	225	15	.043	.100	.385	-.371
210	349	-.348	.089	-.052	-.986	210	407	-.376	.065	-.127	-.601	225	16	.049	.124	.569	-.306
210	350	-.353	.089	-.007	-.869	210	408	-.390	.085	-.129	-.898	225	17	.147	.082	.484	-.127
210	351	-.366	.085	-.052	-.655	210	409	-.377	.065	-.178	-.625	225	18	.098	.051	.353	-.069
210	352	-.374	.086	-.019	-.651	210	410	-.426	.084	-.226	-.914	225	19	-.160	.034	-.034	-.289
210	353	-.372	.088	-.060	-.774	210	411	-.408	.070	-.233	-.848	225	20	-.196	.035	-.059	-.366
210	354	-.364	.091	-.082	-.860	210	412	-.399	.064	-.196	-.735	225	21	-.145	.032	-.036	-.289
210	355	-.374	.095	-.097	-.822	210	413	-.384	.060	-.207	-.682	225	22	-.137	.040	-.025	-.284
210	356	-.337	.078	-.092	-.669	210	414	-.369	.062	-.196	-.669	225	23	-.144	.031	.018	-.289
210	357	-.358	.074	-.100	-.695	210	415	-.513	.159	-.157	-1.456	225	24	-.121	.036	.005	-.256
210	358	-.358	.079	-.094	-.754	210	416	-.472	.123	-.212	-1.149	225	25	-.112	.036	.045	-.220
210	359	-.421	.098	-.101	-.928	210	417	-.446	.122	-.145	-1.127	225	26	-.113	.037	.057	-.238
210	360	-.387	.078	-.158	-.797	210	418	-.407	.107	-.160	-.975	225	27	-.110	.037	.203	-.230
210	361	-.389	.068	-.183	-.724	210	419	-.403	.106	-.148	-.973	225	28	-.099	.044	.169	-.210
210	362	-.367	.062	-.089	-.677	210	420	-.459	.221	.129	-1.451	225	29	-.135	.047	.041	-.352
210	363	-.346	.051	-.153	-.580	210	421	-.418	.154	-.021	-1.206	225	30	-.093	.042	.124	-.215
210	364	-.354	.056	-.127	-.615	210	422	-.388	.133	-.080	-1.119	225	31	-.186	.058	.021	-.567
210	365	-.377	.058	-.181	-.645	210	423	-.356	.104	-.118	-.832	225	32	-.251	.076	-.034	-.734
210	366	-.396	.068	-.179	-.707	210	424	-.344	.101	-.064	-.806	225	33	-.310	.100	.102	-.705
210	367	-.453	.146	-.028	-1.075	210	425	-.401	.203	.028	-1.409	225	34	-.281	.095	.032	-.898
210	368	-.418	.123	-.099	-1.047	210	426	-.361	.147	-.007	-1.053	225	35	-.103	.043	.039	-.349
210	369	-.395	.098	-.136	-.862	210	427	-.381	.148	-.023	-1.151	225	36	-.182	.040	-.057	-.400
210	370	-.358	.081	-.101	-.667	210	428	-.352	.120	-.094	-1.389	225	37	-.117	.038	.034	-.336
210	371	-.315	.067	-.101	-.613	210	429	-.366	.168	.023	-1.353	225	38	-.289	.090	-.034	-.623
210	372	-.327	.076	-.059	-.676	210	430	-.351	.140	.002	-1.005	225	39	-.128	.036	-.011	-.303
210	373	-.368	.090	-.071	-.810	210	431	-.374	.144	-.030	-1.056	225	40	-.166	.034	-.064	-.286
210	374	-.426	.116	-.092	-.987	210	432	-.392	.147	-.085	-1.306	225	41	-.247	.083	-.007	-.680
210	375	-.344	.109	.000	-.867	210	433	-.366	.110	-.111	-.966	225	42	-.210	.062	-.025	-.545
210	376	-.331	.099	-.068	-.985	210	434	-.341	.102	-.119	-.998	225	43	-.275	.087	-.014	-.661
210	377	-.321	.087	-.084	-.758	210	435	-.285	.122	-.009	-.952	225	44	-.322	.142	-.066	-1.066
210	378	-.294	.075	-.072	-.659	210	436	-.356	.121	-.097	-.907	225	45	-.248	.052	-.043	-.491
210	379	-.248	.062	-.007	-.458	210	437	-.280	.126	.032	-1.199	225	46	-.250	.050	-.105	-.497
210	380	-.257	.072	-.007	-.558	210	438	-.297	.132	.009	-1.217	225	47	-.265	.057	-.025	-.615
210	381	-.275	.098	.005	-.706	210	439	-.357	.150	-.028	-1.155	225	48	-.215	.105	.021	-1.054
210	382	-.364	.142	-.007	-.915	210	440	-.367	.147	-.021	-1.043	225	49	-.210	.047	-.055	-.557
210	383	-.278	.084	-.035	-.797	210	441	-.367	.144	-.081	-1.217	225	50	-.308	.073	-.073	-.591
210	384	-.256	.062	-.028	-.563	225	1	.068	.045	.261	-.109	225	51	-.209	.036	-.082	-.353
210	385	-.234	.084	.041	-.591	225	2	.102	.050	.318	-.119	225	52	-.246	.064	-.032	-.514
210	386	-.304	.123	.044	-.797	225	3	.076	.046	.292	-.064	225	53	-.073	.080	.239	-.455
210	387	-.288	.093	-.060	-.907	225	4	.065	.048	.247	-.112	225	54	-.132	.054	.014	-.485
210	388	-.248	.057	-.060	-.625	225	5	.051	.076	.343	-.321	225	55	-.010	.077	.385	-.264
210	389	-.224	.057	.023	-.619	225	6	.144	.060	.467	-.018	225	56	.022	.079	.295	-.338
210	390	-.209	.051	.076	-.506	225	7	.175	.076	.529	-.014	225	57	.137	.071	.436	-.073
210	391	-.209	.063	.071	-.495	225	8	.024	.086	.393	-.295	225	58	.136	.064	.414	-.039
210	392	-.225	.070	-.035	-.523	225	9	.110	.081	.507	-.116	225	59	.116	.080	.421	-.178
210	393	-.237	.080	.023	-.573	225	10	.175	.091	.653	-.044	225	101	-.578	.132	-.116	-1.294

APPENDIX A -- PRESSURE DATA:

C O L U M B I A P L A Z A , D E N V E R

WD	TAP	CPMEAN	CPRMS	CPMAX	CPMIN	WD	TAP	CPMEAN	CPRMS	CPMAX	CPMIN	WD	TAP	CPMEAN	CPRMS	CPMAX	CPMIN
225	102	-.655	.129	-.234	-1.139	225	152	.164	.109	.512	-.235	225	202	.120	.049	.337	-.041
225	103	-.553	.129	-.145	-1.385	225	153	.163	.117	.611	-.261	225	203	-.431	.184	.155	-1.120
225	104	-.544	.148	-.068	-1.405	225	154	.029	.125	.526	-.385	225	204	-.102	.077	.147	-.399
225	105	-.534	.121	-.248	-1.100	225	155	.247	.134	.640	-.166	225	205	-.123	.072	.125	-.375
225	106	-.664	.132	-.318	-1.457	225	156	.371	.137	.773	-.059	225	206	-.151	.065	.080	-.385
225	107	-.614	.196	-.125	-1.817	225	157	.323	.126	.692	-.100	225	207	-.369	.066	-.123	-.622
225	108	-.437	.077	-.217	-.707	225	158	.053	.139	.522	-.475	225	208	-.368	.224	.328	-1.194
225	109	-.137	.067	.089	-.373	225	159	.214	.154	.819	-.230	225	209	-.331	.055	-.167	-.546
225	110	-.105	.089	.159	-.462	225	160	.425	.146	.951	.031	225	210	-.622	.212	.021	-1.347
225	111	-.067	.083	.199	-.441	225	161	.418	.152	.904	.013	225	211	-.144	.138	.201	-.935
225	112	-.229	.173	.336	-.858	225	162	.390	.162	.922	-.053	225	212	-.096	.070	.186	-.643
225	113	-.397	.063	-.183	-.645	225	163	.373	.142	.875	-.043	225	213	-.153	.057	.192	-.357
225	114	-.226	.198	.555	-.836	225	164	.314	.132	.742	-.031	225	214	-.315	.054	-.119	-.616
225	115	-.392	.066	-.208	-.949	225	165	.199	.110	.609	-.239	225	215	-.748	.163	-.241	-1.506
225	116	-.075	.061	.187	-.257	225	166	-.280	.139	.190	-.761	225	216	-.630	.218	-.037	-1.462
225	117	.032	.076	.283	-.234	225	167	.014	.082	.427	-.282	225	217	-.327	.131	.016	-.875
225	118	.033	.123	.380	-.708	225	168	.213	.089	.593	-.030	225	218	-.286	.068	-.092	-.612
225	119	-.118	.198	.474	-.803	225	169	.247	.095	.741	-.007	225	219	-.416	.102	-.155	-1.011
225	120	-.441	.118	-.134	-1.010	225	170	.229	.114	.787	-.069	225	220	-.596	.142	-.225	-1.214
225	121	-.167	.047	-.004	-.399	225	171	.212	.108	.647	-.103	225	221	-.492	.127	-.139	-.984
225	122	-.161	.055	.055	-.467	225	172	.114	.087	.450	-.184	225	222	-.381	.107	-.092	-.882
225	123	-.116	.114	.183	-.727	225	173	-.071	.076	.252	-.399	225	223	-.331	.073	-.074	-.627
225	124	-.298	.140	.176	-.854	225	174	-.536	.104	-.201	-.891	225	224	-.439	.099	-.172	-.902
225	125	-.425	.130	-.103	-1.000	225	175	-.005	.066	.383	-.204	225	225	-.524	.136	-.160	-1.160
225	126	-.211	.048	-.004	-.396	225	176	.158	.072	.450	-.057	225	226	-.346	.127	-.037	-.969
225	127	-.090	.043	.112	-.295	225	177	.191	.092	.573	-.099	225	227	-.241	.077	-.032	-.708
225	128	-.091	.083	.202	-.562	225	178	.210	.106	.710	-.074	225	228	-.374	.103	-.096	-.960
225	129	-.279	.126	.201	-.777	225	179	.145	.107	.624	-.193	225	229	-.493	.136	-.113	-1.186
225	130	-.506	.117	-.230	-1.112	225	180	.051	.091	.458	-.359	225	230	-.302	.124	.007	-.960
225	131	-.174	.109	.215	-.741	225	181	-.099	.083	.225	-.504	225	231	-.201	.074	-.005	-.537
225	132	-.428	.112	-.162	-1.047	225	182	-.404	.083	-.155	-.810	225	232	-.213	.058	-.039	-.468
225	133	-.120	.045	.080	-.297	225	183	.037	.071	.427	-.179	225	233	-.249	.048	-.069	-.442
225	134	-.133	.046	.075	-.318	225	184	.113	.067	.470	-.109	225	234	-.384	.091	-.135	-1.036
225	135	-.061	.057	.159	-.358	225	185	-.079	.070	.266	-.337	225	301	-.541	.129	-.161	-1.174
225	136	-.182	.109	.167	-.659	225	186	-.301	.074	-.025	-.620	225	302	-.557	.121	-.192	-1.199
225	137	-.049	.058	.165	-.370	225	187	.023	.070	.491	-.248	225	303	-.547	.127	-.169	-1.142
225	138	-.211	.109	.164	-.652	225	188	.104	.061	.426	-.083	225	304	-.527	.142	-.146	-1.095
225	139	-.445	.127	-.172	-1.020	225	189	.119	.065	.431	-.124	225	305	-.345	.096	-.028	-.684
225	140	-.033	.050	.160	-.237	225	190	.121	.067	.470	-.132	225	306	-.380	.124	.014	-.944
225	141	-.071	.101	-.037	-.594	225	191	.113	.066	.500	-.062	225	307	-.533	.147	-.120	-1.252
225	142	-.523	.152	-.170	-1.391	225	192	.102	.073	.493	-.120	225	308	-.316	.055	-.146	-.536
225	143	-.112	.044	.054	-.291	225	193	-.106	.111	.330	-.532	225	309	-.322	.057	-.142	-.530
225	144	-.043	.048	.162	-.237	225	194	-.257	.076	.025	-.666	225	310	-.318	.066	-.134	-.648
225	145	-.032	.053	.228	-.257	225	195	.032	.074	.415	-.188	225	311	-.311	.072	-.078	-.806
225	146	-.140	.107	.192	-.586	225	196	.098	.060	.360	-.083	225	312	-.316	.074	-.094	-.733
225	147	-.142	.117	.510	-.351	225	197	.098	.067	.482	-.074	225	313	-.318	.050	-.111	-.490
225	148	-.199	.122	.619	-.272	225	198	.102	.062	.401	-.057	225	314	-.319	.077	-.077	-.772
225	149	-.183	.115	.627	-.230	225	199	.127	.055	.370	-.028	225	315	-.298	.053	-.099	-.519
225	150	-.135	.121	.551	-.345	225	200	.164	.070	.514	-.034	225	316	-.310	.052	-.141	-.519
225	151	-.155	.110	.535	-.262	225	201	.093	.048	.329	-.053	225	317	-.331	.049	-.159	-.568

APPENDIX A -- PRESSURE DATA:

C O L U M B I A P L A Z A , D E N V E R

WD	TAP	CPMEAN	CPRMS	CPMAX	CPMIN	WD	TAP	CPMEAN	CPRMS	CPMAX	CPMIN	WD	TAP	CPMEAN	CPRMS	CPMAX	CPMIN
225	318	-.337	.055	-.174	-.702	225	378	-.272	.060	-.096	-.606	225	436	-.400	.113	-.139	-.917
225	319	-.354	.065	-.197	-.775	225	379	-.302	.094	-.037	-.651	225	437	-.285	.102	-.051	-.822
225	320	-.386	.094	-.270	-.911	225	380	-.321	.101	-.056	-.822	225	438	-.314	.110	-.035	-.865
225	321	-.424	.097	-.133	-1.044	225	381	-.321	.111	-.016	-.814	225	439	-.384	.117	-.068	-.943
225	322	-.431	.100	-.120	-1.397	225	382	-.358	.126	-.030	-.870	225	440	-.394	.118	-.086	-.880
225	323	-.429	.089	-.143	-.973	225	383	-.248	.068	-.005	-.480	225	441	-.409	.122	-.065	-1.131
225	324	-.472	.104	-.200	-.914	225	384	-.242	.058	-.030	-.507	240	1	.043	.038	.189	-.094
225	325	-.415	.088	-.118	-.824	225	385	-.263	.092	.000	-.590	240	2	.058	.040	.232	-.066
225	326	-.404	.084	-.129	-.918	225	386	-.305	.110	-.030	-.746	240	3	.043	.036	.194	-.068
225	327	-.408	.093	-.108	-.994	225	387	-.255	.066	.067	-.568	240	4	.034	.044	.201	-.181
225	328	-.371	.086	-.063	-.777	225	388	-.244	.055	-.009	-.512	240	5	.010	.057	.198	-.243
225	329	-.338	.095	-.017	-.829	225	389	-.230	.048	-.032	-.426	240	6	.075	.046	.292	-.091
225	330	-.353	.084	-.115	-.838	225	390	-.236	.053	-.054	-.480	240	7	.099	.058	.378	-.070
225	331	-.268	.088	.174	-.766	225	391	-.257	.079	-.032	-.607	240	8	-.011	.067	.228	-.303
225	332	-.375	.098	-.099	-1.109	225	392	-.273	.084	-.009	-.572	240	9	.042	.064	.308	-.213
225	333	-.348	.074	-.180	-.689	225	393	-.266	.088	.060	-.565	240	10	.087	.069	.522	-.112
225	334	-.344	.078	-.042	-.730	225	394	-.297	.097	-.007	-.674	240	11	-.117	.124	.288	-.810
225	335	-.289	.074	-.047	-.611	225	403	-.428	.104	-.150	-1.018	240	12	-.096	.072	.283	-.366
225	336	-.264	.087	.023	-.597	225	404	-.405	.080	-.162	-.774	240	13	-.062	.092	.330	-.368
225	347	-.305	.073	-.016	-.594	225	405	-.417	.073	-.199	-.862	240	14	-.062	.119	.440	-.633
225	348	-.312	.073	-.059	-.592	225	406	-.401	.067	-.178	-.708	240	15	.017	.079	.389	-.322
225	349	-.354	.080	-.069	-.634	225	407	-.412	.064	-.178	-.641	240	16	.013	.114	.554	-.317
225	350	-.364	.083	-.038	-.805	225	408	-.411	.091	-.118	-.964	240	17	.084	.070	.362	-.092
225	351	-.357	.076	-.089	-.646	225	409	-.388	.057	-.203	-.582	240	18	.051	.042	.262	-.075
225	352	-.357	.081	-.101	-.897	225	410	-.434	.082	-.241	-.888	240	19	-.165	.028	-.068	-.293
225	353	-.355	.088	-.038	-.916	225	411	-.422	.068	-.267	-.744	240	20	-.210	.028	-.061	-.339
225	354	-.363	.093	-.019	-.979	225	412	-.398	.067	-.197	-.711	240	21	-.156	.026	-.054	-.252
225	355	-.295	.063	-.089	-.573	225	413	-.387	.062	-.201	-.736	240	22	-.155	.033	-.032	-.264
225	356	-.302	.062	-.099	-.552	225	414	-.367	.062	-.185	-.659	240	23	-.171	.026	-.068	-.288
225	357	-.356	.072	-.121	-.717	225	415	-.525	.135	-.208	-1.385	240	24	-.139	.027	-.041	-.228
225	358	-.372	.082	-.129	-.767	225	416	-.488	.118	-.197	-1.107	240	25	-.151	.027	-.025	-.236
225	359	-.327	.050	-.164	-.585	225	417	-.485	.120	-.199	-1.040	240	26	-.153	.028	.011	-.246
225	360	-.325	.046	-.157	-.477	225	418	-.454	.110	-.157	-1.037	240	27	-.154	.027	-.043	-.232
225	361	-.341	.042	-.215	-.492	225	419	-.446	.106	-.178	-.997	240	28	-.144	.025	-.016	-.231
225	362	-.343	.046	-.192	-.509	225	420	-.397	.164	.051	-1.237	240	29	-.159	.041	-.036	-.359
225	363	-.357	.049	-.223	-.545	225	421	-.431	.132	-.033	-1.138	240	30	-.137	.027	-.057	-.228
225	364	-.376	.054	-.209	-.611	225	422	-.448	.132	-.072	-1.013	240	31	-.208	.053	-.059	-.551
225	365	-.393	.057	-.230	-.642	225	423	-.429	.120	-.122	-1.020	240	32	-.257	.067	-.048	-.869
225	366	-.406	.069	-.202	-.730	225	424	-.408	.116	-.097	-.998	240	33	-.265	.065	-.049	-.638
225	367	-.376	.073	-.117	-.674	225	425	-.368	.148	.016	-.967	240	34	-.253	.060	-.068	-.535
225	368	-.334	.064	-.108	-.583	225	426	-.363	.118	.030	-.807	240	35	-.133	.032	-.018	-.250
225	369	-.335	.057	-.073	-.547	225	427	-.398	.117	.035	-.960	240	36	-.208	.029	-.102	-.323
225	370	-.329	.056	-.120	-.559	225	428	-.390	.101	-.158	-1.003	240	37	-.139	.026	-.047	-.231
225	371	-.361	.069	-.150	-.639	225	429	-.350	.137	-.026	-.986	240	38	-.265	.060	-.050	-.535
225	372	-.390	.080	-.146	-.775	225	430	-.358	.120	.005	-.958	240	39	-.156	.027	-.043	-.286
225	373	-.437	.087	-.166	-.923	225	431	-.394	.118	-.061	-.922	240	40	-.194	.026	-.088	-.326
225	374	-.477	.110	-.148	-1.005	225	432	-.418	.113	-.076	-.915	240	41	-.217	.053	-.016	-.474
225	375	-.325	.080	-.028	-.691	225	433	-.419	.105	-.126	-.909	240	42	-.207	.040	-.046	-.405
225	376	-.299	.069	-.035	-.761	225	434	-.396	.103	-.104	-1.037	240	43	-.261	.070	-.041	-.538
225	377	-.278	.063	-.044	-.528	225	435	-.282	.110	-.033	-.943	240	44	-.306	.114	-.038	-1.077

WD	TAP	CPMEAN	CPRMS	CPMAX	CPMIN	WD	TAP	CPMEAN	CPRMS	CPMAX	CPMIN	WD	TAP	CPMEAN	CPRMS	CPMAX	CPMIN
240	45	-.263	.053	-.090	-.501	240	136	-.132	.064	.142	-.536	240	186	-.263	.054	-.019	-.452
240	46	-.276	.055	-.121	-.544	240	137	-.053	.036	.065	-.256	240	187	.009	.044	.196	-.193
240	47	-.291	.058	-.032	-.619	240	138	-.121	.063	.079	-.454	240	188	.068	.047	.260	-.118
240	48	-.240	.106	-.023	-.894	240	139	-.442	.119	-.135	-1.204	240	189	.070	.053	.322	-.137
240	49	-.201	.048	-.011	-.416	240	140	-.037	.035	.086	-.166	240	190	.072	.054	.309	-.172
240	50	-.312	.066	-.125	-.626	240	141	-.047	.055	.129	-.305	240	191	.061	.052	.352	-.120
240	51	-.225	.040	-.065	-.410	240	142	-.434	.117	-.073	-.999	240	192	.054	.064	.365	-.114
240	52	-.224	.057	-.029	-.439	240	143	-.093	.031	.038	-.213	240	193	-.105	.110	.380	-.424
240	53	-.093	.062	.258	-.346	240	144	-.043	.034	.089	-.155	240	194	-.221	.059	.030	-.483
240	54	-.127	.041	.025	-.326	240	145	-.045	.032	.134	-.154	240	195	.005	.045	.171	-.162
240	55	-.048	.057	.218	-.297	240	146	-.065	.054	.157	-.339	240	196	.061	.045	.228	-.085
240	56	-.034	.061	.201	-.290	240	147	.139	.175	.593	-.297	240	197	.059	.051	.232	-.151
240	57	.067	.065	.400	-.162	240	148	.084	.165	.509	-.381	240	198	.048	.047	.262	-.139
240	58	.063	.058	.385	-.100	240	149	.057	.163	.561	-.472	240	199	.066	.041	.276	-.090
240	59	.046	.072	.374	-.182	240	150	.062	.156	.641	-.421	240	200	.091	.053	.308	-.053
240	101	-.546	.165	.020	-1.189	240	151	.087	.135	.520	-.409	240	201	.054	.042	.260	-.074
240	102	-.606	.154	-.018	-1.171	240	152	.061	.133	.505	-.352	240	202	.063	.043	.236	-.069
240	103	-.574	.150	-.066	-1.237	240	153	.047	.137	.499	-.412	240	203	-.745	.226	-.137	-1.594
240	104	-.674	.175	-.232	-1.368	240	154	-.108	.114	.348	-.560	240	204	-.282	.076	-.002	-.582
240	105	-.791	.184	-.276	-1.747	240	155	.289	.192	.801	-.290	240	205	-.239	.058	.019	-.457
240	106	-.623	.179	-.172	-1.651	240	156	.264	.187	.834	-.206	240	206	-.227	.057	-.007	-.454
240	107	-.469	.173	-.011	-1.417	240	157	.148	.149	.585	-.347	240	207	-.297	.057	-.107	-.527
240	108	-.522	.195	-.199	-1.129	240	158	-.149	.121	.293	-.595	240	208	-.732	.231	-.062	-1.798
240	109	-.006	.119	.378	-.394	240	159	.149	.121	.748	-.350	240	209	-.279	.047	-.118	-.483
240	110	.072	.142	.542	-.377	240	160	.220	.115	.763	-.066	240	210	-.789	.189	-.176	-1.563
240	111	.034	.143	.460	-.438	240	161	.234	.116	.717	-.036	240	211	-.329	.136	-.016	-1.104
240	112	.099	.213	.646	-.752	240	162	.240	.124	.719	-.068	240	212	-.230	.062	-.021	-.743
240	113	-.486	.093	-.174	-.826	240	163	.211	.129	.742	-.093	240	213	-.240	.040	-.067	-.497
240	114	.333	.270	.932	-.630	240	164	.162	.129	.675	-.173	240	214	-.287	.040	-.155	-.502
240	115	-.486	.127	-.144	-1.140	240	165	.031	.115	.459	-.329	240	215	-.745	.164	-.362	-1.492
240	116	.041	.146	.553	-.359	240	166	-.360	.104	.011	-.772	240	216	-.511	.128	-.175	-1.075
240	117	.089	.136	.612	-.200	240	167	.036	.062	.336	-.226	240	217	-.374	.094	-.100	-.919
240	118	.119	.133	.701	-.326	240	168	.114	.071	.458	-.108	240	218	-.306	.055	-.127	-.678
240	119	.058	.176	.779	-.536	240	169	.121	.073	.501	-.096	240	219	-.290	.057	-.142	-.626
240	120	-.535	.140	-.144	-1.102	240	170	.127	.074	.485	-.093	240	220	-.646	.168	-.258	-1.392
240	121	-.162	.053	-.007	-.412	240	171	.091	.082	.494	-.111	240	221	-.404	.102	-.104	-.817
240	122	-.078	.050	.115	-.357	240	172	.037	.082	.416	-.168	240	222	-.314	.068	-.144	-.671
240	123	-.044	.053	.177	-.321	240	173	-.084	.087	.394	-.361	240	223	-.280	.049	-.128	-.490
240	124	-.134	.108	.175	-.600	240	174	-.423	.083	-.121	-.840	240	224	-.321	.076	-.104	-.737
240	125	-.485	.122	-.189	-1.422	240	175	-.009	.052	.288	-.219	240	225	-.414	.093	-.128	-.868
240	126	-.135	.045	.040	-.339	240	176	.089	.063	.378	-.128	240	226	-.291	.081	-.063	-.667
240	127	-.083	.040	.080	-.277	240	177	.106	.075	.465	-.153	240	227	-.212	.055	-.037	-.434
240	128	-.074	.054	.102	-.401	240	178	.124	.084	.508	-.139	240	228	-.321	.070	-.110	-.720
240	129	-.196	.085	.105	-.617	240	179	.079	.100	.539	-.377	240	229	-.395	.098	-.100	-.917
240	130	-.437	.098	-.198	-.926	240	180	.016	.094	.432	-.397	240	230	-.256	.085	.014	-.732
240	131	-.147	.068	.084	-.460	240	181	-.106	.091	.269	-.447	240	231	-.176	.060	.074	-.517
240	132	-.435	.098	-.199	-.859	240	182	-.395	.073	-.193	-.722	240	232	-.193	.057	.005	-.400
240	133	-.113	.034	.027	-.238	240	183	.017	.047	.244	-.189	240	233	-.241	.045	-.077	-.409
240	134	-.063	.030	.073	-.187	240	184	.070	.051	.330	-.202	240	234	-.354	.076	-.072	-.938
240	135	-.049	.033	.075	-.301	240	185	-.097	.070	.206	-.299	240	301	-.556	.143	-.151	-1.050

APPENDIX A -- PRESSURE DATA

C O L U M B I A P L A Z A , D E N V E R

WD	TAP	CPMEAN	CPRMS	CPMAX	CPMIN	WD	TAP	CPMEAN	CPRMS	CPMAX	CPMIN	WD	TAP	CPMEAN	CPRMS	CPMAX	CPMIN
240	302	-.561	.148	-.092	-1.174	240	362	-.336	.044	-.206	-.522	240	420	-.311	.092	-.053	-.698
240	303	-.468	.148	-.038	-1.018	240	363	-.352	.053	-.184	-.612	240	421	-.356	.098	-.028	-.762
240	304	-.368	.133	-.024	-1.027	240	364	-.378	.066	-.166	-.700	240	422	-.405	.104	-.085	-.857
240	305	-.297	.085	.110	-.741	240	365	-.402	.085	-.108	-.806	240	423	-.446	.111	-.130	-1.061
240	306	-.353	.127	-.080	-.964	240	366	-.448	.128	-.035	-1.084	240	424	-.447	.113	-.182	-.956
240	307	-.660	.181	-.087	-1.481	240	367	-.281	.050	-.102	-.520	240	425	-.284	.082	-.051	-.885
240	308	-.282	.050	-.097	-.523	240	368	-.291	.049	-.097	-.490	240	426	-.291	.082	-.069	-.706
240	309	-.281	.053	-.067	-.466	240	369	-.318	.054	-.151	-.557	240	427	-.324	.089	-.086	-.730
240	310	-.271	.055	-.033	-.539	240	370	-.325	.061	-.144	-.567	240	428	-.389	.084	-.168	-.825
240	311	-.263	.055	-.084	-.555	240	371	-.338	.078	-.123	-.661	240	429	-.282	.076	-.058	-.665
240	312	-.281	.060	-.062	-.589	240	372	-.356	.090	-.073	-.721	240	430	-.294	.078	-.057	-.688
240	313	-.280	.046	-.141	-.461	240	373	-.387	.112	-.072	-.940	240	431	-.324	.083	-.112	-.716
240	314	-.281	.059	-.073	-.600	240	374	-.411	.133	-.021	-1.091	240	432	-.377	.090	-.127	-.977
240	315	-.265	.041	-.128	-.536	240	375	-.262	.053	-.061	-.475	240	433	-.402	.096	-.158	-.855
240	316	-.274	.039	-.140	-.532	240	376	-.254	.047	-.040	-.461	240	434	-.393	.097	-.135	-.841
240	317	-.284	.033	-.167	-.499	240	377	-.267	.047	-.124	-.470	240	435	-.237	.069	-.026	-.577
240	318	-.282	.033	-.123	-.404	240	378	-.283	.059	-.100	-.537	240	436	-.398	.107	-.101	-.905
240	319	-.283	.034	-.165	-.413	240	379	-.295	.080	-.055	-.732	240	437	-.233	.065	-.060	-.635
240	320	-.277	.055	-.090	-.648	240	380	-.288	.080	-.081	-.674	240	438	-.256	.083	-.016	-.667
240	321	-.285	.043	-.146	-.464	240	381	-.277	.084	-.064	-.674	240	439	-.338	.096	-.067	-.802
240	322	-.286	.041	-.142	-.463	240	382	-.297	.083	-.093	-.649	240	440	-.388	.110	-.094	-.972
240	323	-.281	.042	-.163	-.496	240	383	-.258	.055	-.005	-.472	240	441	-.405	.119	-.109	-1.024
240	324	-.307	.056	-.125	-.565	240	384	-.249	.053	-.035	-.426	255	1	-.051	.066	.325	-.269
240	325	-.330	.074	-.108	-.772	240	385	-.249	.061	-.057	-.530	255	2	-.040	.063	.297	-.274
240	326	-.324	.069	-.151	-.720	240	386	-.271	.067	-.072	-.565	255	3	-.061	.063	.374	-.278
240	327	-.327	.071	-.087	-.758	240	387	-.269	.057	-.018	-.557	255	4	-.094	.075	.228	-.516
240	328	-.325	.068	-.125	-.606	240	388	-.241	.051	-.014	-.440	255	5	-.094	.080	.229	-.431
240	329	-.337	.081	-.105	-.686	240	389	-.231	.043	-.044	-.422	255	6	-.052	.073	.263	-.382
240	330	-.327	.064	-.073	-.583	240	390	-.248	.047	-.123	-.498	255	7	-.020	.081	.309	-.367
240	331	-.300	.084	-.035	-.669	240	391	-.255	.062	-.078	-.631	255	8	-.081	.091	.324	-.482
240	332	-.344	.073	-.099	-.693	240	392	-.267	.064	-.104	-.526	255	9	-.044	.087	.356	-.449
240	333	-.336	.064	-.165	-.727	240	393	-.257	.067	-.078	-.598	255	10	-.015	.090	.423	-.425
240	334	-.333	.069	-.106	-.746	240	394	-.276	.070	-.093	-.644	255	11	-.105	.146	.365	-.805
240	335	-.309	.065	-.064	-.598	240	403	-.469	.142	-.065	-1.198	255	12	-.080	.132	.424	-.549
240	336	-.323	.095	-.017	-.842	240	404	-.447	.125	-.021	-1.046	255	13	-.056	.121	.374	-.436
240	347	-.299	.071	-.080	-.621	240	405	-.455	.113	-.169	-1.107	255	14	-.088	.125	.299	-.805
240	348	-.299	.069	-.066	-.899	240	406	-.434	.097	-.174	-.896	255	15	-.073	.099	.234	-.670
240	349	-.314	.078	-.038	-.889	240	407	-.442	.083	-.177	-.830	255	16	-.009	.129	.456	-.545
240	350	-.322	.095	-.104	-1.212	240	408	-.467	.126	-.138	-1.099	255	17	-.001	.121	.411	-.543
240	351	-.323	.078	-.092	-.964	240	409	-.405	.073	-.211	-.757	255	18	-.076	.085	.247	-.601
240	352	-.340	.079	-.151	-.930	240	410	-.508	.161	-.032	-1.245	255	19	-.159	.025	-.044	-.245
240	353	-.382	.107	-.093	-1.148	240	411	-.494	.141	-.000	-1.184	255	20	-.189	.031	-.051	-.301
240	354	-.402	.117	-.064	-.950	240	412	-.499	.137	-.009	-1.195	255	21	-.158	.024	-.073	-.282
240	355	-.291	.065	-.080	-.605	240	413	-.469	.121	-.153	-1.156	255	22	-.195	.035	-.054	-.310
240	356	-.291	.058	-.102	-.615	240	414	-.447	.117	-.177	-1.252	255	23	-.169	.031	-.007	-.303
240	357	-.381	.079	-.105	-.763	240	415	-.440	.127	-.049	-.977	255	24	-.189	.033	-.074	-.297
240	358	-.416	.106	-.064	-1.096	240	416	-.479	.134	-.092	-1.223	255	25	-.145	.027	-.029	-.218
240	359	-.303	.044	-.158	-.506	240	417	-.541	.143	-.025	-1.177	255	26	-.149	.025	-.031	-.229
240	360	-.314	.040	-.185	-.464	240	418	-.549	.146	-.186	-1.291	255	27	-.145	.034	-.040	-.245
240	361	-.332	.041	-.191	-.528	240	419	-.543	.146	-.195	-1.372	255	28	-.173	.033	-.040	-.264

APPENDIX A -- PRESSURE DATA:

C O L U M B I A P L A Z A , D E N V E R

WD	TAP	CPMEAN	CPRMS	CPMAX	CPMIN	WD	TAP	CPMEAN	CPRMS	CPMAX	CPMIN	WD	TAP	CPMEAN	CPRMS	CPMAX	CPMIN
255	29	-.198	.036	-.073	-.409	255	120	-.604	.276	.325	-1.505	255	170	.086	.088	.454	-.272
255	30	-.184	.034	-.063	-.322	255	121	-.114	.120	.682	-.614	255	171	.039	.082	.343	-.198
255	31	-.215	.039	-.080	-.527	255	122	-.062	.085	.573	-.337	255	172	-.017	.076	.273	-.249
255	32	-.235	.042	-.083	-.585	255	123	-.038	.069	.302	-.284	255	173	-.129	.081	.284	-.406
255	33	-.251	.055	-.069	-.485	255	124	-.025	.083	.271	-.599	255	174	-.445	.098	-.160	-.875
255	34	-.238	.052	-.040	-.517	255	125	-.399	.188	.227	-1.051	255	175	-.121	.068	.098	-.640
255	35	-.183	.033	-.058	-.356	255	126	-.133	.097	.292	-.614	255	176	-.066	.081	.249	-.568
255	36	-.216	.031	-.100	-.364	255	127	-.123	.071	.169	-.551	255	177	-.060	.092	.308	-.329
255	37	-.180	.032	-.016	-.282	255	128	-.134	.064	.130	-.432	255	178	-.026	.089	.302	-.330
255	38	-.265	.054	-.054	-.556	255	129	-.206	.088	.057	-.601	255	179	-.005	.089	.376	-.372
255	39	-.190	.029	-.069	-.294	255	130	-.261	.124	.207	-.737	255	180	-.029	.085	.441	-.345
255	40	-.206	.030	-.103	-.326	255	131	-.123	.064	.067	-.423	255	181	-.103	.086	.292	-.497
255	41	-.209	.053	.022	-.489	255	132	-.241	.115	.286	-.649	255	182	-.338	.072	-.018	-.744
255	42	-.208	.046	.004	-.396	255	133	-.109	.068	.151	-.627	255	183	-.073	.044	.093	-.285
255	43	-.314	.127	-1.204		255	134	-.095	.053	.069	-.469	255	184	-.081	.055	.142	-.297
255	44	-.279	.080	.020	-.750	255	135	-.100	.049	.061	-.393	255	185	-.051	.078	.278	-.388
255	45	-.255	.047	-.116	-.500	255	136	-.100	.054	.078	-.354	255	186	-.169	.060	.103	-.396
255	46	-.273	.057	-.097	-.621	255	137	-.082	.055	.129	-.365	255	187	-.070	.040	.091	-.281
255	47	-.242	.047	-.105	-.534	255	138	-.087	.061	.147	-.670	255	188	-.078	.053	.162	-.267
255	48	-.211	.046	.009	-.462	255	139	-.174	.114	.176	-.755	255	189	-.078	.067	.242	-.290
255	49	-.189	.036	-.056	-.396	255	140	-.037	.065	.265	-.247	255	190	-.053	.076	.270	-.272
255	50	-.231	.054	-.072	-.484	255	141	-.032	.066	.223	-.323	255	191	-.010	.080	.394	-.288
255	51	-.208	.033	-.022	-.347	255	142	-.134	.126	.337	-.802	255	192	-.001	.077	.327	-.238
255	52	-.212	.065	.208	-.433	255	143	-.014	.078	.352	-.241	255	193	-.036	.096	.422	-.413
255	53	-.115	.092	.234	-.754	255	144	-.068	.081	.414	-.286	255	194	-.142	.062	.121	-.352
255	54	-.132	.055	.112	-.351	255	145	-.025	.077	.382	-.269	255	195	-.057	.044	.171	-.317
255	55	-.198	.088	.231	-.445	255	146	-.043	.070	.259	-.404	255	196	-.045	.043	.161	-.179
255	56	-.111	.083	.194	-.487	255	147	-.117	.130	.438	-.475	255	197	-.054	.057	.283	-.336
255	57	-.009	.080	.394	-.331	255	148	.048	.099	.397	-.291	255	198	-.056	.060	.258	-.322
255	58	-.023	.076	.470	-.259	255	149	-.010	.102	.417	-.419	255	199	-.036	.061	.323	-.220
255	59	-.010	.082	.434	-.447	255	150	-.028	.100	.391	-.408	255	200	-.001	.070	.387	-.197
255	101	-.494	.139	-.055	-1.127	255	151	-.077	.095	.254	-.473	255	201	-.025	.056	.293	-.229
255	102	-.601	.139	.061	-1.156	255	152	-.102	.099	.223	-.521	255	202	-.031	.057	.265	-.224
255	103	-.712	.132	-.282	-1.235	255	153	-.162	.101	.205	-.607	255	203	-.917	.249	-.288	-2.041
255	104	-.760	.182	-.265	-1.729	255	154	-.356	.098	.037	-.765	255	204	-.569	.179	-.138	-1.294
255	105	-.706	.135	-.227	-1.459	255	155	.240	.159	.612	-.319	255	205	-.430	.154	.089	-1.116
255	106	-.583	.182	-.162	-1.631	255	156	.208	.122	.620	-.209	255	206	-.335	.111	.005	-.876
255	107	-.344	.147	.082	-1.187	255	157	-.088	.104	.347	-.437	255	207	-.311	.082	-.046	-.691
255	108	-.511	.110	-.145	-1.039	255	158	-.456	.119	.095	-.912	255	208	-.983	.274	-.082	-2.078
255	109	.088	.112	.419	-.354	255	159	.306	.181	.899	-.451	255	209	-.303	.083	-.080	-.773
255	110	-.155	.121	.547	-.257	255	160	.292	.135	.727	-.141	255	210	-.757	.162	-.281	-1.380
255	111	.130	.118	.575	-.260	255	161	.237	.124	.629	-.118	255	211	-.697	.211	-.124	-1.396
255	112	.222	.132	.664	-.256	255	162	.192	.117	.588	-.130	255	212	-.498	.209	-.054	-1.230
255	113	-.508	.124	-.118	-1.134	255	163	.076	.091	.386	-.165	255	213	-.337	.136	.000	-.974
255	114	-.368	.158	.858	-.197	255	164	.000	.080	.371	-.265	255	214	-.318	.086	-.009	-.910
255	115	-.556	.227	.067	-1.715	255	165	-.135	.068	.155	-.360	255	215	-.740	.188	-.323	-1.481
255	116	-.232	.156	.763	-.239	255	166	-.485	.104	-.024	-.853	255	216	-.490	.165	-.111	-1.260
255	117	.325	.159	.786	-.269	255	167	.007	.091	.365	-.462	255	217	-.329	.098	-.055	-.896
255	118	.378	.166	.843	-.132	255	168	.064	.094	.499	-.341	255	218	-.278	.059	-.094	-.616
255	119	.377	.163	.875	-.180	255	169	.080	.095	.422	-.400	255	219	-.272	.058	-.101	-.602

APPENDIX A -- PRESSURE DATA

C O L U M B I A P L A Z A , D E N V E R

WD	TAP	CPMEAN	CPRMS	CPMAX	CPMIN	WD	TAP	CPMEAN	CPRMS	CPMAX	CPMIN	WD	TAP	CPMEAN	CPRMS	CPMAX	CPMIN
255	220	-.569	.137	-.116	-1.076	255	336	-.229	.050	-.056	-.454	255	404	-.530	.178	.005	-1.382
255	221	-.314	.077	-.089	-.649	255	347	-.295	.089	-.047	-.775	255	405	-.588	.187	-.177	-1.568
255	222	-.265	.045	-.112	-.513	255	348	-.300	.093	-.033	-.874	255	406	-.539	.152	-.198	-1.651
255	223	-.244	.037	-.076	-.410	255	349	-.317	.114	.002	-1.395	255	407	-.514	.133	-.189	-1.382
255	224	-.245	.057	-.061	-.866	255	350	-.323	.122	.070	-1.283	255	408	-.536	.198	.116	-1.475
255	225	-.293	.101	-.027	-.702	255	351	-.354	.128	.087	-1.089	255	409	-.468	.132	-.163	-1.331
255	226	-.195	.061	.016	-.541	255	352	-.386	.138	.117	-1.447	255	410	-.486	.200	.107	-1.423
255	227	-.181	.048	.032	-.366	255	353	-.406	.146	.078	-.986	255	411	-.558	.199	-.023	-1.359
255	228	-.231	.051	-.073	-.483	255	354	-.436	.164	.072	-1.225	255	412	-.603	.196	-.018	-1.530
255	229	-.268	.093	.007	-.754	255	355	-.281	.083	-.056	-.761	255	413	-.643	.224	-.067	-1.621
255	230	-.182	.061	.032	-.534	255	356	-.287	.083	-.023	-.909	255	414	-.687	.284	-.125	-2.290
255	231	-.168	.050	.041	-.343	255	357	-.498	.128	.038	-1.048	255	415	-.306	.077	-.030	-.750
255	232	-.198	.053	.066	-.381	255	358	-.457	.156	.051	-1.145	255	416	-.335	.096	.018	-.954
255	233	-.223	.042	.027	-.383	255	359	-.287	.065	-.129	-.595	255	417	-.494	.140	-.085	-1.120
255	234	-.268	.058	-.068	-.559	255	360	-.294	.054	-.115	-.490	255	418	-.525	.204	-.080	-1.435
255	301	-.711	.135	-.279	-1.313	255	361	-.392	.054	-.158	-.575	255	419	-.740	.223	.009	-1.721
255	302	-.554	.142	-.019	-1.098	255	362	-.395	.062	-.110	-.573	255	420	-.310	.066	-.127	-.678
255	303	-.429	.123	-.005	-.986	255	363	-.315	.079	-.087	-.733	255	421	-.293	.070	-.074	-.768
255	304	-.338	.122	.080	-.899	255	364	-.335	.099	.033	-.965	255	422	-.298	.082	-.048	-.800
255	305	-.288	.089	.047	-.624	255	365	-.358	.111	.033	-.757	255	423	-.360	.117	-.046	-1.001
255	306	-.461	.184	.196	-1.185	255	366	-.426	.162	.065	-1.117	255	424	-.485	.152	.102	-1.038
255	307	-.724	.174	-.213	-1.499	255	367	-.292	.078	-.108	-.681	255	425	-.290	.064	-.117	-.600
255	308	-.277	.069	-.030	-.376	255	368	-.286	.060	-.091	-.581	255	426	-.235	.054	-.043	-.570
255	309	-.272	.069	-.019	-.804	255	369	-.294	.062	-.154	-.617	255	427	-.226	.054	-.018	-.625
255	310	-.266	.067	.007	-.739	255	370	-.291	.069	-.126	-.659	255	428	-.305	.108	.034	-.879
255	311	-.261	.065	-.007	-.616	255	371	-.286	.084	-.047	-.881	255	429	-.274	.057	-.048	-.524
255	312	-.276	.071	-.056	-.780	255	372	-.298	.097	-.002	-1.007	255	430	-.227	.052	-.025	-.520
255	313	-.287	.068	-.047	-.700	255	373	-.303	.094	.005	-.993	255	431	-.220	.053	.000	-.528
255	314	-.277	.072	-.042	-.788	255	374	-.304	.095	-.033	-.867	255	432	-.219	.061	-.036	-.499
255	315	-.272	.072	-.035	-.691	255	375	-.298	.079	-.110	-.693	255	433	-.229	.070	-.021	-.522
255	316	-.262	.049	-.084	-.478	255	376	-.295	.066	-.028	-.614	255	434	-.283	.106	.048	-.778
255	317	-.265	.042	-.099	-.449	255	377	-.316	.064	-.107	-.684	255	435	-.180	.052	.039	-.434
255	318	-.255	.040	-.122	-.439	255	378	-.328	.072	-.125	-.632	255	436	-.210	.114	.189	-.781
255	319	-.251	.042	-.075	-.433	255	379	-.326	.084	-.127	-.715	255	437	-.181	.048	.011	-.359
255	320	-.259	.051	-.103	-.475	255	380	-.330	.080	-.143	-.775	255	438	-.140	.056	.071	-.388
255	321	-.258	.049	-.078	-.613	255	381	-.318	.080	-.046	-.759	255	439	-.148	.064	.092	-.431
255	322	-.254	.049	-.089	-.524	255	382	-.324	.075	-.152	-.676	255	440	-.158	.084	.141	-.569
255	323	-.243	.045	-.028	-.499	255	383	-.261	.075	-.064	-.792	255	441	-.212	.126	.126	-.805
255	324	-.254	.049	-.063	-.548	255	384	-.262	.050	-.078	-.476	270	1	-.020	.075	.327	-.259
255	325	-.259	.052	-.059	-.511	255	385	-.317	.083	-.082	-.789	270	2	-.007	.073	.310	-.243
255	326	-.262	.055	-.126	-.526	255	386	-.351	.103	-.106	-.925	270	3	-.025	.072	.356	-.263
255	327	-.255	.053	-.089	-.496	255	387	-.269	.087	-.077	-.842	270	4	-.052	.080	.292	-.459
255	328	-.248	.047	-.082	-.459	255	388	-.253	.050	-.069	-.621	270	5	-.063	.090	.338	-.573
255	329	-.264	.048	-.059	-.511	255	389	-.255	.055	.005	-.566	270	6	-.007	.081	.379	-.569
255	330	-.254	.057	-.103	-.584	255	390	-.267	.057	-.078	-.598	270	7	-.036	.099	.568	-.420
255	331	-.227	.050	-.080	-.468	255	391	-.281	.062	-.080	-.539	270	8	-.034	.120	.447	-.625
255	332	-.264	.065	-.108	-.649	255	392	-.292	.069	-.016	-.586	270	9	.054	.133	.639	-.336
255	333	-.267	.057	-.114	-.657	255	393	-.303	.088	.009	-.700	270	10	.091	.114	.600	-.263
255	334	-.253	.061	-.082	-.727	255	394	-.344	.107	-.090	-.916	270	11	-.042	.166	.696	-.944
255	335	-.221	.051	-.042	-.532	255	403	-.526	.191	.099	-1.387	270	12	-.061	.128	.372	-.512

WD	TAP	CPMEAN	CPRMS	CPMAX	CPMIN	WD	TAP	CPMEAN	CPRMS	CPMAX	CPMIN	WD	TAP	CPMEAN	CPRMS	CPMAX	CPMIN
270	13	-.058	.140	.382	-.489	270	104	-.821	.154	-.320	-1.403	270	154	-.272	.072	.016	-.624
270	14	-.073	.168	.431	-.902	270	105	-.770	.151	-.382	-1.438	270	155	-.125	.163	.434	-.660
270	15	-.060	.139	.281	-.791	270	106	-.518	.129	-.117	-1.254	270	156	-.092	.081	.422	-.169
270	16	-.006	.139	.565	-.611	270	107	-.335	.121	.081	-.920	270	157	-.087	.063	.182	-.266
270	17	-.008	.113	.424	-.628	270	108	-.456	.141	.027	-.961	270	158	-.295	.091	-.025	-.741
270	18	-.056	.098	.279	-.737	270	109	-.162	.122	.562	-.203	270	159	-.001	.220	.651	-.771
270	19	-.150	.035	-.004	-.292	270	110	.190	.123	.552	-.225	270	160	.194	.102	.557	-.336
270	20	-.182	.043	-.018	-.359	270	111	.142	.114	.513	-.278	270	161	.152	.093	.519	-.123
270	21	-.157	.032	-.051	-.294	270	112	.150	.115	.555	-.253	270	162	.133	.091	.554	-.122
270	22	-.202	.044	-.029	-.417	270	113	-.516	.168	.039	-1.197	270	163	.064	.080	.414	-.174
270	23	-.151	.037	.011	-.347	270	114	.316	.131	.689	-.106	270	164	.006	.079	.345	-.248
270	24	-.188	.041	-.044	-.408	270	115	-.537	.215	.287	-1.411	270	165	-.097	.073	.193	-.371
270	25	-.134	.035	.013	-.290	270	116	.437	.151	.920	-.900	270	166	-.364	.108	-.072	-.838
270	26	-.139	.031	.033	-.254	270	117	.462	.160	.980	.057	270	167	-.240	.170	.242	-.812
270	27	-.126	.043	.084	-.351	270	118	.428	.144	.881	.050	270	168	-.138	.180	.350	-.979
270	28	-.172	.046	-.016	-.385	270	119	.271	.131	.699	-.104	270	169	-.042	.104	.451	-.589
270	29	-.192	.042	-.035	-.360	270	120	-.241	.214	.426	-.388	270	170	-.010	.086	.378	-.333
270	30	-.177	.043	.000	-.391	270	121	.160	.203	.837	-.382	270	171	-.001	.095	.371	-.298
270	31	-.199	.043	-.042	-.586	270	122	.094	.156	.736	-.313	270	172	-.024	.099	.368	-.379
270	32	-.216	.042	-.031	-.463	270	123	.010	.101	.448	-.260	270	173	-.110	.106	.330	-.510
270	33	-.270	.062	-.084	-.566	270	124	-.100	.077	.214	-.356	270	174	-.382	.118	.023	-.842
270	34	-.253	.057	-.069	-.525	270	125	-.179	.157	.323	-.815	270	175	-.156	.101	.228	-.837
270	35	-.170	.040	-.015	-.393	270	126	.002	.162	.712	-.484	270	176	-.135	.096	.156	-.627
270	36	-.187	.036	-.058	-.350	270	127	-.064	.120	.488	-.581	270	177	-.126	.090	.181	-.475
270	37	-.171	.039	-.038	-.391	270	128	-.107	.081	.345	-.446	270	178	-.081	.083	.283	-.518
270	38	-.258	.051	-.076	-.520	270	129	-.125	.072	.205	-.460	270	179	-.051	.098	.332	-.399
270	39	-.167	.036	-.011	-.301	270	130	-.210	.089	.131	-.651	270	180	-.078	.109	.428	-.441
270	40	-.180	.035	-.040	-.301	270	131	-.120	.069	.093	-.506	270	181	-.142	.120	.439	-.609
270	41	-.211	.049	.031	-.433	270	132	-.211	.087	.129	-.625	270	182	-.333	.101	.045	-.742
270	42	-.198	.044	-.002	-.350	270	133	-.186	.069	.166	-.649	270	183	-.084	.055	.126	-.334
270	43	-.349	.119	-.051	-.860	270	134	-.168	.065	.128	-.633	270	184	-.086	.060	.258	-.441
270	44	-.279	.087	-.078	-.696	270	135	-.141	.060	.084	-.504	270	185	.007	.094	.342	-.326
270	45	-.239	.051	-.062	-.511	270	136	-.121	.070	.180	-.462	270	186	-.111	.070	.158	-.369
270	46	-.258	.064	-.027	-.558	270	137	-.130	.065	.130	-.539	270	187	-.082	.053	.094	-.312
270	47	-.226	.047	-.102	-.457	270	138	-.122	.078	.128	-.493	270	188	-.080	.054	.106	-.387
270	48	-.246	.087	-.024	-.977	270	139	-.228	.090	.181	-.746	270	189	-.066	.064	.199	-.337
270	49	-.164	.041	.000	-.382	270	140	-.096	.073	.230	-.419	270	190	-.032	.071	.274	-.459
270	50	-.268	.076	-.067	-.690	270	141	-.089	.082	.182	-.567	270	191	.031	.086	.381	-.312
270	51	-.186	.053	.046	-.382	270	142	-.220	.088	.115	-.610	270	192	.057	.096	.428	-.265
270	52	-.141	.102	.354	-.527	270	143	-.133	.061	.158	-.359	270	193	.045	.129	.548	-.471
270	53	-.063	.106	.491	-.471	270	144	-.101	.068	.250	-.345	270	194	-.071	.089	.344	-.400
270	54	-.071	.082	.288	-.424	270	145	-.084	.076	.294	-.360	270	195	-.085	.045	.111	-.281
270	55	-.058	.076	.338	-.400	270	146	-.094	.091	.239	-.534	270	196	-.042	.044	.155	-.224
270	56	-.056	.084	.348	-.337	270	147	-.205	.165	.255	-.775	270	197	-.031	.056	.181	-.204
270	57	-.079	.133	.902	-.312	270	148	-.064	.077	.246	-.338	270	198	-.020	.067	.240	-.348
270	58	.049	.119	.788	-.208	270	149	-.094	.076	.243	-.382	270	199	.006	.070	.294	-.237
270	59	.091	.142	.767	-.376	270	150	-.095	.071	.218	-.345	270	200	.061	.090	.455	-.204
270	101	-.430	.112	-.036	-.837	270	151	-.125	.060	.088	-.310	270	201	-.014	.057	.238	-.215
270	102	-.478	.161	-.054	-1.076	270	152	-.125	.061	.187	-.338	270	202	.001	.072	.410	-.190
270	103	-.793	.142	-.359	-1.309	270	153	-.165	.060	.068	-.396	270	203	-.521	.188	-.165	-1.307

APPENDIX A -- PRESSURE DATA

C O L U M B I A P L A Z A , D E N V E R

WD	TAP	CPMEAN	CPRMS	CPMAX	CPMIN	WD	TAP	CPMEAN	CPRMS	CPMAX	CPMIN	WD	TAP	CPMEAN	CPRMS	CPMAX	CPMIN
270	204	-.484	.154	-.110	-1.177	270	320	-.283	.095	-.144	-.773	270	380	-.334	.085	-.100	-.741
270	205	-.454	.140	-.086	-1.242	270	321	-.284	.073	-.037	-.701	270	381	-.329	.084	-.049	-.685
270	206	-.404	.137	.038	-1.079	270	322	-.273	.063	-.053	-.683	270	382	-.316	.080	-.116	-.654
270	207	-.368	.128	.018	-1.198	270	323	-.256	.055	-.074	-.513	270	383	-.252	.075	-.036	-.616
270	208	-.493	.209	-.186	-1.735	270	324	-.270	.058	-.107	-.599	270	384	-.244	.055	-.057	-.612
270	209	-.366	.127	.000	-1.056	270	325	-.272	.090	-.005	-.802	270	385	-.308	.089	-.040	-.719
270	210	-.532	.178	-.177	-1.269	270	326	-.268	.082	-.058	-.734	270	386	-.337	.115	-.102	-1.001
270	211	-.516	.170	-.095	-1.343	270	327	-.257	.070	-.088	-.610	270	387	-.257	.088	-.041	-.835
270	212	-.477	.167	-.049	-1.262	270	328	-.255	.057	.009	-.497	270	388	-.243	.056	-.079	-.501
270	213	-.424	.142	.025	-1.161	270	329	-.268	.059	-.077	-.505	270	389	-.249	.062	-.061	-.689
270	214	-.417	.154	.034	-1.134	270	330	-.234	.070	-.035	-.665	270	390	-.263	.064	-.057	-.751
270	215	-.701	.178	-.208	-1.501	270	331	-.209	.052	.000	-.504	270	391	-.281	.071	-.054	-.601
270	216	-.485	.185	.004	-1.213	270	332	-.245	.077	-.023	-.780	270	392	-.294	.078	-.079	-.791
270	217	-.361	.159	.090	-1.389	270	333	-.242	.067	-.082	-.713	270	393	-.306	.090	-.054	-.736
270	218	-.309	.120	.020	-.937	270	334	-.229	.066	-.060	-.598	270	394	-.328	.101	-.079	-.888
270	219	-.300	.091	-.077	-.789	270	335	-.203	.051	-.030	-.543	270	403	-.370	.150	.175	-1.067
270	220	-.501	.155	-.087	-1.148	270	336	-.217	.051	-.014	-.522	270	404	-.504	.181	.056	-1.273
270	221	-.310	.107	-.025	-1.043	270	347	-.258	.079	-.028	-.740	270	405	-.730	.172	-.177	-1.371
270	222	-.263	.069	-.070	-.785	270	348	-.260	.085	.021	-.991	270	406	-.793	.173	-.265	-1.390
270	223	-.240	.052	-.066	-.579	270	349	-.265	.096	.112	-1.022	270	407	-.833	.216	-.247	-1.702
270	224	-.254	.082	-.052	-.845	270	350	-.265	.107	.076	-.877	270	408	-.367	.148	.056	-1.032
270	225	-.250	.111	.127	-.882	270	351	-.269	.113	.125	-.779	270	409	-.828	.238	-.242	-1.656
270	226	-.147	.079	.165	-.507	270	352	-.285	.128	.111	-1.330	270	410	-.325	.119	.029	-.995
270	227	-.130	.072	.156	-.360	270	353	-.303	.128	.138	-1.197	270	411	-.456	.171	.095	-1.083
270	228	-.225	.071	-.031	-.724	270	354	-.332	.124	.099	-.981	270	412	-.627	.211	-.129	-1.461
270	229	-.228	.112	.156	-.928	270	355	-.247	.077	-.037	-.751	270	413	-.857	.245	-.233	-1.887
270	230	-.125	.085	.217	-.582	270	356	-.247	.079	.012	-1.000	270	414	-1.018	.305	-.254	-2.259
270	231	-.102	.081	.219	-.366	270	357	-.304	.120	.068	-.809	270	415	-.278	.051	-.116	-.465
270	232	-.134	.084	.202	-.475	270	358	-.333	.129	.192	-.993	270	416	-.290	.051	-.113	-.501
270	233	-.178	.073	.161	-.380	270	359	-.255	.061	-.092	-.606	270	417	-.322	.055	-.156	-.671
270	234	-.263	.087	-.068	-.853	270	360	-.259	.053	-.102	-.504	270	418	-.380	.093	-.148	-1.114
270	301	-.802	.138	-.241	-1.349	270	361	-.266	.048	-.122	-.468	270	419	-.761	.265	-.143	-1.991
270	302	-.452	.164	.007	-1.016	270	362	-.259	.050	-.108	-.476	270	420	-.296	.069	-.099	-.569
270	303	-.395	.115	.028	-.802	270	363	-.245	.055	-.037	-.499	270	421	-.273	.057	-.097	-.514
270	304	-.357	.109	.021	-.789	270	364	-.252	.064	.033	-.573	270	422	-.265	.059	-.067	-.557
270	305	-.212	.077	.047	-.538	270	365	-.265	.068	-.016	-.620	270	423	-.296	.074	-.073	-.720
270	306	-.357	.155	.164	-1.048	270	366	-.280	.091	.030	-1.076	270	424	-.535	.228	.020	-1.398
270	307	-.831	.147	-.388	-1.627	270	367	-.281	.074	-.083	-.645	270	425	-.291	.069	-.088	-.607
270	308	-.350	.118	.002	-.880	270	368	-.218	.060	-.121	-.534	270	426	-.241	.055	-.040	-.483
270	309	-.292	.078	-.023	-.610	270	369	-.287	.059	-.145	-.622	270	427	-.231	.053	-.041	-.465
270	310	-.265	.069	-.055	-.566	270	370	-.278	.059	-.136	-.635	270	428	-.253	.099	.063	-.831
270	311	-.239	.060	-.035	-.497	270	371	-.259	.058	-.076	-.541	270	429	-.278	.063	-.113	-.553
270	312	-.259	.070	.035	-.541	270	372	-.266	.059	-.065	-.610	270	430	-.234	.052	-.088	-.433
270	313	-.356	.122	.012	-.907	270	373	-.266	.055	-.058	-.636	270	431	-.227	.052	-.070	-.452
270	314	-.262	.077	-.039	-.623	270	374	-.254	.053	-.058	-.563	270	432	-.225	.056	-.043	-.488
270	315	-.366	.157	.042	-1.070	270	375	-.293	.082	-.025	-.666	270	433	-.232	.060	-.014	-.496
270	316	-.286	.069	-.100	-.608	270	376	-.295	.067	-.142	-.652	270	434	-.250	.089	.101	-.860
270	317	-.264	.050	-.065	-.510	270	377	-.320	.073	-.106	-.653	270	435	-.196	.050	.016	-.406
270	318	-.246	.045	-.099	-.436	270	378	-.333	.079	-.125	-.706	270	436	-.236	.083	.262	-.578
270	319	-.240	.048	-.079	-.492	270	379	-.340	.090	-.122	-.754	270	437	-.198	.048	-.016	-.410

WD	TAP	CPMEAN	CPRMS	CPMAX	CPMIN	WD	TAP	CPMEAN	CPRMS	CPMAX	CPMIN	WD	TAP	CPMEAN	CPRMS	CPMAX	CPMIN
270	438	-.176	.055	.016	-.501	285	47	-.211	.041	-.098	-.422	285	138	-.142	.057	.071	-.371
270	439	-.197	.063	.027	-.529	285	48	-.226	.061	-.053	-.617	285	139	-.210	.058	.080	-.560
270	440	-.211	.075	.041	-.641	285	49	-.172	.042	-.006	-.508	285	140	-.093	.062	.194	-.323
270	441	-.233	.094	.127	-.730	285	50	-.207	.045	-.093	-.445	285	141	-.096	.065	.099	-.337
285	1	-.061	.046	.103	-.275	285	51	-.188	.044	.102	-.396	285	142	-.214	.063	.080	-.503
285	2	-.046	.046	.123	-.227	285	52	-.215	.084	.173	-.459	285	143	-.112	.058	.203	-.277
285	3	-.065	.041	.083	-.211	285	53	-.051	.074	.359	-.322	285	144	-.079	.067	.198	-.311
285	4	-.093	.057	.090	-.386	285	54	-.087	.060	.315	-.352	285	145	-.100	.064	.182	-.373
285	5	-.075	.054	.179	-.278	285	55	-.052	.070	.309	-.304	285	146	-.119	.067	.116	-.460
285	6	-.043	.053	.177	-.229	285	56	-.075	.067	.198	-.352	285	147	-.416	.129	-.018	-.935
285	7	-.000	.056	.230	-.205	285	57	-.017	.063	.359	-.184	285	148	-.125	.066	.067	-.436
285	8	-.038	.060	.286	-.406	285	58	-.030	.052	.358	-.164	285	149	-.143	.064	.056	-.542
285	9	-.018	.067	.329	-.256	285	59	-.004	.073	.379	-.238	285	150	-.134	.059	.142	-.447
285	10	.007	.065	.330	-.207	285	101	-.275	.094	-.043	-.740	285	151	-.137	.049	.063	-.348
285	11	-.009	.084	.368	-.539	285	102	-.262	.112	.031	-.858	285	152	-.138	.048	.062	-.334
285	12	-.008	.093	.378	-.440	285	103	-.663	.159	-.138	-1.342	285	153	-.161	.049	.029	-.380
285	13	.006	.082	.346	-.350	285	104	-.938	.181	-.196	-1.764	285	154	-.221	.052	-.056	-.523
285	14	-.024	.066	.302	-.378	285	105	-.723	.151	-.256	-1.446	285	155	-.357	.137	.121	-.766
285	15	-.029	.056	.209	-.304	285	106	-.384	.090	-.125	-.994	285	156	.000	.071	.274	-.289
285	16	.024	.082	.337	-.263	285	107	-.225	.078	.025	-.679	285	157	-.113	.049	.097	-.304
285	17	-.006	.094	.369	-.342	285	108	-.256	.243	.583	-1.413	285	158	-.235	.063	-.062	-.627
285	18	-.070	.052	.160	-.274	285	109	.193	.164	.677	-.421	285	159	-.255	.166	.444	-.804
285	19	-.174	.030	-.075	-.362	285	110	.203	.151	.736	-.334	285	160	.058	.089	.396	-.334
285	20	-.183	.029	-.088	-.337	285	111	.150	.128	.598	-.330	285	161	.064	.071	.367	-.157
285	21	-.178	.029	-.083	-.297	285	112	.094	.109	.516	-.311	285	162	.063	.068	.356	-.140
285	22	-.204	.033	-.089	-.339	285	113	-.368	.268	.488	-1.626	285	163	.025	.060	.279	-.156
285	23	-.165	.029	-.049	-.270	285	114	.213	.137	.743	-.325	285	164	-.018	.061	.245	-.227
285	24	-.192	.031	-.094	-.322	285	115	-.613	.228	.270	-1.438	285	165	-.105	.062	.189	-.349
285	25	-.142	.033	.004	-.286	285	116	.376	.150	.841	-.051	285	166	-.294	.084	-.064	-.654
285	26	-.153	.030	-.030	-.246	285	117	.407	.150	1.003	-.029	285	167	-.398	.131	.150	-1.029
285	27	-.122	.042	.177	-.230	285	118	.371	.146	.894	-.029	285	168	-.242	.142	.238	-.863
285	28	-.154	.033	.019	-.307	285	119	.158	.116	.536	-.192	285	169	-.083	.075	.286	-.598
285	29	-.193	.036	-.038	-.374	285	120	-.439	.196	.136	-1.257	285	170	-.044	.056	.291	-.380
285	30	-.186	.033	-.043	-.337	285	121	.217	.139	.785	-.175	285	171	-.039	.065	.397	-.219
285	31	-.187	.037	-.049	-.373	285	122	.207	.136	.765	-.176	285	172	-.063	.074	.354	-.280
285	32	-.202	.038	-.077	-.425	285	123	.112	.110	.665	-.208	285	173	-.140	.093	.358	-.553
285	33	-.260	.049	-.070	-.476	285	124	-.086	.058	.131	-.338	285	174	-.366	.116	.000	-.903
285	34	-.242	.047	-.071	-.443	285	125	-.342	.152	.101	-1.080	285	175	-.173	.100	.118	-.612
285	35	-.175	.029	-.075	-.307	285	126	.004	.114	.529	-.320	285	176	-.139	.081	.125	-.550
285	36	-.180	.031	-.053	-.282	285	127	-.025	.107	.438	-.324	285	177	-.140	.074	.143	-.745
285	37	-.181	.030	-.081	-.459	285	128	-.067	.084	.256	-.307	285	178	-.110	.068	.131	-.439
285	38	-.255	.046	-.093	-.425	285	129	-.112	.055	.094	-.286	285	179	-.076	.072	.224	-.351
285	39	-.170	.028	-.051	-.328	285	130	-.239	.067	.094	-.567	285	180	-.097	.062	.252	-.337
285	40	-.177	.030	-.053	-.271	285	131	-.129	.074	.100	-.493	285	181	-.152	.067	.248	-.382
285	41	-.215	.039	-.098	-.344	285	132	-.229	.061	.029	-.494	285	182	-.316	.083	-.067	-.779
285	42	-.203	.036	-.086	-.319	285	133	-.202	.046	.027	-.403	285	183	-.074	.057	.138	-.530
285	43	-.355	.112	-.057	-.839	285	134	-.169	.043	-.013	-.365	285	184	-.083	.043	.087	-.248
285	44	-.271	.076	-.064	-.645	285	135	-.135	.050	.038	-.493	285	185	-.033	.070	.317	-.295
285	45	-.223	.042	-.096	-.442	285	136	-.132	.068	.098	-.396	285	186	-.112	.059	.616	-.289
285	46	-.243	.052	-.089	-.516	285	137	-.138	.051	.049	-.364	285	187	-.079	.048	.136	-.375

APPENDIX A -- PRESSURE DATA:

C O L U M B I A P L A Z A , D E N V E R

WD	TAP	CPMEAN	CPRMS	CPMAX	CPMIN	WD	TAP	CPMEAN	CPRMS	CPMAX	CPMIN	WD	TAP	CPMEAN	CPRMS	CPMAX	CPMIN
285	188	-.075	.042	.093	-.274	285	304	-.231	.081	-.022	-.577	285	364	-.350	.066	-.158	-.633
285	189	-.065	.050	.175	-.298	285	305	-.189	.049	-.016	-.384	285	365	-.369	.068	-.192	-.671
285	189	-.032	.059	.220	-.272	285	306	-.190	.076	.007	-.626	285	366	-.368	.074	-.189	-.945
285	191	.015	.069	.293	-.292	285	307	-.056	.192	.029	-1.372	285	367	-.322	.079	-.055	-.644
285	192	.009	.067	.333	-.180	285	308	-.256	.078	-.053	-.657	285	368	-.348	.077	-.040	-.666
285	193	-.022	.080	.369	-.282	285	309	-.239	.057	-.065	-.629	285	369	-.384	.074	-.134	-.665
285	194	-.088	.067	.309	-.311	285	310	-.238	.057	-.037	-.533	285	370	-.402	.075	-.165	-.714
285	195	-.092	.039	.074	-.352	285	311	-.241	.061	-.064	-.615	285	371	-.418	.088	-.198	-.805
285	196	-.058	.034	.108	-.170	285	312	-.274	.074	-.022	-.679	285	372	-.427	.090	-.175	-.812
285	197	-.051	.045	.220	-.176	285	313	-.274	.079	-.083	-.756	285	373	-.432	.090	-.194	-.821
285	198	-.045	.049	.182	-.215	285	314	-.281	.077	-.048	-.637	285	374	-.415	.087	-.183	-.835
285	199	-.027	.048	.161	-.170	285	315	-.361	.127	.095	-1.083	285	375	-.204	.057	-.062	-.554
285	200	.005	.055	.267	-.144	285	316	-.297	.059	-.089	-.673	285	376	-.214	.057	-.060	-.575
285	201	-.057	.035	.083	-.215	285	317	-.303	.050	-.105	-.460	285	377	-.256	.078	-.078	-.668
285	202	-.044	.042	.150	-.163	285	318	-.311	.056	-.095	-.505	285	378	-.283	.093	-.072	-.684
285	203	-.305	.087	-.107	-.918	285	319	-.324	.059	-.139	-.593	285	379	-.390	.128	-.041	-.954
285	204	-.298	.085	-.108	-.929	285	320	-.326	.139	.018	-1.025	285	380	-.464	.130	-.127	-.945
285	205	-.304	.084	-.089	-.913	285	321	-.274	.073	-.033	-.701	285	381	-.501	.129	-.122	-1.127
285	206	-.298	.083	-.039	-.906	285	322	-.274	.061	-.029	-.516	285	382	-.486	.110	-.241	-.921
285	207	-.283	.088	-.024	-.692	285	323	-.281	.060	-.108	-.648	285	383	-.201	.042	-.063	-.456
285	208	-.291	.086	-.121	-1.060	285	324	-.308	.061	-.115	-.557	285	384	-.208	.037	-.070	-.364
285	209	-.291	.089	-.063	-.863	285	325	-.227	.073	-.029	-.817	285	385	-.281	.074	-.104	-.666
285	210	-.359	.100	-.113	-.917	285	326	-.205	.052	-.046	-.533	285	386	-.376	.134	-.136	-1.052
285	211	-.352	.102	-.102	-.959	285	327	-.204	.044	-.073	-.454	285	387	-.210	.056	-.009	-.517
285	212	-.362	.116	-.004	-1.000	285	328	-.222	.040	-.084	-.526	285	388	-.207	.035	-.107	-.355
285	213	-.397	.119	.026	-1.285	285	329	-.233	.048	-.087	-.435	285	389	-.203	.038	-.096	-.422
285	214	-.427	.149	-.037	-1.345	285	330	-.184	.040	-.064	-.438	285	390	-.210	.040	-.090	-.419
285	215	-.540	.150	-.117	-1.240	285	331	-.183	.033	-.095	-.393	285	391	-.228	.048	-.081	-.530
285	216	-.486	.160	-.043	-1.498	285	332	-.187	.044	-.051	-.468	285	392	-.247	.056	-.083	-.522
285	217	-.439	.175	.191	-1.276	285	333	-.185	.034	-.067	-.484	285	393	-.267	.069	-.089	-.635
285	218	-.386	.164	.130	-1.084	285	334	-.180	.029	-.079	-.306	285	394	-.329	.103	-.094	-.958
285	219	-.351	.150	.004	-1.155	285	335	-.176	.029	-.084	-.375	285	403	-.281	.051	-.086	-.491
285	220	-.436	.141	-.086	-1.196	285	336	-.194	.034	-.073	-.360	285	404	-.258	.057	-.015	-.546
285	221	-.329	.121	.000	-1.089	285	347	-.322	.109	-.007	-.783	285	405	-.316	.076	.064	-1.024
285	222	-.272	.093	.000	-1.158	285	348	-.326	.105	-.069	-.972	285	406	-.462	.159	.050	-1.149
285	223	-.231	.073	-.020	-1.053	285	349	-.343	.111	-.056	-1.138	285	407	-1.056	.282	.335	-1.857
285	224	-.224	.075	-.009	-.901	285	350	-.338	.105	-.053	-.868	285	408	-.281	.047	-.120	-.445
285	225	-.210	.086	.161	-.596	285	351	-.320	.077	-.117	-.710	285	409	-1.137	.308	.175	-2.032
285	226	-.141	.059	.093	-.489	285	352	-.328	.075	-.109	-.732	285	410	-.341	.060	-.094	-.598
285	227	-.142	.061	.122	-.320	285	353	-.320	.071	-.138	-.611	285	411	-.338	.075	-.149	-.906
285	228	-.182	.044	-.043	-.401	285	354	-.311	.067	-.143	-.628	285	412	-.422	.151	-.151	-1.244
285	229	-.197	.084	.093	-.585	285	355	-.319	.110	-.002	-.763	285	413	-.688	.270	-.123	-1.661
285	230	-.128	.070	.272	-.354	285	356	-.319	.102	-.060	-.868	285	414	-1.088	.290	-.115	-2.193
285	231	-.124	.077	.302	-.342	285	357	-.326	.069	-.156	-.678	285	415	-.383	.065	-.182	-.660
285	232	-.162	.084	.302	-.403	285	358	-.318	.065	-.150	-.676	285	416	-.338	.054	-.142	-.589
285	233	-.187	.059	.133	-.411	285	359	-.348	.066	-.161	-.604	285	417	-.354	.060	-.175	-.888
285	234	-.206	.051	-.080	-.606	285	360	-.349	.063	-.162	-.639	285	418	-.441	.144	-.183	-1.403
285	301	-.570	.171	-.029	-1.178	285	361	-.354	.060	-.185	-.584	285	419	-.991	.296	-.241	-1.960
285	302	-.223	.094	.013	-.800	285	362	-.350	.063	-.183	-.562	285	420	-.396	.075	-.194	-.751
285	303	-.215	.075	-.037	-.562	285	363	-.339	.062	-.176	-.618	285	421	-.321	.050	-.169	-.513

WD	TAP	CPMEAN	CPRMS	CPHAX	CPMIN	WD	TAP	CPMEAN	CPRMS	CPHAX	CPMIN	WD	TAP	CPMEAN	CPRMS	CPHAX	CPMIN
285	422	-.300	.050	-.133	-.518	300	31	-.174	.032	.039	-.278	300	122	.054	.082	.478	-.190
285	423	-.343	.079	-.147	-.829	300	32	-.190	.025	-.079	-.330	300	123	.017	.071	.325	-.204
285	424	-.656	.213	-.079	-1.910	300	33	-.216	.027	-.135	-.319	300	124	-.076	.047	.096	-.234
285	425	-.290	.070	-.103	-.581	300	34	-.230	.030	-.129	-.351	300	125	-.233	.101	.129	-.688
285	426	-.235	.047	-.074	-.452	300	35	-.125	.058	.180	-.289	300	126	-.029	.064	.282	-.259
285	427	-.227	.043	-.103	-.423	300	36	-.177	.025	-.079	-.273	300	127	-.032	.060	.200	-.235
285	428	-.278	.087	-.028	-.744	300	37	-.223	.043	-.063	-.376	300	128	-.044	.054	.207	-.225
285	429	-.269	.057	-.090	-.541	300	38	-.147	.043	.076	-.327	300	129	-.097	.037	.077	-.239
285	430	-.227	.044	-.094	-.405	300	39	-.159	.030	-.033	-.312	300	130	-.185	.065	.121	-.483
285	431	-.221	.042	-.088	-.408	300	40	-.174	.023	-.083	-.273	300	131	-.102	.034	.027	-.312
285	432	-.223	.045	-.072	-.393	300	41	-.209	.026	-.111	-.306	300	132	-.165	.061	.107	-.436
285	433	-.230	.044	-.083	-.414	300	42	-.230	.029	-.118	-.340	300	133	-.128	.048	.194	-.262
285	434	-.262	.078	-.044	-.674	300	43	-.302	.067	-.148	-.822	300	134	-.122	.039	.094	-.239
285	435	-.196	.037	-.059	-.335	300	44	-.246	.042	-.146	-.466	300	135	-.113	.032	.087	-.258
285	436	-.218	.054	.028	-.496	300	45	-.212	.030	-.119	-.335	300	136	-.094	.039	.085	-.285
285	437	-.202	.037	-.055	-.384	300	46	-.190	.025	-.115	-.355	300	137	-.115	.028	-.027	-.225
285	438	-.179	.040	-.002	-.376	300	47	-.186	.022	-.093	-.293	300	138	-.110	.034	.007	-.244
285	439	-.197	.045	.007	-.421	300	48	-.228	.038	-.138	-.407	300	139	-.175	.046	.063	-.356
285	440	-.204	.052	.026	-.520	300	49	-.195	.029	-.115	-.356	300	140	-.076	.037	.045	-.245
285	441	-.218	.056	.002	-.480	300	50	-.157	.036	-.024	-.355	300	141	-.069	.034	.038	-.250
300	1	-.106	.030	.009	-.222	300	51	-.172	.026	-.076	-.269	300	142	-.176	.048	.047	-.393
300	2	-.100	.030	.013	-.244	300	52	-.206	.044	-.026	-.380	300	143	-.097	.038	.067	-.229
300	3	-.099	.031	.037	-.217	300	53	-.141	.025	-.033	-.252	300	144	-.072	.040	.134	-.203
300	4	-.111	.035	.024	-.302	300	54	-.104	.036	.033	-.279	300	145	-.083	.037	.079	-.223
300	5	-.094	.032	.059	-.241	300	55	-.103	.038	.033	-.310	300	146	-.087	.035	.036	-.273
300	6	-.097	.041	.039	-.329	300	56	-.111	.042	.013	-.378	300	147	-.431	.152	.061	-1.069
300	7	-.075	.036	.128	-.243	300	57	-.090	.031	.104	-.206	300	148	-.178	.094	.154	-.788
300	8	-.092	.036	.094	-.249	300	58	-.079	.033	.146	-.187	300	149	-.157	.077	.126	-.458
300	9	-.082	.038	.130	-.193	300	59	-.081	.038	.317	-.228	300	150	-.138	.069	.143	-.366
300	10	-.080	.039	.135	-.242	300	101	-.179	.060	-.032	-.564	300	151	-.140	.055	.093	-.354
300	11	-.083	.045	.132	-.247	300	102	-.187	.064	.004	-.619	300	152	-.130	.055	.073	-.323
300	12	-.074	.055	.162	-.254	300	103	-.299	.126	-.016	-.912	300	153	-.155	.051	.036	-.361
300	13	-.089	.040	.080	-.276	300	104	-.348	.213	.116	-1.485	300	154	-.186	.050	-.016	-.451
300	14	-.076	.056	.205	-.233	300	105	-.481	.157	-.038	-1.220	300	155	-.389	.138	.002	-.847
300	15	-.089	.039	.106	-.228	300	106	-.243	.094	.047	-1.012	300	156	-.139	.111	.160	-.832
300	16	-.077	.061	.251	-.317	300	107	-.137	.062	.074	-.401	300	157	-.137	.048	.047	-.318
300	17	-.119	.038	.070	-.282	300	108	.021	.279	.930	-.928	300	158	-.201	.049	-.060	-.563
300	18	-.107	.051	.242	-.314	300	109	.061	.165	.649	-.365	300	159	-.285	.151	.300	-.968
300	19	-.159	.026	-.069	-.347	300	110	.048	.151	.697	-.362	300	160	-.082	.110	.280	-.799
300	20	-.180	.023	-.103	-.330	300	111	.007	.135	.558	-.332	300	161	-.062	.065	.158	-.408
300	21	-.214	.035	-.096	-.393	300	112	-.055	.116	.358	-.418	300	162	-.052	.057	.172	-.237
300	22	-.156	.020	-.068	-.220	300	113	.003	.304	.940	-1.488	300	163	-.067	.051	.146	-.226
300	23	-.165	.022	-.087	-.239	300	114	-.022	.133	.561	-.458	300	164	-.080	.052	.160	-.247
300	24	-.205	.042	-.066	-.448	300	115	-.246	.222	.554	-1.143	300	165	-.127	.051	.113	-.336
300	25	-.165	.019	-.102	-.232	300	116	.140	.105	.541	-.251	300	166	-.221	.058	-.049	-.485
300	26	-.161	.019	-.102	-.235	300	117	.134	.110	.602	-.169	300	167	-.266	.084	-.022	-.715
300	27	-.163	.022	-.076	-.243	300	118	.106	.111	.603	-.183	300	168	-.155	.071	.096	-.601
300	28	-.180	.030	-.074	-.293	300	119	-.026	.108	.379	-.392	300	169	-.111	.045	.065	-.325
300	29	-.195	.049	.011	-.545	300	120	-.254	.146	.231	-.899	300	170	-.092	.038	.107	-.226
300	30	-.149	.053	.176	-.301	300	121	.051	.081	.431	-.203	300	171	-.093	.040	.161	-.224

APPENDIX A -- PRESSURE DATA:

C O L U M B I A P L A Z A , D E N V E R

WD	TAP	CPMEAN	CPRMS	CPMAX	CPMIN	WD	TAP	CPMEAN	CPRMS	CPMAX	CPMIN	WD	TAP	CPMEAN	CPRMS	CPMAX	CPMIN
300	172	-.099	.045	.145	-.274	300	222	-.229	.059	-.059	-.561	300	348	-.279	.086	-.040	-.688
300	173	-.146	.048	.050	-.307	300	223	-.200	.057	-.059	-.565	300	349	-.298	.088	-.031	-.683
300	174	-.244	.075	-.022	-.617	300	224	-.209	.058	-.025	-.741	300	350	-.308	.092	-.009	-.665
300	175	-.173	.057	-.011	-.455	300	225	-.196	.052	.000	-.520	300	351	-.321	.094	-.062	-.822
300	176	-.132	.050	.033	-.305	300	226	-.150	.032	-.009	-.273	300	352	-.337	.101	-.097	-.896
300	177	-.125	.043	.046	-.290	300	227	-.148	.030	.004	-.246	300	353	-.362	.111	-.072	-1.171
300	178	-.103	.039	.031	-.268	300	228	-.176	.036	-.049	-.433	300	354	-.371	.119	-.117	-1.426
300	179	-.116	.042	.109	-.266	300	229	-.188	.047	-.031	-.423	300	355	-.258	.082	-.004	-.707
300	180	-.117	.037	.153	-.281	300	230	-.145	.034	.079	-.292	300	356	-.280	.080	.013	-.651
300	181	-.141	.038	.145	-.312	300	231	-.141	.036	.084	-.279	300	357	-.358	.097	-.022	-.891
300	182	-.227	.051	.013	-.491	300	232	-.188	.043	.038	-.346	300	358	-.365	.115	-.015	-.984
300	183	-.115	.041	.027	-.364	300	233	-.177	.031	.000	-.272	300	359	-.255	.057	-.071	-.535
300	184	-.106	.033	.033	-.243	300	234	-.166	.031	-.077	-.317	300	360	-.267	.054	-.058	-.487
300	185	-.088	.041	.145	-.218	300	301	-.245	.105	.000	-.719	300	361	-.289	.058	-.058	-.510
300	186	-.130	.037	.013	-.253	300	302	-.168	.057	.027	-.500	300	362	-.296	.061	-.066	-.568
300	187	-.114	.039	.018	-.330	300	303	-.151	.044	.000	-.391	300	363	-.310	.065	-.095	-.652
300	188	-.104	.030	.051	-.232	300	304	-.145	.052	.020	-.480	300	364	-.324	.070	-.113	-.764
300	189	-.098	.031	.031	-.202	300	305	-.167	.041	-.040	-.329	300	365	-.326	.067	-.116	-.931
300	190	-.081	.032	.077	-.176	300	306	-.267	.099	-.015	-.865	300	366	-.314	.065	-.144	-.778
300	191	-.082	.040	.125	-.199	300	307	-.448	.265	.199	-1.565	300	367	-.239	.060	-.062	-.517
300	192	-.068	.041	.131	-.179	300	308	-.215	.053	-.066	-.615	300	368	-.258	.056	-.073	-.456
300	193	-.086	.047	.143	-.297	300	309	-.215	.044	-.060	-.403	300	369	-.279	.061	-.083	-.611
300	194	-.113	.037	.035	-.227	300	310	-.219	.050	-.057	-.444	300	370	-.294	.060	-.082	-.577
300	195	-.095	.032	.024	-.323	300	311	-.221	.056	-.040	-.471	300	371	-.319	.063	-.135	-.798
300	196	-.106	.039	-.004	-.228	300	312	-.242	.064	-.038	-.545	300	372	-.330	.065	-.168	-1.027
300	197	-.092	.030	.071	-.217	300	313	-.223	.050	-.083	-.510	300	373	-.321	.058	-.175	-.692
300	198	-.083	.031	.097	-.196	300	314	-.241	.067	-.015	-.559	300	374	-.306	.054	-.168	-.643
300	199	-.067	.031	.086	-.191	300	315	-.240	.062	-.073	-.577	300	375	-.172	.037	-.080	-.345
300	200	-.078	.036	.076	-.179	300	316	-.231	.037	-.095	-.396	300	376	-.185	.037	-.064	-.354
300	204	-.090	.030	.022	-.290	300	317	-.244	.038	-.112	-.466	300	377	-.240	.055	-.072	-.452
300	202	-.074	.030	.064	-.169	300	318	-.243	.043	-.088	-.475	300	378	-.268	.058	-.093	-.484
300	203	-.233	.068	-.066	-.669	300	319	-.241	.046	-.075	-.491	300	379	-.325	.057	-.104	-.589
300	204	-.251	.071	-.045	-.654	300	320	-.234	.080	-.004	-.728	300	380	-.339	.063	-.139	-.642
300	205	-.233	.062	-.064	-.626	300	321	-.211	.039	-.038	-.479	300	381	-.330	.064	-.136	-.720
300	206	-.222	.060	-.044	-.572	300	322	-.210	.035	-.106	-.371	300	382	-.320	.060	-.170	-.621
300	207	-.211	.059	-.053	-.603	300	323	-.208	.037	-.091	-.480	300	383	-.193	.052	-.064	-.523
300	208	-.246	.063	-.069	-.643	300	324	-.227	.041	-.102	-.447	300	384	-.198	.034	-.106	-.412
300	209	-.239	.059	-.064	-.644	300	325	-.189	.049	-.045	-.506	300	385	-.307	.057	-.160	-.518
300	210	-.257	.071	-.101	-.616	300	326	-.170	.029	-.075	-.309	300	386	-.346	.078	.568	-.743
300	211	-.252	.075	-.090	-.627	300	327	-.168	.028	-.088	-.303	300	387	-.193	.051	-.077	-.527
300	212	-.280	.081	-.080	-.826	300	328	-.180	.031	-.077	-.312	300	388	-.204	.035	-.093	-.343
300	213	-.276	.085	-.051	-.728	300	329	-.191	.028	-.094	-.325	300	389	-.212	.040	-.086	-.428
300	214	-.280	.093	-.079	-.906	300	330	-.154	.029	-.055	-.298	300	390	-.224	.042	-.108	-.407
300	215	-.296	.105	-.075	-.823	300	331	-.156	.023	-.060	-.250	300	391	-.253	.046	-.104	-.450
300	216	-.312	.106	-.036	-.908	300	332	-.154	.033	-.051	-.339	300	392	-.264	.048	-.111	-.469
300	217	-.297	.110	.086	-.888	300	333	-.158	.025	-.074	-.278	300	393	-.288	.057	-.125	-.496
300	218	-.264	.101	.031	-.796	300	334	-.156	.024	-.075	-.263	300	394	-.317	.071	-.150	-.672
300	219	-.239	.089	.024	-.667	300	335	-.155	.025	-.080	-.292	300	403	-.246	.079	.024	-.529
300	220	-.321	.086	-.112	-.786	300	336	-.166	.028	-.066	-.277	300	404	-.190	.094	.150	-.545
300	221	-.262	.067	-.051	-.668	300	347	-.263	.087	-.042	-.699	300	405	-.200	.105	.221	-.662

WD	TAP	CPMEAN	CPRMS	CPMAX	CPMIN	WD	TAP	CPMEAN	CPRMS	CPMAX	CPMIN	WD	TAP	CPMEAN	CPRMS	CPMAX	CPMIN
300	406	-.225	.137	.248	-.988	315	15	-.081	.038	.092	-.244	315	106	-.174	.058	-.009	-.610
300	407	-.393	.337	.495	-1.592	315	16	-.086	.038	.172	-.213	315	107	-.111	.055	.082	-.323
300	408	-.255	.079	.057	-.613	315	17	-.088	.042	.079	-.295	315	108	.070	.238	.913	-.888
300	409	-.402	.349	.688	-1.728	315	18	-.078	.034	.163	-.187	315	109	-.048	.170	.529	-.532
300	410	-.281	.049	-.110	-.534	315	19	-.186	.029	-.057	-.332	315	110	-.063	.145	.450	-.497
300	411	-.235	.055	.000	-.515	315	20	-.183	.035	-.067	-.331	315	111	-.098	.118	.364	-.464
300	412	-.238	.076	.119	-.739	315	21	-.241	.071	-.024	-.573	315	112	-.173	.085	.210	-.559
300	413	-.297	.149	.223	-1.104	315	22	-.185	.025	-.104	-.289	315	113	-.130	.241	.844	-.719
300	414	-.572	.281	.518	-1.763	315	23	-.177	.034	-.068	-.334	315	114	-.161	.094	.280	-.524
300	415	-.278	.034	-.173	-.440	315	24	-.234	.070	-.030	-.557	315	115	-.006	.123	.577	-.559
300	416	-.242	.035	-.090	-.417	315	25	-.182	.023	-.079	-.271	315	116	.017	.085	.473	-.257
300	417	-.245	.044	-.097	-.573	315	26	-.177	.025	-.072	-.285	315	117	-.018	.079	.347	-.363
300	418	-.282	.092	-.044	-.999	315	27	-.160	.033	-.033	-.303	315	118	-.056	.069	.283	-.348
300	419	-.562	.221	.038	-1.528	315	28	-.182	.061	-.004	-.672	315	119	-.165	.067	.052	-.541
300	420	-.294	.040	-.161	-.496	315	29	-.228	.090	.095	-.989	315	120	-.028	.074	.237	-.458
300	421	-.252	.030	-.137	-.361	315	30	-.143	.071	.222	-.458	315	121	-.026	.045	.228	-.199
300	422	-.235	.030	-.138	-.345	315	31	-.139	.050	.139	-.354	315	122	-.039	.042	.233	-.228
300	423	-.253	.049	-.122	-.522	315	32	-.150	.041	.007	-.350	315	123	-.062	.039	.175	-.236
300	424	-.420	.124	-.062	-.922	315	33	-.210	.042	-.073	-.394	315	124	-.105	.037	.036	-.282
300	425	-.264	.044	-.155	-.480	315	34	-.243	.049	-.046	-.495	315	125	.013	.054	.235	-.199
300	426	-.233	.030	-.130	-.391	315	35	-.144	.062	.147	-.433	315	126	-.023	.035	.127	-.154
300	427	-.221	.029	-.124	-.361	315	36	-.121	.039	.046	-.266	315	127	-.044	.031	.089	-.157
300	428	-.297	.102	.181	-.754	315	37	-.310	.059	-.126	-.619	315	128	-.060	.032	.077	-.176
300	429	-.269	.039	-.164	-.416	315	38	-.108	.067	.141	-.495	315	129	-.113	.027	.007	-.226
300	430	-.225	.031	-.097	-.360	315	39	-.092	.044	.064	-.290	315	130	-.030	.058	.344	-.215
300	431	-.216	.030	-.066	-.345	315	40	-.111	.038	.033	-.239	315	131	-.115	.029	.011	-.225
300	432	-.214	.035	-.044	-.348	315	41	-.178	.036	-.033	-.315	315	132	.034	.058	.252	-.219
300	433	-.218	.040	-.029	-.374	315	42	-.225	.050	-.070	-.435	315	133	-.024	.034	.110	-.151
300	434	-.275	.087	.953	-.722	315	43	-.261	.073	-.051	-.576	315	134	-.045	.030	.061	-.154
300	435	-.182	.026	-.084	-.312	315	44	-.206	.059	-.033	-.533	315	135	-.070	.028	.036	-.173
300	436	-.221	.065	-.015	-.560	315	45	-.201	.050	-.051	-.447	315	136	-.106	.032	.020	-.255
300	437	-.184	.026	-.071	-.266	315	46	-.175	.031	-.054	-.293	315	137	-.064	.032	.064	-.169
300	438	-.161	.026	-.072	-.246	315	47	-.175	.029	.015	-.277	315	138	-.092	.032	.023	-.219
300	439	-.175	.029	-.082	-.274	315	48	-.206	.057	-.020	-.679	315	139	.013	.067	.330	-.227
300	440	-.184	.040	-.031	-.373	315	49	-.187	.032	-.081	-.449	315	140	-.035	.033	.126	-.160
300	441	-.219	.063	-.066	-.735	315	50	-.170	.033	-.033	-.463	315	141	-.057	.030	.046	-.192
315	1	-.075	.038	.110	-.233	315	51	-.161	.025	-.057	-.248	315	142	.010	.066	.350	-.217
315	2	-.056	.044	.111	-.269	315	52	-.208	.036	-.100	-.333	315	143	-.004	.035	.170	-.107
315	3	-.043	.054	.257	-.202	315	53	-.140	.028	-.037	-.262	315	144	-.018	.033	.119	-.147
315	4	-.052	.045	.163	-.229	315	54	-.119	.033	.024	-.265	315	145	-.045	.030	.091	-.153
315	5	-.097	.040	.056	-.225	315	55	-.106	.031	.004	-.248	315	146	-.090	.033	.018	-.249
315	6	-.041	.050	.259	-.224	315	56	-.096	.038	.035	-.305	315	147	-.451	.149	-.109	-1.220
315	7	-.089	.035	.068	-.213	315	57	-.112	.038	.031	-.319	315	148	-.290	.118	-.029	-1.089
315	8	-.056	.054	.141	-.239	315	58	-.106	.032	.007	-.254	315	149	-.236	.096	-.027	-1.036
315	9	-.107	.033	.062	-.218	315	59	-.118	.029	.042	-.224	315	150	-.196	.077	-.014	-.664
315	10	-.095	.043	.169	-.241	315	101	-.156	.047	-.023	-.367	315	151	-.180	.057	-.024	-.569
315	11	-.082	.045	.154	-.248	315	102	-.163	.052	.005	-.396	315	152	-.163	.055	.014	-.606
315	12	-.074	.042	.083	-.218	315	103	-.217	.071	-.018	-.652	315	153	-.179	.051	-.041	-.513
315	13	-.077	.044	.126	-.211	315	104	-.342	.173	.108	-1.193	315	154	-.192	.047	-.070	-.475
315	14	-.084	.030	.048	-.174	315	105	-.377	.113	-.098	-1.063	315	155	-.430	.150	-.089	-1.111

APPENDIX A -- PRESSURE DATA

C O L U M B I A P L A Z A , D E N V E R

WD	TAP	CPMEAN	CPRMS	CPMAX	CPMIN	WD	TAP	CPMEAN	CPRMS	CPMAX	CPMIN	WD	TAP	CPMEAN	CPRMS	CPMAX	CPMIN
315	156	-.283	.129	.007	-.841	315	206	-.202	.044	-.081	-.394	315	322	-.211	.038	-.103	-.488
315	157	-.178	.045	.002	-.463	315	207	-.196	.043	-.064	-.420	315	323	-.215	.046	-.100	-.678
315	158	-.204	.046	-.068	-.443	315	208	-.238	.061	-.074	-.660	315	324	-.236	.048	-.105	-.719
315	159	-.325	.123	-.002	-.943	315	209	-.210	.041	-.104	-.471	315	325	-.163	.029	-.054	-.299
315	160	-.237	.137	.050	-.994	315	210	-.236	.049	-.119	-.612	315	326	-.166	.027	-.083	-.304
315	161	-.178	.096	.050	-.915	315	211	-.224	.048	-.108	-.533	315	327	-.164	.029	-.049	-.303
315	162	-.145	.067	.032	-.603	315	212	-.249	.047	-.103	-.495	315	328	-.186	.035	-.060	-.341
315	163	-.135	.041	.041	-.395	315	213	-.235	.042	-.118	-.442	315	329	-.222	.037	-.093	-.357
315	164	-.135	.040	.027	-.311	315	214	-.226	.040	-.097	-.438	315	330	-.167	.023	-.092	-.253
315	165	-.171	.036	-.041	-.356	315	215	-.241	.049	-.121	-.519	315	331	-.178	.030	-.071	-.292
315	166	-.217	.042	-.086	-.445	315	216	-.253	.050	-.103	-.462	315	332	-.161	.027	-.063	-.273
315	167	-.219	.053	-.080	-.668	315	217	-.225	.045	-.098	-.467	315	333	-.170	.024	-.063	-.256
315	168	-.192	.057	-.005	-.672	315	218	-.196	.038	-.081	-.425	315	334	-.169	.025	-.063	-.264
315	169	-.175	.061	-.011	-.664	315	219	-.173	.034	-.059	-.328	315	335	-.162	.028	-.033	-.270
315	170	-.146	.048	-.011	-.434	315	220	-.286	.047	-.134	-.486	315	336	-.187	.037	-.065	-.372
315	171	-.128	.034	.066	-.293	315	221	-.220	.037	-.104	-.436	315	347	-.198	.046	-.045	-.419
315	172	-.125	.034	.002	-.268	315	222	-.188	.028	-.095	-.330	315	348	-.200	.065	.004	-.533
315	173	-.156	.029	-.032	-.301	315	223	-.156	.025	-.066	-.253	315	349	-.216	.074	.000	-.584
315	174	-.209	.035	-.104	-.373	315	224	-.164	.031	-.062	-.341	315	350	-.222	.084	.013	-.633
315	175	-.182	.037	-.077	-.441	315	225	-.223	.058	-.047	-.545	315	351	-.253	.102	.009	-.801
315	176	-.179	.043	-.030	-.383	315	226	-.168	.035	-.033	-.306	315	352	-.306	.122	.011	-.988
315	177	-.188	.040	-.064	-.334	315	227	-.159	.033	-.011	-.258	315	353	-.392	.143	-.030	-1.147
315	178	-.167	.040	-.042	-.333	315	228	-.183	.030	-.076	-.292	315	354	-.568	.181	-.195	-1.517
315	179	-.166	.041	-.020	-.334	315	229	-.180	.042	-.027	-.427	315	355	-.197	.044	-.078	-.375
315	180	-.157	.034	-.042	-.280	315	230	-.153	.030	-.035	-.282	315	356	-.200	.061	-.022	-.497
315	181	-.160	.033	-.031	-.313	315	231	-.154	.031	-.031	-.304	315	357	-.361	.119	.029	-.991
315	182	-.210	.034	-.073	-.328	315	232	-.220	.033	-.103	-.375	315	358	-.544	.191	-.130	-1.447
315	183	-.208	.047	-.082	-.470	315	233	-.185	.028	-.076	-.289	315	359	-.205	.038	-.080	-.379
315	184	-.196	.051	-.058	-.507	315	234	-.172	.026	-.062	-.284	315	360	-.199	.044	-.052	-.397
315	185	-.150	.033	.000	-.251	315	301	-.204	.064	-.023	-.593	315	361	-.210	.051	-.018	-.486
315	186	-.167	.033	-.031	-.271	315	302	-.153	.048	.000	-.566	315	362	-.217	.061	.058	-.555
315	187	-.209	.047	-.054	-.435	315	303	-.137	.040	-.018	-.312	315	363	-.263	.085	.000	-.676
315	188	-.193	.050	-.016	-.473	315	304	-.133	.043	-.040	-.300	315	364	-.324	.109	.004	-.901
315	189	-.208	.069	-.004	-.568	315	305	-.155	.043	-.025	-.407	315	365	-.396	.125	-.005	-1.147
315	190	-.171	.066	.037	-.489	315	306	-.369	.114	-.054	-1.304	315	366	-.423	.127	-.116	-1.013
315	191	-.111	.036	.016	-.241	315	307	-.479	.306	.301	-1.910	315	367	-.186	.039	-.069	-.344
315	192	-.107	.030	.053	-.227	315	308	-.207	.044	-.072	-.399	315	368	-.190	.048	.011	-.347
315	193	-.175	.040	-.015	-.317	315	309	-.214	.044	-.068	-.518	315	369	-.200	.054	.016	-.416
315	194	-.144	.030	-.026	-.282	315	310	-.215	.047	-.058	-.488	315	370	-.214	.058	.013	-.463
315	195	-.166	.045	-.015	-.383	315	311	-.207	.047	-.065	-.477	315	371	-.260	.068	.009	-.654
315	196	-.196	.047	-.074	-.404	315	312	-.217	.047	-.069	-.511	315	372	-.292	.069	.000	-.623
315	197	-.216	.074	.004	-.493	315	313	-.219	.043	-.097	-.439	315	373	-.308	.066	-.122	-.706
315	198	-.127	.061	.053	-.370	315	314	-.220	.050	-.089	-.548	315	374	-.298	.065	-.125	-.886
315	199	-.056	.039	.097	-.198	315	315	-.209	.039	-.114	-.446	315	375	-.156	.037	-.020	-.310
315	200	-.089	.036	.082	-.241	315	316	-.226	.045	-.090	-.473	315	376	-.162	.045	.036	-.334
315	201	-.185	.063	-.031	-.507	315	317	-.242	.047	-.088	-.602	315	377	-.173	.047	.042	-.337
315	202	-.071	.045	.125	-.236	315	318	-.239	.049	-.096	-.506	315	378	-.184	.055	.000	-.368
315	203	-.213	.058	-.057	-.489	315	319	-.226	.044	-.103	-.415	315	379	-.239	.066	-.031	-.517
315	204	-.232	.055	-.067	-.484	315	320	-.199	.037	-.063	-.356	315	380	-.265	.064	-.071	-.542
315	205	-.212	.049	-.073	-.540	315	321	-.201	.033	-.102	-.344	315	381	-.276	.062	-.077	-.810

APPENDIX A -- PRESSURE DATA:

C O L U M B I A P L A Z A , D E N V E R

WD	TAP	CPMEAN	CPRMS	CPMAX	CPMIN	WD	TAP	CPMEAN	CPRMS	CPMAX	CPMIN	WD	TAP	CPMEAN	CPRMS	CPMAX	CPMIN
315	382	-.263	.048	-.137	-.518	315	440	-.040	.073	.254	-.226	330	49	-.174	.043	.020	-.446
315	383	-.162	.039	-.018	-.373	315	441	-.008	.110	.421	-.410	330	50	-.147	.051	.075	-.333
315	384	-.170	.039	-.037	-.306	330	1	-.065	.061	.229	-.245	330	51	-.129	.034	.000	-.298
315	385	-.244	.035	-.070	-.364	330	2	-.069	.077	.308	-.332	330	52	-.178	.042	-.029	-.337
315	386	-.229	.052	-.086	-.516	330	3	-.012	.085	.432	-.191	330	53	-.124	.036	.027	-.359
315	387	-.164	.043	-.007	-.450	330	4	-.037	.055	.211	-.187	330	54	-.104	.050	.161	-.341
315	388	-.165	.038	-.033	-.355	330	5	-.087	.067	.221	-.283	330	55	-.098	.040	.056	-.258
315	389	-.178	.043	-.020	-.363	330	6	-.011	.089	.463	-.253	330	56	-.116	.038	.015	-.288
315	390	-.188	.048	-.002	-.379	330	7	-.077	.055	.187	-.245	330	57	-.123	.059	.167	-.350
315	391	-.224	.057	-.059	-.465	330	8	-.009	.083	.345	-.477	330	58	-.107	.054	.141	-.330
315	392	-.233	.055	-.079	-.500	330	9	-.092	.050	.134	-.250	330	59	-.117	.042	.069	-.294
315	393	-.242	.060	-.081	-.515	330	10	-.082	.066	.244	-.275	330	101	-.161	.045	.021	-.444
315	394	-.232	.055	-.108	-.545	330	11	-.051	.075	.374	-.263	330	102	-.161	.060	.044	-.461
315	403	-.240	.089	.181	-.518	330	12	-.034	.064	.264	-.218	330	103	-.359	.180	-.042	-1.133
315	404	-.122	.104	.384	-.456	330	13	-.047	.071	.296	-.290	330	104	-.604	.296	.011	-1.518
315	405	-.106	.114	.333	-.505	330	14	-.069	.041	.095	-.174	330	105	-.414	.113	-.105	-.935
315	406	-.093	.132	.465	-.559	330	15	-.093	.048	.185	-.303	330	106	-.147	.044	.035	-.346
315	407	-.005	.214	.730	-.801	330	16	-.097	.033	.046	-.202	330	107	-.115	.062	.113	-.418
315	408	-.233	.089	.173	-.588	330	17	-.135	.060	.074	-.421	330	108	-.397	.266	.452	-1.321
315	409	-.044	.227	.910	-.707	330	18	-.098	.029	.013	-.258	330	109	-.260	.111	.172	-.681
315	410	-.285	.074	.040	-.641	330	19	-.210	.039	-.098	-.385	330	110	-.217	.094	.177	-.505
315	411	-.138	.066	.212	-.395	330	20	-.181	.043	-.033	-.416	330	111	-.210	.075	.123	-.476
315	412	-.083	.074	.228	-.447	330	21	-.256	.094	.033	-.693	330	112	-.272	.067	-.028	-.585
315	413	-.061	.086	.390	-.659	330	22	-.199	.032	-.097	-.383	330	113	-.397	.283	.600	-1.500
315	414	-.059	.154	.707	-1.231	330	23	-.170	.038	-.009	-.369	330	114	-.274	.067	.180	-.571
315	415	-.250	.045	-.108	-.499	330	24	-.260	.088	.081	-.743	330	115	-.350	.296	.448	-1.611
315	416	-.169	.044	.013	-.346	330	25	-.196	.027	-.094	-.301	330	116	-.096	.092	.206	-.718
315	417	-.129	.050	.090	-.399	330	26	-.189	.029	-.068	-.289	330	117	-.115	.068	.244	-.391
315	418	-.091	.073	.269	-.407	330	27	-.154	.036	.004	-.307	330	118	-.163	.064	.164	-.394
315	419	-.065	.114	.289	-.571	330	28	-.165	.065	.037	-.506	330	119	-.290	.067	-.111	-.571
315	420	-.232	.048	-.039	-.458	330	29	-.229	.088	.094	-.933	330	120	-.020	.100	.326	-.505
315	421	-.191	.047	.018	-.441	330	30	-.027	.113	.443	-.449	330	121	-.043	.057	.205	-.312
315	422	-.143	.042	.062	-.333	330	31	-.026	.093	.414	-.378	330	122	-.075	.050	.171	-.325
315	423	-.062	.058	.243	-.296	330	32	-.066	.074	.271	-.339	330	123	-.127	.050	.097	-.363
315	424	-.021	.113	.660	-.406	330	33	-.138	.070	.100	-.503	330	124	-.232	.062	-.048	-.500
315	425	-.220	.050	-.073	-.452	330	34	-.176	.071	.099	-.436	330	125	-.062	.076	.365	-.230
315	426	-.198	.047	-.037	-.425	330	35	-.047	.110	.425	-.416	330	126	-.033	.039	.141	-.187
315	427	-.174	.043	-.035	-.404	330	36	-.018	.076	.370	-.273	330	127	-.065	.034	.081	-.217
315	428	-.062	.101	.568	-.320	330	37	-.220	.097	.069	-.528	330	128	-.101	.037	.030	-.259
315	429	-.215	.043	-.084	-.405	330	38	-.061	.079	.458	-.311	330	129	-.200	.050	-.067	-.437
315	430	-.196	.042	-.046	-.361	330	39	-.002	.071	.361	-.216	330	130	-.069	.052	.302	-.090
315	431	-.174	.038	-.051	-.362	330	40	-.007	.057	.277	-.262	330	131	-.183	.049	-.060	-.525
315	432	-.126	.039	.037	-.259	330	41	-.077	.061	.120	-.341	330	132	-.063	.050	.298	-.144
315	433	-.047	.054	.207	-.227	330	42	-.130	.078	.159	-.504	330	133	-.024	.031	.098	-.123
315	434	-.059	.096	.564	-.289	330	43	-.189	.070	-.002	-.824	330	134	-.056	.028	.053	-.152
315	435	-.161	.041	-.024	-.353	330	44	-.220	.094	.057	-.704	330	135	-.095	.029	-.016	-.217
315	436	-.021	.112	.612	-.333	330	45	-.161	.056	.029	-.630	330	136	-.168	.047	-.032	-.433
315	437	-.163	.037	-.040	-.291	330	46	-.139	.049	.214	-.297	330	137	-.086	.028	.002	-.195
315	438	-.128	.033	-.011	-.249	330	47	-.161	.043	-.009	-.329	330	138	-.140	.040	-.028	-.330
315	439	-.096	.044	.057	-.218	330	48	-.264	.113	.048	-.902	330	139	.014	.057	.326	-.201

APPENDIX A -- PRESSURE DATA

C O L U M B I A P L A Z A , D E N V E R

WD	TAP	CPMEAN	CPRMS	CPMAX	CPMIN	WD	TAP	CPMEAN	CPRMS	CPMAX	CPMIN	WD	TAP	CPMEAN	CPRMS	CPMAX	CPMIN
330	140	-.044	.029	.053	-.135	330	190	-.242	.115	.155	-.687	330	306	-.587	.184	.029	-1.413
330	141	-.094	.036	.002	-.286	330	191	-.063	.051	.144	-.286	330	307	-.895	.239	.101	-1.837
330	142	-.009	.048	.251	-.161	330	192	-.087	.043	.135	-.302	330	308	-.237	.058	-.063	-.560
330	143	-.001	.030	.143	-.132	330	193	-.179	.055	.046	-.460	330	309	-.228	.049	-.087	-.431
330	144	-.017	.030	.126	-.135	330	194	-.140	.041	.011	-.308	330	310	-.226	.052	-.065	-.454
330	145	-.054	.028	.130	-.191	330	195	-.255	.081	-.021	-.604	330	311	-.215	.050	-.063	-.509
330	146	-.127	.039	-.023	-.353	330	196	-.284	.089	-.095	-.755	330	312	-.226	.050	-.052	-.431
330	147	-.438	.095	-.240	-.948	330	197	-.309	.123	.117	-.922	330	313	-.243	.053	-.098	-.602
330	148	-.423	.111	-.158	-.998	330	198	-.144	.097	.153	-.627	330	314	-.226	.049	-.025	-.479
330	149	-.419	.120	-.109	-.930	330	199	-.047	.054	.183	-.324	330	315	-.273	.097	-.027	-.846
330	150	-.394	.128	-.081	-.908	330	200	-.039	.046	.169	-.205	330	316	-.283	.101	.011	-.905
330	151	-.352	.119	-.062	-.880	330	201	-.268	.092	-.025	-.757	330	317	-.291	.098	-.016	-1.033
330	152	-.319	.115	-.005	-.771	330	202	-.054	.070	.220	-.288	330	318	-.275	.087	-.047	-.944
330	153	-.335	.120	-.049	-.793	330	203	-.318	.094	-.075	-.806	330	319	-.247	.074	-.036	-.797
330	154	-.328	.108	-.069	-.903	330	204	-.290	.091	-.052	-.681	330	320	-.214	.089	.052	-.775
330	155	-.450	.103	-.252	-1.327	330	205	-.268	.078	-.073	-.734	330	321	-.247	.104	.109	-.761
330	156	-.429	.103	-.142	-.897	330	206	-.245	.068	-.050	-.634	330	322	-.293	.129	.054	-1.115
330	157	-.327	.114	-.081	-.756	330	207	-.234	.068	-.043	-.633	330	323	-.316	.127	.027	-1.054
330	158	-.325	.098	-.071	-.864	330	208	-.324	.102	-.061	-.785	330	324	-.332	.111	-.032	-.941
330	159	-.409	.083	-.176	-.904	330	209	-.239	.064	-.062	-.599	330	325	-.142	.039	-.016	-.390
330	160	-.418	.095	-.126	-1.186	330	210	-.328	.085	-.076	-.721	330	326	-.151	.042	.007	-.549
330	161	-.445	.108	-.095	-.956	330	211	-.283	.068	-.050	-.655	330	327	-.158	.045	-.016	-.570
330	162	-.420	.122	-.090	-.896	330	212	-.256	.064	-.041	-.537	330	328	-.198	.054	.029	-.469
330	163	-.325	.112	.000	-1.015	330	213	-.251	.061	-.005	-.556	330	329	-.281	.065	-.105	-.745
330	164	-.275	.102	-.011	-.748	330	214	-.277	.090	-.007	-.817	330	330	-.152	.035	-.041	-.282
330	165	-.267	.080	-.026	-.702	330	215	-.291	.082	-.078	-.699	330	331	-.203	.060	.007	-.491
330	166	-.290	.069	-.071	-.620	330	216	-.225	.070	-.018	-.602	330	332	-.149	.037	-.011	-.277
330	167	-.405	.088	-.171	-.779	330	217	-.207	.060	.007	-.496	330	333	-.152	.032	-.048	-.276
330	168	-.416	.116	-.151	-1.002	330	218	-.186	.057	.039	-.446	330	334	-.156	.037	-.023	-.336
330	169	-.437	.149	-.053	-1.325	330	219	-.184	.075	.041	-.560	330	335	-.161	.047	-.027	-.356
330	170	-.398	.151	.007	-1.205	330	220	-.244	.071	-.018	-.602	330	336	-.213	.062	-.016	-.526
330	171	-.263	.120	.148	-.724	330	221	-.207	.057	-.043	-.494	330	347	-.181	.037	-.070	-.414
330	172	-.212	.102	.154	-.608	330	222	-.177	.048	-.032	-.526	330	348	-.150	.037	-.027	-.347
330	173	-.192	.087	.223	-.599	330	223	-.138	.039	-.002	-.306	330	349	-.155	.039	.011	-.296
330	174	-.241	.067	.076	-.682	330	224	-.107	.042	.018	-.478	330	350	-.154	.042	.061	-.348
330	175	-.312	.083	-.088	-.786	330	225	-.208	.073	-.025	-.531	330	351	-.170	.044	-.005	-.371
330	176	-.325	.094	-.108	-.920	330	226	-.151	.046	.000	-.400	330	352	-.209	.053	-.011	-.422
330	177	-.345	.103	-.128	-1.089	330	227	-.134	.041	.027	-.276	330	353	-.267	.071	-.068	-.600
330	178	-.320	.098	-.009	-.758	330	228	-.125	.037	.016	-.262	330	354	-.677	.190	-.120	-1.397
330	179	-.220	.097	.097	-.735	330	229	-.170	.063	.000	-.487	330	355	-.174	.035	-.074	-.326
330	180	-.194	.085	.156	-.528	330	230	-.132	.042	.034	-.348	330	356	-.131	.035	-.007	-.265
330	181	-.164	.074	.124	-.513	330	231	-.128	.040	.064	-.265	330	357	-.209	.061	-.018	-.470
330	182	-.196	.054	.021	-.434	330	232	-.147	.039	.007	-.289	330	358	-.670	.166	-.099	-1.316
330	183	-.262	.088	-.072	-.800	330	233	-.148	.033	-.014	-.263	330	359	-.198	.069	.126	-.646
330	184	-.325	.104	-.080	-1.050	330	234	-.147	.034	-.016	-.307	330	360	-.136	.061	.138	-.447
330	185	-.146	.044	.057	-.316	330	301	-.486	.221	-.011	-1.208	330	361	-.118	.057	.146	-.294
330	186	-.161	.046	.007	-.386	330	302	-.181	.079	.079	-.603	330	362	-.104	.059	.172	-.287
330	187	-.277	.089	-.074	-.717	330	303	-.159	.055	.009	-.495	330	363	-.111	.058	.117	-.302
330	188	-.321	.101	-.062	-1.022	330	304	-.162	.058	.045	-.433	330	364	-.160	.078	.100	-.744
330	189	-.367	.121	.069	-.908	330	305	-.264	.075	-.073	-.629	330	365	-.321	.154	.139	-1.017

WD	TAP	CPMEAN	CPRMS	CPMAX	CPMIN	WD	TAP	CPMEAN	CPRMS	CPMAX	CPMIN	WD	TAP	CPMEAN	CPRMS	CPMAX	CPMIN
330	366	-.799	.193	-.034	-1.488	330	424	.241	.131	.760	-.103	345	33	-.078	.043	.094	-.285
330	367	-.215	.068	.007	-.547	330	425	-.194	.063	.029	-.515	345	34	-.115	.046	.020	-.378
330	368	-.170	.065	.082	-.456	330	426	-.187	.053	.031	-.412	345	35	.027	.072	.429	-.182
330	369	-.162	.075	.116	-.531	330	427	-.174	.051	-.002	-.372	345	36	.037	.065	.383	-.145
330	370	-.054	.075	.203	-.397	330	428	.148	.105	.623	-.127	345	37	-.088	.031	.024	-.209
330	371	-.216	.086	.088	-.540	330	429	-.181	.053	.059	-.471	345	38	.009	.065	.472	-.156
330	372	-.285	.097	.061	-.682	330	430	-.179	.048	-.013	-.383	345	39	.057	.068	.486	-.091
330	373	-.347	.115	.032	-.898	330	431	-.166	.046	-.026	-.363	345	40	.041	.066	.383	-.141
330	374	-.269	.131	.056	-.822	330	432	-.122	.044	.026	-.315	345	41	-.059	.032	.069	-.203
330	375	-.149	.047	.099	-.362	330	433	-.028	.052	.187	-.205	345	42	-.068	.028	.024	-.195
330	376	-.120	.054	.134	-.424	330	434	.133	.102	.573	-.192	345	43	-.039	.049	.155	-.333
330	377	-.121	.056	.099	-.434	330	435	-.088	.058	.174	-.302	345	44	-.094	.089	.205	-.469
330	378	-.126	.058	.088	-.408	330	436	.011	.081	.452	-.179	345	45	-.057	.063	.294	-.359
330	379	-.182	.068	.155	-.472	330	437	-.088	.053	.143	-.275	345	46	-.079	.055	.266	-.235
330	380	-.222	.063	.015	-.489	330	438	-.083	.040	.093	-.240	345	47	-.175	.058	.116	-.404
330	381	-.220	.070	.075	-.595	330	439	-.071	.037	.093	-.194	345	48	-.168	.092	.222	-.716
330	382	-.198	.063	-.007	-.632	330	440	-.030	.060	.358	-.170	345	49	-.157	.042	.094	-.367
330	383	-.123	.042	.026	-.339	330	441	-.011	.074	.566	-.189	345	50	-.113	.058	.149	-.340
330	384	-.116	.049	.381	-.326	345	1	-.147	.032	.131	-.281	345	51	-.101	.045	.091	-.249
330	385	-.196	.083	.044	-.635	345	2	-.153	.036	.195	-.303	345	52	-.135	.036	.013	-.262
330	386	-.176	.090	.082	-.700	345	3	-.131	.037	.069	-.284	345	53	-.140	.035	-.022	-.298
330	387	-.119	.044	.120	-.500	345	4	-.117	.044	.141	-.324	345	54	-.135	.039	.031	-.312
330	388	-.112	.048	.088	-.297	345	5	-.132	.036	.040	-.254	345	55	-.124	.037	.011	-.344
330	389	-.116	.053	.101	-.348	345	6	-.100	.057	.231	-.316	345	56	-.109	.036	.051	-.242
330	390	-.118	.057	.104	-.348	345	7	-.123	.035	.049	-.251	345	57	-.148	.037	.020	-.381
330	391	-.142	.067	.153	-.463	345	8	-.114	.054	.121	-.311	345	58	-.136	.034	.009	-.255
330	392	-.160	.070	.044	-.478	345	9	-.133	.034	.020	-.265	345	59	-.134	.033	.016	-.255
330	393	-.182	.082	.132	-.599	345	10	-.126	.044	.081	-.321	345	101	-.246	.097	-.014	-.699
330	394	-.184	.090	.099	-.925	345	11	-.108	.044	.127	-.240	345	102	-.266	.122	.095	-.847
330	403	-.080	.087	.278	-.403	345	12	-.098	.044	.167	-.368	345	103	-.638	.155	-.156	-1.262
330	404	.053	.117	.481	-.345	345	13	-.112	.044	.185	-.265	345	104	-.839	.149	-.164	-1.411
330	405	.063	.127	.511	-.374	345	14	-.107	.033	.090	-.266	345	105	-.354	.092	-.131	-.668
330	406	.101	.155	.659	-.388	345	15	-.102	.040	.080	-.291	345	106	-.160	.060	.042	-.471
330	407	.042	.179	.652	-.577	345	16	-.107	.033	.099	-.249	345	107	-.204	.089	.153	-.562
330	408	-.018	.092	.330	-.378	345	17	-.119	.037	.058	-.265	345	108	-.823	.227	-.125	-1.571
330	409	.073	.204	.855	-1.066	345	18	-.114	.031	.000	-.345	345	109	-.417	.123	-.157	-1.107
330	410	-.185	.093	.159	-.535	345	19	-.190	.034	-.071	-.358	345	110	-.313	.062	-.111	-.703
330	411	.211	.138	.659	-.203	345	20	-.163	.040	-.031	-.408	345	111	-.265	.048	-.081	-.451
330	412	.328	.164	.815	-.070	345	21	-.159	.072	.031	-.570	345	112	-.283	.045	-.116	-.433
330	413	.359	.185	.954	-.075	345	22	-.188	.031	-.072	-.314	345	113	-.887	.257	-.075	-1.670
330	414	.016	.195	.791	-1.044	345	23	-.160	.036	-.009	-.300	345	114	-.277	.045	-.093	-.485
330	415	-.257	.068	-.059	-.535	345	24	-.162	.081	-.093	-.511	345	115	-.756	.304	.130	-1.780
330	416	-.106	.049	.076	-.273	345	25	-.175	.027	-.076	-.274	345	116	-.264	.156	.014	-1.400
330	417	-.010	.054	.282	-.185	345	26	-.175	.029	-.072	-.290	345	117	-.201	.056	-.005	-.465
330	418	.141	.090	.491	-.112	345	27	-.134	.034	-.009	-.255	345	118	-.223	.047	-.039	-.394
330	419	.301	.155	.930	-.110	345	28	-.091	.048	.275	-.337	345	119	-.295	.051	-.137	-.523
330	420	-.202	.054	.009	-.467	345	29	-.154	.083	.098	-.808	345	120	.001	.092	.322	-.410
330	421	-.212	.062	.002	-.465	345	30	.023	.081	.435	-.182	345	121	-.097	.044	.086	-.264
330	422	-.164	.059	.064	-.430	345	31	.033	.074	.480	-.160	345	122	-.134	.039	.026	-.288
330	423	-.007	.066	.262	-.214	345	32	.030	.064	.339	-.181	345	123	-.186	.041	-.023	-.342

APPENDIX A -- PRESSURE DATA:

C O L U M B I A P L A Z A , D E N V E R

WD	TAP	CPMEAN	CPRMS	CPMAX	CPMIN	WD	TAP	CPMEAN	CPRMS	CPMAX	CPMIN	WD	TAP	CPMEAN	CPRMS	CPMAX	CPMIN
345	124	-.284	.060	-.113	-.493	345	174	-.223	.085	.023	-.675	345	224	-.139	.048	.049	-.462
345	125	-.048	.096	.273	-.446	345	175	-.429	.126	-.174	-1.006	345	225	-.135	.043	.025	-.338
345	126	-.114	.044	.028	-.378	345	176	-.462	.153	-.031	-1.277	345	226	-.127	.036	.037	-.289
345	127	-.133	.036	.000	-.297	345	177	-.440	.162	.014	-1.281	345	227	-.111	.032	.058	-.228
345	128	-.171	.040	-.042	-.336	345	178	-.373	.140	.065	-1.013	345	228	-.192	.049	-.049	-.410
345	129	-.282	.070	-.112	-.614	345	179	-.226	.113	.112	-.818	345	229	-.129	.036	-.009	-.333
345	130	-.188	.100	.193	-.538	345	180	-.165	.085	.118	-.579	345	230	-.122	.032	.019	-.254
345	131	-.192	.044	-.081	-.414	345	181	-.145	.064	.093	-.504	345	231	-.109	.031	.025	-.247
345	132	-.189	.091	.169	-.546	345	182	-.175	.045	-.005	-.395	345	232	-.134	.039	.037	-.273
345	133	-.179	.062	-.005	-.682	345	183	-.291	.091	-.091	-.793	345	233	-.167	.042	-.032	-.343
345	134	-.164	.047	-.044	-.594	345	184	-.286	.094	-.035	-1.026	345	234	-.190	.050	-.005	-.419
345	135	-.159	.037	-.051	-.358	345	185	-.128	.035	.030	-.268	345	301	-.114	.050	.105	-.326
345	136	-.181	.043	-.062	-.416	345	186	-.121	.036	.028	-.284	345	302	-.126	.048	.079	-.345
345	137	-.163	.036	-.059	-.306	345	187	-.291	.086	-.100	-.713	345	303	-.130	.048	.055	-.337
345	138	-.165	.033	-.042	-.350	345	188	-.264	.087	-.005	-.813	345	304	-.211	.054	-.037	-.488
345	139	-.180	.048	.021	-.386	345	189	-.259	.095	.028	-.816	345	305	.327	.007	.354	.303
345	140	-.147	.041	-.016	-.298	345	190	-.188	.075	.141	-.614	345	306	.323	.008	.351	.294
345	141	-.123	.029	.002	-.259	345	191	-.124	.042	.077	-.310	345	307	.328	.016	.383	.266
345	142	-.185	.049	-.049	-.455	345	192	-.108	.033	.060	-.269	345	308	.329	.008	.360	.300
345	143	-.170	.045	-.040	-.400	345	193	-.143	.038	.002	-.303	345	309	.325	.008	.351	.301
345	144	-.151	.045	-.012	-.366	345	194	-.121	.032	-.002	-.330	345	310	.322	.008	.349	.294
345	145	-.148	.039	-.028	-.283	345	195	-.218	.058	-.088	-.738	345	311	-.765	.140	-.252	-1.295
345	146	-.152	.030	-.035	-.262	345	196	-.242	.063	-.103	-.583	345	312	-.337	.151	.005	-.946
345	147	-.344	.057	-.163	-.600	345	197	-.202	.069	.007	-.655	345	313	-.289	.101	-.030	-.709
345	148	-.344	.065	-.130	-.724	345	198	-.146	.049	.049	-.423	345	314	-.261	.087	.025	-.704
345	149	-.356	.064	-.136	-.661	345	199	-.102	.039	.067	-.281	345	315	-.397	.107	-.102	-.872
345	150	-.354	.066	-.148	-.742	345	200	-.109	.039	.149	-.254	345	316	-.661	.143	-.226	-1.517
345	151	-.342	.082	-.044	-.762	345	201	-.191	.062	-.025	-.584	345	317	-.846	.142	-.362	-1.520
345	152	-.346	.085	-.056	-.745	345	202	-.108	.039	.116	-.243	345	318	-.257	.081	.067	-.631
345	153	-.347	.099	-.044	-.857	345	203	-.279	.092	.009	-.662	345	319	-.285	.090	.049	-.779
345	154	-.342	.103	.000	-.865	345	204	-.268	.092	-.021	-.790	345	320	-.302	.102	-.048	-.926
345	155	-.341	.050	-.195	-.551	345	205	-.220	.081	.032	-.690	345	321	-.311	.096	-.069	-1.059
345	156	-.342	.062	-.111	-.592	345	206	-.215	.072	.035	-.511	345	322	-.304	.083	-.067	-1.065
345	157	-.347	.091	-.047	-.883	345	207	-.234	.080	.060	-.789	345	323	-.285	.087	-.049	-.756
345	158	-.337	.097	-.007	-.775	345	208	-.310	.094	-.037	-.678	345	324	-.290	.087	-.052	-.858
345	159	-.380	.066	-.195	-.683	345	209	-.258	.085	.035	-.797	345	325	-.366	.169	.089	-1.188
345	160	-.390	.070	-.197	-.699	345	210	-.354	.081	-.102	-.729	345	326	-.393	.150	.073	-1.083
345	161	-.420	.076	-.220	-.986	345	211	-.315	.076	-.095	-.644	345	327	-.421	.146	-.018	-1.249
345	162	-.420	.080	-.148	-.861	345	212	-.315	.077	-.054	-.685	345	328	-.395	.133	-.048	-1.168
345	163	-.420	.079	-.067	-.718	345	213	-.285	.078	.000	-.614	345	329	-.367	.126	-.041	-1.000
345	164	-.404	.085	-.102	-.724	345	214	-.347	.146	.046	-1.170	345	330	-.219	.124	.124	-.847
345	165	-.385	.082	-.086	-.680	345	215	-.243	.077	-.007	-.653	345	331	-.257	.133	.178	-.964
345	166	-.364	.090	-.107	-.724	345	216	-.221	.074	.030	-.541	345	332	-.334	.164	.121	-1.241
345	167	-.449	.096	-.207	-.895	345	217	-.189	.067	.097	-.472	345	333	-.423	.175	.032	-1.259
345	168	-.472	.108	-.192	-.926	345	218	-.163	.067	.111	-.451	345	334	-.471	.168	-.110	-1.248
345	169	-.503	.127	-.014	-1.238	345	219	-.168	.096	.150	-.641	345	335	-.167	.054	.005	-.518
345	170	-.514	.129	-.074	-1.053	345	220	-.232	.062	-.035	-.706	345	336	-.172	.054	.055	-.552
345	171	-.405	.132	.056	-1.013	345	221	-.184	.047	-.021	-.514	345	347	.323	.008	.351	.291
345	172	-.309	.125	.028	-.898	345	222	-.160	.039	-.007	-.338	345	348	.327	.007	.351	.294
345	173	-.255	.116	.103	-.708	345	223	-.130	.036	.023	-.369	345	349	.328	.008	.362	.300

APPENDIX A -- PRESSURE DATA

C O L U M B I A P L A Z A , D E N V E R

WD	TAP	CPNEAH	CPRMS	CPMAX	CPMIN	WD	TAP	CPNEAH	CPRMS	CPMAX	CPMIN	WD	TAP	CPNEAH	CPRMS	CPMAX	CPMIN
345	359	.329	.016	.381	-.266	345	378	-.039	.082	.321	-.384	345	414	-.274	.246	.440	-1.319
345	351	-.123	.055	.103	-.326	345	379	-.066	.078	.318	-.412	345	415	-.181	.017	-.124	-.233
345	352	-.137	.060	.122	-.340	345	380	-.096	.067	.185	-.384	345	416	-.097	.042	.045	-.266
345	353	-.142	.070	.153	-.460	345	381	-.105	.064	.102	-.537	345	417	-.047	.057	.285	-.255
345	354	-.437	.165	.162	-1.040	345	382	-.096	.061	.090	-.391	345	418	.037	.078	.461	-.282
345	355	-.183	.052	-.005	-.546	345	383	-.104	.044	.083	-.287	345	419	-.039	.058	.061	-.160
345	356	-.068	.052	.119	-.232	345	384	-.031	.053	.258	-.188	345	420	-.099	.057	.078	-.401
345	357	-.026	.078	.240	-.303	345	385	-.049	.050	.194	-.221	345	421	-.129	.069	.090	-.770
345	358	-.348	.167	.262	-.860	345	386	-.103	.048	.140	-.334	345	422	-.130	.059	.079	-.756
345	359	-.245	.090	.110	-.582	345	387	-.101	.043	.130	-.246	345	423	-.074	.018	-.007	-.113
345	360	-.072	.076	.248	-.294	345	388	-.021	.055	.255	-.188	345	424	.014	.112	.511	-.343
345	361	-.026	.075	.257	-.261	345	389	.009	.063	.343	-.165	345	425	-.170	.070	.047	-.517
345	362	.007	.079	.303	-.214	345	390	.027	.065	.364	-.149	345	426	-.123	.043	.065	-.339
345	363	.025	.077	.321	-.204	345	391	.025	.063	.352	-.155	345	427	-.033	.022	.025	-.099
345	364	.013	.084	.372	-.248	345	392	-.002	.063	.280	-.194	345	428	-.169	.123	.331	-.607
345	365	-.044	.141	.391	-.735	345	393	-.038	.054	.273	-.205	345	429	-.159	.060	.090	-.472
345	366	-.374	.186	.308	-1.097	345	394	-.103	.047	.185	-.280	345	430	-.115	.038	.108	-.260
345	367	-.249	.092	.167	-.592	345	403	.067	.108	.445	-.251	345	431	-.058	.010	-.020	-.097
345	368	-.125	.084	.271	-.424	345	404	.151	.112	.564	-.188	345	432	-.096	.041	.040	-.372
345	369	-.088	.085	.303	-.400	345	405	.116	.115	.479	-.316	345	433	-.112	.044	.113	-.337
345	370	-.063	.078	.306	-.438	345	406	.146	.125	.501	-.321	345	434	-.192	.107	.215	-.673
345	371	-.066	.075	.232	-.415	345	407	-.233	.178	.295	-.890	345	435	-.096	.031	.025	-.298
345	372	-.108	.089	.172	-.551	345	408	-.168	.121	.551	-.181	345	436	-.181	.051	-.009	-.531
345	373	-.226	.127	.125	-.793	345	409	-.295	.238	.422	-1.200	345	437	-.093	.029	.056	-.212
345	374	-.282	.133	.035	-.855	345	410	.029	.126	.580	-.291	345	438	-.076	.024	.011	-.167
345	375	-.176	.067	.119	-.514	345	411	.325	.123	.682	-.025	345	439	-.089	.025	-.005	-.181
345	376	-.069	.079	.220	-.445	345	412	.418	.141	.855	.000	345	440	-.106	.031	.016	-.215
345	377	-.053	.085	.350	-.323	345	413	.410	.144	.872	.000	345	441	-.195	.050	.068	-.454