

Engineering Sciences

MAR 18 1980

Branch Library

RANCHO SECO BUILDING WAKE EFFECTS ON
ATMOSPHERIC DIFFUSION: SIMULATION IN
A METEOROLOGICAL WIND TUNNEL

by

K. J. Allwine
R. N. Meroney
J. A. Peterka

Prepared for
Site Safety Research Branch
Office of Nuclear Regulatory Research
U.S. Nuclear Regulatory Commission
Washington, D.C. 20555

Fluid Dynamics and Diffusion Laboratory
Department of Civil Engineering
Colorado State University
Fort Collins, Colorado 80523



U18401 0074857

March 1978
Revised December 1979

CER77-78KJA-RNM-JAP25

ABSTRACT

RANCHO SECO BUILDING WAKE EFFECTS ON ATMOSPHERIC DIFFUSION: SIMULATION IN A METEOROLOGICAL WIND TUNNEL

Wind tunnel diffusion tests were conducted on 1:500 scale models of the Rancho Seco Nuclear Power Station, California; surrounding buildings, hyperbolic cooling towers, and terrain were similarly modeled in the Meteorological Wind Tunnel at Colorado State University. The purpose was to quantify the effects on diffusion of buildings perturbing the mean flow. The test program consisted of three gaseous tracer releases of gases having no appreciable plume rise from ground, building, and containment vessel top heights. The program was repeated for eight wind directions and cases of unstable, neutral, and stable atmospheric stratification conditions.

Results show that the buildings significantly perturb the dispersion patterns from the flat terrain isolated source release case, hence buildings, hyperbolic towers, and terrain in the immediate vicinity of the release have a major effect. Maximum ground level normalized concentrations occurred during stable stratification. Upwind or downwind presence of the hyperbolic cooling towers was felt by the shift of ground level concentration values toward conditions approximately two categories more unstable than that suggested by the Pasquill-Gifford curves for the background flow stability.

Data from three of the eight wind directions have been examined in some detail. These included 135° , containment building upwind of cooling towers; 225° , cooling towers to the side of the containment vessel wake; and 315° , cooling towers upwind of the containment vessel. If it is assumed that wind tunnel measurements are equivalent to field averaging times of 10 minutes, then the model concentrations adjusted to equivalent one-hour field sampling times overpredict field measurements for these cases by at most a factor of 1.7.

ACKNOWLEDGMENTS

This study was performed under Contract No. AT(49-24)-0236 and NRC -04-76-236 with the Site Safety Research Branch, Office of Nuclear Regulatory Research, U.S. Nuclear Regulatory Commission. Financial assistance is gratefully acknowledged. The guidance of Dr. Robert Abbey, Jr., NRC, in co-ordinating this effort with the field measurements was essential to the completion of this program. Colorado State University Fluid Dynamics and Diffusion Laboratory staff acknowledged for their help in the experimental preparation are Jim Garrison, Jim Maxton, Thatcher Harvey, and the shop personnel. A special thanks goes to Bob Long for his writing of the software for the data reduction.

TABLE OF CONTENTS

<u>Chapter</u>	<u>Page</u>
ABSTRACT	i
ACKNOWLEDGMENTS	iii
LIST OF FIGURES	vi
LIST OF TABLES	ix
LIST OF SYMBOLS	x
1.0 INTRODUCTION	1
2.0 SIMILARITY CRITERIA	4
2.1 Approach Flow	4
2.2 Flow Around Buildings	5
2.3 Concentration Measurements	7
3.0 EXPERIMENTAL	8
3.1 Wind Tunnel	8
3.2 Velocity Measurements	8
3.3 Temperature Measurements	9
3.4 Approach Flows	9
3.4.1 Similarity Parameters From Field Data	9
3.4.2 Approach Flow for Neutral Case	11
3.4.3 Approach Flow for Moderately Stable Case	11
3.4.4 Approach Flow for Slightly Unstable Case	12
3.5 Model	12
3.6 Concentration Measurements	13
3.6.1 Tracer Gas Release System	14
3.6.2 Sample Collection Locations	14
3.6.3 Sample Collection System	14
3.6.4 Sample Analysis System	15
3.7 Flow Visualization	16
3.8 Data Analysis	17
3.9 Procedure	17
4.0 RESULTS AND DISCUSSION	18
4.1 Concentration Measurements	18
4.1.1 Maximum Ground Level Concentrations	20
4.1.2 Ground Level Concentration Isopleths	21
4.1.3 Comparison of Concentration Results With the Gaussian Diffusion Equation	21
4.2 Horizontal and Vertical Dispersion Coefficients	24
4.2.1 Comparison of Dispersion Coefficients With Pasquill-Gifford Predicted Values	25
4.3 Flow Visualization	26

TABLE OF CONTENTS (continued)

<u>Chapter</u>		<u>Page</u>
5.0	SUMMARY	27
	REFERENCES	29
	FIGURES	31
	TABLES	68

LIST OF FIGURES

<u>Figure</u>		<u>Page</u>
1	Meteorological Wind Tunnel	31
2	Velocity Profile, Neutral Conditions	32
3	Velocity Profile, Moderately Stable Stratification	33
4	Velocity Profile, Slightly Unstable Stratification	34
5	Temperature Profile, Moderately Stable Stratification	35
6	Temperature Profile, Slightly Unstable Stratification	36
7	Rancho Seco Topography	37
8a	Picture of Model in Wind Tunnel Looking Northwest	38
8b	Source Locations	38
9	Prototype Sampler Locations	39
10	Concentration Coefficient Isopleth, Neutral, 135 ^o , Release Point C	40
11	Concentration Coefficient Isopleth, Moderately Stable, 135 ^o , Release Point C	41
12	Concentration Coefficient Isopleth, Slightly Unstable, 135 ^o , Release Point C	42
13	Concentration Coefficient Isopleth, Neutral, 135 ^o , Release Point G17	43
14	Concentration Coefficient Isopleth, Moderately Stable, 135 ^o , Release Point G17	44
15	Concentration Coefficient Isopleth, Slightly Unstable, 135 ^o , Release Point G17	45
16	Concentration Coefficient Isopleth, Neutral, 225 ^o , Release Point C	46
17	Concentration Coefficient Isopleth, Moderately Stable, 225 ^o , Release Point C	46
18	Concentration Coefficient Isopleth, Slightly Unstable, 225 ^o , Release Point C	47

LIST OF FIGURES (continued)

<u>Figure</u>		<u>Page</u>
19	Concentration Coefficient Isopleth, Neutral, 225 ^o , Release Point G17	49
20	Concentration Coefficient Isopleth, Moderately Stable, 225 ^o , Release Point G17	50
21	Concentration Coefficient Isopleth, Slightly Unstable, 225 ^o , Release Point G17	51
22	Concentration Coefficient Isopleth, Neutral, 315 ^o , Release Point C	52
23	Concentration Coefficient Isopleth, Moderately Stable, 315 ^o , Release Point C	53
24	Concentration Coefficient Isopleth, Slightly Unstable, 315 ^o , Release Point C	54
25	Concentration Coefficient Isopleth, Neutral, 315 ^o , Release Point G17	55
26	Concentration Coefficient Isopleth, Moderately Stable, 315 ^o , Release Point G17	56
27	Concentration Coefficient Isopleth, Slightly Unstable, 315 ^o , Release Point G17	57
28	Plot of Maximum K_c versus x/h_b for Release Point C .	58
29	Plot of Maximum K_c versus x/h_b for Release Point G17.	59
30	Plot of Ratio of Ground Level Centerline K_c From Gaussian Diffusion Equation to Maximum Observed Ground Level K_c Versus x/h_b for G17 Release	60
31	Plot of Ratio of Ground Level Centerline K_c From Gaussian Diffusion Equation Modified by Gifford to Maximum Observed Ground Level K_c Versus x/h_b for G17 Release	61

LIST OF FIGURES (continued)

<u>Figure</u>		<u>Page</u>
32	Plot of σ_y/h_b versus x/h_b for Release Point C . . .	62
33	Plot of σ_y/h_b versus x/h_b for Release Point G17 . .	63
34	Plot of Ratio of σ_y Observed to σ_y From Pasquill-Gifford Curves Versus x/h_b for G17 Release	64
35	Plot of σ_z/h_b versus x/h_b for Release Point C . . .	65
36	Plot of σ_z/h_b versus x/h_b for Release Point G17 . .	66
37	Plot of Ratio of σ_z Observed to σ_z From Pasquill-Gifford Curves Versus x/h_b for G17 Release	67

LIST OF TABLES

<u>Table</u>		<u>Page</u>
1	Comparison of Modeling Parameters for Model and Prototype	68
2	Modeling Parameters Calculated From Rancho Seco Field Data	69
3	Neutral Boundary Layer Modeling Parameters Calculated From Rancho Seco Field Data	70
4	Maximum Ground Level Concentration Coefficient (K_c) for all Wind Tunnel Runs	71
5	Horizontal and Vertical Dispersion Coefficients From Wind Tunnel Data	72
6	Data, Wind Direction 0°	73
7	Data, Wind Direction 45°	86
8	Data, Wind Direction 90°	99
9	Data, Wind Direction 135°	112
10	Data, Wind Direction 180°	125
11	Data, Wind Direction 225°	138
12	Data, Wind Direction 270°	151
13	Data, Wind Direction 315°	164

LIST OF SYMBOLS

<u>Symbol</u>	<u>Definition</u>
A	reference area = $1.5 h_b^2$
c	constant = 0.5
dy	differential length in the horizontal perpendicular to plume axis
g	acceleration due to gravity
h_b	height of building
h_s	height of release
K	von Karman's constant, $K = 0.4$
K_c	nondimensional concentration coefficient
L	Monin-Obukhov length
p	power law exponent
PG	Pasquill-Gifford stability category
q	pollutant mass per unit of plume area
Q	source flow rate
r^2	coefficient of determination
Re	Reynolds number $Re = UD/\nu$
Ri_b	bulk Richardson Number $Ri_b = g(\Delta T)(\Delta z)/[T(\Delta U)^2]$
t	time
T	temperature
ΔT	temperature difference across some reference layer
U	velocity
U_b	velocity at building height
U_r	reference velocity
U_s	velocity at release point height

LIST OF SYMBOLS (continued)

<u>Symbol</u>	<u>Definition</u>
U_{∞}	freestream velocity
U_*	friction velocity
x	distance downwind from source
y	horizontal perpendicular distance from plume center
\bar{y}	center of pollutant mass
z	vertical distance above ground
z_0	surface roughness
z_r	reference height

Greek Symbols

χ	local concentration
χ_{source}	source strength
σ_y	horizontal dispersion coefficient
σ_z	vertical dispersion coefficient
ν	kinematic viscosity
Γ	adiabatic lapse rate, $\Gamma = 0.0098 \text{ }^{\circ}\text{k/m}$

Release Points

A	auxiliary building top
C	containment vessel top center
G5	ground release, southeast side containment vessel
G17	ground release, northwest side containment vessel

1.0 INTRODUCTION

Wind tunnel diffusion tests were conducted on a 1:500 scale model of the Rancho Seco Nuclear Power Station. The experiments were carried out in the low speed meteorological wind tunnel located in the Fluid Dynamics and Diffusion Laboratory (FDDL) at Colorado State University. Various atmospheric stabilities can be simulated in this wind tunnel.

This wind tunnel study is part of an overall research program developed by the Office of Nuclear Regulatory Research to determine empirically the effect of containment buildings on the atmospheric flow field during different stabilities and over a variety of terrains (Abbey, 1976). This program has consisted of two field studies and two wind tunnel studies. The first field study was carried out at the EOCR complex located at the Idaho National Engineering Laboratory. The corresponding wind tunnel study was conducted in the meteorological wind tunnel of the FDDL at Colorado State University (Hatcher, et al., 1977). The second field study was performed at Rancho Seco, California (Start, et al, 1977), with the corresponding wind tunnel study being the subject of this report.

Three atmospheric stabilities characteristic of the 1975 Rancho SEco feild study were simulated in the wind tunnel. These stabilities were neutral, slightly unstable, and moderately stable. Wind speed and temperature data collected from a 46 meter meteorological tower during the Rancho Seco field program were used to determine the atmospheric stabilities and the approach flows. On the tower,

data were collected at the 4, 16, and 46 meter levels. From this a bulk Richardson number (Ri_b) was calculated by CSU staff over the layer 4 to 46 meters for each of the 23 field tests.

Representative bulk Richardson numbers were chosen from these field results and simulated over the corresponding layer in the wind tunnel experiments. Other approach flow modeling parameters such as surface roughness (Z_o), friction velocity (U_*), and power law exponent (p) were also determined from the field tower data.

The wind tunnel test program consisted of the simultaneous release of four different tracer gases (methane, ethane, propane, and n-butane) from four points near the containment vessel with subsequent measurements of ground-level concentrations up to 800 meters (prototype) downwind (see Figure 8b). These tests were conducted under three different stabilities (neutral, slightly unstable, and moderately stable) for eight different wind directions, giving a total of 24 runs or 96 release conditions. The eight wind directions were at 45° increments starting at zero degrees (north).

Limited flow visualization was also carried out on four wind direction for four stability conditions--the three previously mentioned stabilities plus a very stable case (i.e. $Ri_b = -.32, 0.0, 0.35, \text{ and } \sim 1.0$) Titanium tetrachloride with air as a carrier was used as a visible tracer. Color slides and black and white stills, exposed for one second, were taken to document the flow pattern.

This report will address: the experimental program, certain aspects of the experimental considerations, and a detailed presentation of the concentration results of three of the eight wind directions for two release points and two stability conditions. A complete data set of the results is provided for all the concentration experiments.

2.0 SIMILARITY CRITERIA

Physical modeling of the atmospheric surface layer can be accomplished in a meteorological wind tunnel by maintaining equality between certain prototype and model dimensionless quantities. The similarity parameters important to this study are discussed herein and in Hatcher, et al., (1977). A detailed presentation of modeling criteria for the atmospheric surface layer may be found in Cermak (1971) and Snyder (1972).

2.1 Approach Flow

Similarity of neutral flow conditions in the atmospheric surface layer may be accomplished through equality of the dimensionless parameters

$$\frac{U_*}{U_r} \text{ and } \frac{Z_r}{Z_o} \quad (1)$$

where U_* is the friction velocity, U_r is some reference velocity, Z_o is the surface roughness and Z_r is a reference height. The equality of these dimensionless parameters between model and prototype insure identical logarithmic wind profiles for model and prototype. The logarithmic wind profile, which holds only for a neutral boundary layer and $Z > Z_o$ is

$$\frac{U}{U_*} = \frac{1}{K} \ln \frac{Z}{Z_o}$$

where K is the constant of proportionality, von Karman's constant.

For similarity of stratified shear flows, the dimensionless parameters p and Ri_b maintained equal between model and prototype. Ri_b is the bulk Richardson number and p is the power law exponent.

The bulk Richardson is given as

$$Ri_b = \frac{g}{T} \frac{\Delta T \Delta Z}{(\Delta U)^2} \quad (2)$$

where g is the acceleration due to gravity, ΔT is the temperature difference over a region of interest, ΔZ is the height of the region of interest, ΔU is the velocity difference of the same layer and T is the average temperature through the layer. The bulk Richardson number is a measure of the stability of the atmosphere over a finite layer. A positive Ri_b indicates stable stratification, a negative Ri_b indicates unstable stratification and a Ri_b equal to zero indicates a neutral condition.

P is the exponent in the power law wind profile

$$\frac{U}{U_r} = \left(\frac{Z}{Z_r}\right)^P, \quad (3)$$

and ranges from 0.1 to 0.6 as the stability varies from unstable through neutral to very stable as defined by Ri_b .

It should be noted that large scale atmospheric eddies and meandering associated with time scales of the order of one hour are not modeled in the wind tunnel. This limitation requires adjustment procedures discussed in Section 4.1.

2.2 Flow Around Buildings

Geometric similarity between model and prototype was accomplished by undistorted scaling in the three dimensions. Exact Reynolds number ($Re = U \sqrt{A}/\nu$) similarity between model and prototype was not possible. Very high wind tunnel velocities would be required in order to attain Reynolds number equality.

Reynolds number equality is not necessary when the flow is over sharp-edged geometries. Golden (1961) has shown that for Reynolds numbers exceed a diffusion critical Reynolds number of 11,000 the concentration patterns on the building change very little. Even when Reynolds numbers only exceed about 3,500, there is little detectable variation in the far field plume behavior. For this study the Reynolds number was maintained above 12,000.

The Rancho Seco Nuclear Power Facility is dominated by two large 130 m high hyperbolic coolings towers. Boundary layer tripping wires on the model cooling towers were used to establish separation with reattachment locations similar to those expected on the large prototype facilities. These wires were one-sixteenth inch in diameter running vertically from top to bottom spaced at 30° intervals around the cooling tower.

This prototype study released tracers from sources without significant initial momentum. Consequently, situations where jetting of the emitted tracers from the building cavity region occurs were not considered. It is generally accepted that for $h_s/h_b > 2\frac{1}{2}$ and $U_s/U_{\infty} > 1$ the effluent momentum will result in the escape of effluents from the cavity region (Huber, et al., 1976, and Meroney, et al., 1971). U_s is the velocity at the release point and h_s is the height of the release point. For this study the h_s/h_b ratio for the four release points was 1.0 or less and the U_s/U_{∞} ratio was 0.7 or less.

2.3 Concentration Measurements

Concentration measurements from the wind tunnel study can be compared directly to the field measurements by assuming equality of a dimensionless concentration parameters, K_c , between model and prototype (Halitsky, 1968). K_c , the nondimensional concentration coefficient is defined as

$$K_c = \frac{\chi UA}{Q} \quad (4)$$

where χ is the local concentration, U is a characteristic velocity measured at some reference location related to the vertical projection of the complex buildings in a plane perpendicular to the mean wind, and Q is the source flow rate.

3.0 EXPERIMENTAL

3.1 Wind Tunnel

This study was conducted in the Meteorological Wind Tunnel (MWT) at the Fluid Dynamics and Diffusion Laboratory (FDDL) of Colorado State University. A complete description of this wind tunnel (Figure 1) is given by Plate and Cermak (1963). The tunnel has a test section 26.8 meters long and a nominal cross-sectional area of 1.8 x 1.8 meters. Air velocities can be maintained from 0.5 to 35 meters per second with an ambient turbulence level of less than 0.1 percent. The ceiling is adjustable to eliminate any longitudinal pressure gradient.

The MWT was specifically designed to simulate the atmospheric boundary layer. Air inside the tunnel can be maintained at temperatures from 0°C to 80°C. Plates cooled with an ethylene glycol solution were installed on the floor of the first twelve meter portion of the test section. This permitted the test section floor to be cooled to 0°C over its entire length. The final thirteen meters of the test section floor is equipped with heaters such that when the heaters are operational a temperature gradient of 122°C between the hot floor and cold air can be maintained.

3.2 Velocity Measurements

A Datametrics model 800LV linear flowmeter with a range of 0.0 to 30.5 m/s was used to measure the velocity. A motor driven traverse was used to position the probe for the vertical velocity profiles. Each velocity reading was taken using a Hewlett-Packard Integrating Digital Voltmeter interfaced to the Datametrics. The output signal was integrated for 1 minute and then an average determined. Once the desired velocity profile was established, the velocity was monitored throughout the experiment at the 0.38 meter level.

3.3 Temperature Measurements

Temperature measurements were made with a vertical array of 12 YSI model 44004, Fennal glass-coated bead thermistors. Manufacturer's specifications suggest an accuracy of $\pm 0.2^{\circ}\text{C}$ for this type thermistor. Calibrations confirm this reliability. The thermistors were connected to a YSI model 42 SC Tele-Thermometer with a range of -40°C to 150°C .

3.4 Approach Flow

Three different approach flow conditions were provided by the wind tunnel: one for neutral conditions ($Ri_b = 0$), one for moderately stable stratification ($Ri_b = 0.35$), and one for slightly unstable stratification ($Ri_b = -0.32$). The values for the similarity parameters U_*/U_r , Z_r/Z_o , p and Ri_b were determined from the field data (prototype) and are given in Table 1. The actual values (model) set in the wind tunnel are also given in Table 1. For the neutral case, the Reynolds number ($Re = U \sqrt{A}/\nu$) for prototype and model was 29,000,000 and 12,000, respectively. The bulk Richardson number was set in the wind tunnel over the layer 0.008 to 0.092 meters corresponding to 4 to 46 meters for the prototype.

3.4.1 Similarity Parameters From Field Data

In the 1975 Rancho Seco field study 23 tests were performed by Start, et al., (1977) During these field tests wind and temperature data was collected at 4, 16 and 46 meters on a meteorological tower. The Nuclear Regulatory Commission (1972) criteria based on temperature lapse rate within the first one hundred meters of the atmosphere were used to determine the stability class during each test.

Since the bulk Richardson number was the suitable stability modeling criteria for the wind tunnel, a method other than the NRC criteria was used to assign stability classes to the field data. First the bulk Richardson number was calculated over the 4 to 46 meter level:

$$Ri_b = \frac{g}{T} \frac{(\Delta T/\Delta Z + \Gamma)}{(\Delta U/\Delta Z)^2} = \frac{[m/s^2] [^\circ K/m]}{[^\circ K] [(m^2/s^2)/m^2]} \quad (5)$$

where Γ is the adiabatic lapse rate ($0.0098 \text{ }^\circ K/m$). Second, the Monin-Obukhov length (L) was determined from a curve, presented by Hatcher, et al., (1977), of Z_m/L versus Ri_b , given Ri_b and Z_m which is a matching distance over the layer of interest. Z_m is equal to $(Z_2 - Z_1)/(\ln Z_2/Z_1)$. For the layer 4 to 46 meters, Z_m is equal to 17.20 meters. Finally, the Pasquill-Gifford stability was assigned using Table 6 of Gifford (1975) and the determined L values.

The wind speed data at the 4, 16 and 46 meter levels was fit to a power law curve

$$\left(\frac{U}{U_{46}}\right) = \left(\frac{Z}{46}\right)^p \quad (6)$$

The power law exponent p and coefficient of determination r^2 was determined for each of the 23 field tests. The coefficient of determination is a measure of how well the data fit the power law curve. An r^2 value equal to 1.00 is a perfect fit.

Table 2 lists the Ri_b , L , p and r^2 values, plus the stability class for the field tests. The wake from the hyperbolic cooling towers should have influenced the meteorological tower data for test numbers 6, 9, 13, 16, 19, 21, and 22, since in these cases the towers are directly up or downwind of the meteorological tower.

Based on low r^2 , anomolous appearing values of Ri_b and wake influence, certain tests were eliminated from having useful meteorological tower data for the purpose of specifying the modeling parameters. The final tests utilized for specifying the modeling parameters were: 7, 11 and 22 for neutral; 12, 14, 15 and 21 for moderately stable; and 7 for slightly unstable. The p and Ri_b modeled for the moderately stable and slightly unstable cases were the average value of the chosen field tests.

The modeling parameters for the neutral case Z_o/Z_r and U_*U_r were determined by fitting the 4 and 16 meter wind speed readings for each of tests 7, 11 and 22 to the logarithmic wind profile and solving for U_* and Z_o . The values from the three tests were then averaged. The results of this analysis are presented in Table 3.

3.4.2 Approach Flow for Neutral Case

With the introduction of spires at the test section entrance, the boundary layer developed naturally over the initial 13 meters of fetch upwind of the model to a depth of about 1.8 meters. The velocity profile over the model is given in Figure 2. A power law exponent of 0.15 was determined by a least square fit of the velocity profile to a power law curve. U_*/U_r and Z_o/Z_r values of 0.049 and 2.96×10^{-4} , respectively were determined using the velocity profile up to $Z/Z_r = 0.35$ (16 meters prototype).

3.4.3 Approach Flow for Moderately Stable Case

For the moderately stable case the floor of the meteorological wind tunnel was cooled to 0°C and the air entering the test section

was heated to approximately 55°C . The velocity was adjusted until a desired Ri_b was reached. The tunnel was allowed to equilibrate for 4 to 6 hours. Figures 3 and 5 give the velocity and temperature profiles, respectively. The bulk Richardson number of 0.35 was determined over the layer 0.008 to 0.092 meters. The p value was 0.44.

3.4.4 Approach Flow for Slightly Unstable Case

The wind tunnel floor was heated to approximately 120°C and the air entering the test section was cooled to approximately 0°C . The velocity profile and temperature profiles are given in Figures 4 and 6, respectively. The bulk Richardson number arrived at was -0.32 and the power law exponent was 0.10.

3.5 Model

The 1:500 scale model of the Rancho Seco Nuclear Power Station consisted of 19 plastic buildings, including the two hyperbolic cooling towers, and a terrain fabricated using 3.2 mm masonite as the base with 6.4 mm styrofoam lifts to simulate the topography. Figure 7 illustrates the Rancho Seco topography. The complete terrain was constructed in pieces such that at any of the eight wind directions the appropriate pieces could be fitted together to form a 1.8 by 3.6 m terrain. The model then fit into the 1.8 m wide meteorological wind tunnel with ~ 2 m of terrain upwind and ~ 2 m of terrain downwind of the containment vessel. The topography was not used in the unstable case to permit surface heating near the containment vessel and towers.

The two, 260 mm high, cooling towers dominated the model topography. The next highest structure was the 104 mm high containment

vessel. All of the model buildings and topography were made to scale in the FDDL shop from plant drawings provided by NRC. The containment vessel model was made using an early set of pre-construction drawings. It should be noted that the model was made assuming a containment vessel height of 52 meters, whereas it seems the actual height is nearer 43 to 45 meters (Start, et al., 1977; Abbey, 1976). Figure 8 shows a view of the model in the wind tunnel looking toward the northwest.

3.6 Concentration Measurements

Four tracer gases were released from four 3.2 mm diameter ports on the containment vessel as noted on Figure 8b. Release point "C", 104 mm high, was located at the top center of the containment vessel. Release point "A" was 37 mm high on the south face (the top of the auxiliary building). Two ground level release points "G5" and "G17" were located on the southeast face and on the northwest side of the containment vessel respectively.

The tracer gases used were methane (CH_4), ethane (C_2H_6), propane (C_3H_8) and n-butane (C_4H_{10}). They were released at a concentration of 100% at flow rates varying from 100 to 500 cc/min. These flow rates correspond to exit velocities from the 3.2 mm diameter ports of from 0.13 to 0.63 meters/sec. With these low exit velocities, momentum departure from the cavity region was not a problem.

After the release of the tracer gases began, the sample collection system was flushed several times. Then a final sample was drawn over a period of approximately 30 seconds and held for subsequent analysis. Once samples were isolated within the collection system the tracer gas

flows were terminated to prevent background building in the wind tunnel.

3.6.1 Tracer Gases Release System

The four gases were fed to their respective release port via 3.2 mm tygon tubes. Methane was released from point C, ethane from point G17, propane from G5 and n-butane from A. Each gas came from a Matheson gas cylinder through a two-state regulator, a flow controller and then on to the release port on the containment vessel. The flow rates were measured using a 100 cc soap film flow meter. The flow rates were set so that enough material was present for detection, but the port exit velocity did not exceed the level for escaping the cavity region as previously discussed in Section 2.2.

3.6.2 Sample Collection Locations

A total of 40 samples were collected per run. These samples were taken on the 100, 200, 400, and 800 meter arcs (scaled) downwind of the containment vessel. The prototype sampler locations are shown in Figure 9. These same sampler locations were used in the model study, although a sample was not collected at every grid point. For each wind direction the sampler locations were chosen to best cover where the plume was anticipated to be as determined by smoke visualization. Elevated samples were collected on the centerline of the 200, 400, and 800 meter arcs (scaled).

3.6.3 Sample Collection System

Forty 3.2 mm tygon tubes approximately 8 m in length were fed through the wind tunnel wall and each fastened at a sample grid

location. The other ends of the tubes were connected to a sample withdrawing and containing system designed and built by the FDDL staff. This system consisted of 4 modules with each module able to hold 8 samples. Each sample was isolated in a 60 cc plexiglass container with valves at the inlet and outlet sides. The air sample was drawn into or expelled from the plexiglass container using positive or negative pressure differentials across a flexible plastic diaphragm.

3.6.4 Sample Analysis System

A Hewlett-Packard 5700A gas chromatograph with a flame ionization detector (FID) was used to analyze the samples. The oven was maintained at 145°C, the detector at 250°C with a carrier flow rate through the column of approximately 55 cc/min. The column was a 3.2 mm x 2 m Porapak-R column and the carrier gas was nitrogen. Good separation was achieved for the 4 desired compounds with methane coming off the column first after approximately 15 seconds from injection, and n-butane coming off last after approximately 90 seconds. Consequently, each sample analysis took approximately one and one-half to two minutes.

The chromatograph principle of operation is that the compounds are separated by molecular size as they pass through the column. As each hydrocarbon compound elutes from the column and into the FID it is burned in a hydrogen flame and ionized. The potential set up across the detector is measured by an electrometer, amplified and outputted to a recorder or any other compatible data handling device.

For this study the analog output from the gas chromatograph was converted to a digital signal using a Preston A/D converter which was interfaced to a Hewlett-Packard 1000 computer system.

Therefore, for each sample analyzed the concentration of each tracer was determined and stored on a disc file in the computer system.

Prior to each sample collection a background air sample was taken in the wind tunnel; this amount for each compound was then subtracted from the sample values. The gas chromatograph was calibrated prior to each day's operation.

It should be noted that the electrometer output is proportional to the number of carbon atoms (or methane molecules) that are ionized in the detector. Consequently, only one hydrocarbon compound of known concentration is needed to calibrate the electrometer response. For instance, 30 ppm of propane gives the same total integrated response as 82.5 ppm of methane $[(44/16) \times 30]$. Therefore, the electrometer response can be calibrated based on one compound and all the other compounds can be expressed relative to the calibration gas. For this study the calibration was based on methane and the electrometer response factor was approximately 0.25 ppm $\text{CH}_4/\text{mV-sec}$.

The minimum resolution for the entire sample collection-analysis system was determined to be approximately 1 to 2 ppm as methane.

3.7 Flow Visualization

Titanium tetrachloride with air as a carrier was used as a visible tracer. The air, regulated by a flow controller, passed through a bottle of titanium tetrachloride, and was carried through a 3.2 mm Tygon tube to the release port. For four wind directions (135, 180, 225, 315), for each release point, under each of the 3

stabilities, one-second exposure pictures were taken of the visible plume. These pictures were used for qualitative interpretation and to relate visual observations in field and model. Flow visualization was also carried out on an additional very stable case.

3.8 Data Analysis

The concentration data was normalized to a nondimensional concentration coefficient, K_c . The coefficient K_c is determined from

$$K_c = \frac{\chi U_b A}{\chi_{\text{source}} Q}$$

where χ is the local concentration (ppm) U_b is the velocity at the containment vessel top height of 0.104 m (m/s), A is the reference area which was chosen to be one and one-half times the square of the containment vessel height (0.0163m^2), χ_{source} is the source strength (ppm) and Q is the source flow rate (m^3/sec).

The data was reduced and formatted using a Hewlett-Packard 1000 computer system.

3.9 Experimental Procedure

The procedure for the experiment was as follows: 1) the model, velocity and temperature probes and sampling grid were installed in the wind tunnel; 2) wind tunnel heating and cooling controls were adjusted to achieve the proper thermal stratification; 3) concentration measurements were taken; 4) flow visualization was performed; and 5) the data were processed.

4.0 RESULTS AND DISCUSSION

4.1 Concentration Measurements

The results of the concentration measurements for all the runs are presented in Tables 6 through 13. Each table is a set of 12 pages in which the results for a particular wind direction are summarized. Each page within a table gives the listing of the results of the forty samples collected for a particular stability for a particular release point. For each sample, the corresponding prototype grid point and arc is identified as labeled in Figure 9.

The concentration results are presented in the form of the dimensionless concentration coefficient, K_c , as described in Section 3.8. If the prototype concentration values are displayed in exactly this same form, the model and prototype values can be compared directly.

The Rancho Seco field samples were collected over a one-hour period. Hatcher (1977) suggests that one can reasonably assign a minimum effective full-scale averaging time of 10 minutes to mean laboratory data.

It is known that average maximum concentrations of gaseous dispersion in the atmosphere tend to decrease with increasing sampling time. Since the motion of air flow in lower atmosphere is limited in the vertical direction by the presence of the ground, the magnitude of eddy size in the transverse direction may be much greater than that in the vertical direction. Thus, the meandering behavior or gustiness effect because of the large scale of eddy in the atmosphere causes a greater transverse dispersion. Since the larger eddy motion cannot be produced in the wind tunnel, some adjustments must be made for field application.

This phenomenon, often known as the gustiness effect, was first considered by Inoue (Hino, 1968). He reported that a smoke cloud width increases at a rate proportional to the $1/2$ power of the observation time. Ogura (1959) developed a mathematical model which suggested a $-1/2$ power variation of the maximum concentration with time. Hino (1967) performed a large scale study for a time range from ten minutes to five hours. The study which involved releasing tracer materials from high stacks of thermal electric power stations also gives support to the $-1/2$ power law. Hino also found that atmospheric instability has only small effect on the exponent of the power law, i.e.,

$$\chi \sim \tau^{-1/2}$$

The applicable range of the $-1/2$ law is greater for unstable than for neutral stratification.

An alternative $-1/5$ power law was proposed by Nonhebel. Hino (1968) suggested, however, that the applicable time range for this law is less than ten minutes. Other exponents for the peak to mean concentration ratio from -0.65 to -0.35 depending on meteorological condition, have been recommended by the ASMC Committee on Air Pollution Control. Hinds (1967) measured the peak to mean concentration ratios in a building wake region. Data indicated the $-1/2$ law can also be used satisfactorily to predict the dispersion in the wake flow.

More recently, Brun, et al. (1973) reviewed all prior experiments for peak to mean variations with averaging time. Although they report values of the power law coefficient which vary from 0.12 to 0.86 depending upon stratification and averaging time they conclude a value of 0.5 is most appropriate when transposing from 0.25 to one hour averaging times.

Applying Hino's (1968) minus one half power law,

$$\chi_p = \chi_m \left(\frac{t_p}{t_m} \right)^{-1/2}$$

where χ_p is prototype concentration, χ_m is model concentration, t_p is prototype sampling time, and t_m is model equivalent field sampling time, we have for this study,

$$\chi_p = \chi_m \left(\frac{60}{10} \right)^{-1/2} = 0.4 \chi_m .$$

This means that the wind tunnel measurements overpredict prototype concentrations by a factor of two and one-half for typical near neutral flow conditions.

4.1.1 Maximum Ground Level Concentrations

In Table 4 is provided a list of the maximum ground level dimensionless concentration coefficients for each of the four sampling arcs for all wind tunnel runs. It should be noted that when the wind is from 135° , the cooling towers are directly downwind of the containment vessel, and when the wind is from 315° , the cooling towers are directly upwind of the containment vessel.

The maximum ground-level concentration for each sampling arc occurred during the moderately stable stratification. On the 100 meter arc the highest level was from release point C when the winds were out of the 45° and 90° directions. For the 200 meter arc the maximum

concentrations occurred under the same conditions as on the 100 meter arc. The peak level for the 400 meter arc was measured during a release from C at 90° winds and during a release from G5 at 225° winds. For the 800 meter arc the peak concentration occurred from A at 90° and from G5 at 225° .

4.1.2 Ground Level Concentration Isopleths

In Figures 10 through 27 are presented concentration coefficient isopleths at ground level for wind directions 135° , 225° and 315° . For each wind direction plots are provided for the three stability conditions, for two release points, C and G17. Of the three wind directions, the one not directly influenced by the wake of the cooling towers is the 225° direction. From all the figures it is apparent that the cooling towers significantly alter the concentration pattern under any of the stability conditions. The initial impact of the cooling towers is to increase the plume spread and decrease the downwind concentrations from that of when the towers are not of direct influence.

4.1.3 Comparison of Concentration Results With the Gaussian Diffusion Equation

The maximum observed ground level concentration coefficient versus distance downwind is plotted with the Gaussian diffusion equation evaluated at the centerline with $h_s = 0$ and $Z = 0$ using Pasquill-Gifford values for the horizontal and vertical dispersion coefficients. The results of wind directions 135° , 225° and 315° are presented in Figures 28 and 29. In Figure 28 is displayed the results of release point C for moderately stable and neutral conditions, and release point G17 for the same two stabilities is presented in Figure 29. The

Gaussian diffusion equation evaluated at the centerline with $h_s = 0$ and $Z = 0$ is

$$\frac{\chi UA}{Q} = \frac{A}{\pi \sigma_y \sigma_z},$$

where σ_y and σ_z are the dispersion coefficients from Figures 3-2 and 3-3 in Turner (1969).

For the elevated release, it is apparent that the plume remains aloft to at least 200 m downwind for the 225° wind direction. For the 315° and 135° directions the plume is brought to the ground sooner as a result of the increased mechanical mixing behind the cooling towers.

At approximately 15 building heights downwind (800 m) the results of the neutral case for the 225° wind direction is indicative of a Pasquill-Gifford "C" stability. For the moderately stable stratification the results indicate a Pasquill-Gifford "D" class. This is probably a result of the building wake enhancing the atmospheric dispersion capabilities.

For the 135° direction under moderately stable stratification, the results at 800 meters show a Pasquill-Gifford "C" stability. For neutral, the results indicate a Pasquill-Gifford stability of "B". This shows the additional dispersion due to the presence of the cooling towers.

At 100 meters the Gaussian predicted concentration over estimates the observed concentration by a factor of approximately 17, and at 800 meters the formula overpredicts the observed by a factor of approximately 5 (see Figure 30). Using the argument presented in Section 4.1, that the wind tunnel measurements overpredict prototype concentrations by a factor of two and one-half for near neutral conditions, implies that based on wind tunnel results, the Gaussian diffusion equations over estimates

prototype concentrations by a factor of 43 at 100 meters for a ground level release. Start, et al., (1977) says, based on actual field measurements at Rancho Seco, that the measured ground-level axial concentrations were about 75 times smaller than predicted by the Gaussian diffusion equation. This then implies that for a ground release the wind tunnel over predicts the actual centerline ground level concentration by a factor of approximately 1.7. Part of this could probably be attributed to excessive plume meandering during the low wind speed inversion conditions. An additional improvement would be made if an averaging time power law coefficient was selected by stratification condition.

In Figure 31 is given a comparison of the wind tunnel measured ground level axial concentration coefficient and the concentration coefficient determined from a modified Gaussian diffusion equation (Gifford, 1960, 1968). The comparison is in the form of a ratio versus the distance downwind. Wind directions 135° , 225° and 315° for a G17 release point are considered. The Gaussian diffusion equation modified by Gifford to account for dispersion in building wakes is

$$\frac{\chi UA}{Q} = \frac{A}{\pi \sigma_y \sigma_z + CA}$$

where C was chosen to be 1/2 (Gifford, 1975). The results show that at 100 meters the Modified Gaussian under predicts the measured concentration by a factor of 0.7 and at 800 meters the Modified Gaussian over estimated by a factor of 2.7.

4.2 Horizontal and Vertical Dispersion Coefficients

The horizontal dispersion coefficient, σ_y , was determined using the method described by Whaley (1974). Only the ground level concentration data was used. First, the mass of pollutant per unit area of plume, q , was determined, where:

$$q = \int K_c dy .$$

Second, the center of pollutant mass, \bar{y} , which is the first moment was calculated:

$$\bar{y} = \frac{1}{q} \int K_c y dy .$$

Then the second moment, σ_y^2 , was determined:

$$\sigma_y^2 = \frac{1}{q} \int K_c (y - \bar{y})^2 dy .$$

σ_y then is the square root of the variance σ_y^2 . All of the integrals were evaluated using Simpson's Rule. σ_y was converted from degrees to meters simply by multiplying the arc radius by the tangent of the angle. This, of course, gives just an approximate measure of the linear plume spread.

The vertical dispersion coefficient was determined by solving the crosswind integrated concentration equation (see Eq. 4, p. 404, Slade, 1968) for σ_z for a ground release, giving;

$$\sigma_z = \frac{(2/\pi)^{1/2} A}{\int K_c dy} .$$

In Table 5 are listed the σ_y and σ_z values for the 135°, 225° and 315° wind directions for release points C and G17 under neutral and moderately stable cases. The low σ_y values on the 800 meter arc of

the 315° wind direction moderately stable stratification appear to be a result of topographic influences. Inspection of the Rancho Seco topography (Figure 7) shows that a portion of the 800 meter samplers are located behind a hill. Apparently, the plume was channeled partly around the hill and also remained aloft after ascending over the top of the hill. Thus the plume passed over a portion of the 800 meter samplers. Inspection of the vertical profile in the data tables for the 315° moderately stable case supports this argument.

The calculation of σ_z from the cross wind integrated concentration equation evaluated at ground level gave some incorrect results because the plume was still mostly aloft at 100 meters downwind for some releases. Hence the extremely high σ_z values on the 100 meter arc for the 225° wind direction, neutral and moderately stable cases for release point C are not significant.

4.2.1 Comparison of Dispersion Coefficients with Pasquill-Gifford Predicted Values

Plots of σ_y/h_b versus x/h_b for wind directions 135°, 225° and 315° for release point C and G17 are shown in Figures 32 and 33 respectively. Also the Pasquill-Gifford values of σ_y for different stabilities are displayed. In Figures 35 and 36 is presented the same information for σ_z/h_b . These plots support the conclusions discussed in the third and fourth paragraphs of section 4.1.3 concerning the effective Pasquill-Gifford stability for each run. In general, the Pasquill-Gifford stability category indicated at 800 meters is one category more unstable than the approach flow stability for the moderately stable and neutral cases when the cooling towers are not affecting the plume (225°). For the cooling towers directly affecting the plume (135°, 315°), the Pasquill-Gifford category is approximately two categories more unstable than the background flow stability.

Figure 34 is a plot of the ratio of σ_y observed to σ_y from Pasquill-Gifford curves versus x/h_b for a G17 release. Also, in this figure is presented the results of the Rancho Seco field data (Start, et al., 1977). For the wind tunnel data the σ_y is approximately a factor of 3.5 times larger than the Pasquill-Gifford σ_y . For the Rancho Seco field data the σ_y is approximately a factor of 5.6 times larger than the Pasquill-Gifford value. This implies that the σ_y from the field data is 1.6 times larger than the σ_y from the wind tunnel data. (Refer again to the discussion in Section 4.1.)

A plot of the ratio of σ_z observed (wind tunnel) to σ_z from Pasquill-Gifford curves versus x/h_b for a G17 release is given in Figure 37. The σ_z for the wind tunnel for wind directions 135° , 225° , and 315° is approximately 2.2 times larger than the σ_z from the Pasquill-Gifford curves.

4.3 Flow Visualization

Black and white stills and color slides exposed for one second provided satisfactory visual documentation of the plume drift. Titanium tetrachloride was used to make the plume visible. Wind directions 135° , 180° , 225° , and 315° were investigated. The pictures and slides are included in a separate text.

5.0 SUMMARY

Twenty-four wind tunnel tests were run on a 1:500 scale model of the Rancho Seco Nuclear Power Station. The atmospheric stabilities investigated were neutral, moderately stable and slightly unstable. Different tracer gases were released from four different release points on the containment vessel and the concentration field downwind was determined. Eight wind directions were investigated.

The bulk Richardson numbers set in the wind tunnel were 0.0, 0.35 and -0.32 corresponding to the three stabilities, with power law exponents of 0.15, 0.44 and 0.10, respectively. The roughness length modeled was that of short grass ($Z_0 = 0.014$ m).

The maximum ground-level dimensionless concentration coefficient for each of the four sampling arcs occurred during the moderately stable stratification. The highest ground-level concentration on all four arcs was measured during the 90° wind direction from release point C.

A fairly thorough investigation of the dispersion characteristics was carried out on three out of the eight wind directions. The wind directions were 135° , 225° and 315° . For the 135° and 315° directions two large hyperbolic cooling towers were directly influencing the plume behavior. The following conclusions will be based only on the above mentioned three wind directions.

Plots of σ_y/h_b versus x/h_b , σ_z/h_b versus x/h_b and K_c versus x/h_b compared with Pasquill-Gifford predicted values for different stability categories provides the following general conclusion: For the case of the cooling towers not affecting the plume (225°), the Pasquill-Gifford stability indicated at 800 meters is one category more unstable than the approach flow conditions. For the cooling towers directly affecting the plume (135° , 315°), the Pasquill-Gifford category

indicated is approximately two categories more unstable than the background flow stability.

On the 100 meter arc, the Gaussian diffusion equation predicted K_c over-estimates the wind tunnel K_c by a factor of approximately 17. It is believed that the wind tunnel over-predicts a one-hour sampling time prototype K_c by a factor of 2.5 for a near neutral stability. From actual field measurements at the Rancho Seco Facility, the measured ground level axial concentrations were about 75 times smaller than predicted by the Gaussian diffusion equation. This implies that for a ground level release the wind tunnel over predicts the actual field concentrations by a factor of approximately 1.7.

On the 100 meter arc, the Gaussian diffusion equation modified by Gifford under predicts the wind tunnel concentration by a factor of 0.7 and at 800 meters the modified Gaussian over-estimates by a factor of 2.7.

The horizontal dispersion coefficient, σ_y , was determined using a moment method and the vertical dispersion coefficient, σ_z , was determined from the crosswind integrated average concentration equation. The average σ_y from the Rancho Seco field study is approximately 1.6 times larger than the σ_y from the wind tunnel data. This can probably be attributed to plume meandering. The σ_z for the wind tunnel data is approximately 2.2 times larger than the σ_z predicted from Pasquill-Gifford curves.

REFERENCES

- Abbey, R. F., 1976, "Concentration Measurements Downwind of Buildings: Previous and Current Experiments," Third Symposium on Atmospheric Turbulence and Diffusion and Air Quality, October 19-22, 1976, Raleigh, North Carolina, pp. 247-254.
- Brun, J., Hugon, J., and Le Quino, R., 1973, "Influence of Exposure Duration on the Evaluation of Coefficients of Atmospheric Diffusion," Proceedings of Symposium on the Physical Behavior or Radioactive Contaminants, Vienna, Austria, November 12-14, 24 pp.
- Cermak, J. E., 1971, "Laboratory Simulation of the Atmospheric Boundary Layer," AIAA Journal, Vol. 9, No. 9, pp. 1746-1754.
- Gifford, F. A., Jr., 1960, "Atmospheric Dispersion Calculations Using the Generalized Gaussian Plume Model," Nuc. Safety, Vol. 2, pp. 56-59, pp. 67-68.
- Gifford, F. A., Jr., 1968, "An Outline of the Theories of Diffusion in the Lower Layers of the Atmosphere," in Meteorology and Atomic Energy - 1968, edited by D. H. Slade, USAEC Report No. TID 24190, pp. 65-116.
- Gifford, F. A., 1975, "Turbulent Diffusion Typing Schemes: A Review," Environmental Research Laboratories, ATDL Report No. 75/2, or, 1976, Nuclear Safety, 17, No. 1, pp. 68-86.
- Golden, J., 1961, "Scale Model Techniques," M.S. Thesis, New York University, Department of Meteorology and Oceanography.
- Hatcher, R. V., Meroney, R. N., Peterka, J. A., and Kothari, K., 1977, "Dispersion in the Wake of a Model Industrial Complex," U.S. Nuclear Regulatory Commission Report NUREG-0378, FDDL Report CER76-77RVH-RNM-JAP-KK35, Colorado State University, Fort Collins, June, 231 pp.
- Hinds, W. T., 1967, "On the Variation of Concentration in Plumes and Building Wakes," USAEC Meteor. Information Meeting, September 11-14, 1967, pp. 105-131.
- Hino, M., 1968, "Maximum Ground Level Concentration and Sampling Time," Atmospheric Environment, Vol. 2, pp. 149-165.
- Hino, M., 1968, "Computer Experiment on Smoke Diffusion Over a Complicated Topography," Atmospheric Environment, Vol. 2, pp. 543-558.
- Huber, A. H., and Snyder, W. H., 1976, "Building Wake Effects on Short Stack Effluents," Preprint Volume, Third Symposium on Atmospheric Turbulence, Diffusion and Air Quality.

- Meroney, R. N., and Yang, B. T., 1971, "Wind Tunnel Study on Gaseous Mixing Due to Various Stack Heights and Injection Rates Above an Isolated Structure," FDDL Report CER71-72RNM-BTY16, Colorado State University, Fort Collins.
- Nuclear Regulatory Commission, 1972, "Onsite Meteorological Programs," NRC Regulatory Guide 1.23, Washington, D. C.
- Ogura, Y., 1959, "Diffusion From a Continuous Source in Relation to a Finite Observation Interval," Adv. Geophysics, Vol. 6, pp. 149-159.
- Plate, E. J., and Cermak, J. E., 1963, "Micro-Meteorological Wind Tunnel Facility: Description and Characteristics," FDDL Report CER63EJP-JEC9, Colorado State University, Fort Collins.
- Slade, D., ed. 1968, Meteorology and Atomic Energy - 1968, U.S. Atomic Energy Commission, Division of Technical Information, 455 pp.
- Snyder, W. H., 1972, "Similarity Criteria for the Application of Fluid Models to the Study of Air Pollution Meteorology" Boundary Layer Meteorology, 3(2), pp. 113-134.
- Start, G. E., Cate, J. H., Dickson, C. R., Ricks, N. R., Ackerman, G. R., and Sagendorf, J. F., 1977, "Rancho Seco Building Wake Effects on Atmospheric Diffusion," Joint Conference on Applications of Air Pollution Meteorology, November 29-December 2, 1977, Salt Lake City, Utah, pp. 357-363.
- Start, G. E., Cate, J. H., Dickson, C. R., Ricks, N. R., Ackerman, G. R., and Sagendorf, J. F., 1977, "Rancho Seco Building Wake Effects on Atmospheric Diffusion," NOAA Technical Memorandum ERL-ARL-69, 185 pp. November.
- Turner, D. B., 1969, "Workbook of Atmospheric Dispersion Estimates," U.S. Department of Health, Education and Welfare, Public Health Service, Cincinnati, Ohio.
- Whaley, H., 1974, "The Derivation of Plume Dispersion, Parameters From Measured Three-Dimensional Data," Atmospheric Environment, Vol. 8, pp. 281-290.

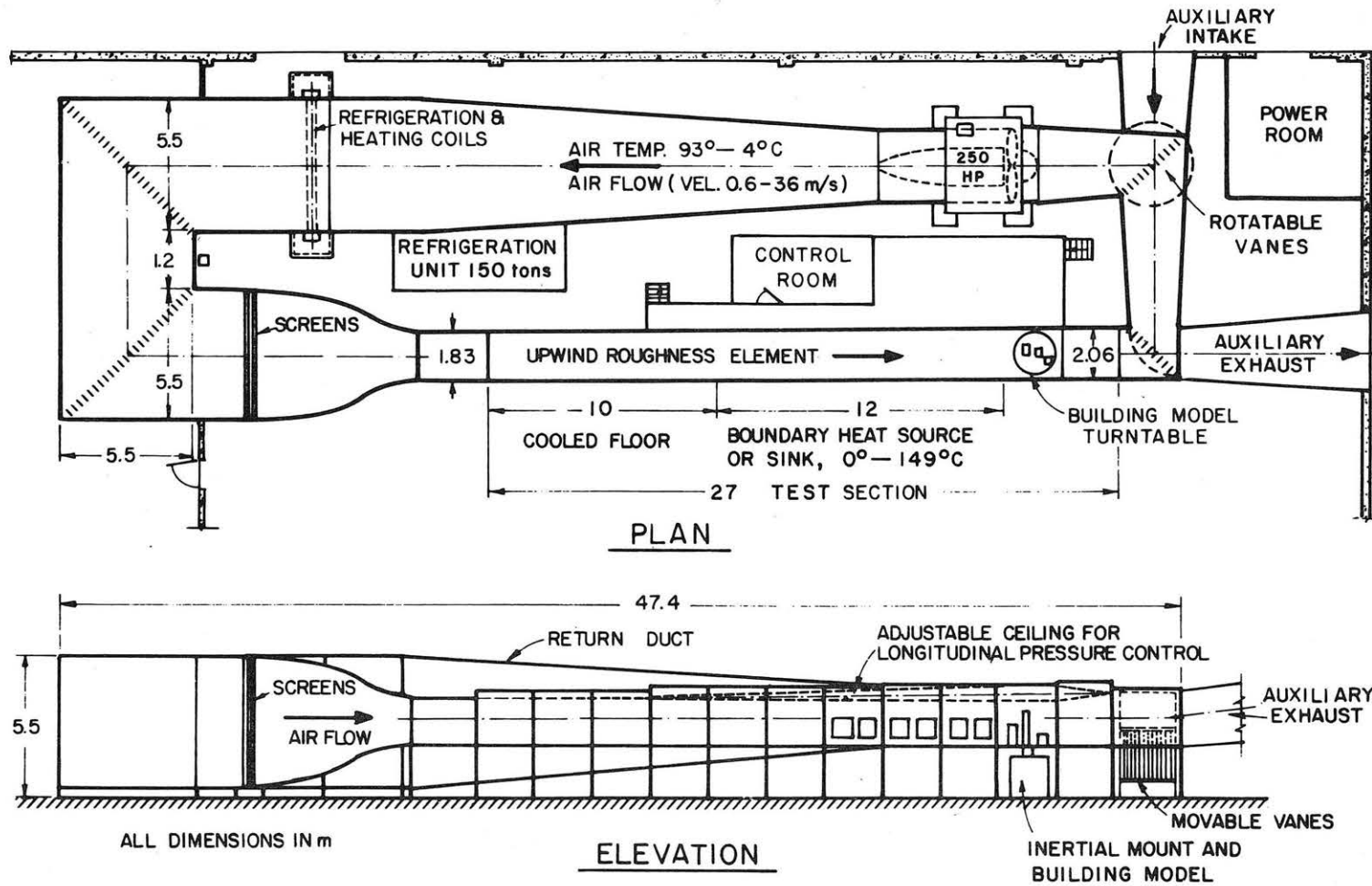

Figure 1. METEOROLOGICAL WIND TUNNEL (Completed in 1963)
 FLUID DYNAMICS & DIFFUSION LABORATORY
 COLORADO STATE UNIVERSITY

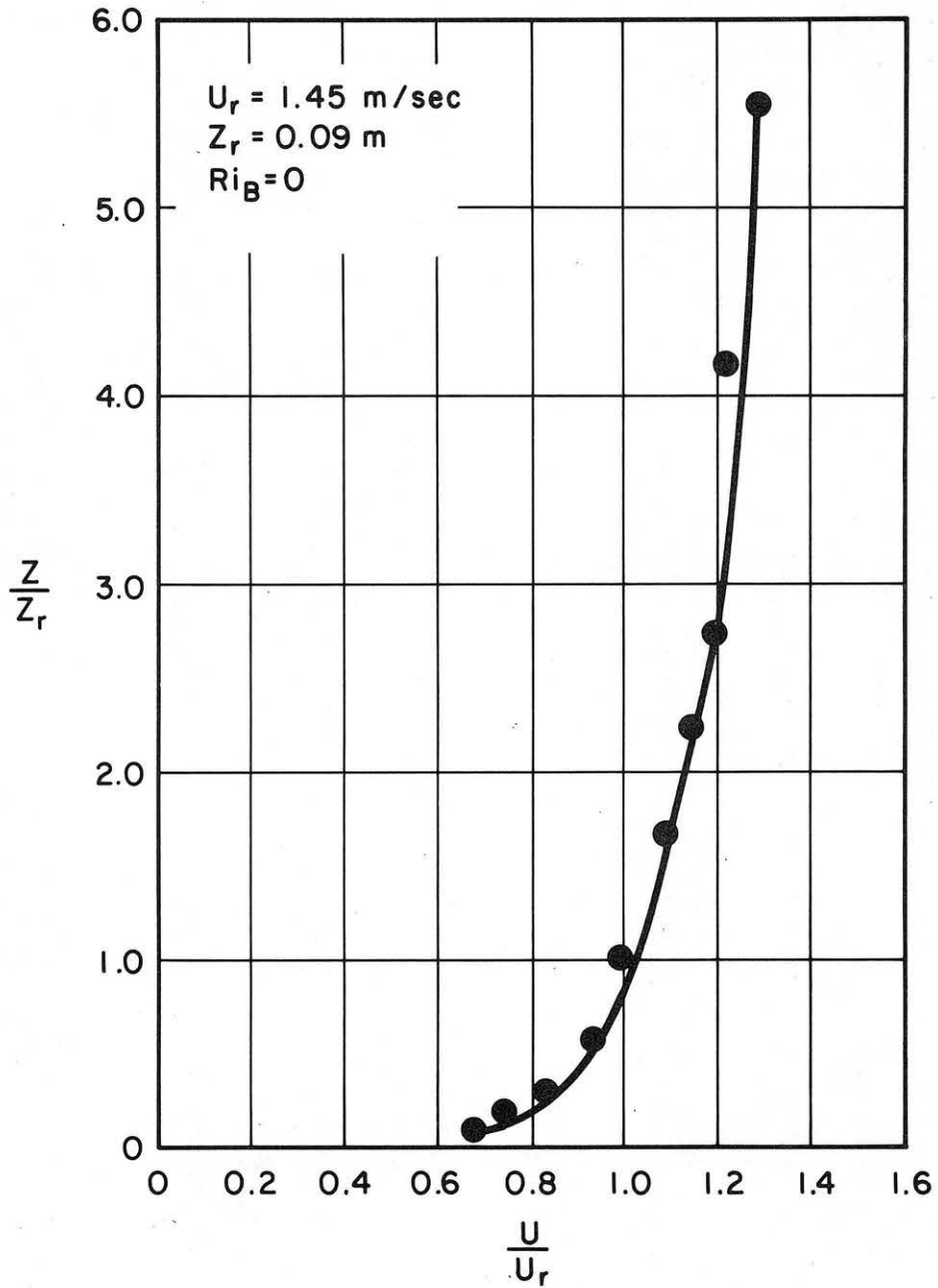

Figure 2. Velocity Profile, Neutral Condition

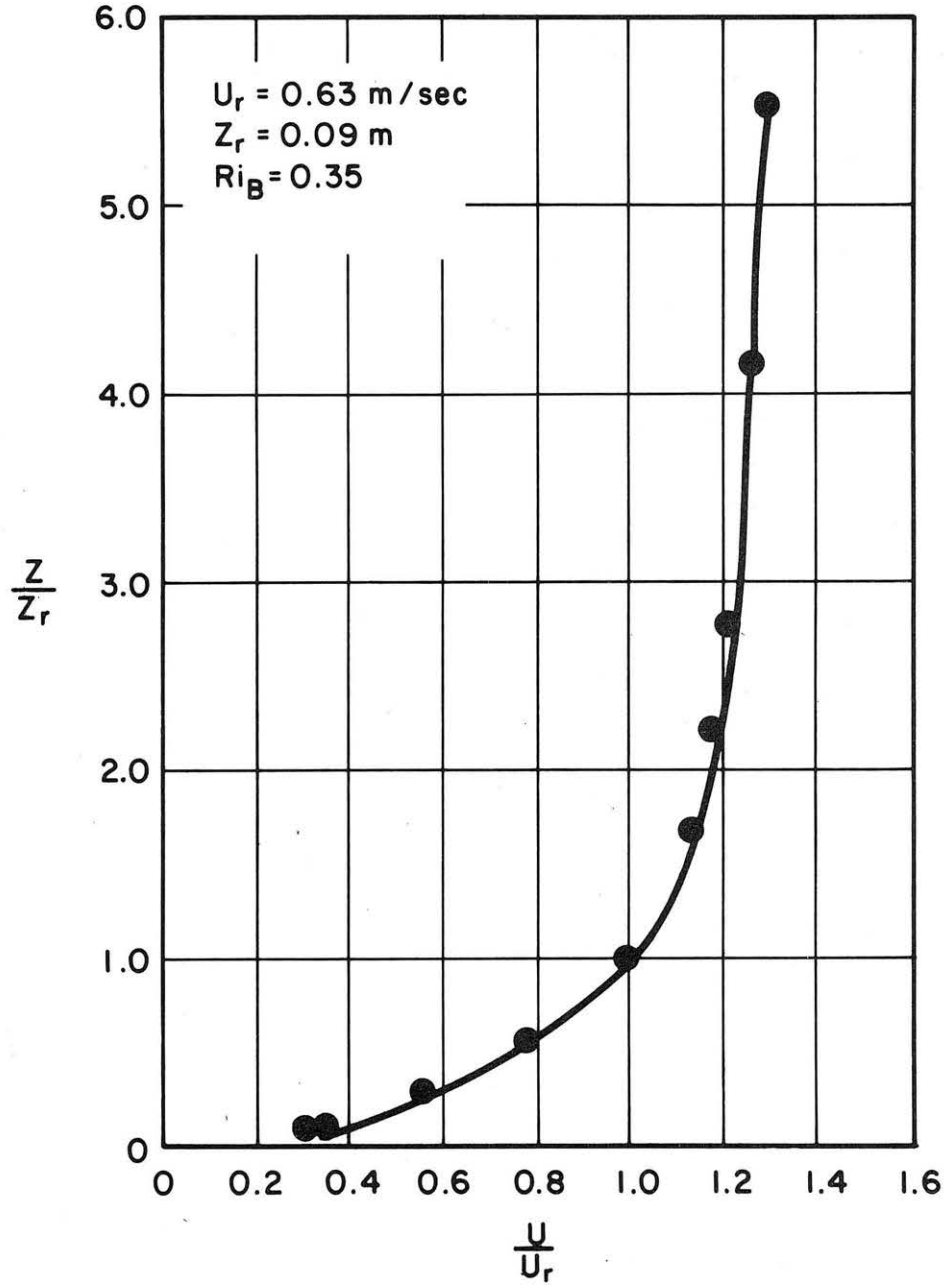

Figure 3. Velocity Profile, Moderately Stable Stratification

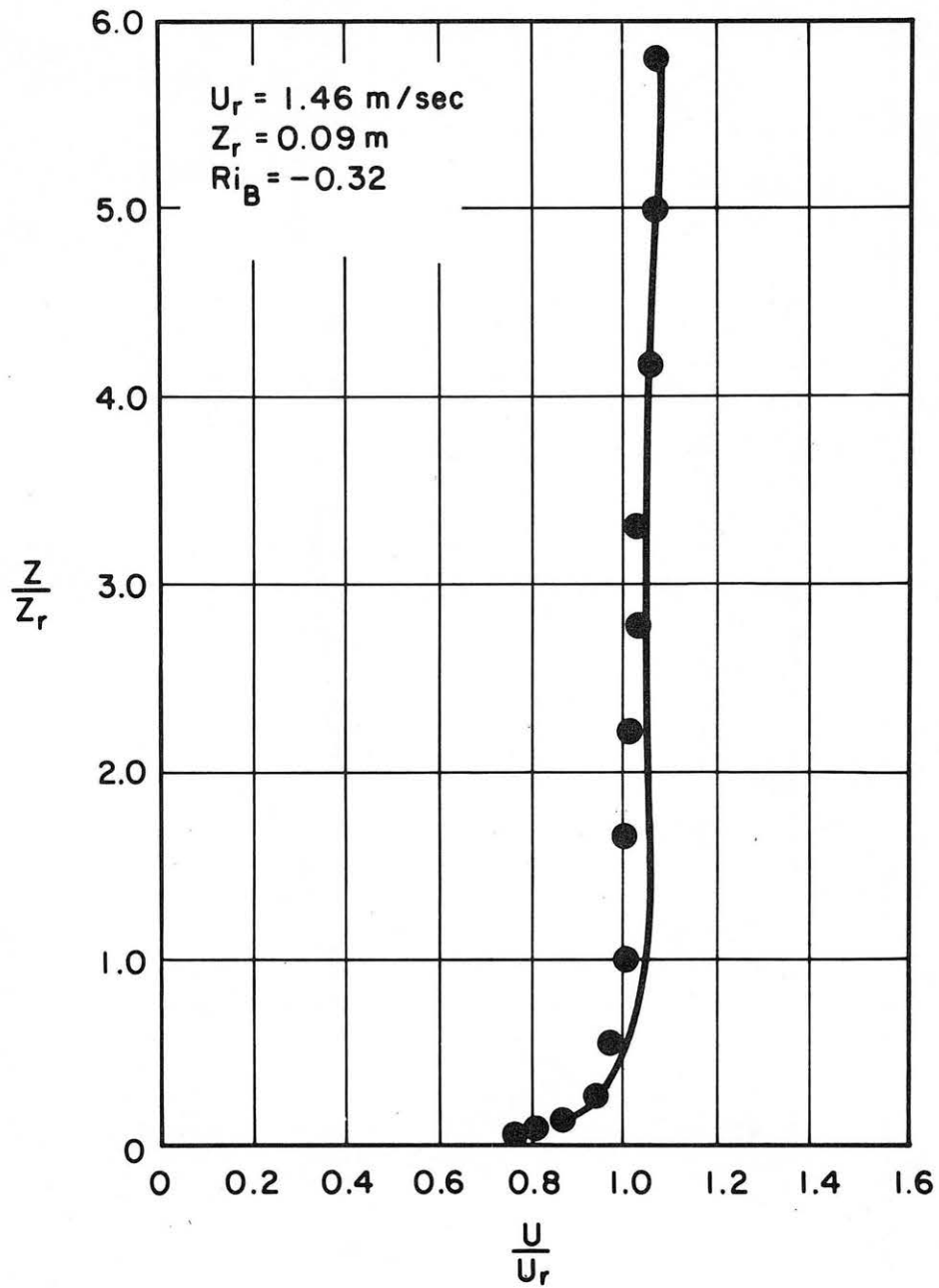

Figure 4. Velocity Profile, Slightly Unstable Stratification

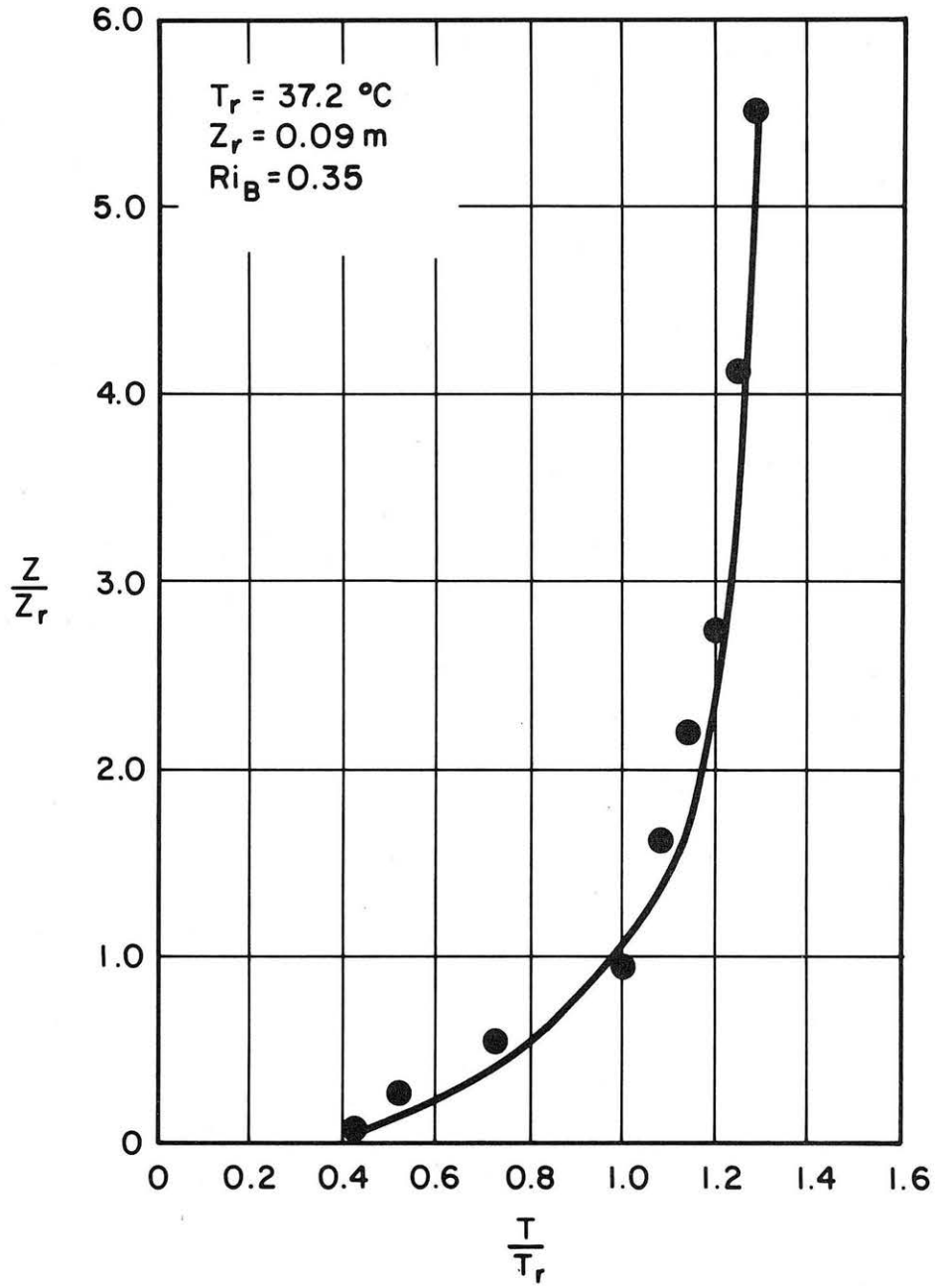

Figure 5. Temperature Profile, Moderately Stable Stratification

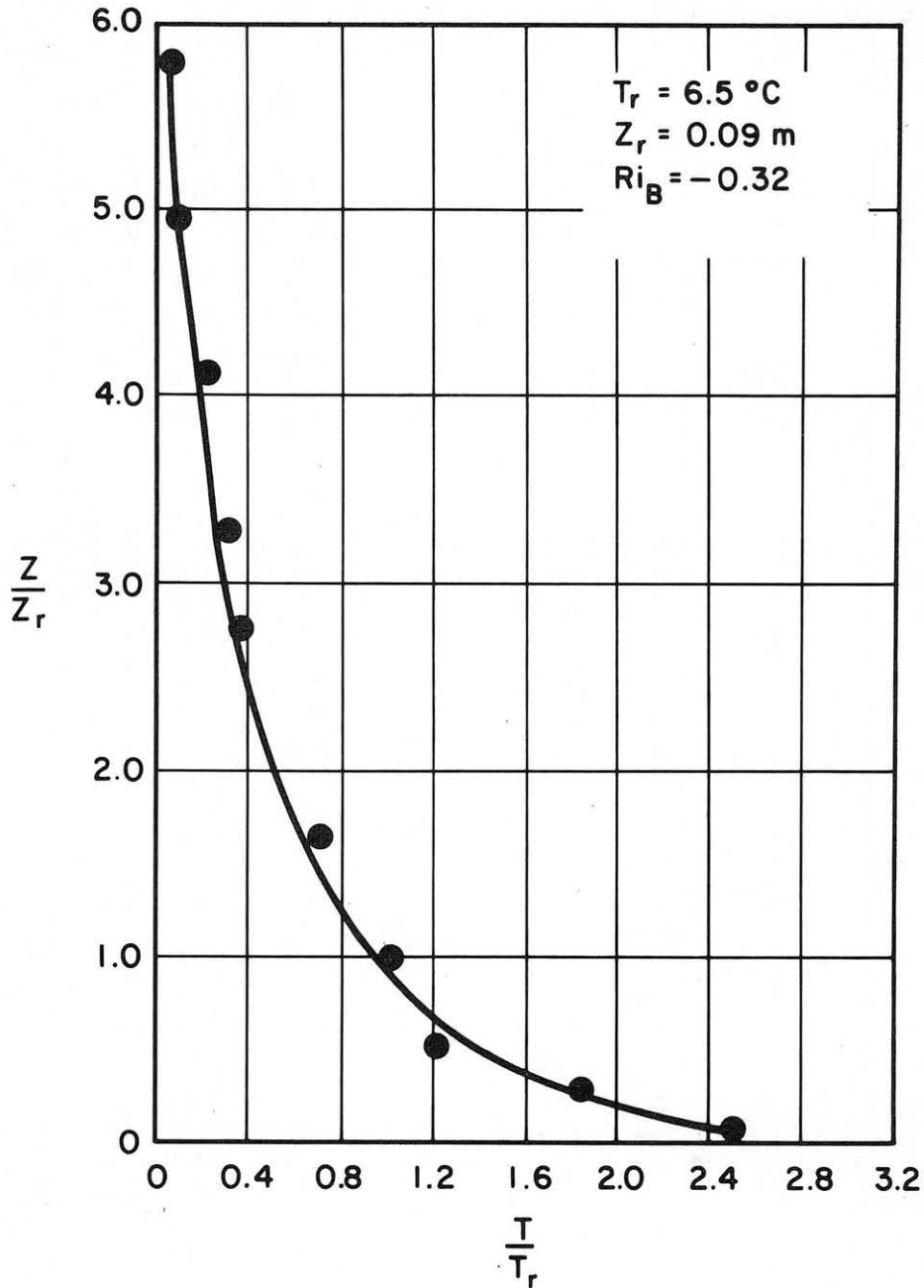

Figure 6. Temperature Profile, Slightly Unstable Stratification.

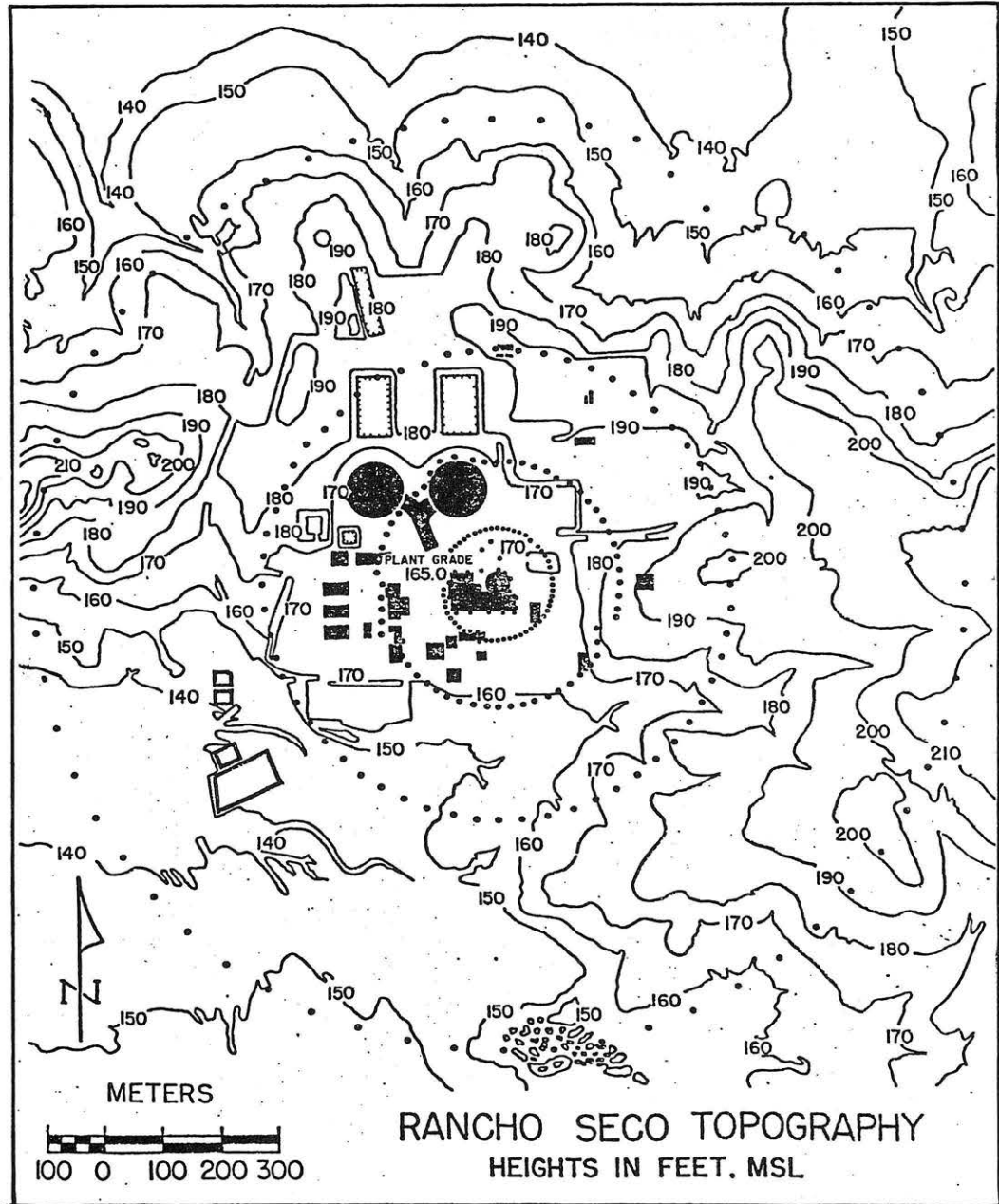

Figure 7. Rancho Seco Topography

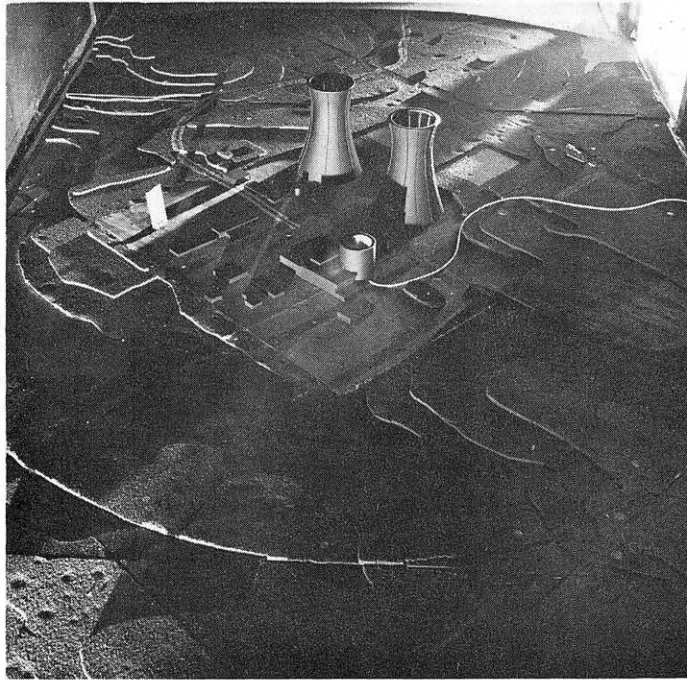

Figure 8a. Picture of Model in Wind Tunnel Looking Northwest

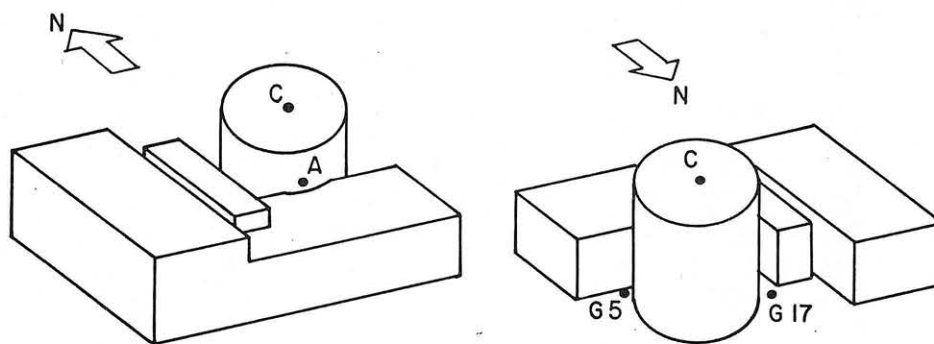

Figure 8b. Source Locations

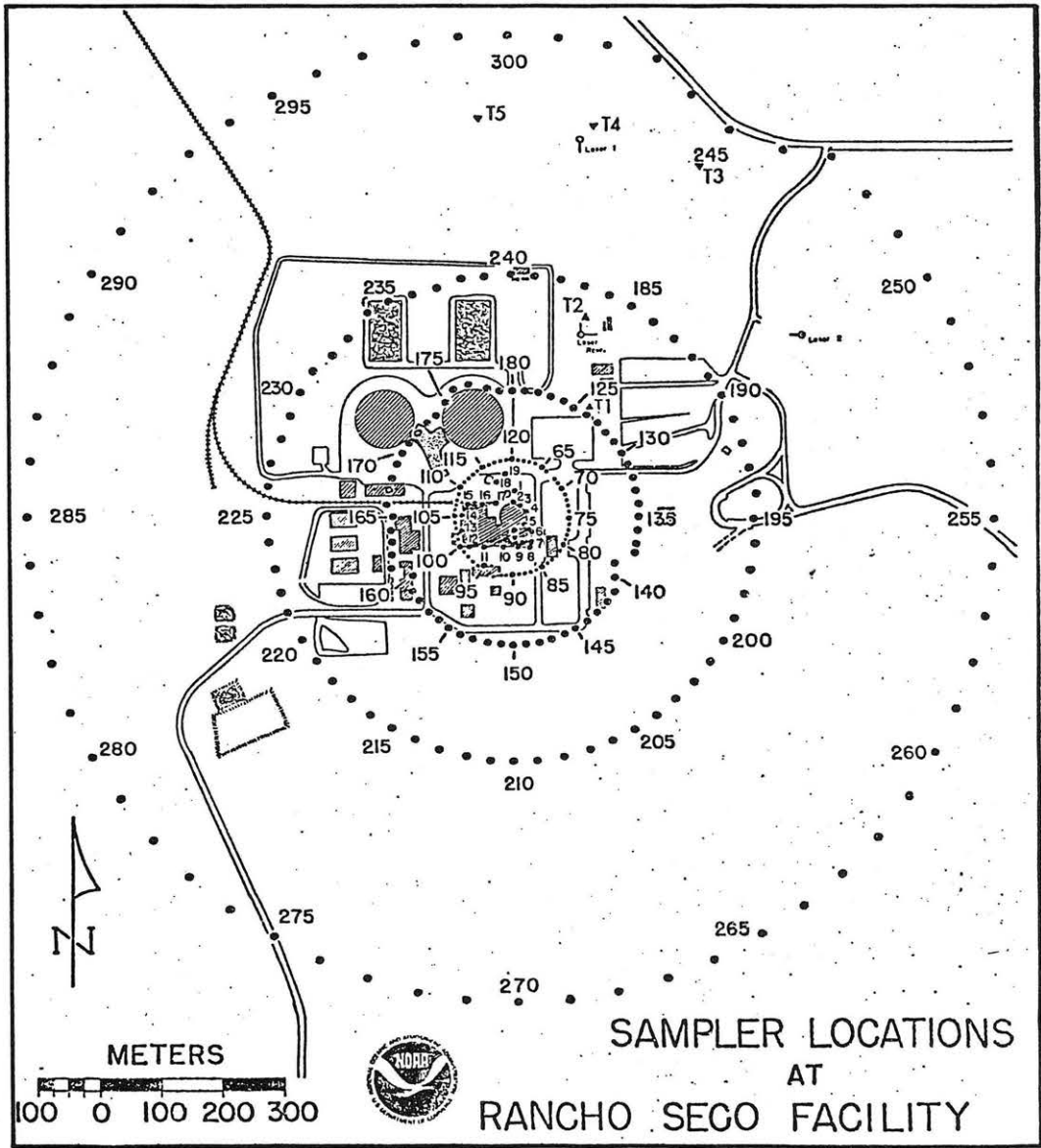

Figure 9. Prototype Sampler Locations

Concentration Coeff. Isopleths

Stability - Neutral

Wind Dir. - 135°

Release Pt. - C

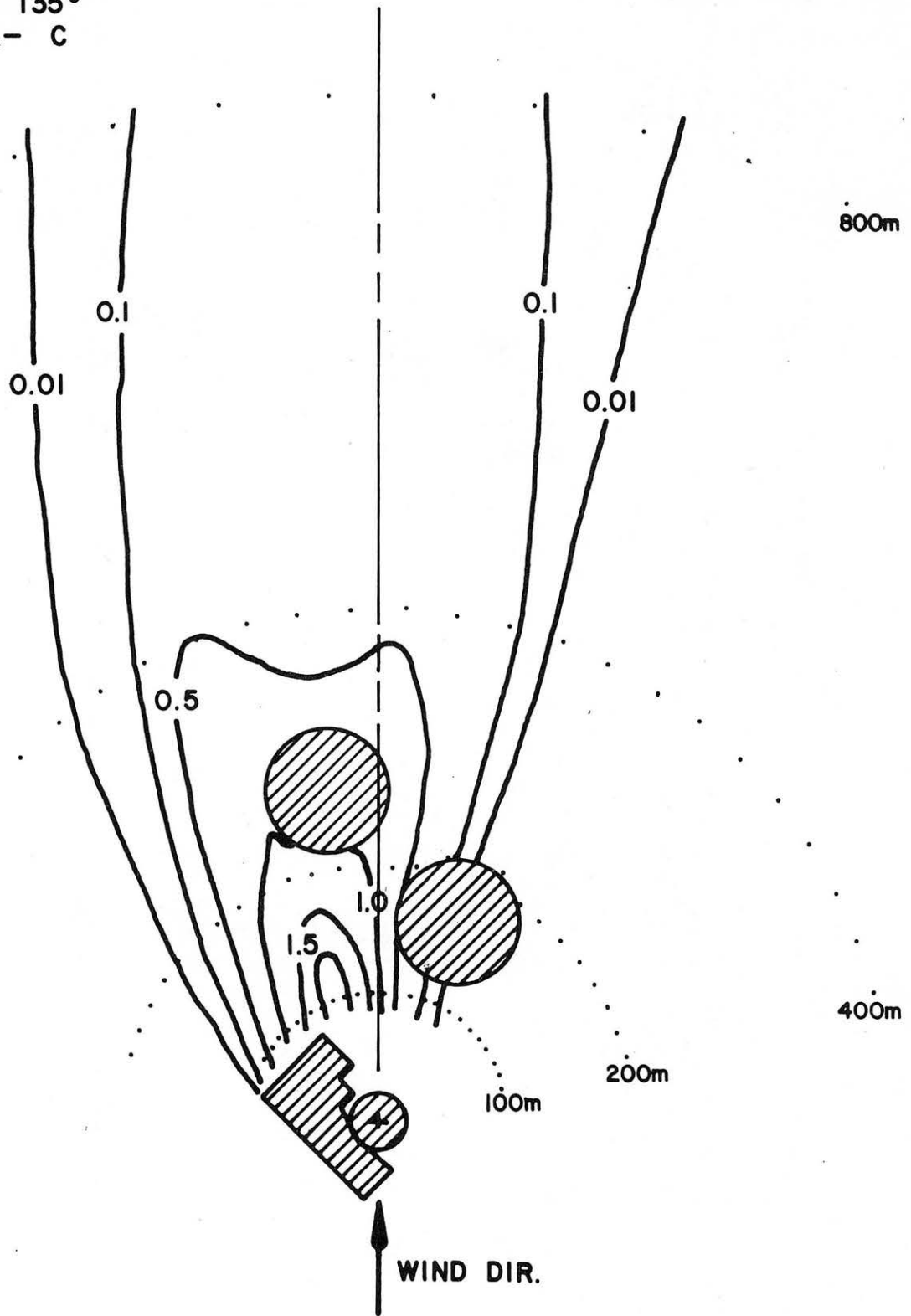

Figure 10.

Concentration Coeff. Isopleths
Stability - Moderately Stable
Wind Dir. - 135°
Release Pt. - C

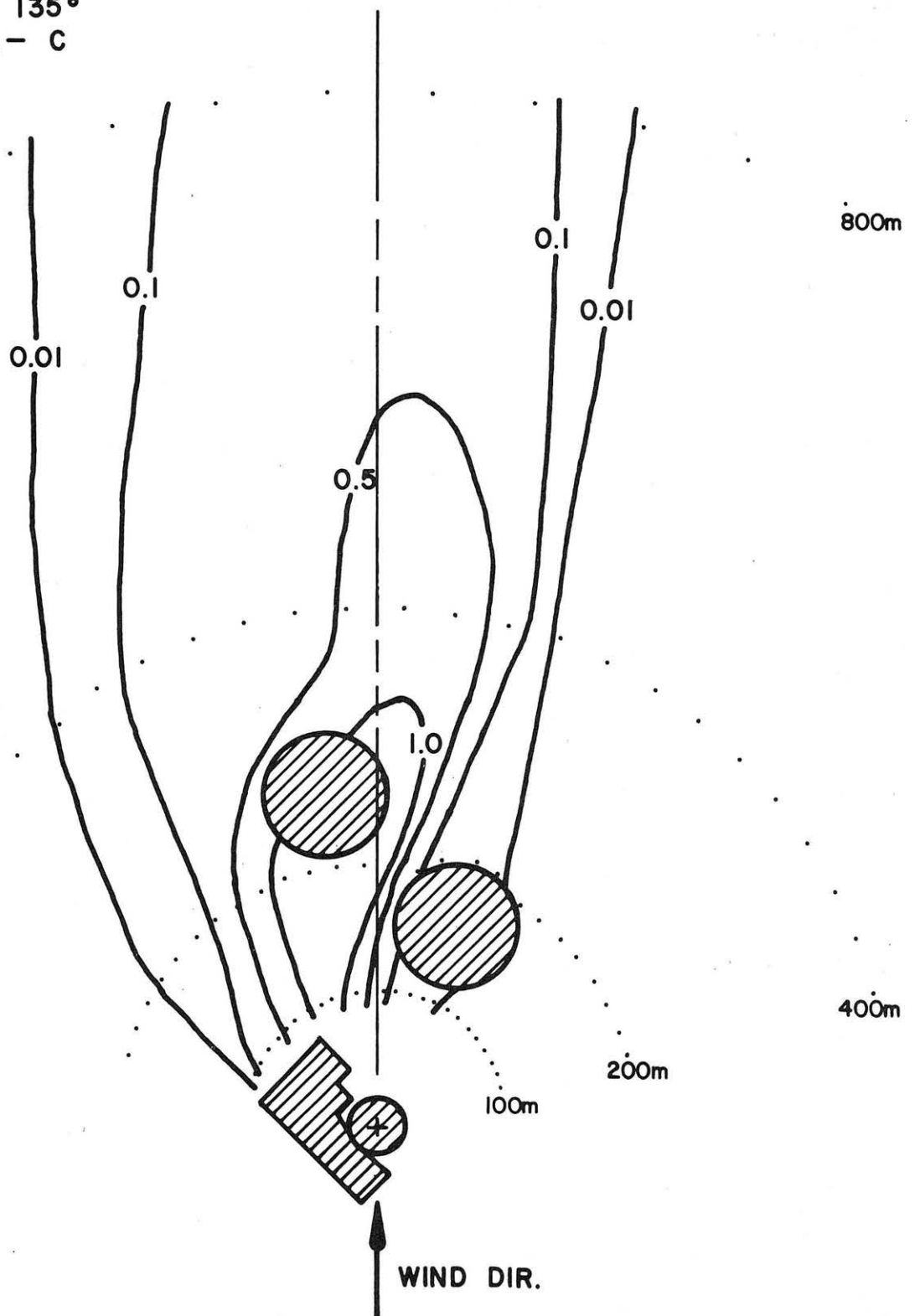

Figure 11.

Concentration Coeff. Isopleths

Stability - Slightly Unstable

Wind Dir. - 135°

Release Pt. - C

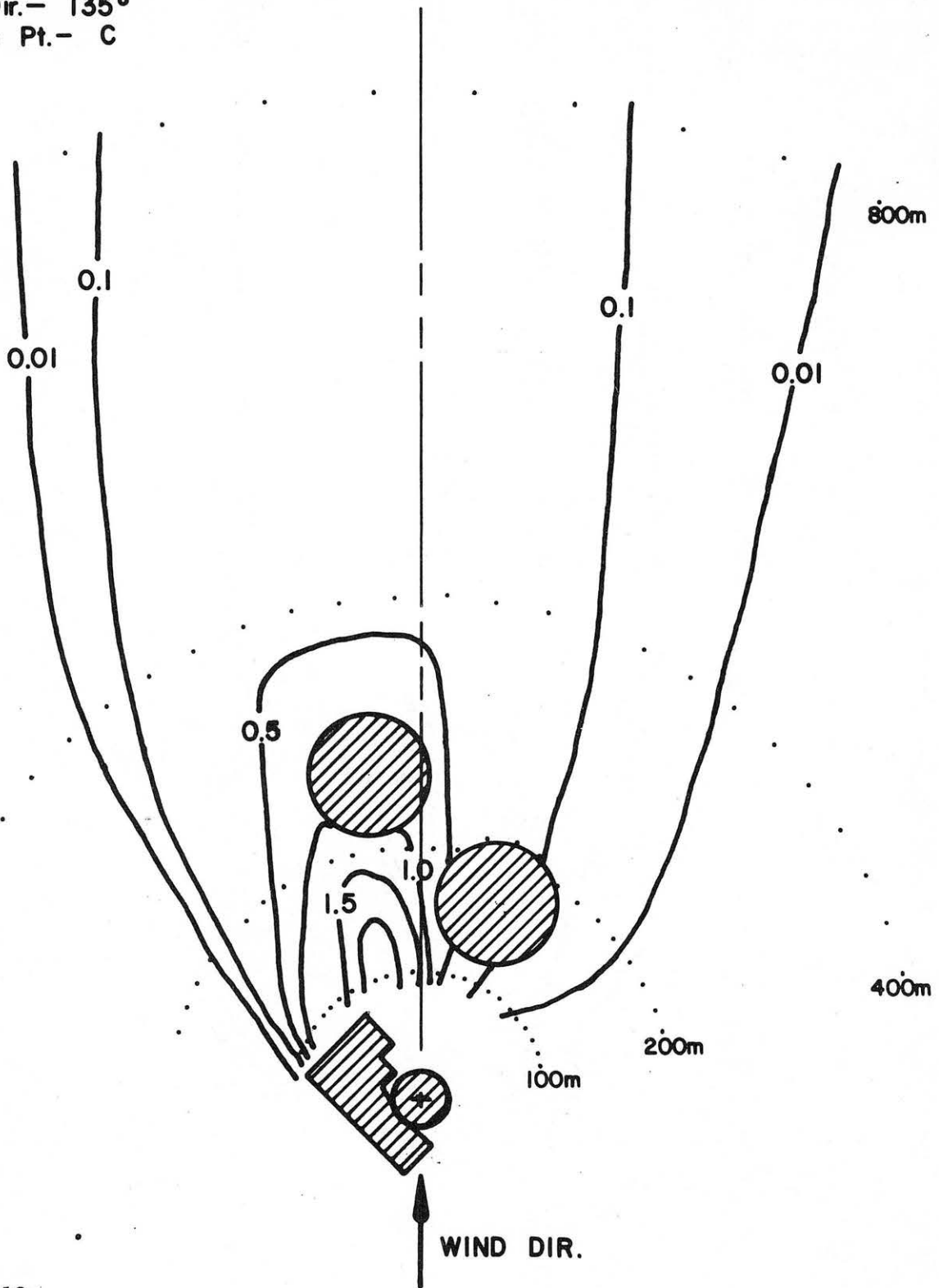

Figure 12.

Concentration Coeff. Isopleths
Stability - Neutral
Wind Dir. - 135°
Release Pt. - G17

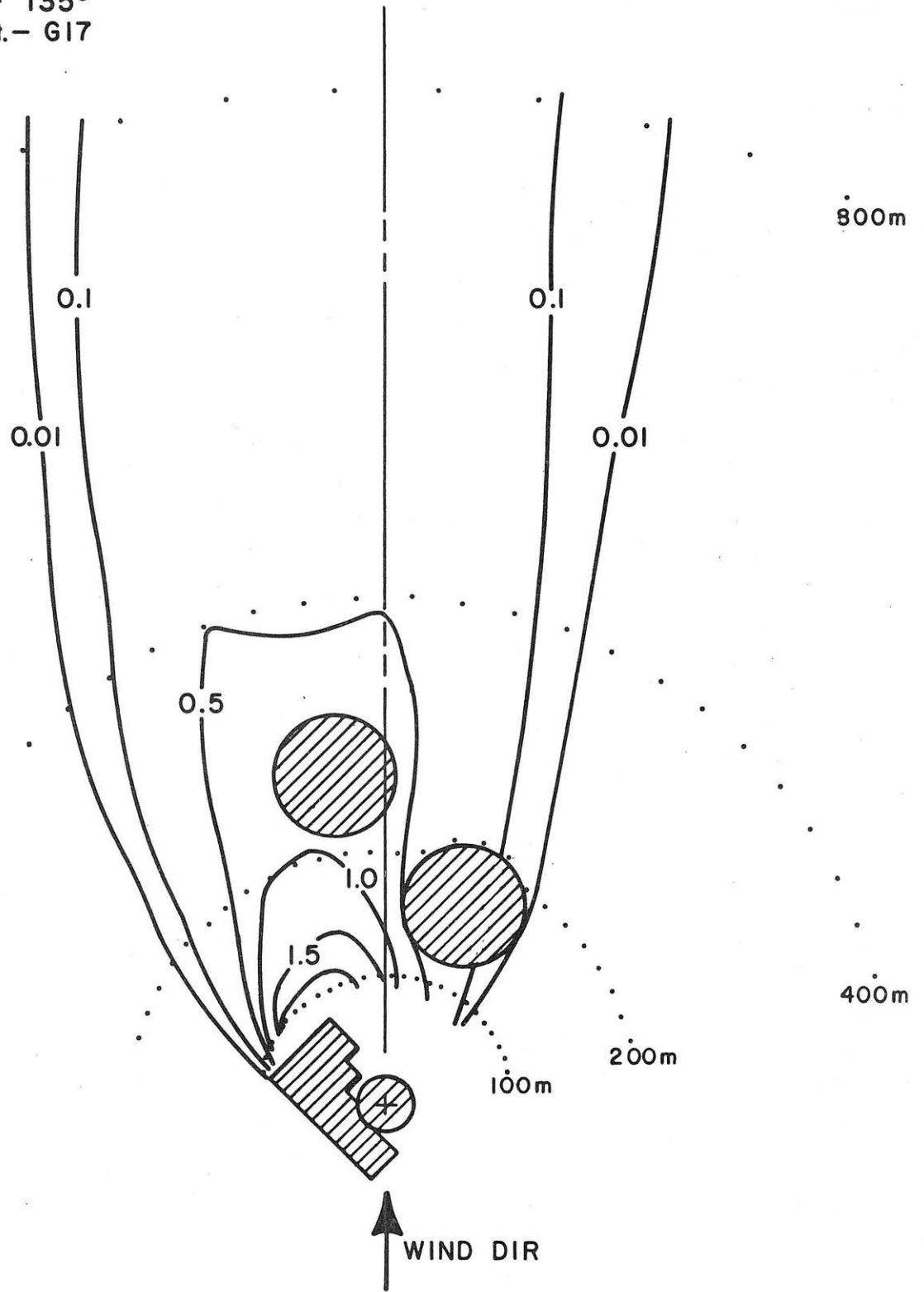

Figure 13.

Concentration Coeff. Isopleths
Stability - Moderately Stable
Wind Dir. - 135°
Release Pt. - G17

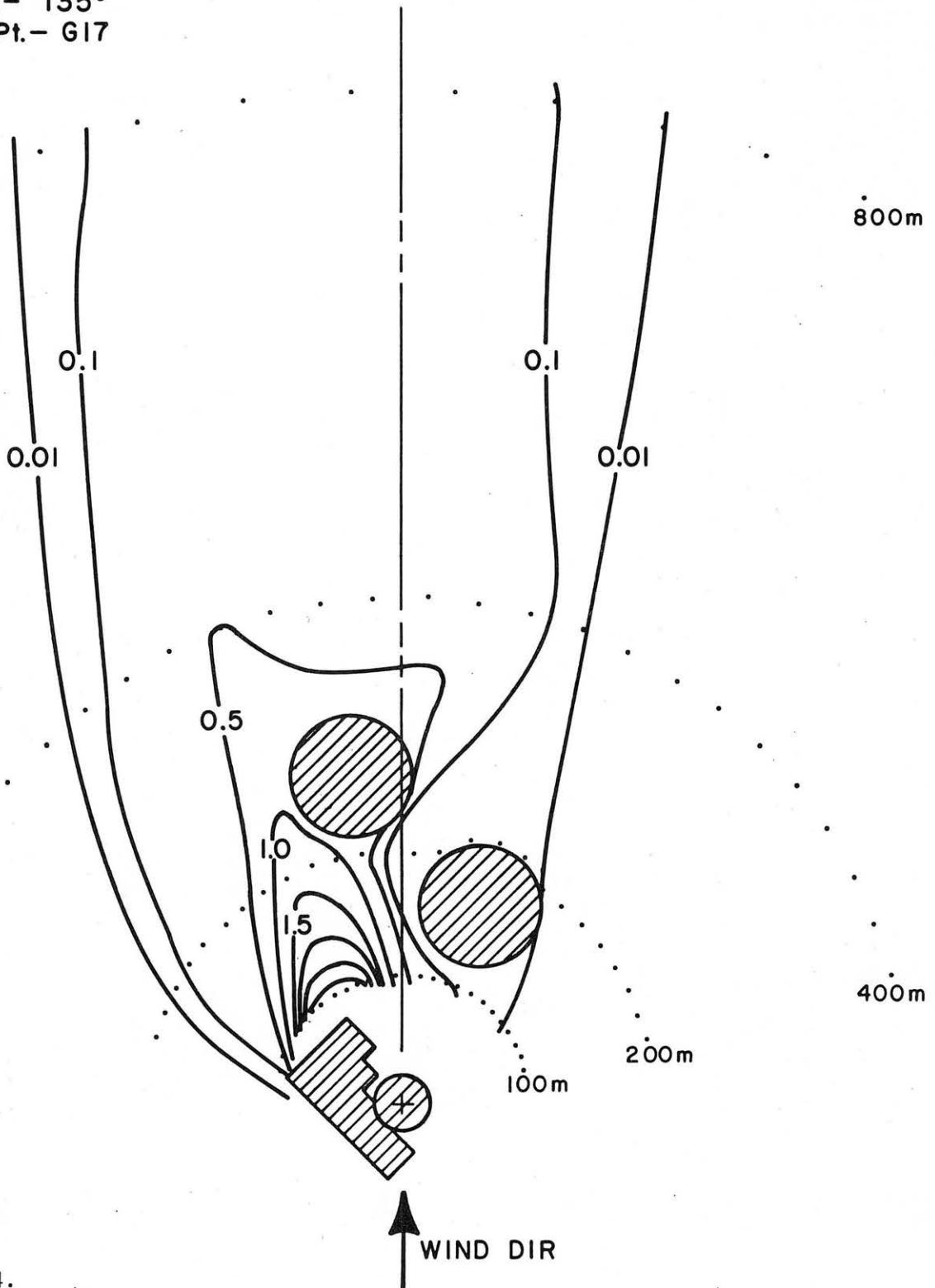

Figure 14.

Concentration Coeff. Isopleths
Stability - Slightly Unstable
Wind Dir. - 135°
Release Pt. - G17

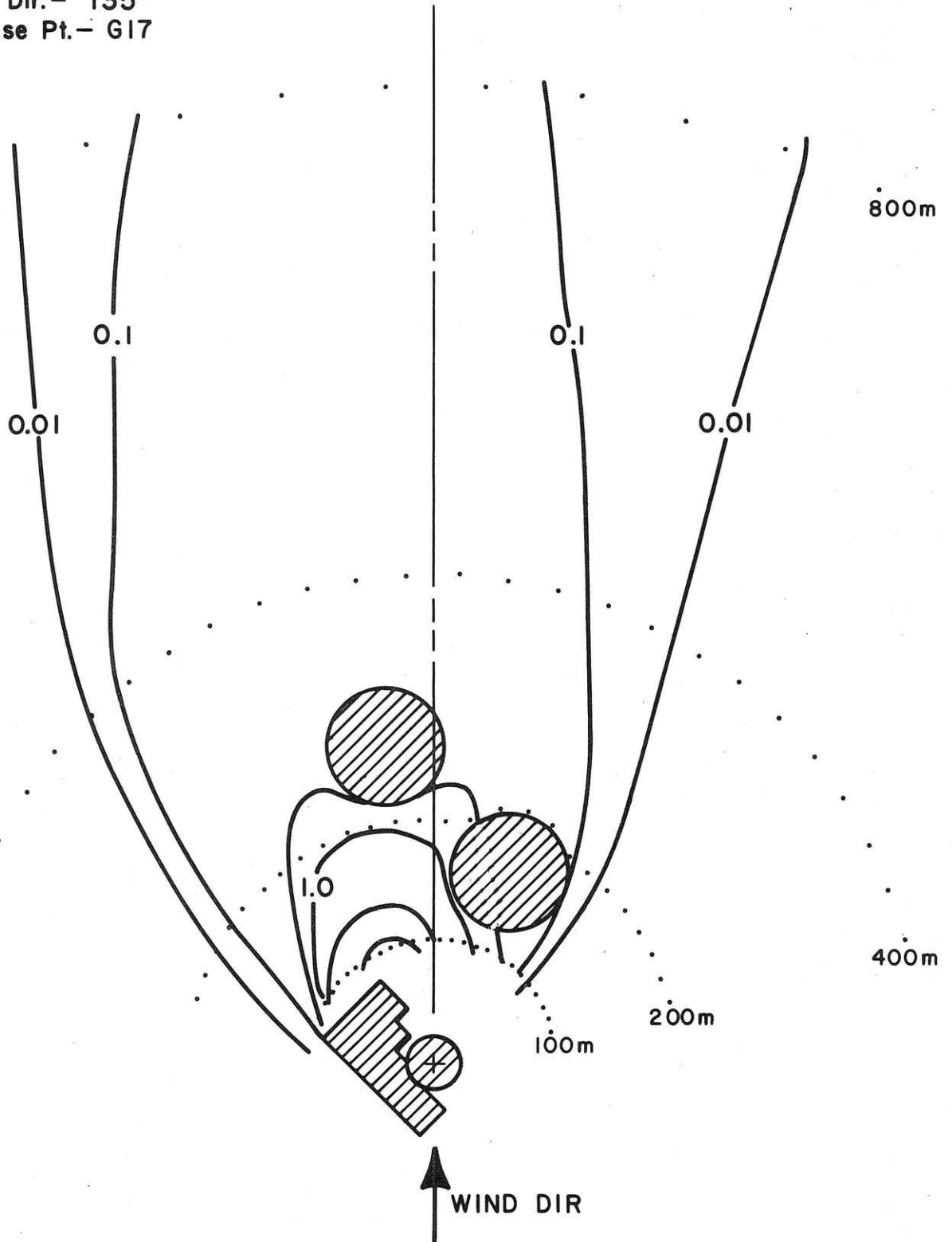

Figure 15.

Concentration Coeff. Isopleths

Stability - Neutral

Wind Dir. - 225°

Release Pt. - C

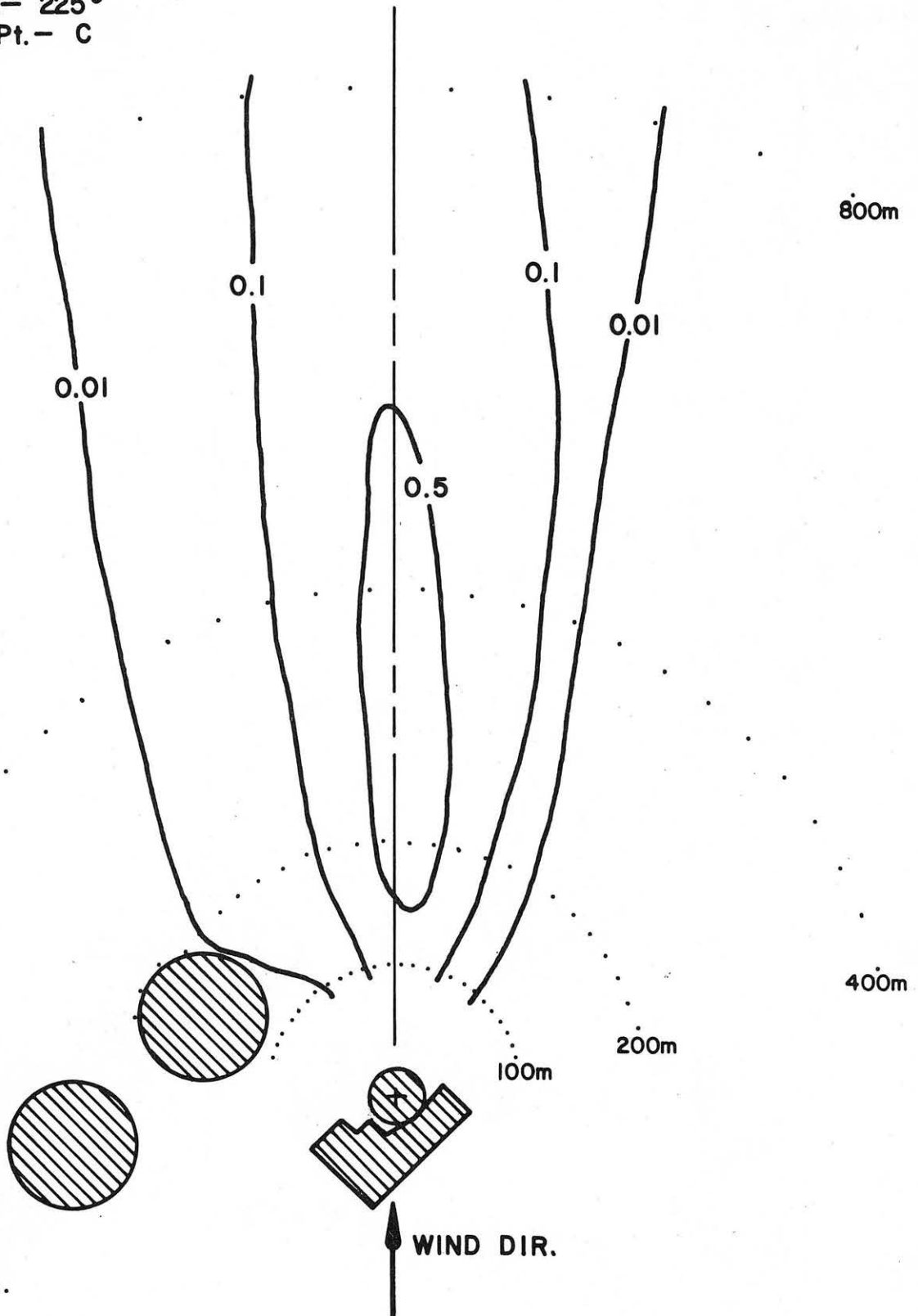

Figure 16.

Concentration Coeff. Isopleths
Stability - Moderately Stable
Wind Dir - 225°
Release Pt. - C

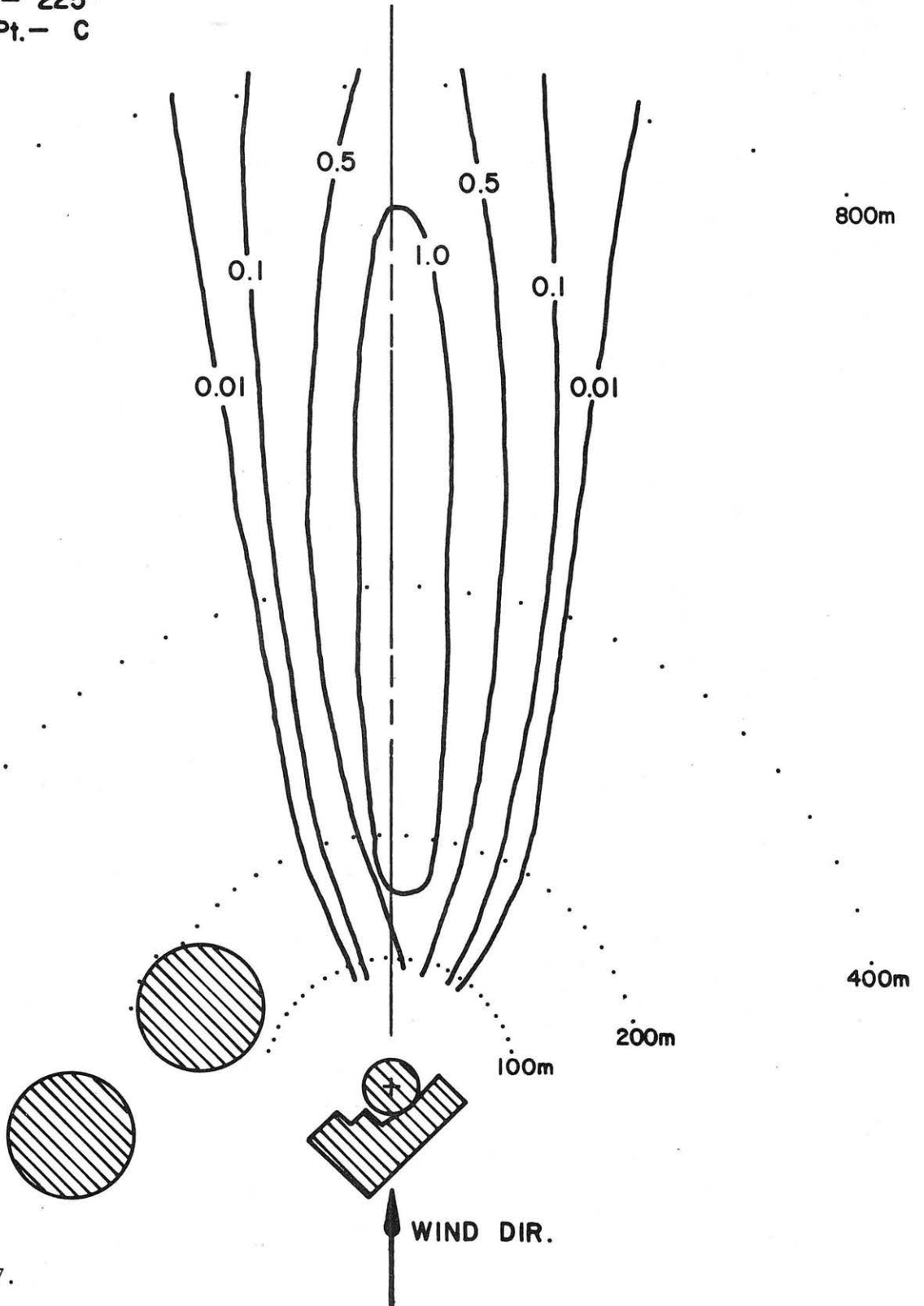

Figure 17.

Concentration Coeff. Isopleths
Stability - Slightly Unstable
Wind Dir. - 225°
Release Pt. - C

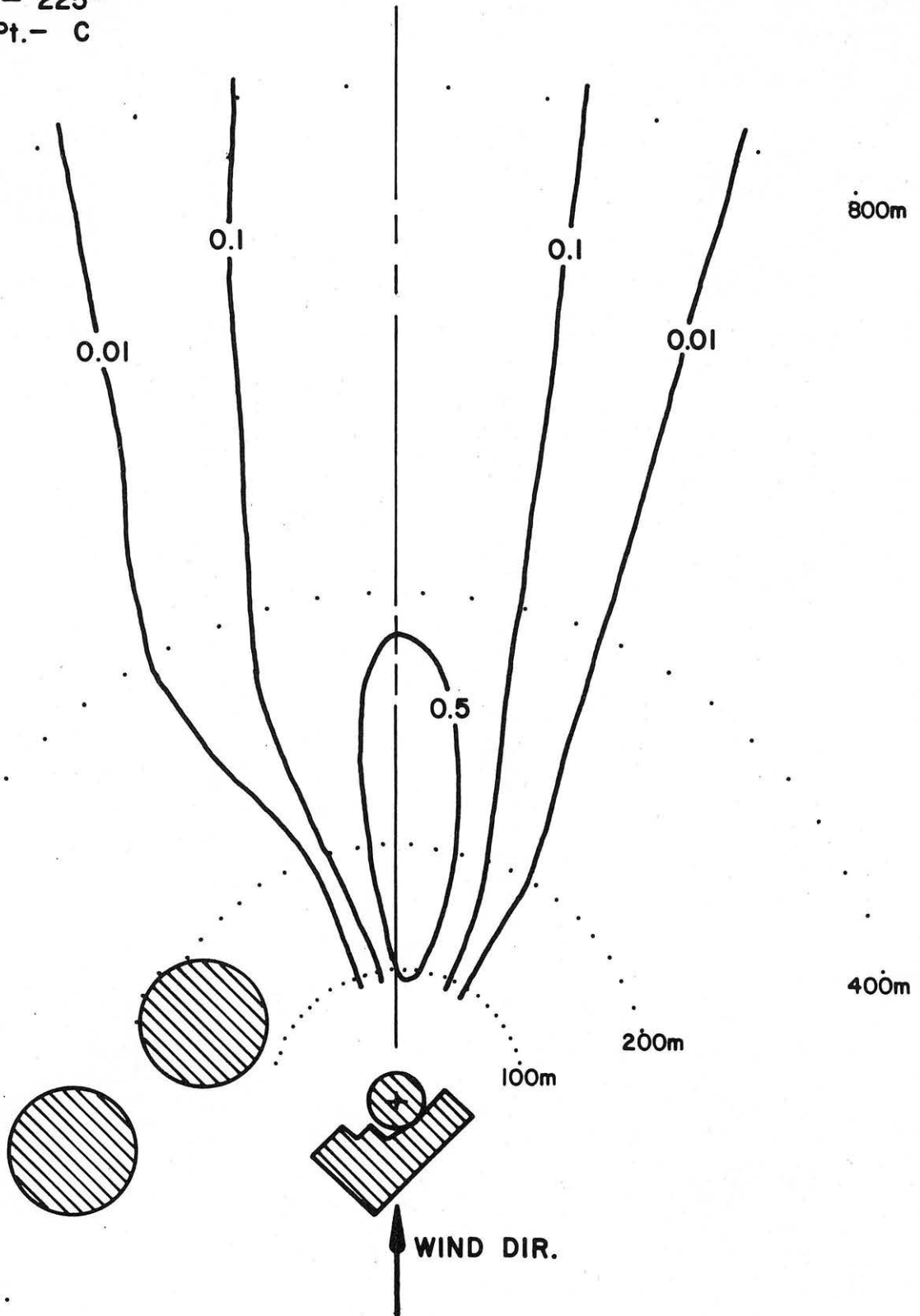

Figure 18.

Concentration Coeff. Isopleths
Stability - Neutral
Wind Dir. - 225°
Release Pt. - G17

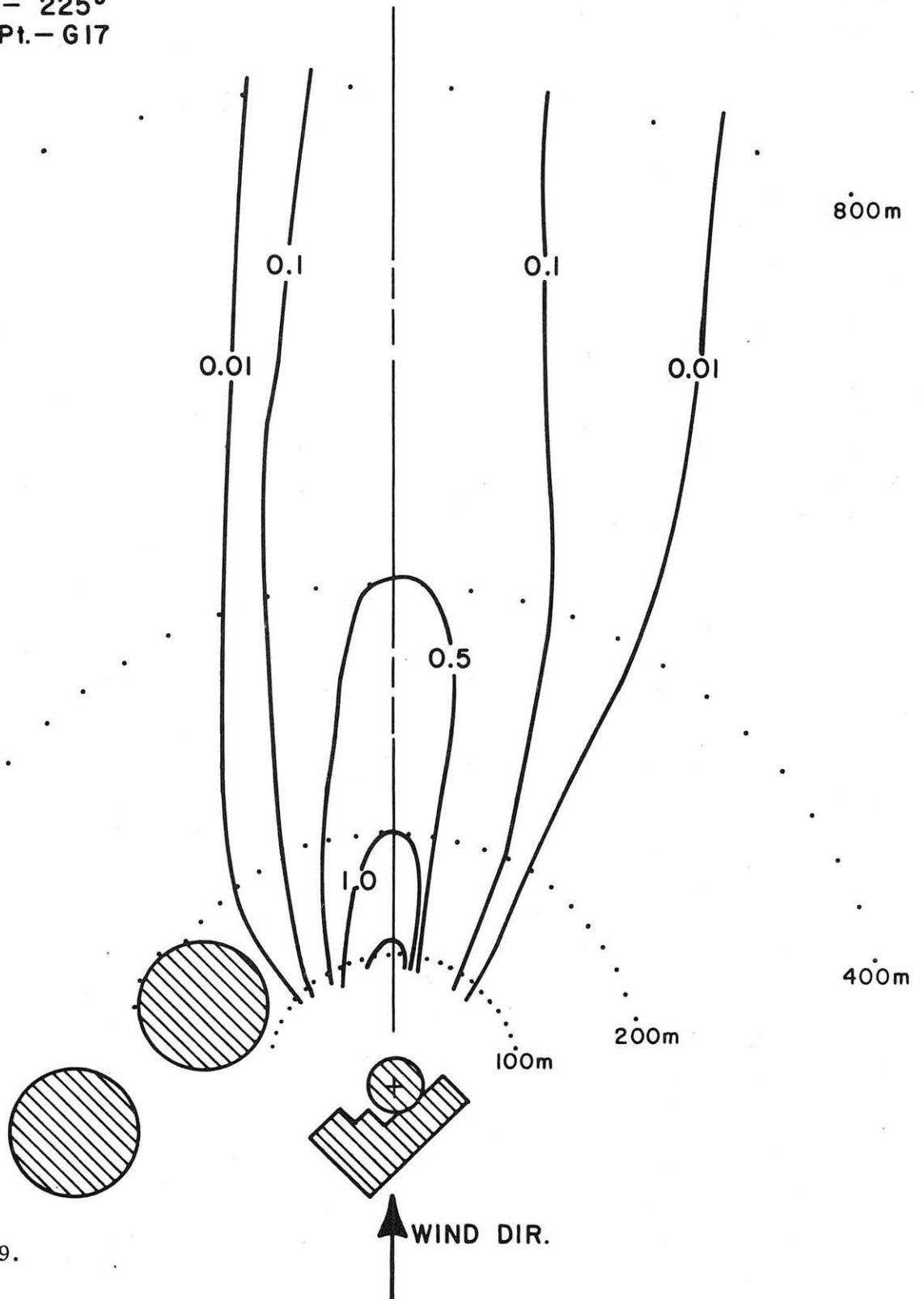

Figure 19.

Concentration Coeff. Isopleths
Stability - Moderately Stable
Wind Dir. - 225°
Release Pt. - G17

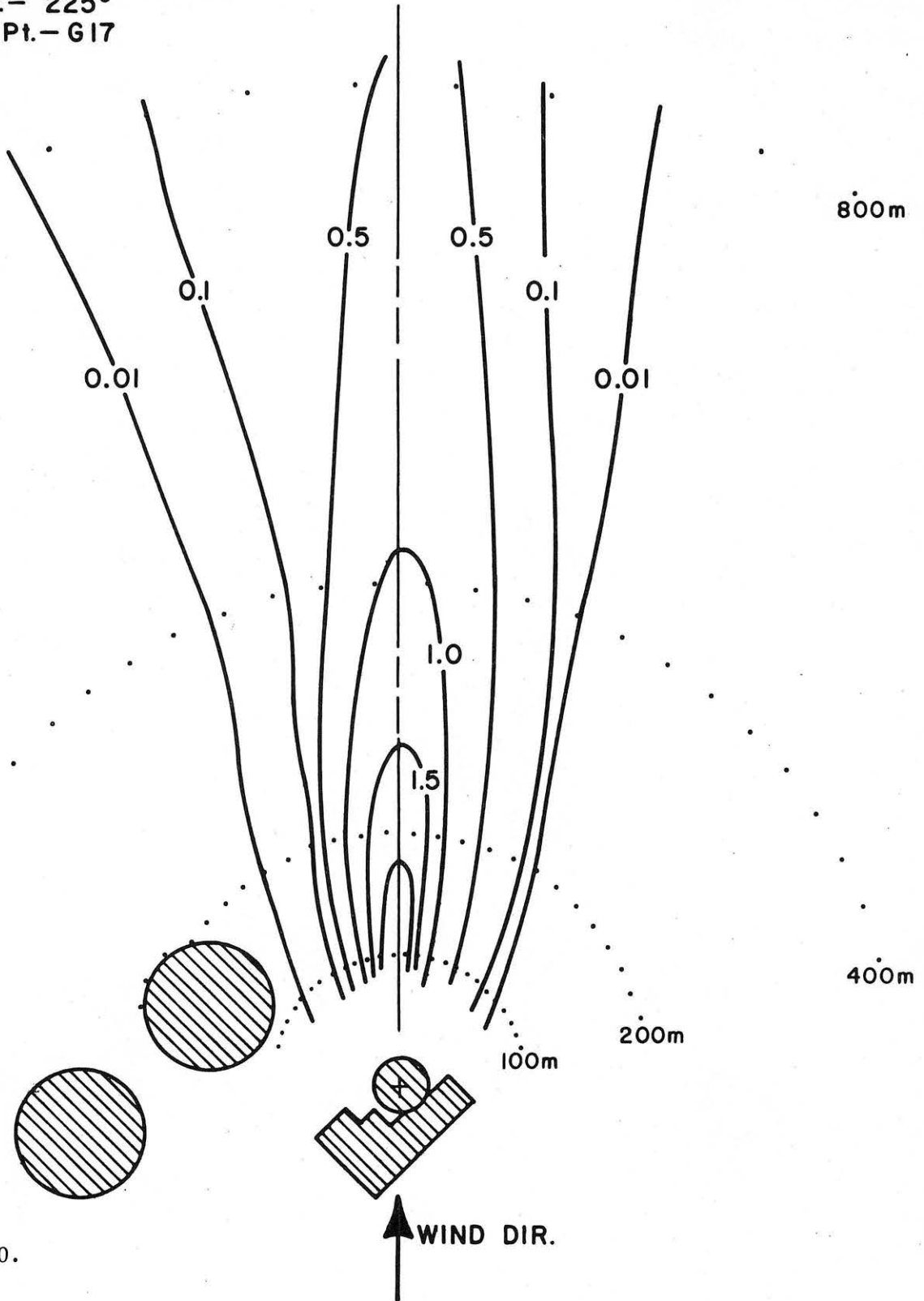

Figure 20.

Concentration Coeff. Isopleths
Stability - Slightly Unstable
Wind Dir. - 225°
Release Pt. - G17

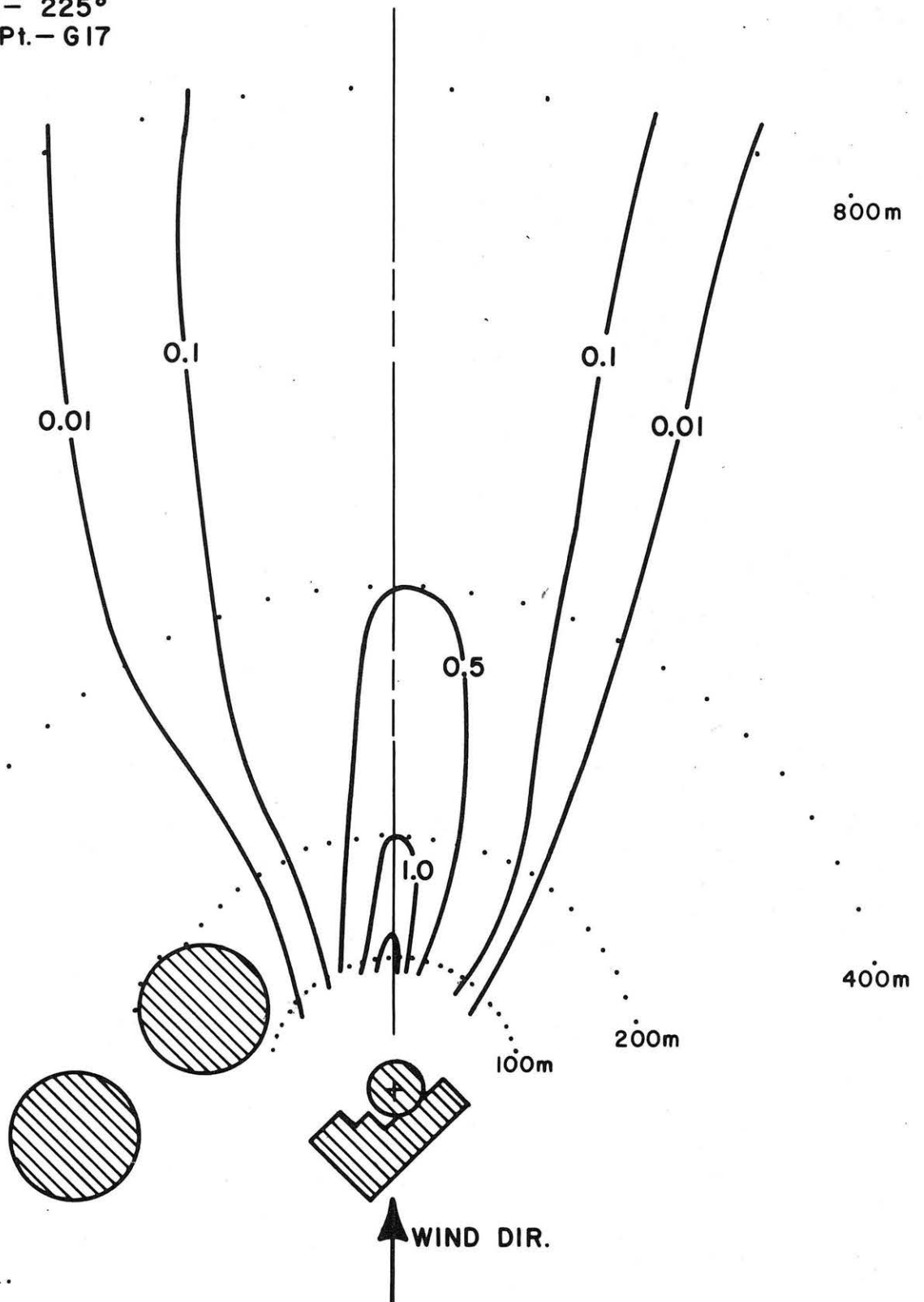

Figure 21.

Concentration Coeff. Isopleths

Stability - Neutral

Wind Dir. - 315°

Release Pt. - C

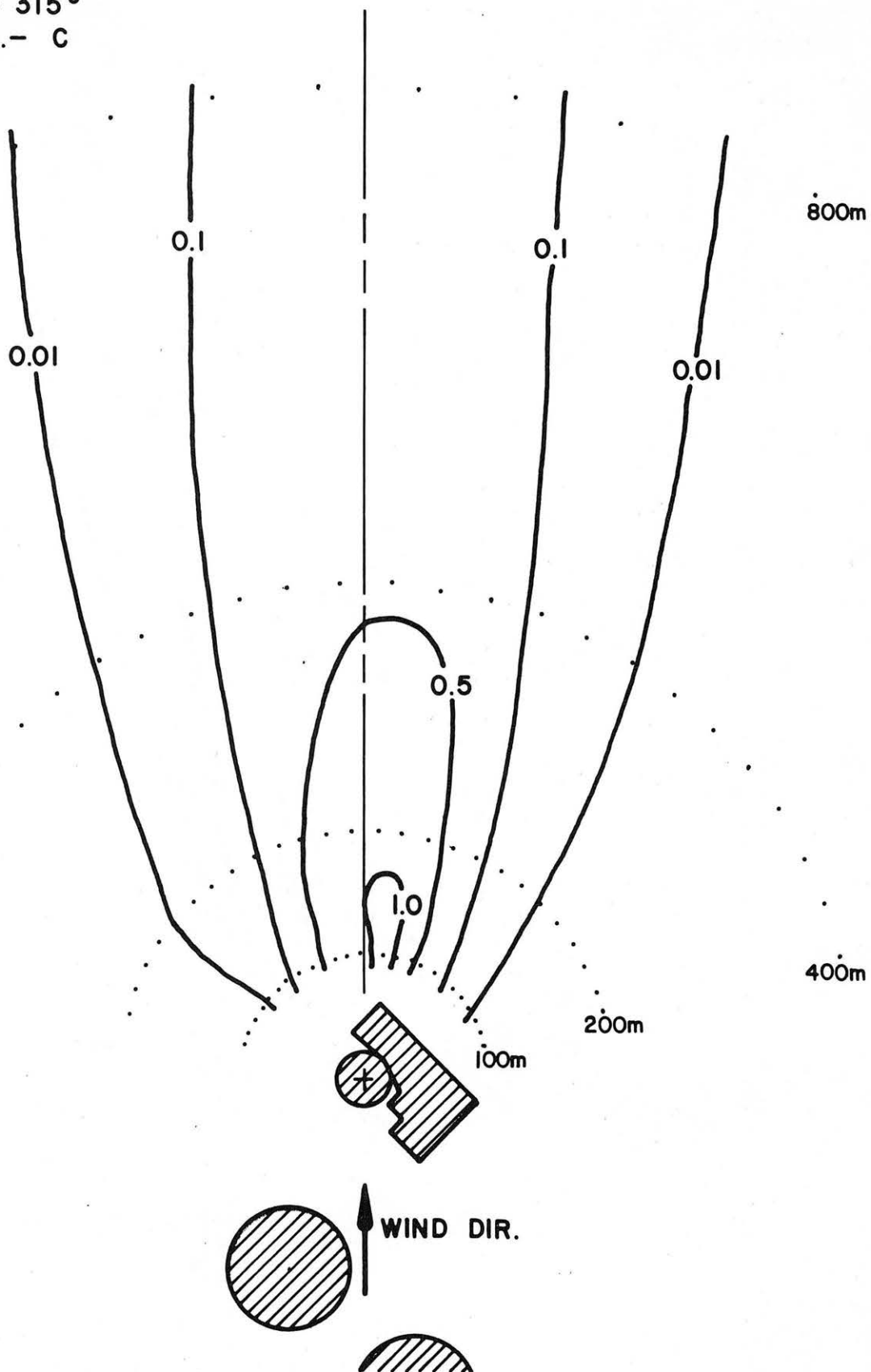

Figure 22.

Concentration Coeff. Isopleths
Stability— Moderately Stable
Wind Dir.— 315°
Release Pt.— C

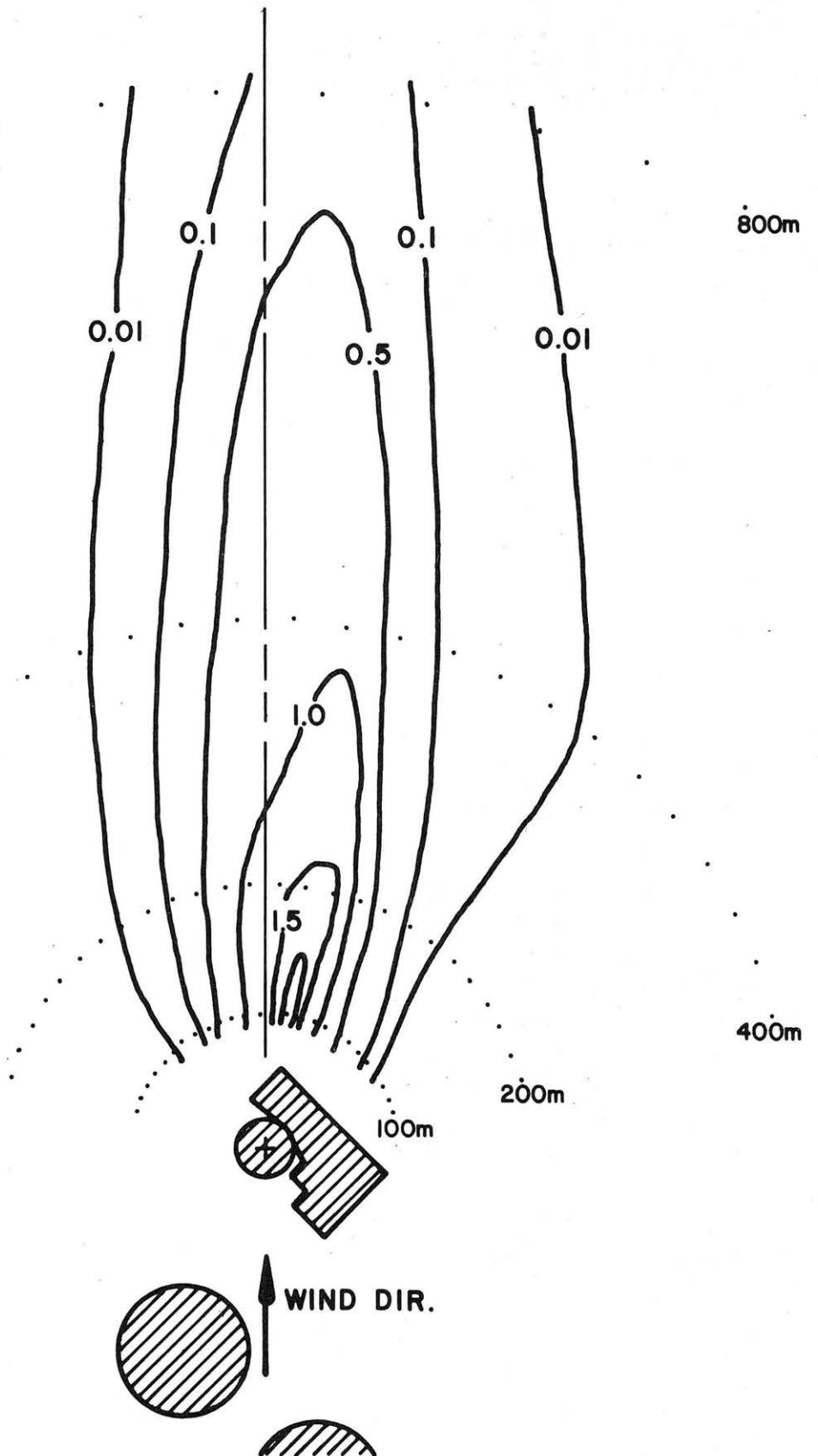

Figure 23.

Concentration Coeff. Isopleths
Stability— Slightly Unstable
Wind Dir.— 315°
Release Pt.— C

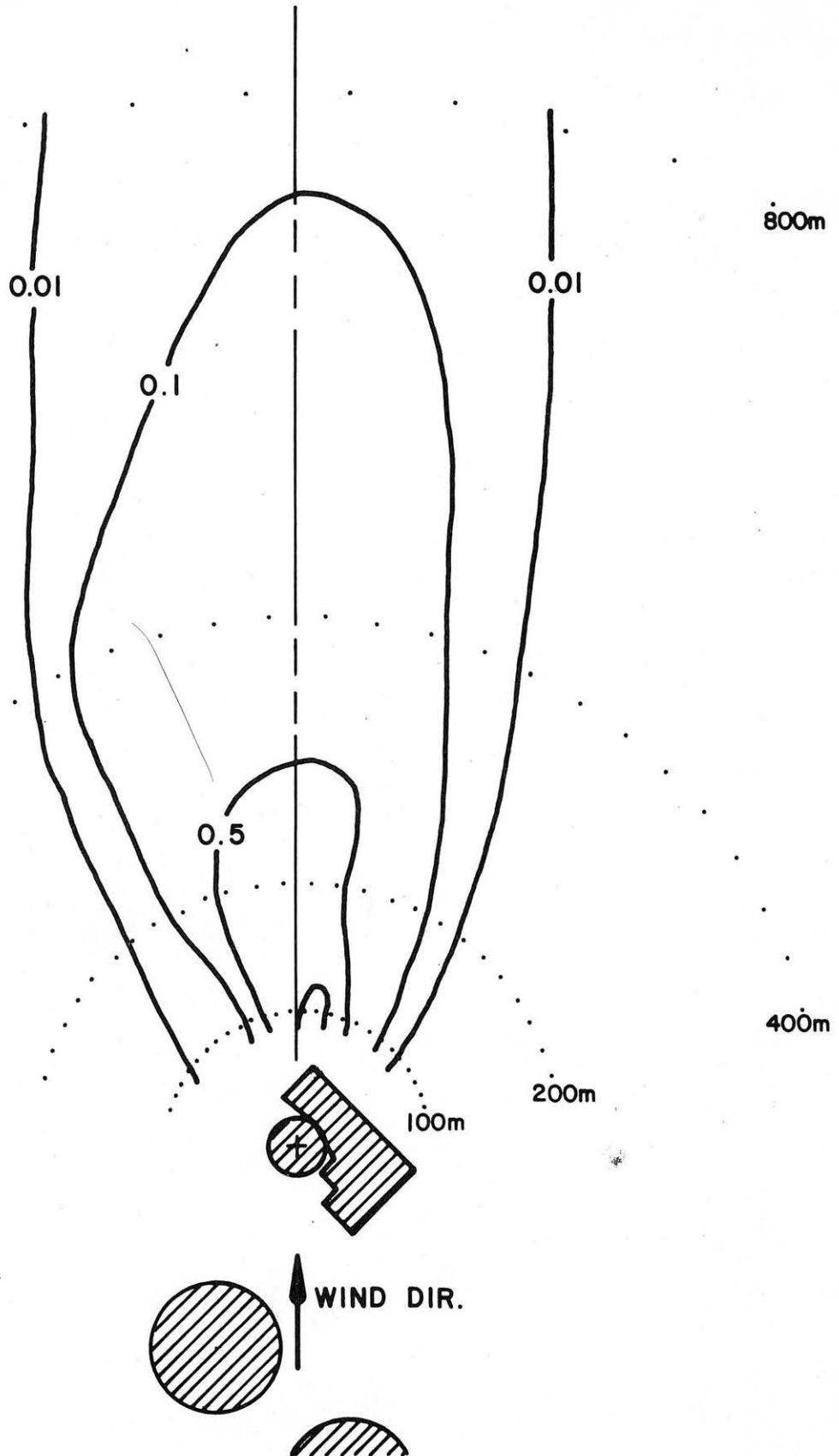

Figure 24.

Concentration Coeff. Isopleths
Stability - Neutral
Wind Dir. - 315°
Release Pt. - G17

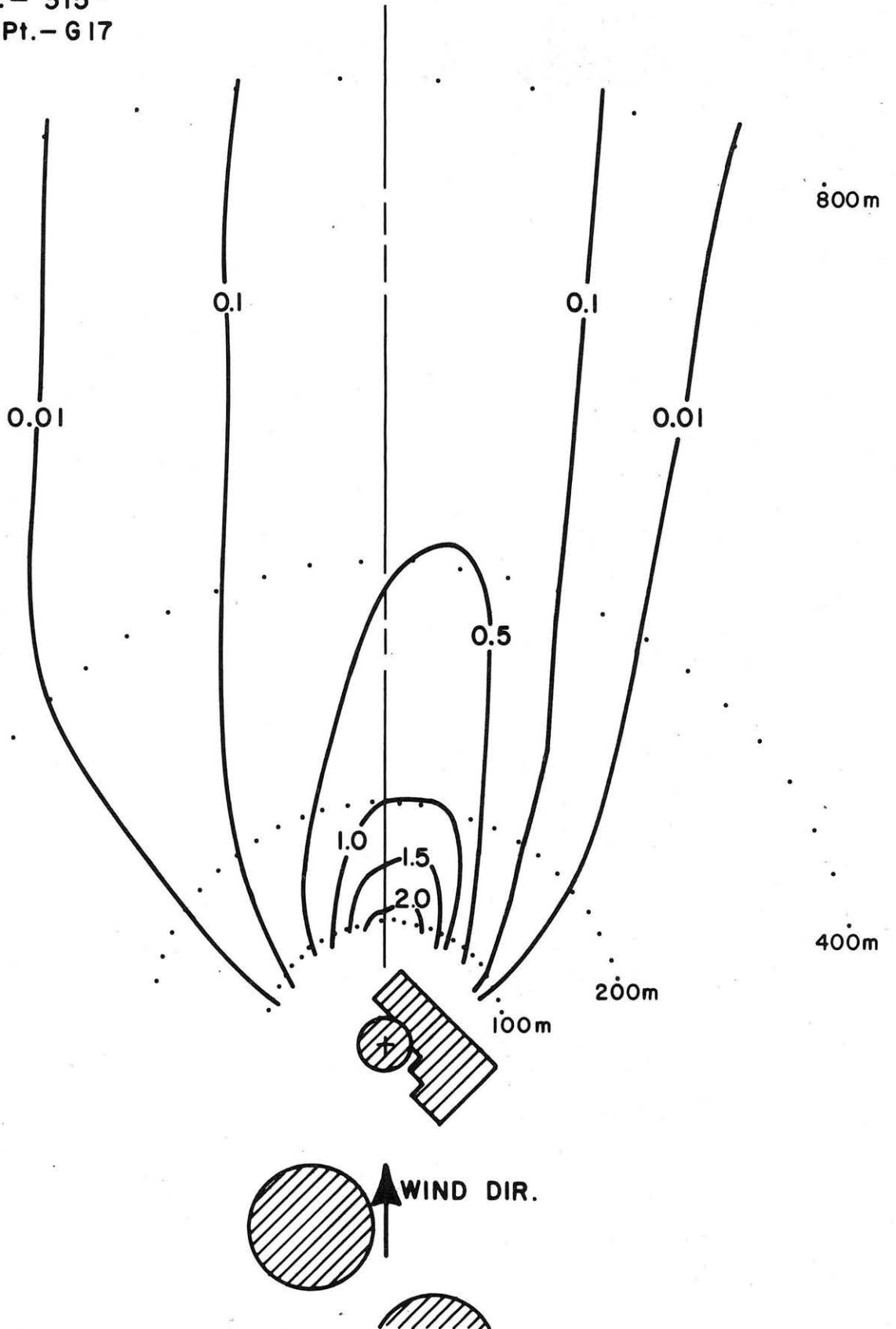

Figure 25.

Concentration Coeff. Isopleths
Stability - Moderately Stable
Wind Dir. - 315°
Release Pt. - G17

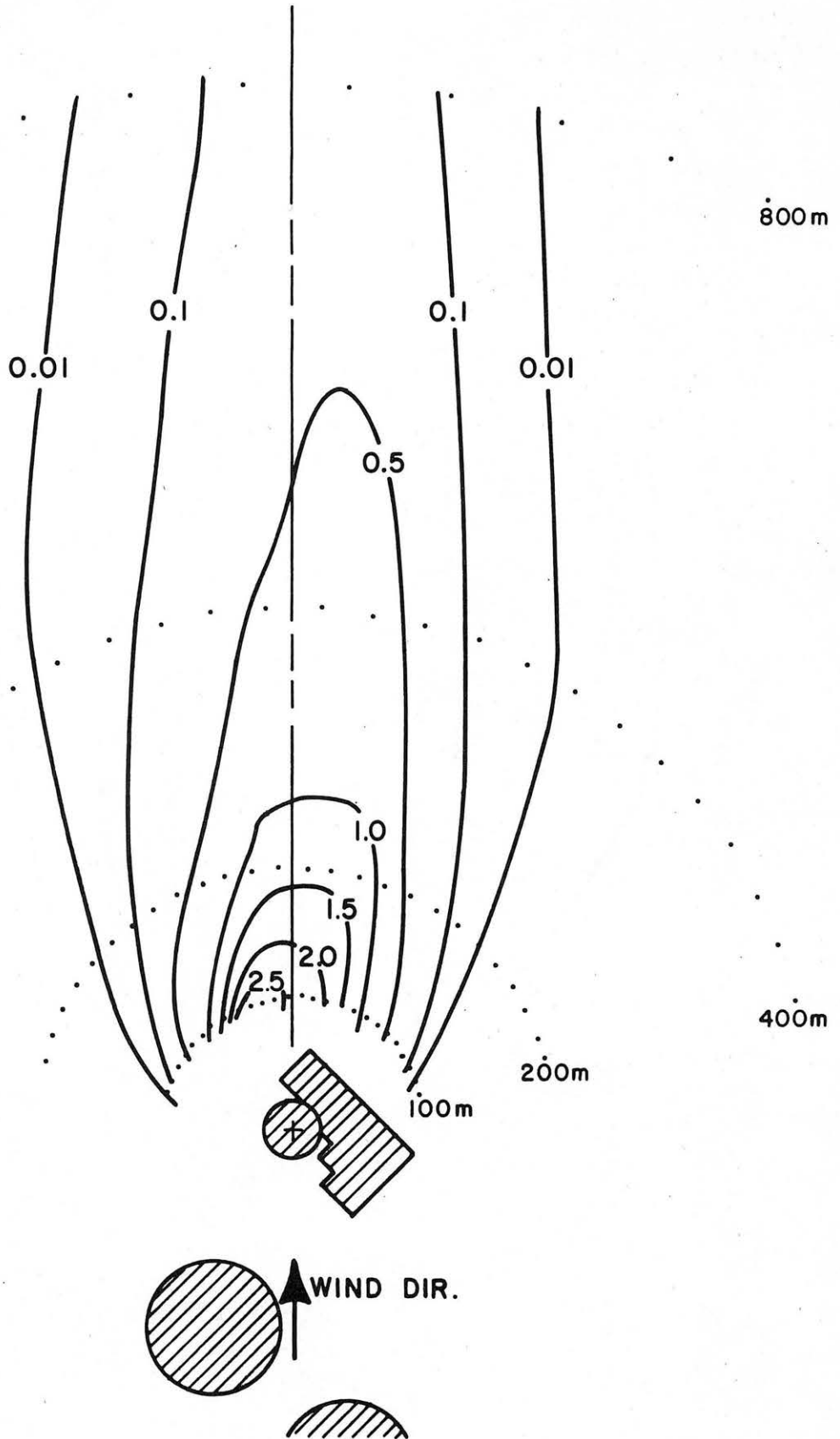

Figure 26.

Concentration Coeff. Isopleths
Stability - Slightly Unstable
Wind Dir. - 315°
Release Pt. - G17

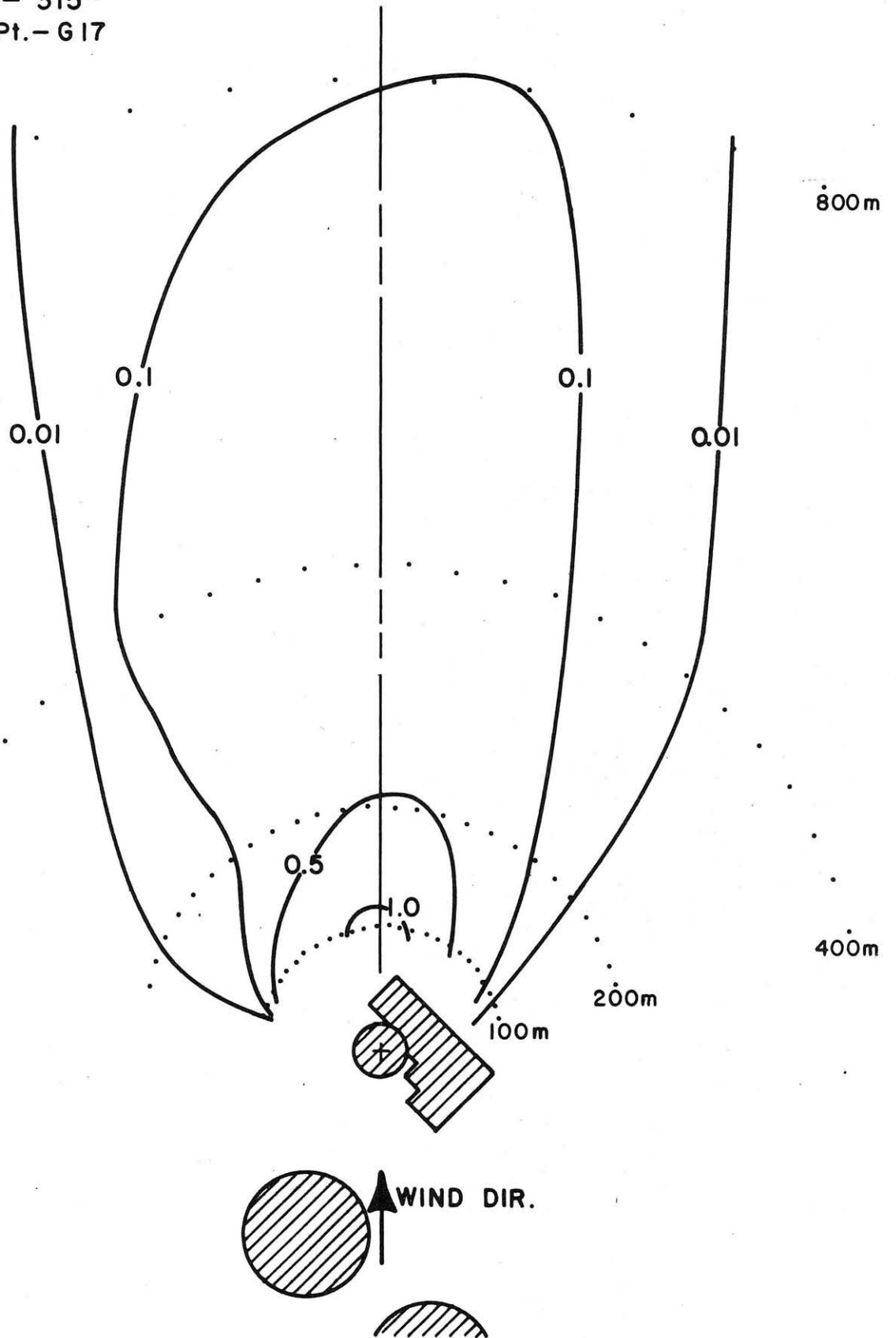

Figure 27.

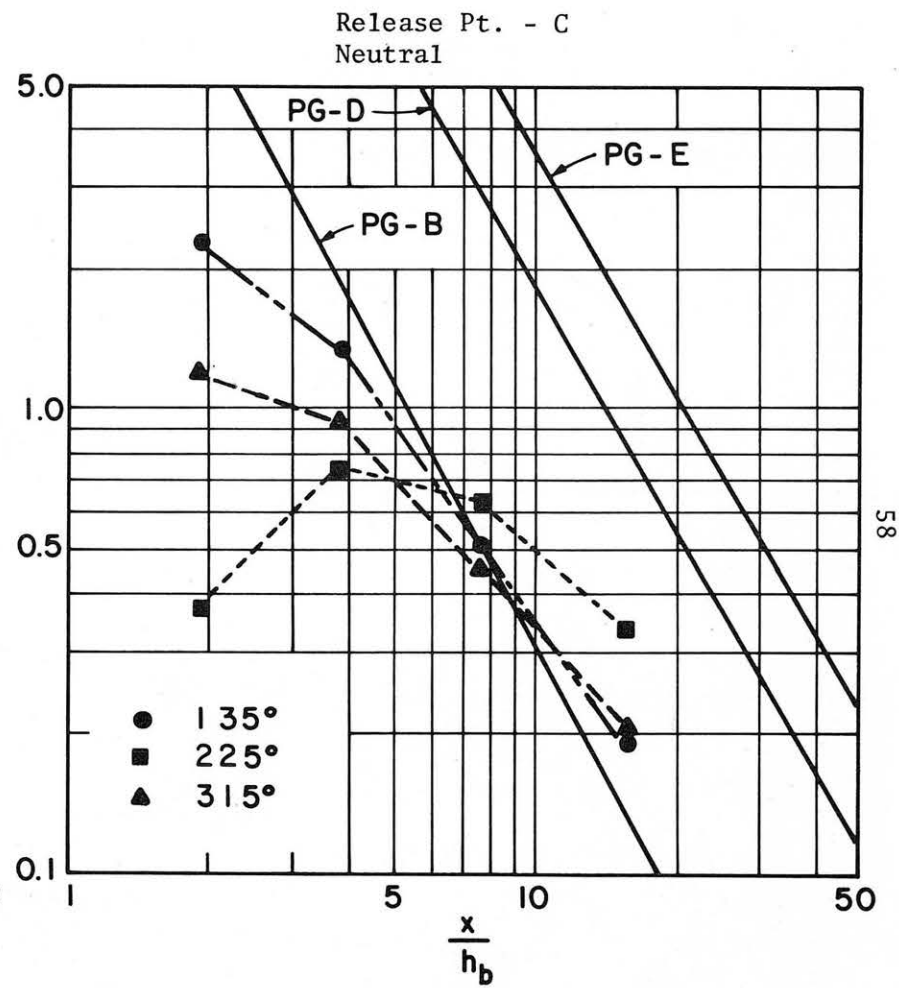
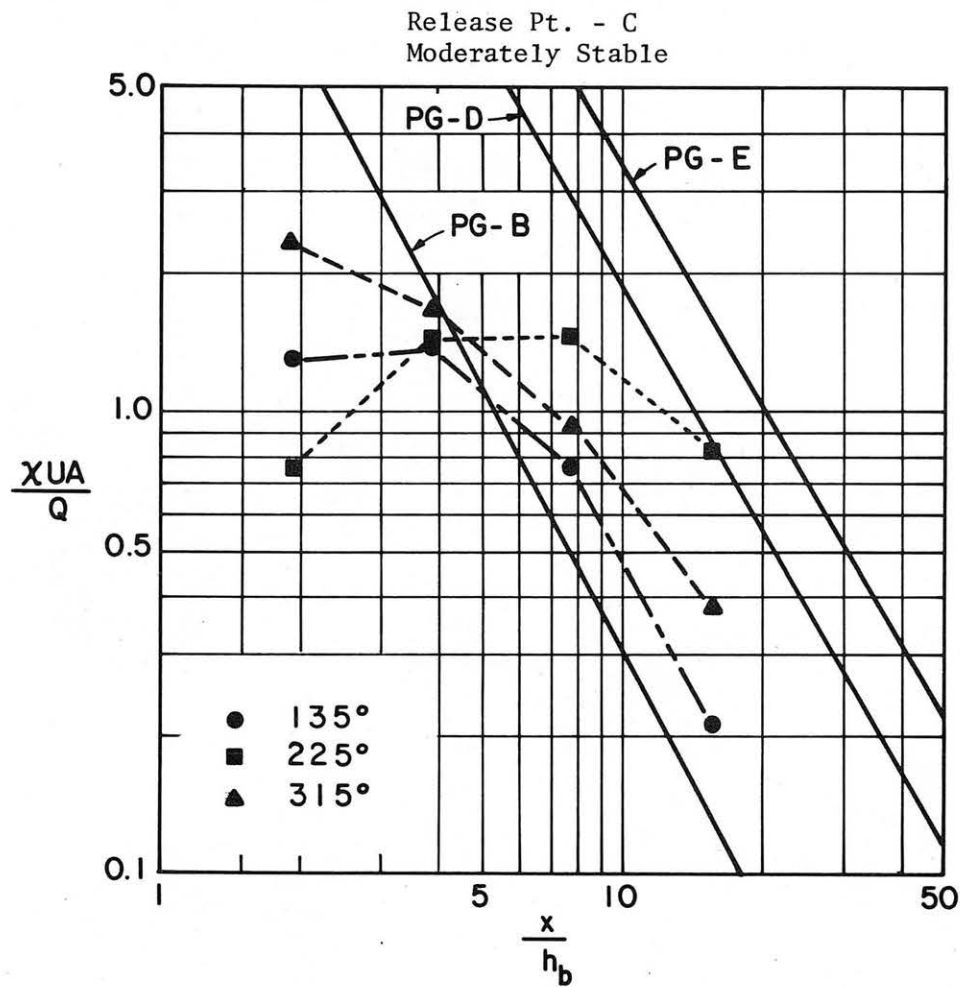

Figure 28. Plot of Maximum K_c Versus x/h_b for Release Point C

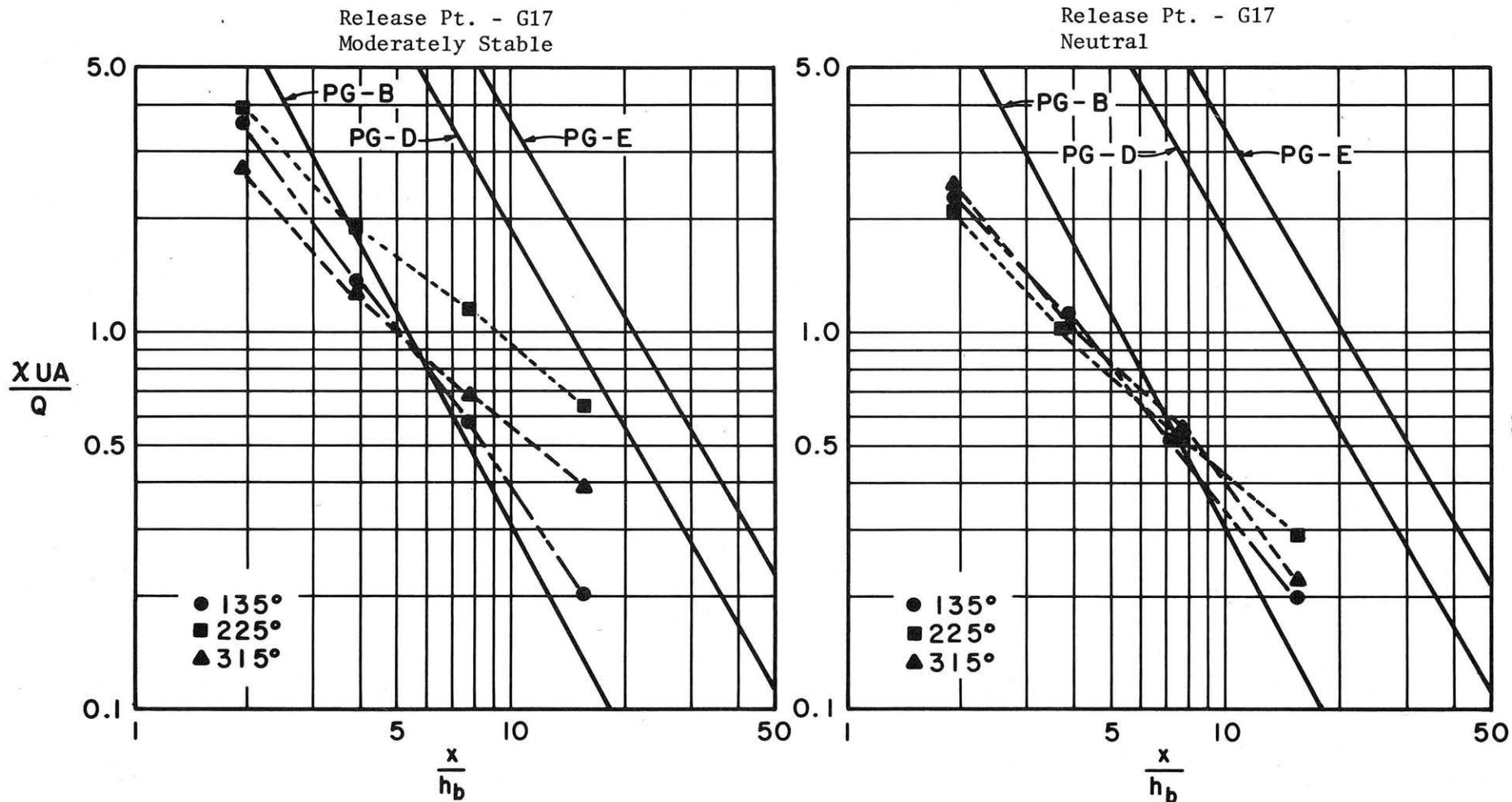
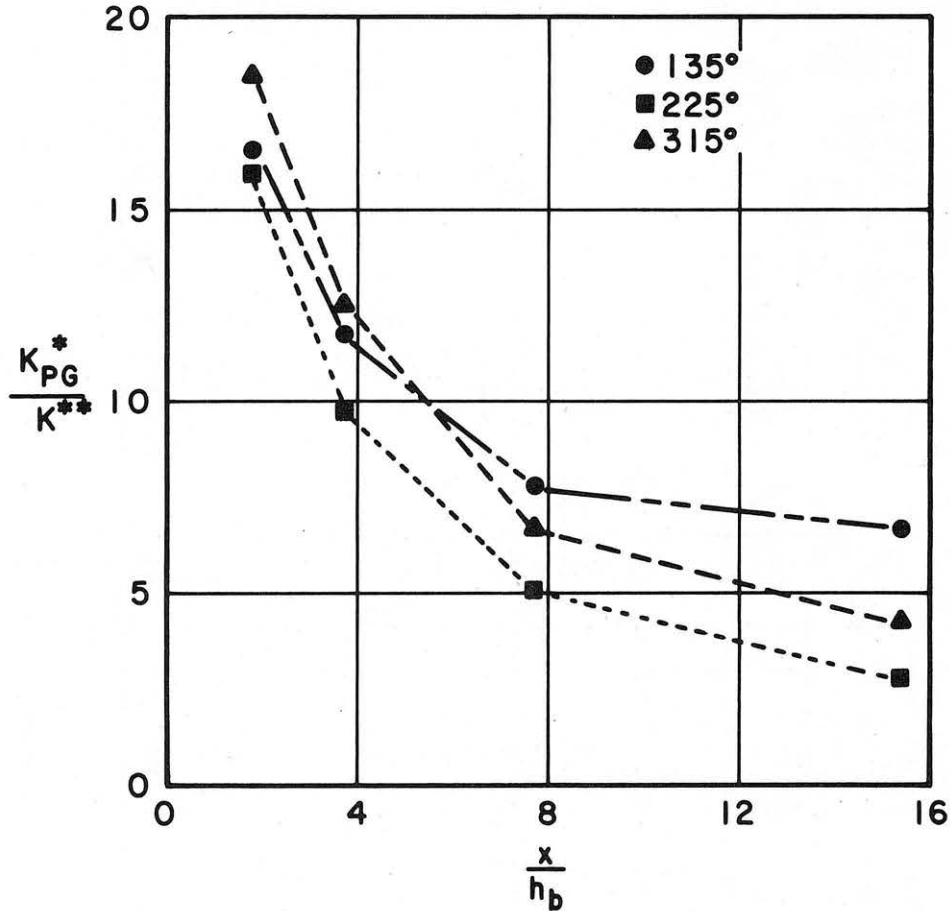

Figure 29. Plot of Maximum K_c Versus x/h_b for Release Point G17.



$$* K_{PG} = \frac{A}{\pi \sigma_y \sigma_z}, \quad A = 1.5 h_b^2$$

** Observations for each Wind Direction are Average of Moderately Stable and Neutral Cases.

Figure 30. Plot of Ratio of Ground Level Centerline K_c from the Gaussian Diffusion Equation to Maximum Observed Ground Level K_c Versus x/h_b for G17 Release.

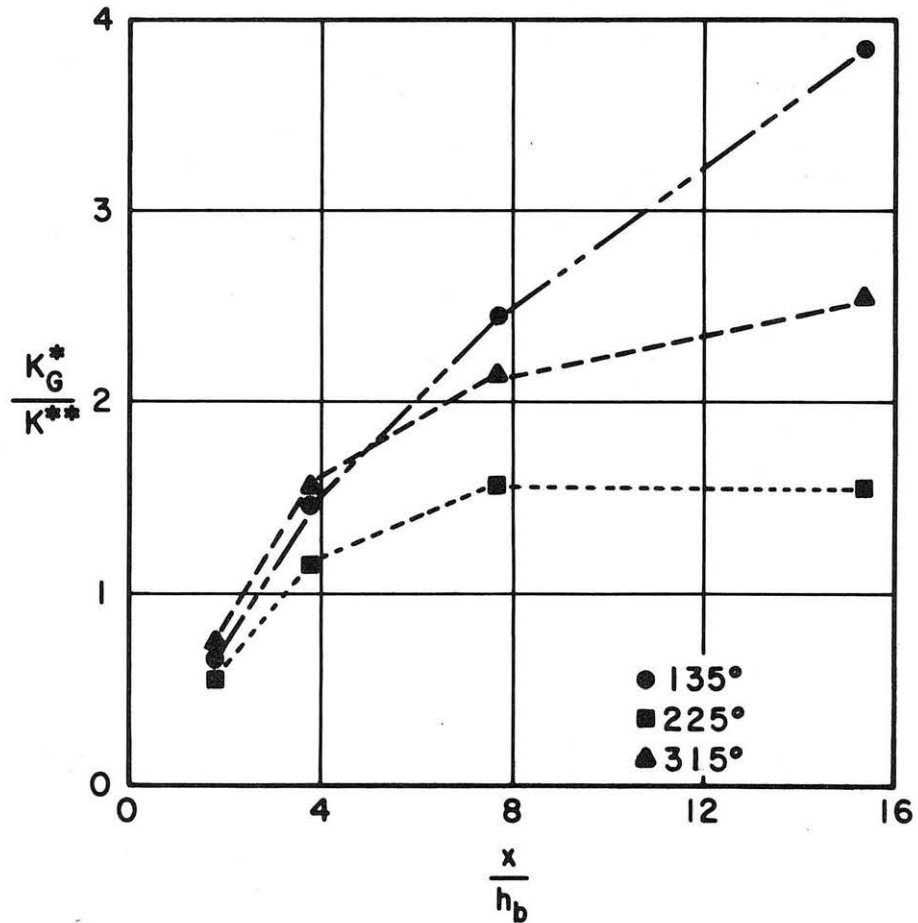

$$* K_G = \frac{A}{\pi \sigma_y \sigma_z + CA}, \quad A = 1.5 h_b^2, \quad C = 0.5$$

** Observations for each Wind Direction are Average of Moderately Stable and Neutral Cases.

Figure 31. Plot of Ratio of Ground Level Centerline K_C From the Gaussian Diffusion Equation Modified by Gifford to Maximum Observed Ground Level K_C Versus x/h_b for G17 Release

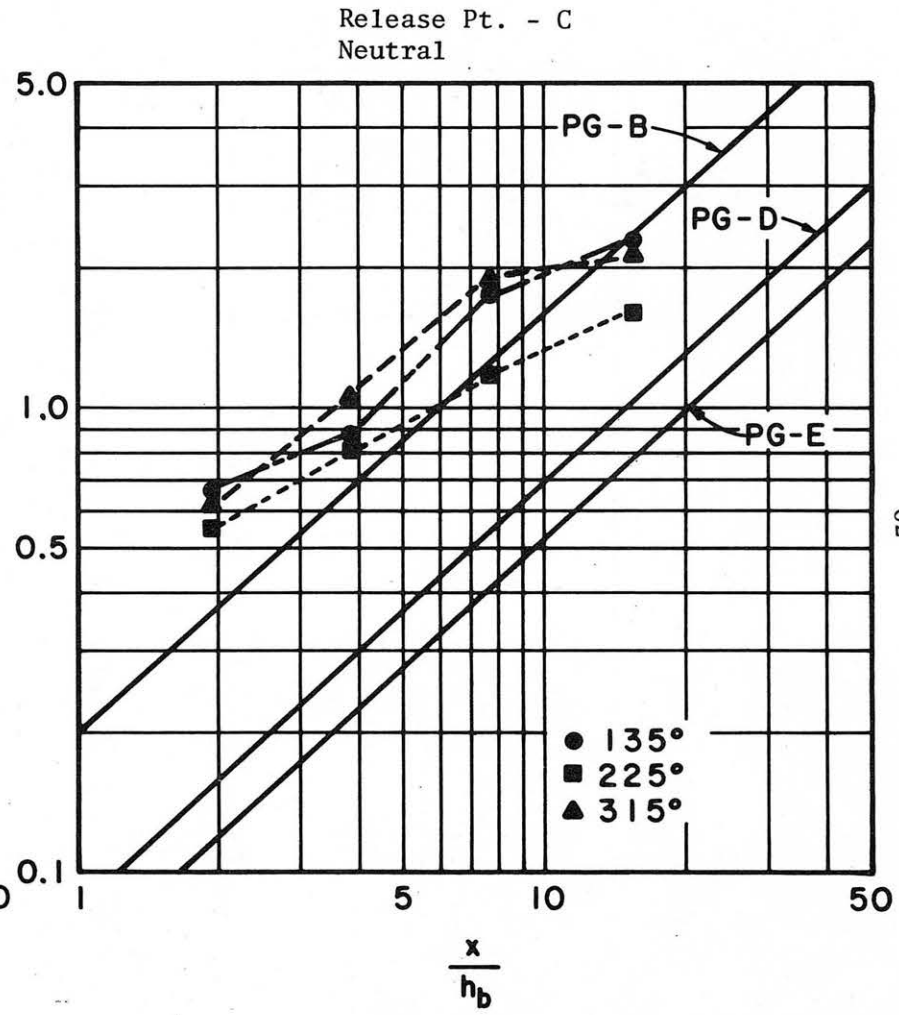
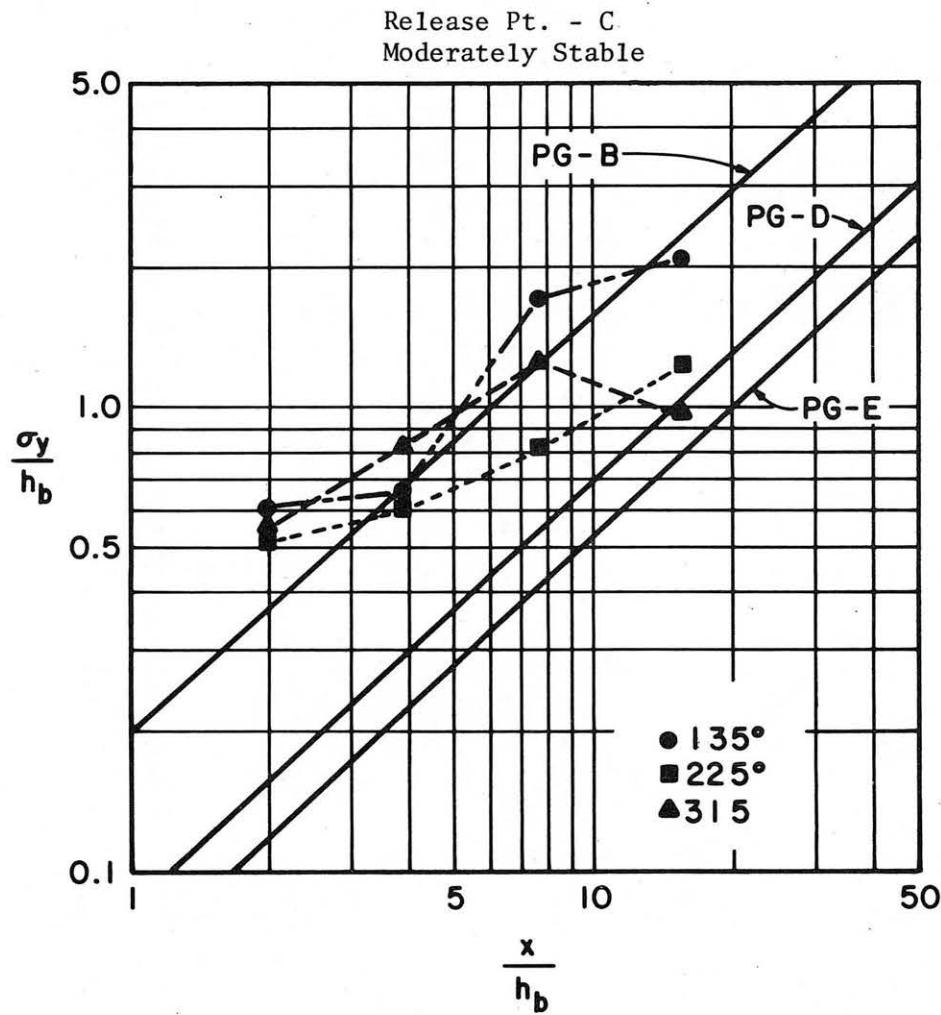

Figure 32. Plot of σ_y/h_b versus x/h_b for Release Point C

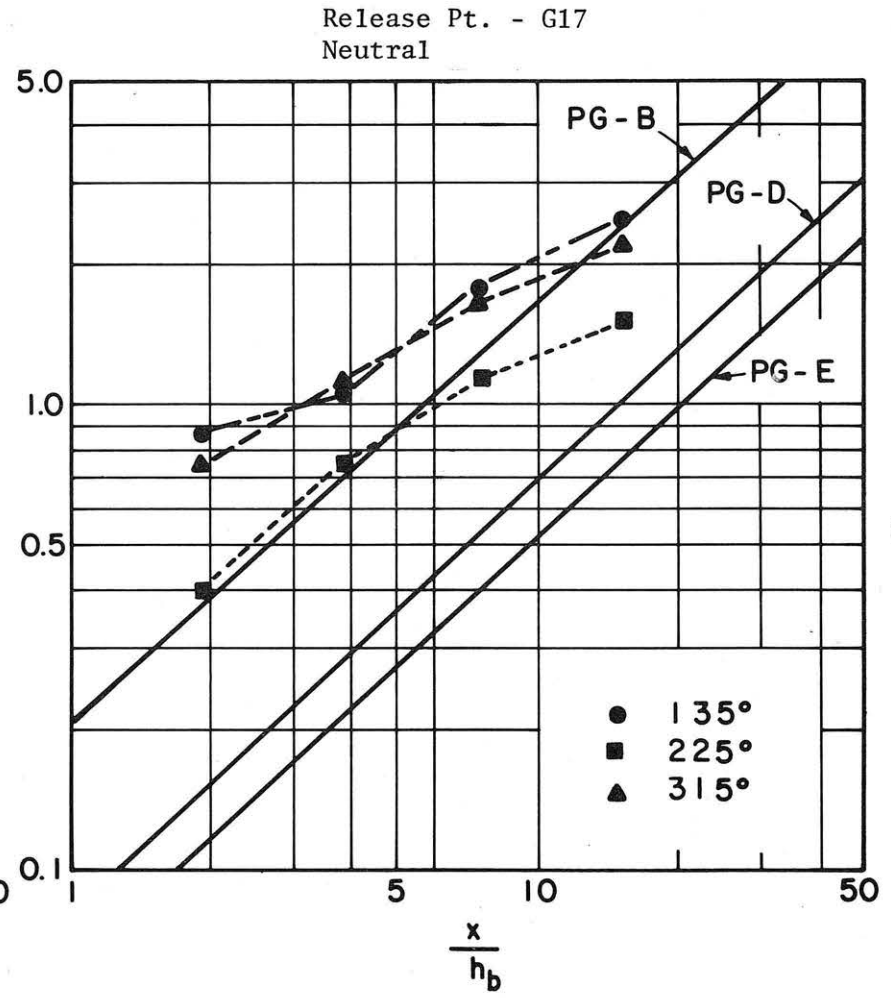
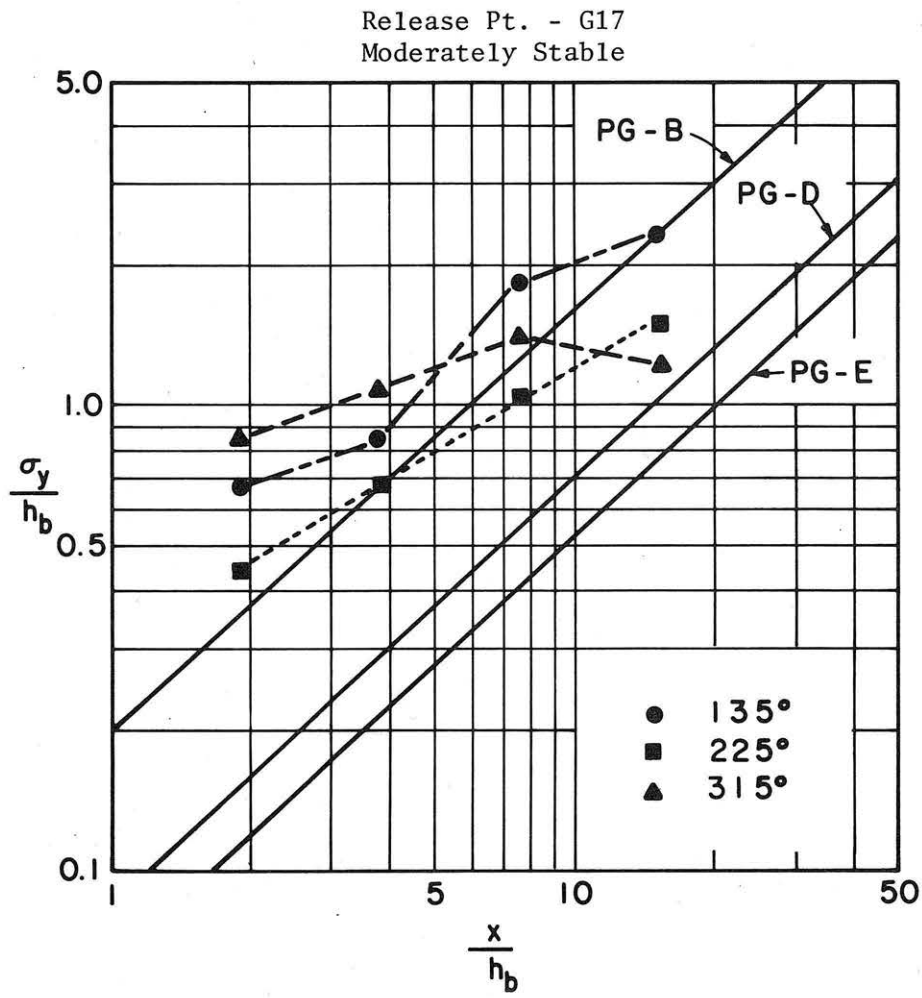
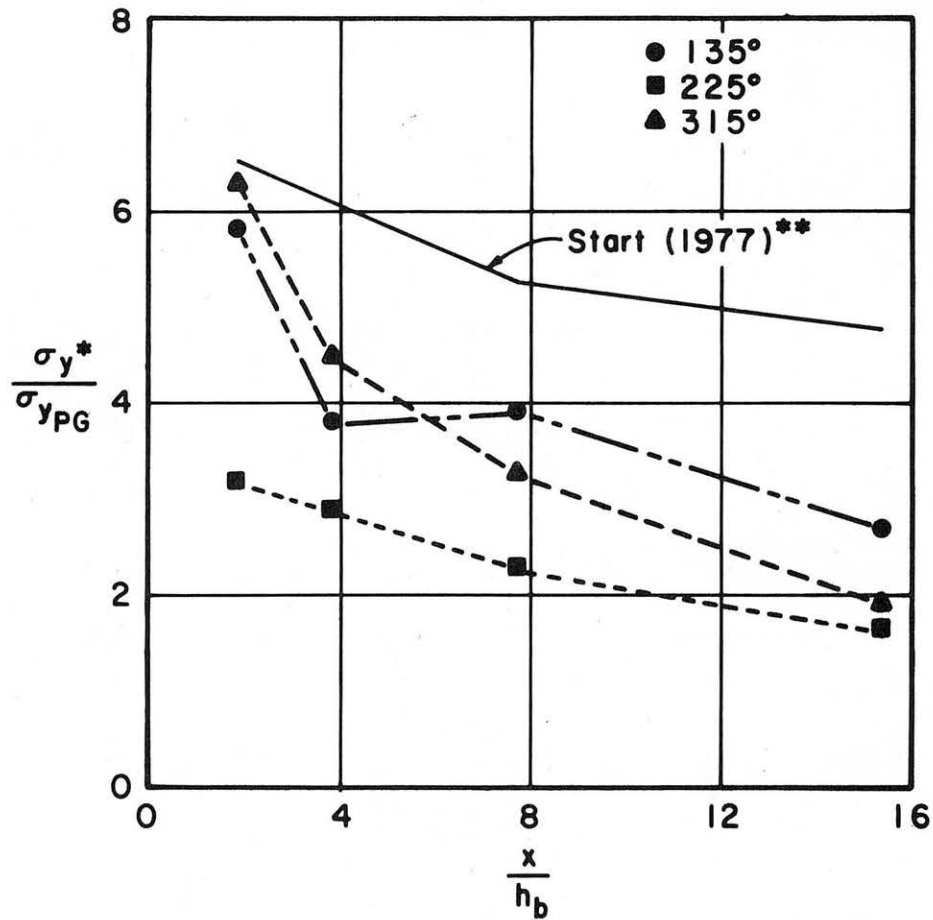

Figure 33. Plot of σ_y/h_b Versus x/h_b for Release Point G17



* Observations for each Wind Direction are Average of Moderately Stable and Neutral Cases.

** Observations are Average of All Field Data.

Figure 34. Plot of Ratio of σ_y Observed to σ_y From Pasquill-Gifford Curves Versus x/h_b for G17 Release.

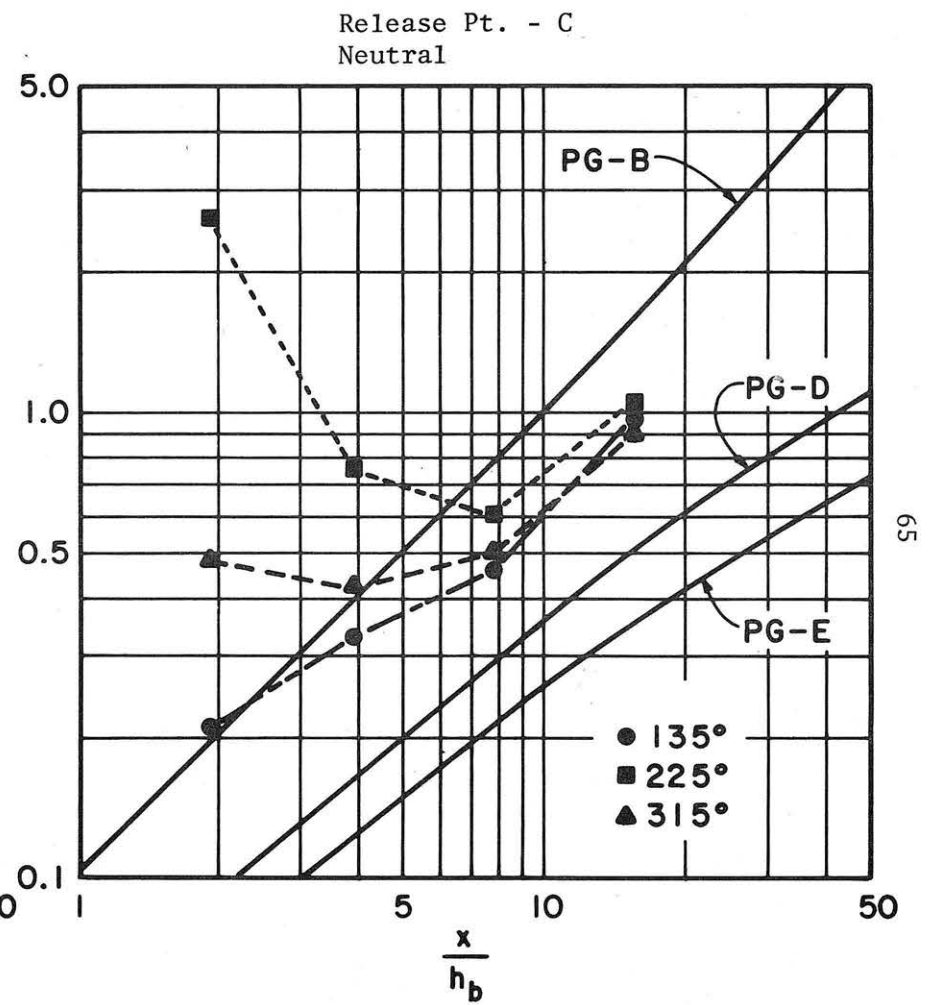
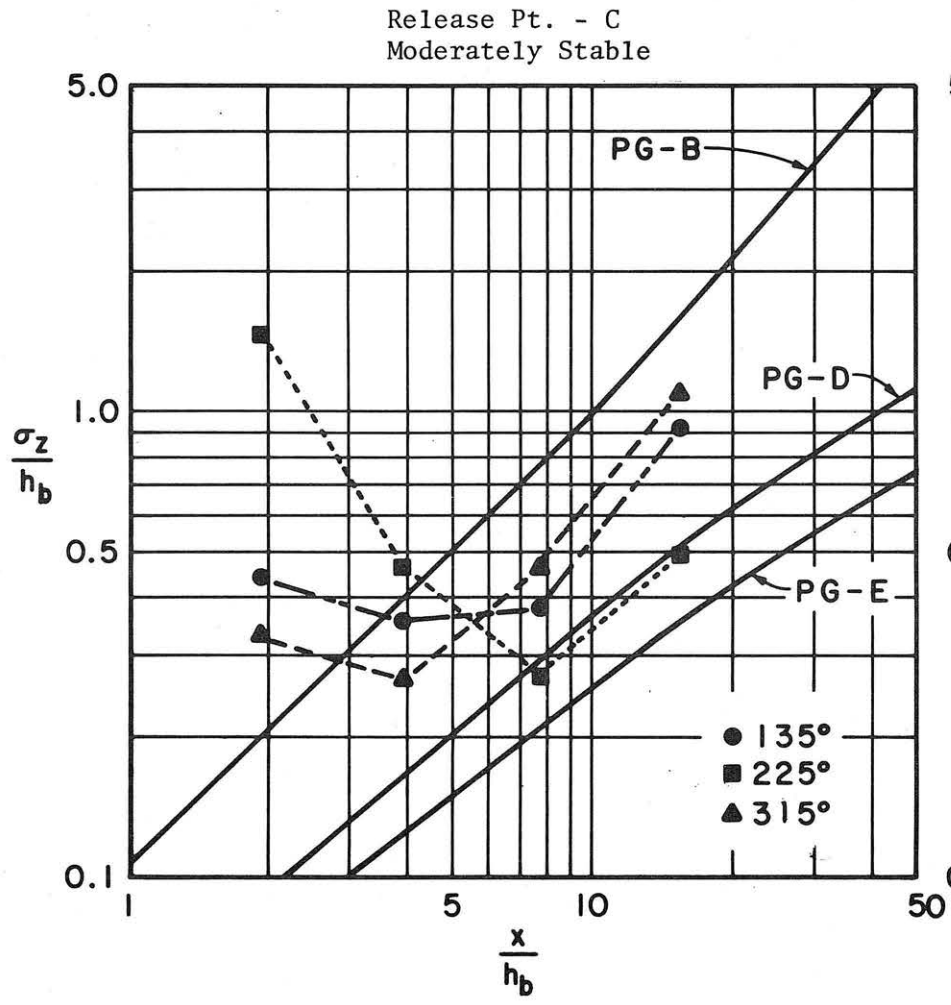
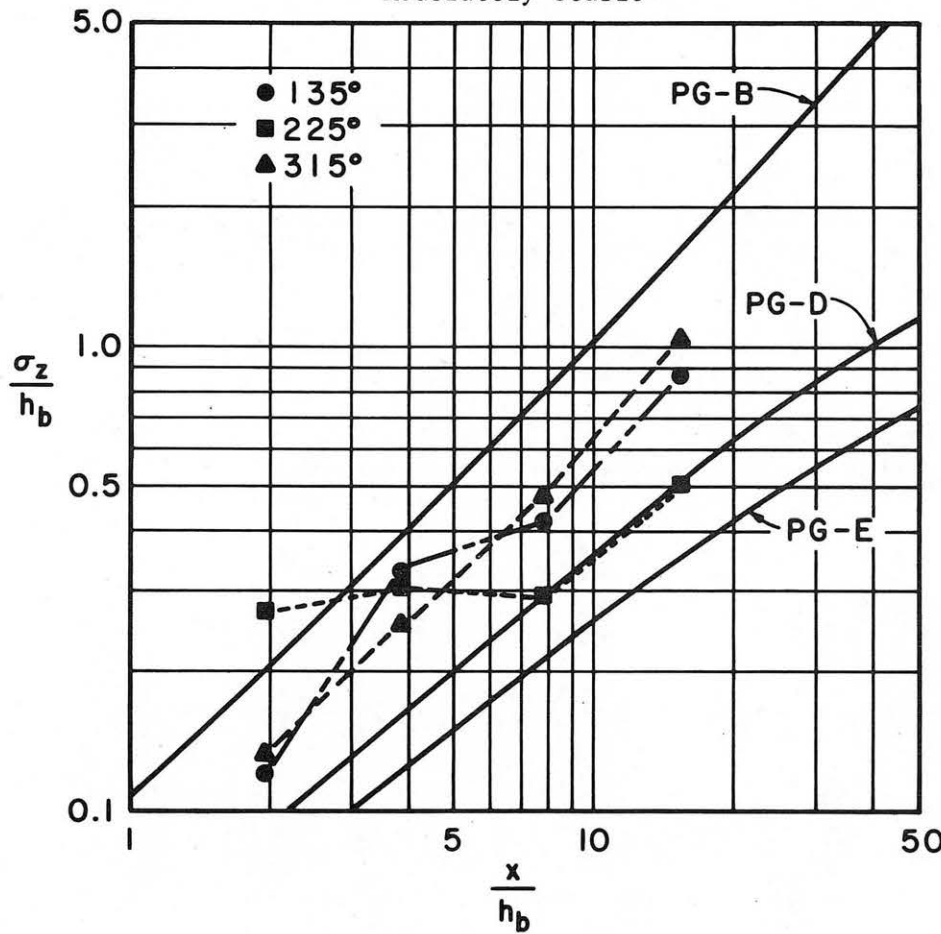

Figure 35. Plot of σ_z/h_b versus x/h_b for Release Point C.

Release Pt. - G17
Moderately Stable



Release Pt. - G17
Neutral

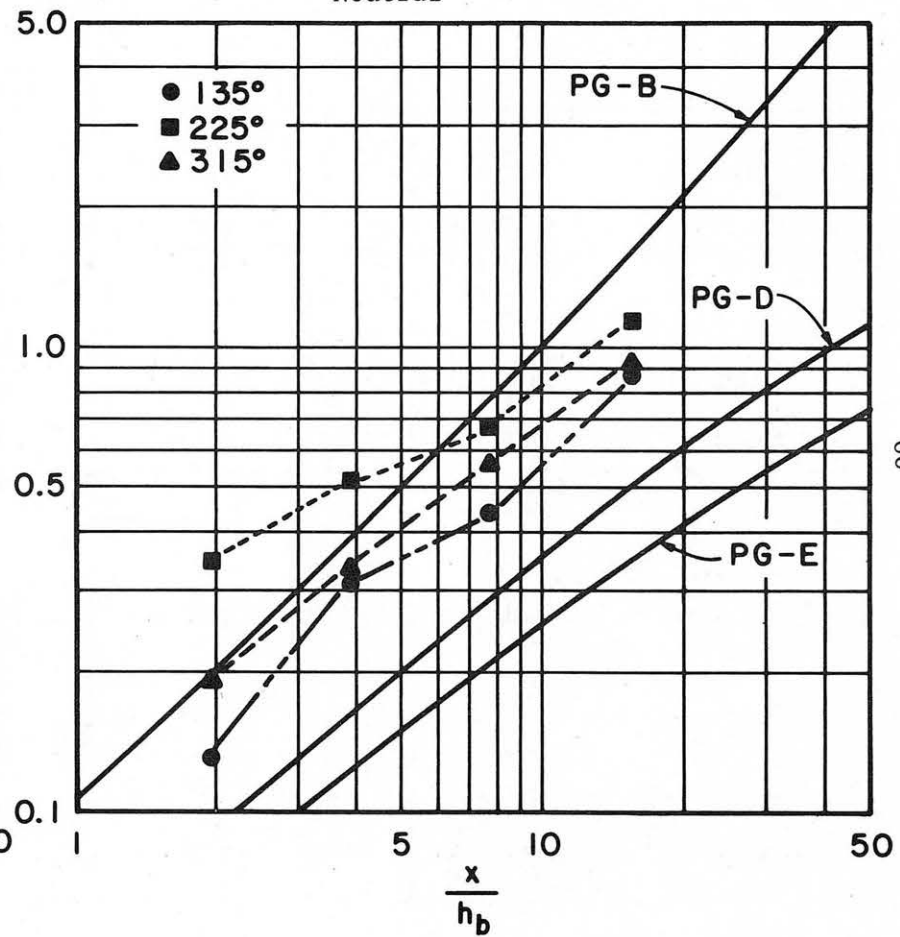
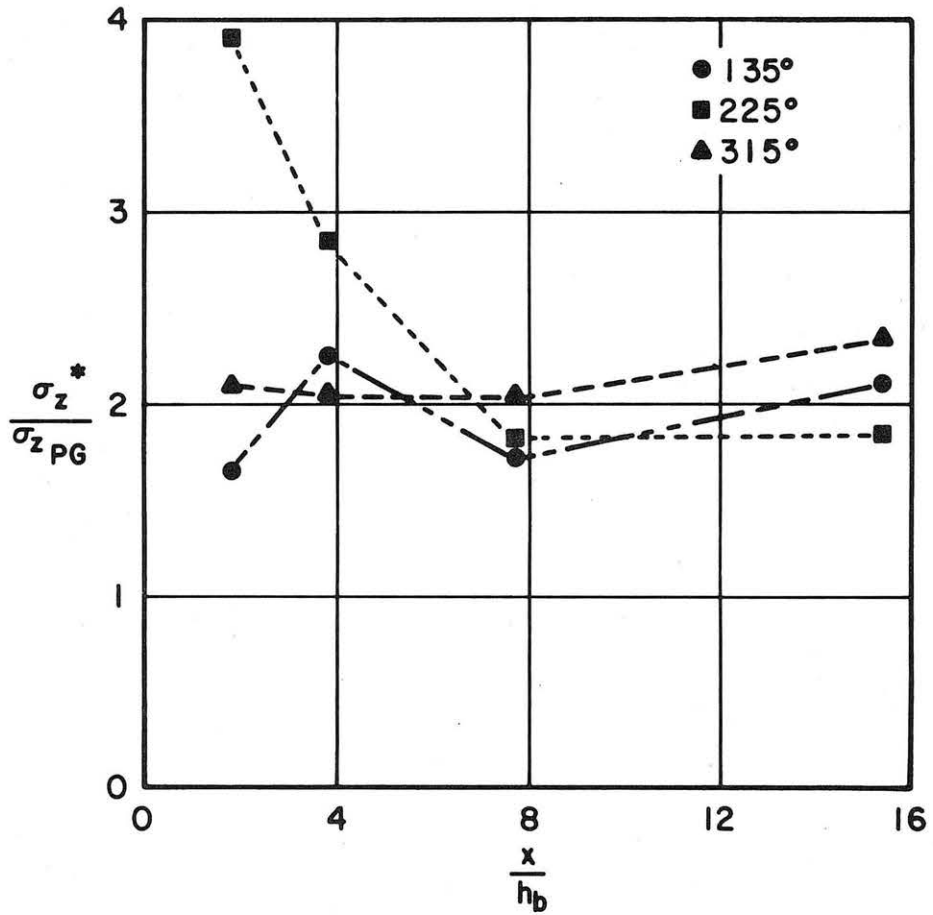

Figure 36. Plot of σ_z/h_b Versus x/h_b for Release Point G17.



*Observations for each Wind Direction are Average of Moderately Stable and Neutral Cases.

Figure 37. Plot of Ratio of σ_z Observed to σ_z from Pasquill-Gifford Curves Versus x/h_b for G17 Release

Table 1. Comparison of Modeling Parameters for Model and Prototype

PARAMETER	MODEL				PROTOTYPE			
Cont. Vessel height (h_b)	0.104m				52m			
Cooling Tower height	0.26m				130m			
Release Point height:								
Cont. Vessel Top (C)	0.104m				52m			
Aux. Building Top (A)	0.037m				18.4m			
Gnd. Cont. Vessel (G5)	0.0m				0.0m			
Gnd. Cont. Vessel (G17)	0.0m				0.0m			
Release Port diameters	0.0032m				--			
Met. Tower height (Z_r)	0.092m				46m			
Reference Velocity (U_r)	1.45m/sec				4.9m/sec			
Z_o/Z_r	2.96×10^{-4}				3.02×10^{-4}			
U_* / U_r	0.049				0.045			
Atmospheric Stability	PG*	Ri_b	Z_r/L	p^{**}	PG*	Ri_b	Z_r/L	p^{**}
Slightly Unstable	C-D	-0.32	-0.67	0.10	C-D	-0.62	-1.18	0.10
Neutral	D	0.0	0.0	0.15	D	0.0	0.0	0.16
Moderately Stable	E-F	0.35	1.44	0.44	F	0.57	2.30	0.35

*Pasquill-Gifford stability category.

**Power law exponent.

Table 2. Modeling Parameters Calculated from Rancho Seco Field Data

FIELD TEST NUMBER	*p	*r ²	*Ri _b	*P-G Stability	*NRC Assigned Stability
1	0.002	0.01	-13.08	A	A
2	--	--	--	-	G
3	0.138	1.00	7.41	G	G
4	0.147	0.40	23.73	G	G
5	-.143	0.19	126.06	G	G
6	0.077	1.00	-0.65	A-B	D
7	0.102	1.00	-1.35	A	A
8	--	--	--	-	G
9	0.110	0.98	-6.37	A	D
10	--	--	--	-	F
11	0.201	0.99	--	-	E
12	0.374	0.94	0	D	E
13	0.037	0.16	44.77	G	F
14	0.590	0.99	0.64	F	G
15	0.191	0.96	-0.66	A-B	D
16	0.148	0.98	17.70	G	E
17	0.173	0.81	8.23	G	G
18	-.012	0.01	∞	G	F
19	0.224	1.00	1.92	G	E
20	--	--	--	-	G
21	0.243	0.99	1.99	G	G
22	0.120	0.96	--	-	D
23	--	--	0.40	F	F

*p is the power law exponent.

r² is the coef. of determination for the power law curve fit.

Ri_b is the bulk Richardson number.

L is the Monin-Obukhov length

P-G is the Pasquill-Gifford stability category.

NRC is the stability assigned by the lapse rate criteria.

Table 3. Neutral Boundary Layer Modeling Parameters Calculated From Rancho Seco Field Data

FIELD TEST NUMBER	Z_r (m)	U_r (m/s)	$\frac{U_*}{U_r}$	$\frac{Z_o}{Z_r}$	
7	46	5.9	0.034	0.10×10^{-4}	
11	46	6.4	0.050	6.38×10^{-4}	
22	46	2.8	0.052	2.57×10^{-4}	
			0.045	3.02×10^{-4}	Average

U_* is the friction velocity.
 Z_o is the surface roughness.

Table 4. Maximum Ground-Level Nondimensional Concentration Coefficient for all Wind Tunnel Runs

DISTANCE DOWNWIND	STABILITY CLASS	RELEASE POINT	WIND DIRECTION							
			000	045	090	135	180	225	270	315
100m	NEUTRAL	C	1.95	3.91	3.58	2.29	.06	.37	1.16	1.20
		A	2.09	1.68	2.11	1.15	1.87	2.78	2.05	1.83
		G5	1.37	2.24	2.39	2.60	2.79	2.47	2.94	1.58
		G17	1.77	2.39	2.58	2.31	2.36	2.06	2.58	2.49
	MOD. STABLE	C	1.90	6.45	6.60	1.30	.10	.75	1.16	2.33
		A	1.69	3.07	3.04	2.58	3.32	3.28	3.12	2.62
		G5	3.11	3.59	2.96	3.56	3.23	3.11	2.81	2.37
		G17	1.73	4.08	4.50	3.56	2.88	3.88	4.32	2.71
	SLT. UNSTABLE	C	1.16	4.47	3.82	2.49	.08	.63	1.54	1.23
		A	1.40	2.32	2.51	1.16	2.18	4.75	3.00	1.86
		G5	1.61	3.17	2.74	2.23	5.06	4.26	3.18	1.76
		G17	1.42	3.09	2.30	2.12	1.55	2.08	2.54	1.17
200m	NEUTRAL	C	1.32	1.90	2.00	1.33	.58	.73	1.17	.94
		A	1.23	1.02	.99	.85	.79	1.52	1.54	.92
		G5	.71	1.21	1.05	.86	.91	1.11	1.13	.78
		G17	.98	1.34	1.58	1.08	.67	1.02	1.73	1.02
	MOD. STABLE	C	1.77	3.47	3.66	1.37	1.39	1.40	1.42	1.63
		A	1.73	2.19	2.26	1.81	2.62	2.14	2.24	1.18
		G5	2.23	2.25	1.89	1.72	2.44	2.31	1.76	1.45
		G17	1.62	2.68	3.27	1.36	.87	1.91	1.94	1.25
	SLT. UNSTABLE	C	1.21	1.72	1.82	1.34	.58	.94	1.05	.74
		A	.89	1.22	1.04	.84	.75	1.46	1.24	.76
		G5	.73	1.74	1.18	.86	1.55	1.54	1.55	.75
		G17	1.03	1.52	1.25	.97	.52	.97	1.33	.59
400m	NEUTRAL	C	.62	.51	.91	.51	.51	.62	.66	.47
		A	.62	.35	.49	.44	.57	.79	.69	.53
		G5	.51	.42	.42	.35	.63	.62	.58	.40
		G17	.47	.56	.89	.51	.48	.52	.99	.56
	MOD. STABLE	C	1.27	1.36	1.71	.75	1.25	1.47	.94	.93
		A	1.12	1.08	1.34	.69	.95	1.30	1.22	1.09
		G5	1.32	1.04	.62	.78	1.01	1.71	1.04	.85
		G17	1.02	1.29	1.26	.58	.89	1.14	.89	.68
	SLT. UNSTABLE	C	.54	.60	.84	.45	.46	.45	.38	.30
		A	.42	.50	.60	.37	.31	.58	.46	.35
		G5	.53	.77	.82	.34	.44	.61	.62	.37
		G17	.50	.64	.75	.38	.31	.49	.43	.22
800m	NEUTRAL	C	.23	.25	.41	.19	.27	.34	.34	.21
		A	.24	.23	.34	.17	.23	.38	.34	.24
		G5	.20	.24	.29	.16	.20	.29	.28	.19
		G17	.20	.28	.43	.20	.26	.29	.50	.22
	MOD. STABLE	C	.30	.74	.80	.21	.75	.81	.55	.39
		A	.37	.79	.84	.24	.76	.70	.53	.25
		G5	.57	.69	.50	.35	.83	.89	.56	.32
		G17	.24	.72	.71	.20	.67	.64	.40	.39
	SLT. UNSTABLE	C	.22	.23	.28	.16	.17	.14	.13	.13
		A	.18	.21	.25	.12	.17	.21	.18	.13
		G5	.26	.31	.38	.12	.20	.24	.26	.15
		G17	.23	.27	.29	.14	.17	.21	.17	.11

Table 5. Calculated Horizontal and Vertical Dispersion Coefficients From Wind Tunnel Data

STABILITY CLASS	WIND DIRECTION	DISTANCE DOWNWIND	SIGMA-Y (m)		SIGMA-Z (m)	
			REL. PT. C	REL. PT. G17	REL. PT. C	REL. PT. G17
NEUTRAL	135	100	35	46	11	7
		200	45	56	17	16
		400	89	93	24	23
		800	120	131	51	45
	225	100	29	21	136	18
		200	43	39	39	27
		400	60	59	31	34
		800	83	78	51	58
	315	100	32	39	25	10
		200	54	59	22	17
		400	97	91	26	29
		800	111	119	50	47
MOD. STABLE	135	100	31	36	23	6
		200	35	44	18	17
		400	89	97	20	22
		800	108	123	48	46
	225	100	27	22	77	14
		200	32	36	24	16
		400	42	54	14	15
		800	64	78	26	27
	315	100	29	46	17	7
		200	42	57	14	13
		400	66	73	24	25
		800	51	63	57	53

Table 6. Data, Wind Direction 0°

CONCENTRATION DATA FOR RUN NO. 1
 STABILITY: NEUTRAL
 WIND DIRECTION: 0 DEG.
 RELEASE POINT: C

SAMPLER GRID POINT	PROTOTYPE		MODEL		CONCENTRATION COEFFICIENT
	ARC (M)	ELEV (M)	DEGREES OFF* CENTER LINE		
100	100	0	60		.0001
97	100	0	42		.0001
94	100	0	24		.0481
91	100	0	6		.2333
89	100	0	-6		1.9490
86	100	0	-24		.5635
83	100	0	-42		.1183
80	100	0	-60		.0028
143	200	0	-42		.0058
145	200	0	-30		.0093
147	200	0	-18		.5464
150	200	0	0		1.3152
150	200	25	0		1.2237
150	200	76	0		.1750
151	200	0	6		1.1113
153	200	0	18		.1852
155	200	0	30		.0415
157	200	0	42		.0011
159	200	0	54		.0000
217	400	0	42		.0091
215	400	0	30		.0098
213	400	0	18		.0161
211	400	0	6		.4706
210	400	0	0		.6190
210	400	25	0		.4890
210	400	76	0		.1468
209	400	0	-6		.6353
207	400	0	-18		.0000
205	400	0	-30		.0518
267	800	0	-18		.0335
268	800	0	-12		.1285
270	800	0	0		.2269
270	800	25	0		.1822
270	800	76	0		.1148
270	800	127	0		.0521
271	800	0	6		.1035
272	800	0	12		.0622
273	800	0	18		.0168
274	800	0	24		.0001

* POSITIVE ANGLES ARE CLOCKWISE DIRECTION.

** MODEL SAMPLE LOCATION HALFWAY TO NEXT HIGHEST GRID POINT.

CONCENTRATION DATA FOR RUN NO. 10
 STABILITY: MODERATELY STABLE
 WIND DIRECTION: 0 DEG.
 RELEASE POINT: C

SAMPLER GRID POINT	PROTOTYPE		MODEL		CONCENTRATION COEFFICIENT
	ARC (M)	ELEV (M)	DEGREES OFF* CENTER LINE		
100	100	0	60		.0000
97	100	0	42		.0000
94	100	0	24		.2035
91	100	0	6		1.3025
89	100	0	-6		1.8952
86	100	0	-24		.2901
83	100	0	-42		.0330
80	100	0	-60		.0000
143	200	0	-42		.0000
145	200	0	-30		.0000
147	200	0	-18		.1983
150	200	0	0		1.5752
150	200	25	0		.6992
150	200	76	0		1.4152
151	200	0	6		1.7667
153	200	0	18		.6809
155	200	0	30		.0278
157	200	0	42		.0000
159	200	0	54		.0000
217	400	0	42		.0000
215	400	0	30		.0000
213	400	0	18		.0068
211	400	0	6		1.2710
210	400	0	0		.6992
210	400	25	0		.6678
210	400	76	0		.2770
209	400	0	-6		.1799
207	400	0	-18		.0000
205	400	0	-30		.0000
267	800	0	-18		.0000
268	800	0	-12		.0016
270	800	0	0		.3032
270	800	25	0		.3425
270	800	76	0		.1117
270	800	127	0		.0121
271	800	0	6		.0462
272	800	0	12		.0016
273	800	0	18		.0000
274	800	0	24		.0000

* POSITIVE ANGLES ARE CLOCKWISE DIRECTION.

** MODEL SAMPLE LOCATION HALFWAY TO NEXT HIGHEST GRID POINT.

CONCENTRATION DATA FOR RUN NO. 17
 STABILITY: SLIGHTLY UNSTABLE
 WIND DIRECTION: 0 DEG.
 RELEASE POINT: C

SAMPLER GRID POINT	PROTOTYPE		MODEL		CONCENTRATION COEFFICIENT
	ARC (M)	ELEV (M)	DEGREES OFF* CENTER LINE		
100	100	0	60		.0348
97	100	0	42		.0348
94	100	0	24		.0929
91	100	0	6		.0000
89	100	0	-6		1.1606
86	100	0	-24		.4004
83	100	0	-42		.0638
80	100	0	-60		.0348
143	200	0	-42		.0406
145	200	0	-30		.0000
147	200	0	-18		.4178
150	200	0	0		.5107
150	200	25	0		1.2071
150	200	76	0		.9749
151	200	0	6		1.1200
153	200	0	18		.3250
155	200	0	30		.0696
157	200	0	42		.0406
159	200	0	54		.0406
217	400	0	42		.0406
215	400	0	30		.0348
213	400	0	18		.1219
211	400	0	6		.5397
210	400	0	0		.4933
210	400	25	0		.4410
210	400	76	0		.2089
209	400	0	-6		.4526
207	400	0	-18		.3656
205	400	0	-30		.0406
267	800	0	-18		.0522
268	800	0	-12		.0754
269	800	0	-6		.1973
270	800	0	0		.2205
270	800	25	0		.1857
270	800	76	0		.1161
270	800	127	0		.0987
271	800	0	6		.1915
272	800	0	12		.1161
273	800	0	18		.0522
274	800	0	24		.0754

* POSITIVE ANGLES ARE CLOCKWISE DIRECTION.

** MODEL SAMPLE LOCATION HALFWAY TO NEXT HIGHEST GRID POINT.

CONCENTRATION DATA FOR RUN NO. 1

STABILITY: NEUTRAL

WIND DIRECTION: 0 DEG.

RELEASE POINT: A

SAMPLER GRID POINT	PROTOTYPE		MODEL		CONCENTRATION COEFFICIENT
	ARC (M)	ELEV (M)	DEGREES OFF* CENTER LINE		
100	100	0	60		.0150
97	100	0	42		.0261
94	100	0	24		.2108
91	100	0	6		.2541
89	100	0	-6		2.0921
86	100	0	-24		.9666
83	100	0	-42		.1815
80	100	0	-60		.0044
143	200	0	-42		.0014
145	200	0	-30		.0205
147	200	0	-18		.6046
150	200	0	0		1.2273
150	200	25	0		1.0440
150	200	76	0		.1530
151	200	0	6		.9724
153	200	0	18		.2254
155	200	0	30		.0319
157	200	0	42		.0080
159	200	0	54		.0000
217	400	0	42		.0080
215	400	0	30		.0100
213	400	0	18		.0100
211	400	0	6		.4588
210	400	0	0		.5924
210	400	25	0		.4368
210	400	76	0		.1316
209	400	0	-6		.6183
207	400	0	-18		.4927
205	400	0	-30		.0279
267	800	0	-18		.0239
268	800	0	-12		.1177
270	800	0	0		.2473
270	800	25	0		.1636
270	800	76	0		.1037
270	800	127	0		.0419
271	800	0	6		.1117
272	800	0	12		.0379
273	800	0	18		.0140
274	800	0	24		.0040

* POSITIVE ANGLES ARE CLOCKWISE DIRECTION.

** MODEL SAMPLE LOCATION HALFWAY TO NEXT HIGHEST GRID POINT.

CONCENTRATION DATA FOR RUN NO. 10

STABILITY: MODERATELY STABLE

WIND DIRECTION: 0 DEG.

RELEASE POINT: A

SAMPLER GRID POINT	PROTOTYPE		MODEL		CONCENTRATION COEFFICIENT
	ARC (M)	ELEV (M)	DEGREES OFF* CENTER LINE		
100	100	0	60		.0117
97	100	0	42		.0750
94	100	0	24		.8155
91	100	0	6		1.6880
89	100	0	-6		.2164
86	100	0	-24		1.5146
83	100	0	-42		.2183
80	100	0	-60		.0081
143	200	0	-42		.0048
145	200	0	-30		.0084
147	200	0	-18		.4019
150	200	0	0		1.7257
150	200	25	0		.8838
150	200	76	0		1.5395
151	200	0	6		1.4994
153	200	0	18		.8752
155	200	0	30		.1698
157	200	0	42		.0146
159	200	0	54		.0081
217	400	0	42		.0048
215	400	0	30		.0074
213	400	0	18		.0454
211	400	0	6		1.1214
210	400	0	0		.7980
210	400	25	0		.6469
210	400	76	0		.3085
209	400	0	-6		.3436
207	400	0	-18		.0167
205	400	0	-30		.0029
267	800	0	-18		.0046
268	800	0	-12		.0139
270	800	0	0		.3563
270	800	25	0		.3501
270	800	76	0		.1170
270	800	127	0		.0144
271	800	0	6		.0454
272	800	0	12		.0077
273	800	0	18		.0060
274	800	0	24		.0000

* POSITIVE ANGLES ARE CLOCKWISE DIRECTION.

** MODEL SAMPLE LOCATION HALFWAY TO NEXT HIGHEST GRID POINT.

CONCENTRATION DATA FOR RUN NO. 17
 STABILITY: SLIGHTLY UNSTABLE
 WIND DIRECTION: 0 DEG.
 RELEASE POINT: A

SAMPLER GRID POINT	PROTOTYPE		MODEL		CONCENTRATION COEFFICIENT
	ARC (M)	ELEV (M)	DEGREES OFF* CENTER LINE		
100	100	0	60		.0153
97	100	0	42		.0171
94	100	0	24		.1888
91	100	0	6		.1074
89	100	0	-6		1.4009
86	100	0	-24		.6225
83	100	0	-42		.0212
80	100	0	-60		.0106
143	200	0	-42		.0089
145	200	0	-30		.0266
147	200	0	-18		.3877
150	200	0	0		.4013
150	200	25	0		.9258
150	200	76	0		.7954
151	200	0	6		.8786
153	200	0	18		.3570
155	200	0	30		.0679
157	200	0	42		.0248
159	200	0	54		.0165
217	400	0	42		.0000
215	400	0	30		.0106
213	400	0	18		.1080
211	400	0	6		.4243
210	400	0	0		.4131
210	400	25	0		.3358
210	400	76	0		.1806
209	400	0	-6		.3747
207	400	0	-18		.2962
205	400	0	-30		.0207
267	800	0	-18		.0000
268	800	0	-12		.0484
269	800	0	-6		.1564
270	800	0	0		.1758
270	800	25	0		.1428
270	800	76	0		.0797
270	800	127	0		.0596
271	800	0	6		.1334
272	800	0	12		.0791
273	800	0	18		.0248
274	800	0	24		.0000

* POSITIVE ANGLES ARE CLOCKWISE DIRECTION.

** MODEL SAMPLE LOCATION HALFWAY TO NEXT HIGHEST GRID POINT.

CONCENTRATION DATA FOR RUN NO. 1
 STABILITY: NEUTRAL
 WIND DIRECTION: 0 DEG.
 RELEASE POINT: G5

SAMPLER GRID POINT	PROTOTYPE		MODEL		CONCENTRATION COEFFICIENT
	ARC (M)	ELEV (M)	DEGREES OFF* CENTER LINE		
100	100	0	60		.0032
97	100	0	42		.0050
94	100	0	24		.0287
91	100	0	6		.0789
89	100	0	-6		.9405
86	100	0	-24		1.3692
83	100	0	-42		.2742
80	100	0	-60		.0010
143	200	0	-42		.0000
145	200	0	-30		.0141
147	200	0	-18		.5964
150	200	0	0		.7119
150	200	25	0		.9400
150	200	76	0		.1726
151	200	0	6		.3913
153	200	0	18		.0765
155	200	0	30		.0100
157	200	0	42		.0013
159	200	0	54		.0000
217	400	0	42		.0002
215	400	0	30		.0013
213	400	0	18		.0013
211	400	0	6		.2639
210	400	0	0		.4459
210	400	25	0		.3838
210	400	76	0		.1255
209	400	0	-6		.5048
207	400	0	-18		.4078
205	400	0	-30		.0187
267	800	0	-18		.0166
268	800	0	-12		.1070
270	800	0	0		.1964
270	800	25	0		.1397
270	800	76	0		.0939
270	800	127	0		.0340
271	800	0	6		.0776
272	800	0	12		.0253
273	800	0	18		.0078
274	800	0	24		.0000

* POSITIVE ANGLES ARE CLOCKWISE DIRECTION.

** MODEL SAMPLE LOCATION HALFWAY TO NEXT HIGHEST GRID POINT.

CONCENTRATION DATA FOR RUN NO. 10
 STABILITY: MODERATELY STABLE
 WIND DIRECTION: 0 DEG.
 RELEASE POINT: G5

SAMPLER GRID POINT	PROTOTYPE		MODEL		CONCENTRATION COEFFICIENT
	ARC (M)	ELEV (M)	DEGREES OFF* CENTER LINE		
100	100	0	60		.0015
97	100	0	42		.0106
94	100	0	24		.0666
91	100	0	6		1.0946
89	100	0	-6		2.7306
86	100	0	-24		3.1103
83	100	0	-42		1.7416
80	100	0	-60		.0597
143	200	0	-42		.0047
145	200	0	-30		.0152
147	200	0	-18		1.7397
150	200	0	0		2.2313
150	200	25	0		.7557
150	200	76	0		1.7186
151	200	0	6		.9121
153	200	0	18		.2018
155	200	0	30		.0152
157	200	0	42		.0024
159	200	0	54		.0010
217	400	0	42		.0000
215	400	0	30		.0000
213	400	0	18		.0079
211	400	0	6		1.0212
210	400	0	0		1.3206
210	400	25	0		.7787
210	400	76	0		.2940
209	400	0	-6		.7177
207	400	0	-18		.0432
205	400	0	-30		.0010
267	800	0	-18		.0001
268	800	0	-12		.0258
270	800	0	0		.5737
270	800	25	0		.4247
270	800	76	0		.0978
270	800	127	0		.0042
271	800	0	6		.0322
272	800	0	12		.0015
273	800	0	18		.0000
274	800	0	24		.0000

* POSITIVE ANGLES ARE CLOCKWISE DIRECTION.

** MODEL SAMPLE LOCATION HALFWAY TO NEXT HIGHEST GRID POINT.

CONCENTRATION DATA FOR RUN NO. 17
 STABILITY: SLIGHTLY UNSTABLE
 WIND DIRECTION: 0 DEG.
 RELEASE POINT: G5

SAMPLER GRID POINT	PROTOTYPE		MODEL		CONCENTRATION COEFFICIENT
	ARC (M)	ELEV (M)	DEGREES OFF* CENTER LINE		
100	100	0	60		.0113
97	100	0	42		.0088
94	100	0	24		.0428
91	100	0	6		.0516
89	100	0	-6		1.6117
86	100	0	-24		1.3360
83	100	0	-42		.0290
80	100	0	-60		.0139
143	200	0	-42		.0088
145	200	0	-30		.0214
147	200	0	-18		.5452
150	200	0	0		.7253
150	200	25	0		.8789
150	200	76	0		1.3045
151	200	0	6		.6611
153	200	0	18		.1763
155	200	0	30		.0315
157	200	0	42		.0164
159	200	0	54		.0113
217	400	0	42		.0139
215	400	0	30		.0088
213	400	0	18		.0781
211	400	0	6		.4923
210	400	0	0		.4948
210	400	25	0		.5591
210	400	76	0		.2921
209	400	0	-6		.5288
207	400	0	-18		.3979
205	400	0	-30		.0227
267	800	0	-18		.0201
268	800	0	-12		.0642
269	800	0	-6		.2153
270	800	0	0		.2556
270	800	25	0		.2027
270	800	76	0		.1549
270	800	127	0		.0957
271	800	0	6		.1599
272	800	0	12		.0995
273	800	0	18		.0290
274	800	0	24		.0189

* POSITIVE ANGLES ARE CLOCKWISE DIRECTION.

** MODEL SAMPLE LOCATION HALFWAY TO NEXT HIGHEST GRID POINT.

CONCENTRATION DATA FOR RUN NO. 1

STABILITY: NEUTRAL

WIND DIRECTION: 0 DEG.

RELEASE POINT: G17

SAMPLER GRID POINT	PROTOTYPE		MODEL		CONCENTRATION COEFFICIENT
	ARC (M)	ELEV (M)	DEGREES OFF* CENTER LINE		
100	100	0	60		.0507
97	100	0	42		.0682
94	100	0	24		.2716
91	100	0	6		.2283
89	100	0	-6		1.7731
86	100	0	-24		.6109
83	100	0	-42		.1128
80	100	0	-60		.0012
143	200	0	-42		.0014
145	200	0	-30		.0086
147	200	0	-18		.4622
150	200	0	0		.9824
150	200	25	0		.7933
150	200	76	0		.1135
151	200	0	6		.8821
153	200	0	18		.2517
155	200	0	30		.0572
157	200	0	42		.0127
159	200	0	54		.0000
217	400	0	42		.0023
215	400	0	30		.0040
213	400	0	18		.0111
211	400	0	6		.3907
210	400	0	0		.4770
210	400	25	0		.3473
210	400	76	0		.1018
209	400	0	-6		.4721
207	400	0	-18		.3880
205	400	0	-30		.0204
267	800	0	-18		.0144
268	800	0	-12		.0891
270	800	0	0		.1963
270	800	25	0		.1331
270	800	76	0		.0798
270	800	127	0		.0309
271	800	0	6		.0869
272	800	0	12		.0375
273	800	0	18		.0078
274	800	0	24		.0007

* POSITIVE ANGLES ARE CLOCKWISE DIRECTION.

** MODEL SAMPLE LOCATION HALFWAY TO NEXT HIGHEST GRID POINT.

CONCENTRATION DATA FOR RUN NO. 10
 STABILITY: MODERATELY STABLE
 WIND DIRECTION: 0 DEG.
 RELEASE POINT: G17

SAMPLER GRID POINT	PROTOTYPE		MODEL		CONCENTRATION COEFFICIENT
	ARC (M)	ELEV (M)	DEGREES OFF* CENTER LINE		
100	100	0	60		.0179
97	100	0	42		.0502
94	100	0	24		.7489
91	100	0	6		1.4553
89	100	0	-6		1.7321
86	100	0	-24		.3873
83	100	0	-42		.0513
80	100	0	-60		.0000
143	200	0	-42		.0011
145	200	0	-30		.0000
147	200	0	-18		.1551
150	200	0	0		1.2556
150	200	25	0		.5513
150	200	76	0		1.0870
151	200	0	6		1.6205
153	200	0	18		1.0491
155	200	0	30		.1596
157	200	0	42		.0033
159	200	0	54		.0000
217	400	0	42		.0000
215	400	0	30		.0000
213	400	0	18		.0357
211	400	0	6		1.0245
210	400	0	0		.5569
210	400	25	0		.5078
210	400	76	0		.2109
209	400	0	-6		.1685
207	400	0	-18		.0022
205	400	0	-30		.0000
267	800	0	-18		.0000
268	800	0	-12		.0045
270	800	0	0		.2388
270	800	25	0		.2723
270	800	76	0		.0993
270	800	127	0		.0123
271	800	0	6		.0413
272	800	0	12		.0078
273	800	0	18		.0000
274	800	0	24		.0000

* POSITIVE ANGLES ARE CLOCKWISE DIRECTION.

** MODEL SAMPLE LOCATION HALFWAY TO NEXT HIGHEST GRID POINT.

CONCENTRATION DATA FOR RUN NO. 17
 STABILITY: SLIGHTLY UNSTABLE
 WIND DIRECTION: 0 DEG.
 RELEASE POINT: G17

SAMPLER GRID POINT	PROTOTYPE ARC (M)	ELEV (M)	MODEL DEGREES OFF* CENTER LINE	CONCENTRATION COEFFICIENT
100	100	0	60	.0312
97	100	0	42	.0343
94	100	0	24	.1589
91	100	0	6	.0904
89	100	0	-6	1.4239
86	100	0	-24	.5452
83	100	0	-42	.0343
80	100	0	-60	.0280
143	200	0	-42	.0280
145	200	0	-30	.0343
147	200	0	-18	.4362
150	200	0	0	.4611
150	200	25	0	1.0469
150	200	76	0	.8412
151	200	0	6	1.0250
153	200	0	18	.4019
155	200	0	30	.0748
157	200	0	42	.0312
159	200	0	54	.0312
217	400	0	42	.0343
215	400	0	30	.0280
213	400	0	18	.1433
211	400	0	6	.4954
210	400	0	0	.4673
210	400	25	0	.3957
210	400	76	0	.2368
209	400	0	-6	.4237
207	400	0	-18	.3863
205	400	0	-30	.0499
267	800	0	-18	.0717
268	800	0	-12	.0779
269	800	0	-6	.2119
270	800	0	0	.2274
270	800	25	0	.1932
270	800	76	0	.1122
270	800	127	0	.1277
271	800	0	6	.1901
272	800	0	12	.1402
273	800	0	18	.0654
274	800	0	24	.0810

* POSITIVE ANGLES ARE CLOCKWISE DIRECTION.

** MODEL SAMPLE LOCATION HALFWAY TO NEXT HIGHEST GRID POINT.

Table 7. Data, Wind Direction 45°

CONCENTRATION DATA FOR RUN NO. 2

STABILITY: NEUTRAL

WIND DIRECTION: 45 DEG.

RELEASE POINT: C

SAMPLER GRID POINT	PROTOTYPE		MODEL		CONCENTRATION COEFFICIENT
	ARC (M)	ELEV (M)	DEGREES OFF* CENTER LINE		
107	100	0	57		.0058
104	100	0	39		.1770
101	100	0	21		1.2506
98	100	0	3		3.8187
95	100	0	-15		3.9076
92	100	0	-33		.9407
89	100	0	-51		.1757
86	100	0	-69		.0071
149	200	0	-51		.0084
151	200	0	-39		.0437
153	200	0	-27		.4778
155	200	0	-15		1.9005
157**	200	0	0		1.6586
157**	200	25	0		.5353
157**	200	51	0		.0711
159	200	0	9		1.0388
161	200	0	21		.1653
163	200	0	33		.0058
165	200	0	45		.0071
225	400	0	45		.0084
223	400	0	33		.0097
221	400	0	21		.0071
219	400	0	9		.1888
217**	400	0	0		.5079
217**	400	25	0		.2594
217**	400	51	0		.0960
216	400	0	-9		.3575
214	400	0	-21		.0214
212	400	0	-33		.0071
274	800	0	-21		.0123
275	800	0	-15		.0201
276	800	0	-9		.2437
277**	800	0	0		.2516
277**	800	25	0		.1509
277**	800	76	0		.0515
277**	800	127	0		.0175
279	800	0	9		.0162
280	800	0	15		.0097
281	800	0	21		.0228
282	800	0	27		.0123

* POSITIVE ANGLES ARE CLOCKWISE DIRECTION.

** MODEL SAMPLE LOCATION HALFWAY TO NEXT HIGHEST GRID POINT.

CONCENTRATION DATA FOR RUN NO. 11
 STABILITY: MODERATELY STABLE
 WIND DIRECTION: 45 DEG.
 RELEASE POINT: C

SAMPLER GRID POINT	PROTOTYPE		MODEL	
	ARC (M)	ELEV (M)	DEGREES OFF* CENTER LINE	CONCENTRATION COEFFICIENT
107	100	0	57	.0277
104	100	0	39	.2727
101	100	0	21	2.7974
98	100	0	3	6.4491
95	100	0	-15	5.5124
92	100	0	-33	.9817
89	100	0	-51	.1545
86	100	0	-69	.0248
149	200	0	-51	.0219
151	200	0	-39	.0161
153	200	0	-27	.4139
155	200	0	-15	1.7310
157**	200	0	0	3.4747
157**	200	51	0	.0738
159	200	0	9	1.7195
161	200	0	21	.3159
163	200	0	33	.0306
165	200	0	45	.0219
225	400	0	45	.0133
223	400	0	33	.0190
221	400	0	21	.0911
219	400	0	9	1.0854
217**	400	0	0	1.3592
217**	400	25	0	.8462
217**	400	51	0	.1602
216	400	0	-9	.8693
214	400	0	-21	.0536
212	400	0	-33	.0277
274	800	0	-21	.0190
275	800	0	-15	.0363
276	800	0	-9	.2179
277**	800	0	0	.7424
277**	800	25	0	.3274
277**	800	76	0	.0421
277**	800	127	0	.0277
279	800	0	9	.7453
280	800	0	15	.3505
281	800	0	21	.0507
282	800	0	27	.0161

* POSITIVE ANGLES ARE CLOCKWISE DIRECTION.

** MODEL SAMPLE LOCATION HALFWAY TO NEXT HIGHEST GRID POINT.

CONCENTRATION DATA FOR RUN NO. 18
 STABILITY: SLIGHTLY UNSTABLE
 WIND DIRECTION: 45 DEG.
 RELEASE POINT: C

SAMPLER GRID POINT	PROTOTYPE		MODEL		CONCENTRATION COEFFICIENT
	ARC (M)	ELEV (M)	DEGREES OFF* CENTER LINE		
107	100	0	57		.0000
104	100	0	39		.0000
101	100	0	21		2.1240
98	100	0	3		3.8707
95	100	0	-15		4.4743
92	100	0	-33		.8589
89	100	0	-51		.1451
86	100	0	-69		.0000
149	200	0	-51		.0000
151	200	0	-39		.0232
153	200	0	-27		.1973
155	200	0	-15		1.5262
157**	200	0	0		1.7177
157**	200	25	0		.4352
157**	200	51	0		.1219
159	200	0	9		1.0794
161	200	0	21		.3888
163	200	0	33		.0174
165	200	0	45		.0000
224	400	0	39		.0000
222	400	0	27		.0000
220	400	0	15		.0929
219	400	0	9		.2437
217**	400	0	0		.5977
217**	400	25	0		.3656
217**	400	51	0		.0987
216	400	0	-9		.4991
214	400	0	-21		.4178
212	400	0	-33		.0174
274	800	0	-21		.0000
275	800	0	-15		.0232
276	800	0	-9		.1625
277**	800	0	0		.2321
277**	800	25	0		.1451
277**	800	76	0		.0406
277**	800	127	0		.0290
278	800	0	3		.1683
279	800	0	9		.0580
280	800	0	15		.0000
281	800	0	21		.0000

* POSITIVE ANGLES ARE CLOCKWISE DIRECTION.

** MODEL SAMPLE LOCATION HALFWAY TO NEXT HIGHEST GRID POINT.

CONCENTRATION DATA FOR RUN NO. 2
 STABILITY: NEUTRAL
 WIND DIRECTION: 45 DEG.
 RELEASE POINT: A

SAMPLER GRID POINT	PROTOTYPE		MODEL		CONCENTRATION COEFFICIENT
	ARC (M)	ELEV (M)	DEGREES OFF* CENTER LINE		
107	100	0	57		.0000
104	100	0	39		.0320
101	100	0	21		.2022
98	100	0	3		.8269
95	100	0	-15		1.6820
92	100	0	-33		1.1844
89	100	0	-51		.1918
86	100	0	-69		.0096
149	200	0	-51		.0090
151	200	0	-39		.0212
153	200	0	-27		.5109
155	200	0	-15		1.0152
157**	200	0	0		.5747
157**	200	25	0		.2507
157**	200	51	0		.0713
159	200	0	9		.2264
161	200	0	21		.0387
163	200	0	33		.0029
165	200	0	45		.0098
225	400	0	45		.0108
223	400	0	33		.0106
221	400	0	21		.0079
219	400	0	9		.0766
217**	400	0	0		.3346
217**	400	25	0		.2346
217**	400	51	0		.1035
216	400	0	-9		.3529
214	400	0	-21		.0224
212	400	0	-33		.0041
274	800	0	-21		.0000
275	800	0	-15		.0159
276	800	0	-9		.2246
277**	800	0	0		.2303
277**	800	25	0		.1353
277**	800	76	0		.0049
277**	800	127	0		.0173
279	800	0	9		.0165
280	800	0	15		.0063
281	800	0	21		.0143
282	800	0	27		.0061

* POSITIVE ANGLES ARE CLOCKWISE DIRECTION.

** MODEL SAMPLE LOCATION HALFWAY TO NEXT HIGHEST GRID POINT.

CONCENTRATION DATA FOR RUN NO. 11
 STABILITY: MODERATELY STABLE
 WIND DIRECTION: 45 DEG.
 RELEASE POINT: A

SAMPLER GRID POINT	PROTOTYPE		MODEL		CONCENTRATION COEFFICIENT
	ARC (M)	ELEV (M)	DEGREES OFF* CENTER LINE		
107	100	0	57		.0075
104	100	0	39		.1247
101	100	0	21		1.0442
98	100	0	3		2.3995
95	100	0	-15		3.0670
92	100	0	-33		2.3192
89	100	0	-51		.3011
86	100	0	-69		.0140
149	200	0	-51		.0073
151	200	0	-39		.0119
153	200	0	-27		.8379
155	200	0	-15		2.1860
157**	200	0	0		1.5866
157**	200	51	0		.0320
159	200	0	9		.6260
161	200	0	21		.1128
163	200	0	33		.0147
165	200	0	45		.0059
225	400	0	45		.0040
223	400	0	33		.0082
221	400	0	21		.0404
219	400	0	9		.5002
217**	400	0	0		1.0760
217**	400	25	0		.6220
217**	400	51	0		.1396
216	400	0	-9		.8841
214	400	0	-21		.0523
212	400	0	-33		.0089
274	800	0	-21		.0005
275	800	0	-15		.0194
276	800	0	-9		.2598
277**	800	0	0		.7922
277**	800	25	0		.3310
277**	800	76	0		.0224
277**	800	127	0		.0070
279	800	0	9		.6729
280	800	0	15		.1594
281	800	0	21		.0173
282	800	0	27		.0005

* POSITIVE ANGLES ARE CLOCKWISE DIRECTION.

** MODEL SAMPLE LOCATION HALFWAY TO NEXT HIGHEST GRID POINT.

CONCENTRATION DATA FOR RUN NO. 18
 STABILITY: SLIGHTLY UNSTABLE
 WIND DIRECTION: 45 DEG.
 RELEASE POINT: A

SAMPLER GRID POINT	PROTOTYPE		MODEL	
	ARC (M)	ELEV (M)	DEGREES OFF* CENTER LINE	CONCENTRATION COEFFICIENT
107	100	0	57	.0112
104	100	0	39	.0236
101	100	0	21	.4048
98	100	0	3	.9070
95	100	0	-15	2.3220
92	100	0	-33	1.2994
89	100	0	-51	.1935
86	100	0	-69	.0177
149	200	0	-51	.0201
151	200	0	-39	.0307
153	200	0	-27	.2809
155	200	0	-15	1.2221
157**	200	0	0	.8125
157**	200	25	0	.4721
157**	200	51	0	.1900
159	200	0	9	.3777
161	200	0	21	.0997
163	200	0	33	.0242
165	200	0	45	.0248
224	400	0	39	.0207
222	400	0	27	.0183
220	400	0	15	.0643
219	400	0	9	.1157
217**	400	0	0	.4325
217**	400	25	0	.3033
217**	400	51	0	.1428
216	400	0	-9	.5028
214	400	0	-21	.4260
212	400	0	-33	.0130
274	800	0	-21	.0212
275	800	0	-15	.0507
276	800	0	-9	.1965
277**	800	0	0	.2095
277**	800	25	0	.1493
277**	800	76	0	.0708
277**	800	127	0	.0466
278	800	0	3	.1475
279	800	0	9	.0572
280	800	0	15	.0236
281	800	0	21	.0000

* POSITIVE ANGLES ARE CLOCKWISE DIRECTION.

** MODEL SAMPLE LOCATION HALFWAY TO NEXT HIGHEST GRID POINT.

CONCENTRATION DATA FOR RUN NO. 2

STABILITY: NEUTRAL

WIND DIRECTION: 45 DEG.

RELEASE POINT: G5

SAMPLER GRID POINT	PROTOTYPE		MODEL	
	ARC (M)	ELEV (M)	DEGREES OFF* CENTER LINE	CONCENTRATION COEFFICIENT
107	100	0	57	.0052
104	100	0	39	.0410
101	100	0	21	.2440
98	100	0	3	.9361
95	100	0	-15	1.6108
92	100	0	-33	2.2352
89	100	0	-51	.7611
86	100	0	-69	.1918
149	200	0	-51	.0110
151	200	0	-39	.0768
153	200	0	-27	.6886
155	200	0	-15	1.2145
157**	200	0	0	.7389
157**	200	25	0	.3319
157**	200	51	0	.1048
159	200	0	9	.2971
161	200	0	21	.0429
163	200	0	33	.0062
165	200	0	45	.0072
225	400	0	45	.0091
223	400	0	33	.0081
221	400	0	21	.0091
219	400	0	9	.0903
217**	400	0	0	.4170
217**	400	25	0	.2633
217**	400	51	0	.1057
216	400	0	-9	.3184
214	400	0	-21	.0313
212	400	0	-33	.0081
274	800	0	-21	.0120
275	800	0	-15	.0168
276	800	0	-9	.2382
277**	800	0	0	.2353
277**	800	25	0	.1444
277**	800	76	0	.0478
277**	800	127	0	.0159
279	800	0	9	.0120
280	800	0	15	.0081
281	800	0	21	.0159
282	800	0	27	.0120

* POSITIVE ANGLES ARE CLOCKWISE DIRECTION.

** MODEL SAMPLE LOCATION HALFWAY TO NEXT HIGHEST GRID POINT.

CONCENTRATION DATA FOR RUN NO. 11
 STABILITY: MODERATELY STABLE
 WIND DIRECTION: 45 DEG.
 RELEASE POINT: G5

SAMPLER GRID POINT	PROTOTYPE		MODEL	
	ARC (M)	ELEV (M)	DEGREES OFF* CENTER LINE	CONCENTRATION COEFFICIENT
107	100	0	57	.0040
104	100	0	39	.0921
101	100	0	21	.9045
98	100	0	3	2.2913
95	100	0	-15	2.7771
92	100	0	-33	3.5878
89	100	0	-51	2.2021
86	100	0	-69	1.6327
149	200	0	-51	.0332
151	200	0	-39	.3737
153	200	0	-27	2.2453
155	200	0	-15	2.1656
157**	200	0	0	1.5676
157**	200	51	0	.0203
159	200	0	9	.5578
161	200	0	21	.0820
163	200	0	33	.0040
165	200	0	45	.0000
225	400	0	45	.0000
223	400	0	33	.0001
221	400	0	21	.0175
219	400	0	9	.4450
217**	400	0	0	.8837
217**	400	25	0	.5129
217**	400	51	0	.1000
216	400	0	-9	1.0436
214	400	0	-21	.2711
212	400	0	-33	.0130
274	800	0	-21	.0000
275	800	0	-15	.0641
276	800	0	-9	.4686
277**	800	0	0	.6924
277**	800	25	0	.2666
277**	800	76	0	.0136
277**	800	127	0	.0001
279	800	0	9	.5522
280	800	0	15	.1224
281	800	0	21	.0074
282	800	0	27	.0000

* POSITIVE ANGLES ARE CLOCKWISE DIRECTION.

** MODEL SAMPLE LOCATION HALFWAY TO NEXT HIGHEST GRID POINT.

CONCENTRATION DATA FOR RUN NO. 18

STABILITY: SLIGHTLY UNSTABLE

WIND DIRECTION: 45 DEG.

RELEASE POINT: G5

SAMPLER GRID POINT	PROTOTYPE		MODEL		CONCENTRATION COEFFICIENT
	ARC (M)	ELEV (M)	DEGREES OFF* CENTER LINE		
107	100	0	57		.0164
104	100	0	39		.0252
101	100	0	21		.6938
98	100	0	3		1.5437
95	100	0	-15		3.1756
92	100	0	-33		1.5337
89	100	0	-51		.3941
86	100	0	-69		.0642
149	200	0	-51		.0151
151	200	0	-39		.0453
153	200	0	-27		.3375
155	200	0	-15		1.7389
157**	200	0	0		1.4619
157**	200	25	0		.8386
157**	200	51	0		.3223
159	200	0	9		.7013
161	200	0	21		.1637
163	200	0	33		.0290
165	200	0	45		.0151
224	400	0	39		.0176
222	400	0	27		.0126
220	400	0	15		.0693
219	400	0	9		.1989
217**	400	0	0		.7215
217**	400	25	0		.4659
217**	400	51	0		.1826
216	400	0	-9		.7731
214	400	0	-21		.6044
212	400	0	-33		.0227
274	800	0	-21		.0239
275	800	0	-15		.0705
276	800	0	-9		.2909
277**	800	0	0		.3148
277**	800	25	0		.2178
277**	800	76	0		.0894
277**	800	127	0		.0630
278	800	0	3		.2166
279	800	0	9		.1221
280	800	0	15		.0164
281	800	0	21		.0252

* POSITIVE ANGLES ARE CLOCKWISE DIRECTION.

** MODEL SAMPLE LOCATION HALFWAY TO NEXT HIGHEST GRID POINT.

CONCENTRATION DATA FOR RUN NO. 2

STABILITY: NEUTRAL

WIND DIRECTION: 45 DEG.

RELEASE POINT: G17

SAMPLER GRID POINT	PROTOTYPE		MODEL		CONCENTRATION COEFFICIENT
	ARC (M)	ELEV (M)	DEGREES OFF* CENTER LINE		
107	100	0	57		.0399
104	100	0	39		.2392
101	100	0	21		.9534
98	100	0	3		2.2296
95	100	0	-15		2.3870
92	100	0	-33		.6823
89	100	0	-51		.1369
86	100	0	-69		.0081
149	200	0	-51		.0090
151	200	0	-39		.0390
153	200	0	-27		.3414
155	200	0	-15		1.3157
157**	200	0	0		1.3409
157**	200	25	0		.6395
157**	200	51	0		.1498
159	200	0	9		.7960
161	200	0	21		.1778
163	200	0	33		.0100
165	200	0	45		.0090
225	400	0	45		.0124
223	400	0	33		.0086
221	400	0	21		.0090
219	400	0	9		.1911
217**	400	0	0		.5587
217**	400	25	0		.3072
217**	400	51	0		.1241
216	400	0	-9		.3528
214	400	0	-21		.0176
212	400	0	-33		.0086
274	800	0	-21		.0100
275	800	0	-15		.0195
276	800	0	-9		.2197
277**	800	0	0		.2772
277**	800	25	0		.1664
277**	800	76	0		.0575
277**	800	127	0		.0185
279	800	0	9		.0195
280	800	0	15		.0095
281	800	0	21		.0200
282	800	0	27		.0109

* POSITIVE ANGLES ARE CLOCKWISE DIRECTION.

** MODEL SAMPLE LOCATION HALFWAY TO NEXT HIGHEST GRID POINT.

CONCENTRATION DATA FOR RUN NO. 11

STABILITY: MODERATELY STABLE

WIND DIRECTION: 45 DEG.

RELEASE POINT: G17

SAMPLER GRID POINT	PROTOTYPE		MODEL		CONCENTRATION COEFFICIENT
	ARC (M)	ELEV (M)	DEGREES OFF* CENTER LINE		
107	100	0	57		.0404
104	100	0	39		.2803
101	100	0	21		2.3808
98	100	0	3		4.0770
95	100	0	-15		3.9779
92	100	0	-33		.9805
89	100	0	-51		.1239
86	100	0	-69		.0013
149	200	0	-51		.0000
151	200	0	-39		.0013
153	200	0	-27		.3612
155	200	0	-15		1.4707
157**	200	0	0		2.6832
157**	200	51	0		.0495
159	200	0	9		1.5646
161	200	0	21		.2503
163	200	0	33		.0183
165	200	0	45		.0000
225	400	0	45		.0000
223	400	0	33		.0039
221	400	0	21		.0691
219	400	0	9		.9479
217**	400	0	0		1.2934
217**	400	25	0		.8279
217**	400	51	0		.1382
216	400	0	-9		.6962
214	400	0	-21		.0261
212	400	0	-33		.0013
274	800	0	-21		.0013
275	800	0	-15		.0130
276	800	0	-9		.1734
277**	800	0	0		.7093
277**	800	25	0		.3025
277**	800	76	0		.0169
277**	800	127	0		.0039
279	800	0	9		.7236
280	800	0	15		.3077
281	800	0	21		.0248
282	800	0	27		.0000

* POSITIVE ANGLES ARE CLOCKWISE DIRECTION.

** MODEL SAMPLE LOCATION HALFWAY TO NEXT HIGHEST GRID POINT.

CONCENTRATION DATA FOR RUN NO. 18
 STABILITY: SLIGHTLY UNSTABLE
 WIND DIRECTION: 45 DEG.
 RELEASE POINT: G17

SAMPLER GRID POINT	PROTOTYPE ARC (M)	ELEV (M)	MODEL DEGREES OFF* CENTER LINE	CONCENTRATION COEFFICIENT
107	100	0	57	.0280
104	100	0	39	.0530
101	100	0	21	1.3865
98	100	0	3	2.4925
95	100	0	-15	3.0876
92	100	0	-33	.6948
89	100	0	-51	.1433
86	100	0	-69	.0280
149	200	0	-51	.0343
151	200	0	-39	.0561
153	200	0	-27	.1869
155	200	0	-15	1.2587
157**	200	0	0	1.5204
157**	200	25	0	.6449
157**	200	51	0	.2461
159	200	0	9	.9690
161	200	0	21	.3147
163	200	0	33	.0499
165	200	0	45	.0312
224	400	0	39	.0374
222	400	0	27	.0343
220	400	0	15	.1184
219	400	0	9	.2586
217**	400	0	0	.6387
217**	400	25	0	.4082
217**	400	51	0	.1807
216	400	0	-9	.5608
214	400	0	-21	.4144
212	400	0	-33	.0405
274	800	0	-21	.0561
275	800	0	-15	.0654
276	800	0	-9	.2119
277**	800	0	0	.2742
277**	800	25	0	.1994
277**	800	76	0	.0872
277**	800	127	0	.0748
278	800	0	3	.2337
279	800	0	9	.1059
280	800	0	15	.0343
281	800	0	21	.0499

* POSITIVE ANGLES ARE CLOCKWISE DIRECTION.

** MODEL SAMPLE LOCATION HALFWAY TO NEXT HIGHEST GRID POINT.

Table 8. Data, Wind Direction 90°

CONCENTRATION DATA FOR RUN NO. 3
 STABILITY: NEUTRAL
 WIND DIRECTION: 90 DEG.
 RELEASE POINT: C

SAMPLER GRID POINT	PROTOTYPE		MODEL		CONCENTRATION COEFFICIENT
	ARC (M)	ELEV (M)	DEGREES OFF* CENTER LINE		
115	100	0	60		.0175
112	100	0	42		.0175
109	100	0	24		.0254
106	100	0	6		.2934
104	100	0	-6		3.5846
101	100	0	-24		2.8642
98	100	0	-42		.0254
95	100	0	-60		.0201
157	200	0	-48		.0188
159	200	0	-36		.1378
161	200	0	-24		.0489
163	200	0	-12		1.6912
165	200	0	0		1.9972
165	200	25	0		.6125
165	200	51	0		.1875
167	200	0	12		.0855
169	200	0	24		.0188
171	200	0	36		.0175
173	200	0	48		.0175
233	400	0	48		.0188
231	400	0	36		.0214
229	400	0	24		.0175
227	400	0	12		.0254
225	400	0	0		.9145
225	400	25	0		.4791
225	400	51	0		.1640
223	400	0	-12		.2019
221	400	0	-24		.0201
219	400	0	-36		.0188
281	800	0	-24		.0188
283	800	0	-12		.0398
284	800	0	-6		.3732
285	800	0	0		.4111
285	800	25	0		.2568
285	800	76	0		.1038
285	800	127	0		.0228
286	800	0	6		.0476
287	800	0	12		.0214
288	800	0	18		.0280
289	800	0	24		.0175

* POSITIVE ANGLES ARE CLOCKWISE DIRECTION.

** MODEL SAMPLE LOCATION HALFWAY TO NEXT HIGHEST GRID POINT.

CONCENTRATION DATA FOR RUN NO. 12
 STABILITY: MODERATELY STABLE
 WIND DIRECTION: 90 DEG.
 RELEASE POINT: C

SAMPLER GRID POINT	PROTOTYPE		MODEL		CONCENTRATION COEFFICIENT
	ARC (M)	ELEV (M)	DEGREES OFF* CENTER LINE		
115	100	0	60		.0023
112	100	0	42		.0000
109	100	0	24		.0542
106	100	0	6		6.5967
104	100	0	-6		3.9768
101	100	0	-24		3.6655
98	100	0	-42		.0225
95	100	0	-60		.0081
157	200	0	-48		.0081
159	200	0	-36		.0081
161	200	0	-24		.2819
163	200	0	-12		2.8326
165	200	0	0		3.6597
165	200	25	0		1.6509
165	200	51	0		.1061
167	200	0	12		2.5847
169	200	0	24		.0974
171	200	0	36		.0081
173	200	0	48		.0023
233	400	0	48		.0023
231	400	0	36		.0052
229	400	0	24		.0369
227	400	0	12		.6104
225	400	0	0		1.7143
225	400	25	0		1.1552
225	400	51	0		.1118
223	400	0	-12		.2271
221	400	0	-24		.0196
219	400	0	-36		.0110
281	800	0	-24		.0138
283	800	0	-12		.0167
284	800	0	-6		.1925
285	800	0	0		.6306
285	800	25	0		.3683
285	800	76	0		.0311
285	800	127	0		.0196
286	800	0	6		.8035
287	800	0	12		.3626
288	800	0	18		.0455
289	800	0	24		.0196

* POSITIVE ANGLES ARE CLOCKWISE DIRECTION.

** MODEL SAMPLE LOCATION HALFWAY TO NEXT HIGHEST GRID POINT.

CONCENTRATION DATA FOR RUN NO. 19
 STABILITY: SLIGHTLY UNSTABLE
 WIND DIRECTION: 90 DEG.
 RELEASE POINT: C

SAMPLER GRID POINT	PROTOTYPE ARC (M)	ELEV (M)	MODEL DEGREES OFF* CENTER LINE	CONCENTRATION COEFFICIENT
115	100	0	60	.0000
112	100	0	42	.0000
109	100	0	24	.0116
106	100	0	6	1.7294
104	100	0	-6	3.8185
101	100	0	-24	2.4606
98	100	0	-42	.0116
95	100	0	-60	.0000
157	200	0	-48	.0000
159	200	0	-36	.0000
161	200	0	-24	.0580
163	200	0	-12	1.7526
165	200	0	0	1.8164
165	200	25	0	.6558
165	200	51	0	.2263
167	200	0	12	.4410
169	200	0	24	.0116
171	200	0	36	.0000
173	200	0	48	.0000
232	400	0	42	.0000
230	400	0	30	.0000
228	400	0	18	.0406
226	400	0	6	.6558
225	400	0	0	.8415
225	400	25	0	.4468
225	400	51	0	.0929
224	400	0	-6	.7196
222	400	0	-18	.4004
220	400	0	-30	.0000
282	800	0	-18	.0000
283	800	0	-12	.0232
284	800	0	-6	.2379
285	800	0	0	.2786
285	800	25	0	.1509
285	800	76	0	.0406
285	800	127	0	.0116
286	800	0	6	.1509
287	800	0	12	.0232
288	800	0	18	.0000
289	800	0	24	.0000

* POSITIVE ANGLES ARE CLOCKWISE DIRECTION.

** MODEL SAMPLE LOCATION HALFWAY TO NEXT HIGHEST GRID POINT.

CONCENTRATION DATA FOR RUN NO. 3
 STABILITY: NEUTRAL
 WIND DIRECTION: 90 DEG.
 RELEASE POINT: A

SAMPLER GRID POINT	PROTOTYPE		MODEL		CONCENTRATION COEFFICIENT
	ARC (M)	ELEV (M)	DEGREES OFF* CENTER LINE		
115	100	0	60		.0094
112	100	0	42		.0102
109	100	0	24		.0126
106	100	0	6		.0970
104	100	0	-6		.8062
101	100	0	-24		2.1073
98	100	0	-42		.2682
95	100	0	-60		.0181
157	200	0	-48		.0151
159	200	0	-36		.0797
161	200	0	-24		.2667
163	200	0	-12		.9869
165	200	0	0		.5480
165	200	25	0		.1761
165	200	51	0		.0583
167	200	0	12		.0234
169	200	0	24		.0151
171	200	0	36		.0147
173	200	0	48		.0173
233	400	0	48		.0183
231	400	0	36		.0181
229	400	0	24		.0161
227	400	0	12		.0171
225	400	0	0		.4781
225	400	25	0		.2674
225	400	51	0		.1612
223	400	0	-12		.2490
221	400	0	-24		.0263
219	400	0	-36		.0157
281	800	0	-24		.0149
283	800	0	-12		.0316
284	800	0	-6		.3403
285	800	0	0		.3238
285	800	25	0		.2117
285	800	76	0		.1043
285	800	127	0		.0242
286	800	0	6		.0324
287	800	0	12		.0159
288	800	0	18		.0002
289	800	0	24		.0147

* POSITIVE ANGLES ARE CLOCKWISE DIRECTION.

** MODEL SAMPLE LOCATION HALFWAY TO NEXT HIGHEST GRID POINT.

CONCENTRATION DATA FOR RUN NO. 12
 STABILITY: MODERATELY STABLE
 WIND DIRECTION: 90 DEG.
 RELEASE POINT: A

SAMPLER GRID POINT	PROTOTYPE ARC (M)	ELEV (M)	MODEL DEGREES OFF* CENTER LINE	CONCENTRATION COEFFICIENT
115	100	0	60	.0117
112	100	0	42	.0079
109	100	0	24	.2026
106	100	0	6	2.5533
104	100	0	-6	1.5875
101	100	0	-24	3.0357
98	100	0	-42	.0791
95	100	0	-60	.0217
157	200	0	-48	.0126
159	200	0	-36	.0278
161	200	0	-24	.4871
163	200	0	-12	2.2550
165	200	0	0	1.9288
165	200	25	0	.6537
165	200	51	0	.0672
167	200	0	12	1.1411
169	200	0	24	.0901
171	200	0	36	.0159
173	200	0	48	.0128
233	400	0	48	.0082
231	400	0	36	.0112
229	400	0	24	.0299
227	400	0	12	.2857
225	400	0	0	1.3383
225	400	25	0	1.1114
225	400	51	0	.1186
223	400	0	-12	.3907
221	400	0	-24	.0173
219	400	0	-36	.0098
281	800	0	-24	.0000
283	800	0	-12	.0112
284	800	0	-6	.2817
285	800	0	0	.8383
285	800	25	0	.4761
285	800	76	0	.0383
285	800	127	0	.0154
286	800	0	6	.5879
287	800	0	12	.2012
288	800	0	18	.0259
289	800	0	24	.0000

* POSITIVE ANGLES ARE CLOCKWISE DIRECTION.

** MODEL SAMPLE LOCATION HALFWAY TO NEXT HIGHEST GRID POINT.

CONCENTRATION DATA FOR RUN NO. 19
 STABILITY: SLIGHTLY UNSTABLE
 WIND DIRECTION: 90 DEG.
 RELEASE POINT: A

SAMPLER GRID POINT	PROTOTYPE		MODEL		CONCENTRATION COEFFICIENT
	ARC (M)	ELEV (M)	DEGREES OFF* CENTER LINE		
115	100	0	60		.0094
112	100	0	42		.0112
109	100	0	24		.0177
106	100	0	6		.3989
104	100	0	-6		1.2179
101	100	0	-24		2.5108
98	100	0	-42		.1027
95	100	0	-60		.0148
157	200	0	-48		.0124
159	200	0	-36		.0266
161	200	0	-24		.2107
163	200	0	-12		1.0350
165	200	0	0		.7860
165	200	25	0		.5972
165	200	51	0		.2455
167	200	0	12		.1157
169	200	0	24		.0201
171	200	0	36		.0177
173	200	0	48		.0195
232	400	0	42		.0207
230	400	0	30		.0106
228	400	0	18		.0319
226	400	0	6		.3529
225	400	0	0		.6048
225	400	25	0		.3883
225	400	51	0		.1334
224	400	0	-6		.6031
222	400	0	-18		.3924
220	400	0	-30		.0201
282	800	0	-18		.0159
283	800	0	-12		.0543
284	800	0	-6		.2478
285	800	0	0		.2526
285	800	25	0		.1664
285	800	76	0		.0602
285	800	127	0		.0342
286	800	0	6		.1145
287	800	0	12		.0437
288	800	0	18		.0153
289	800	0	24		.0195

* POSITIVE ANGLES ARE CLOCKWISE DIRECTION.

** MODEL SAMPLE LOCATION HALFWAY TO NEXT HIGHEST GRID POINT.

CONCENTRATION DATA FOR RUN NO. 3
 STABILITY: NEUTRAL
 WIND DIRECTION: 90 DEG.
 RELEASE POINT: G5

SAMPLER GRID POINT	PROTOTYPE		MODEL		CONCENTRATION COEFFICIENT
	ARC (M)	ELEV (M)	DEGREES OFF* CENTER LINE		
115	100	0	60		.0255
112	100	0	42		.0449
109	100	0	24		.1444
106	100	0	6		.1560
104	100	0	-6		.6761
101	100	0	-24		2.3947
98	100	0	-42		1.8747
95	100	0	-60		1.3508
157	200	0	-48		.0410
159	200	0	-36		.1589
161	200	0	-24		.6674
163	200	0	-12		1.0501
165	200	0	0		.4334
165	200	25	0		.1869
165	200	51	0		.0661
167	200	0	12		.0787
169	200	0	24		.0226
171	200	0	36		.0178
173	200	0	48		.0217
233	400	0	48		.0197
231	400	0	36		.0207
229	400	0	24		.0197
227	400	0	12		.0236
225	400	0	0		.4218
225	400	25	0		.2546
225	400	51	0		.1212
223	400	0	-12		.3029
221	400	0	-24		.0526
219	400	0	-36		.0217
281	800	0	-24		.0284
283	800	0	-12		.0478
284	800	0	-6		.3696
285	800	0	0		.2855
285	800	25	0		.1956
285	800	76	0		.0922
285	800	127	0		.0275
286	800	0	6		.0323
287	800	0	12		.0226
288	800	0	18		.0294
289	800	0	24		.0236

* POSITIVE ANGLES ARE CLOCKWISE DIRECTION.

** MODEL SAMPLE LOCATION HALFWAY TO NEXT HIGHEST GRID POINT.

CONCENTRATION DATA FOR RUN NO. 12
 STABILITY: MODERATELY STABLE
 WIND DIRECTION: 90 DEG.
 RELEASE POINT: G5

SAMPLER GRID POINT	PROTOTYPE		MODEL	
	ARC (M)	ELEV (M)	DEGREES OFF* CENTER LINE	CONCENTRATION COEFFICIENT
115	100	0	60	.0511
112	100	0	42	.2816
109	100	0	24	1.0822
106	100	0	6	.9902
104	100	0	-6	1.1428
101	100	0	-24	1.8755
98	100	0	-42	2.5577
95	100	0	-60	2.9577
157	200	0	-48	.3865
159	200	0	-36	1.6197
161	200	0	-24	1.8878
163	200	0	-12	.9234
165	200	0	0	.7063
165	200	25	0	.2951
165	200	51	0	.0196
167	200	0	12	.7753
169	200	0	24	.3557
171	200	0	36	.1201
173	200	0	48	.0202
233	400	0	48	.0000
231	400	0	36	.0000
229	400	0	24	.0578
227	400	0	12	.3411
225	400	0	0	.5375
225	400	25	0	.3888
225	400	51	0	.0325
223	400	0	-12	.6216
221	400	0	-24	.2929
219	400	0	-36	.0185
281	800	0	-24	.0034
283	800	0	-12	.0303
284	800	0	-6	.3804
285	800	0	0	.5015
285	800	25	0	.2519
285	800	76	0	.0112
285	800	127	0	.0034
286	800	0	6	.2738
287	800	0	12	.1745
288	800	0	18	.0224
289	800	0	24	.0000

* POSITIVE ANGLES ARE CLOCKWISE DIRECTION.

** MODEL SAMPLE LOCATION HALFWAY TO NEXT HIGHEST GRID POINT.

CONCENTRATION DATA FOR RUN NO. 19
 STABILITY: SLIGHTLY UNSTABLE
 WIND DIRECTION: 90 DEG.
 RELEASE POINT: G5

SAMPLER GRID POINT	PROTOTYPE		MODEL		CONCENTRATION COEFFICIENT
	ARC (M)	ELEV (M)	DEGREES OFF* CENTER LINE		
115	100	0	60		.0101
112	100	0	42		.0201
109	100	0	24		.1335
106	100	0	6		.5641
104	100	0	-6		1.3171
101	100	0	-24		2.7424
98	100	0	-42		1.8812
95	100	0	-60		1.6495
157	200	0	-48		.0516
159	200	0	-36		.4961
161	200	0	-24		.8235
163	200	0	-12		1.1773
165	200	0	0		.8373
165	200	25	0		.5767
165	200	51	0		.2367
167	200	0	12		.2128
169	200	0	24		.0290
171	200	0	36		.0151
173	200	0	48		.0139
232	400	0	42		.0176
230	400	0	30		.0201
228	400	0	18		.0516
226	400	0	6		.4407
225	400	0	0		.7467
225	400	25	0		.4596
225	400	51	0		.1473
224	400	0	-6		.8273
222	400	0	-18		.7630
220	400	0	-30		.0730
282	800	0	-18		.0290
283	800	0	-12		.1108
284	800	0	-6		.3815
285	800	0	0		.3198
285	800	25	0		.2027
285	800	76	0		.0793
285	800	127	0		.0441
286	800	0	6		.1322
287	800	0	12		.0390
288	800	0	18		.0214
289	800	0	24		.0227

* POSITIVE ANGLES ARE CLOCKWISE DIRECTION.

** MODEL SAMPLE LOCATION HALFWAY TO NEXT HIGHEST GRID POINT.

CONCENTRATION DATA FOR RUN NO. 3
 STABILITY: NEUTRAL
 WIND DIRECTION: 90 DEG.
 RELEASE POINT: G17

SAMPLER GRID POINT	PROTOTYPE		MODEL		CONCENTRATION COEFFICIENT
	ARC (M)	ELEV (M)	DEGREES OFF* CENTER LINE		
115	100	0	60		.0132
112	100	0	42		.0311
109	100	0	24		.3430
106	100	0	6		.4057
104	100	0	-6		2.5845
101	100	0	-24		2.3942
98	100	0	-42		.0615
95	100	0	-60		.0185
157	200	0	-48		.0178
159	200	0	-36		.1375
161	200	0	-24		.0747
163	200	0	-12		1.2767
165	200	0	0		1.5800
165	200	25	0		.8062
165	200	51	0		.2524
167	200	0	12		.1705
169	200	0	24		.0192
171	200	0	36		.0172
173	200	0	48		.0185
233	400	0	48		.0185
231	400	0	36		.0178
229	400	0	24		.0178
227	400	0	12		.0330
225	400	0	0		.8941
225	400	25	0		.5280
225	400	51	0		.2121
223	400	0	-12		.1989
221	400	0	-24		.0192
219	400	0	-36		.0185
281	800	0	-24		.0165
283	800	0	-12		.0383
284	800	0	-6		.3635
285	800	0	0		.4322
285	800	25	0		.2729
285	800	76	0		.1156
285	800	127	0		.0231
286	800	0	6		.0542
287	800	0	12		.0218
288	800	0	18		.0278
289	800	0	24		.0172

* POSITIVE ANGLES ARE CLOCKWISE DIRECTION.

** MODEL SAMPLE LOCATION HALFWAY TO NEXT HIGHEST GRID POINT.

CONCENTRATION DATA FOR RUN NO. 12
 STABILITY: MODERATELY STABLE
 WIND DIRECTION: 90 DEG.
 RELEASE POINT: G17

SAMPLER GRID POINT	PROTOTYPE		MODEL		CONCENTRATION COEFFICIENT
	ARC (M)	ELEV (M)	DEGREES OFF* CENTER LINE		
115	100	0	60		.0000
112	100	0	42		.0022
109	100	0	24		2.0753
106	100	0	6		4.2813
104	100	0	-6		4.4965
101	100	0	-24		2.7454
98	100	0	-42		.0113
95	100	0	-60		.0009
157	200	0	-48		.0000
159	200	0	-36		.0000
161	200	0	-24		.2043
163	200	0	-12		2.3139
165	200	0	0		3.2696
165	200	25	0		1.3621
165	200	51	0		.0922
167	200	0	12		3.1627
169	200	0	24		.4638
171	200	0	36		.0074
173	200	0	48		.0000
233	400	0	48		.0000
231	400	0	36		.0000
229	400	0	24		.0752
227	400	0	12		.9501
225	400	0	0		1.2578
225	400	25	0		.8706
225	400	51	0		.0791
223	400	0	-12		.2017
221	400	0	-24		.0048
219	400	0	-36		.0035
281	800	0	-24		.0257
283	800	0	-12		.0205
284	800	0	-6		.1495
285	800	0	0		.4781
285	800	25	0		.2721
285	800	76	0		.0166
285	800	127	0		.0035
286	800	0	6		.7141
287	800	0	12		.4403
288	800	0	18		.0426
289	800	0	24		.0035

* POSITIVE ANGLES ARE CLOCKWISE DIRECTION.

** MODEL SAMPLE LOCATION HALFWAY TO NEXT HIGHEST GRID POINT.

CONCENTRATION DATA FOR RUN NO. 19
 STABILITY: SLIGHTLY UNSTABLE
 WIND DIRECTION: 90 DEG.
 RELEASE POINT: G17

SAMPLER GRID POINT	PROTOTYPE		MODEL		CONCENTRATION COEFFICIENT
	ARC (M)	ELEV (M)	DEGREES OFF* CENTER LINE		
115	100	0	60		.0249
112	100	0	42		.0249
109	100	0	24		.1433
106	100	0	6		1.3242
104	100	0	-6		2.2962
101	100	0	-24		1.9660
98	100	0	-42		.0405
95	100	0	-60		.0249
157	200	0	-48		.0280
159	200	0	-36		.0405
161	200	0	-24		.1059
163	200	0	-12		1.2463
165	200	0	0		1.2494
165	200	25	0		.7166
165	200	51	0		.2991
167	200	0	12		.3552
169	200	0	24		.0405
171	200	0	36		.0343
173	200	0	48		.0280
232	400	0	42		.0405
230	400	0	30		.0312
228	400	0	18		.0654
226	400	0	6		.5920
225	400	0	0		.7509
225	400	25	0		.4487
225	400	51	0		.1651
224	400	0	-6		.6948
222	400	0	-18		.3863
220	400	0	-30		.0374
282	800	0	-18		.0343
283	800	0	-12		.0654
284	800	0	-6		.2648
285	800	0	0		.2929
285	800	25	0		.1994
285	800	76	0		.0872
285	800	127	0		.0592
286	800	0	6		.1682
287	800	0	12		.0623
288	800	0	18		.0436
289	800	0	24		.0530

* POSITIVE ANGLES ARE CLOCKWISE DIRECTION.

** MODEL SAMPLE LOCATION HALFWAY TO NEXT HIGHEST GRID POINT.

Table 9. Data, Wind Direction 135°

CONCENTRATION DATA FOR RUN NO. 4
 STABILITY: NEUTRAL
 WIND DIRECTION: 135 DEG.
 RELEASE POINT: C

SAMPLER GRID POINT	PROTOTYPE		MODEL		CONCENTRATION COEFFICIENT
	ARC (M)	ELEV (M)	DEGREES OFF* CENTER LINE		
120	100	0	45		.0022
117	100	0	27		.0212
114	100	0	9		.3441
112	100	0	-3		1.5550
109	100	0	-21		2.2918
106	100	0	-39		1.1736
103	100	0	-57		.7350
100	100	0	-75		.0000
164	200	0	-51		.0144
166	200	0	-39		.1847
168	200	0	-27		1.0646
170	200	0	-15		1.3357
172**	200	0	0		.9665
172**	200	25	0		.7677
172**	200	51	0		.2242
174	200	0	9		.1752
176	200	0	21		.0000
178	200	0	33		.0000
121	200	0	51		.1302
238	400	0	33		.0000
236	400	0	21		.0049
235	400	0	15		.1370
234	400	0	9		.3468
232**	400	0	0		.4639
232**	400	25	0		.2760
232**	400	51	0		.1275
231	400	0	-9		.3509
229	400	0	-21		.5102
227	400	0	-33		.0240
289	800	0	-21		.0008
290	800	0	-15		.0825
291	800	0	-9		.1888
292**	800	0	0		.1561
292**	800	25	0		.1016
292**	800	76	0		.0512
292**	800	127	0		.0117
294	800	0	9		.1111
295	800	0	15		.0131
296	800	0	21		.0063
297	800	0	27		.0000

* POSITIVE ANGLES ARE CLOCKWISE DIRECTION.

** MODEL SAMPLE LOCATION HALFWAY TO NEXT HIGHEST GRID POINT.

CONCENTRATION DATA FOR RUN NO. 13
 STABILITY: MODERATELY STABLE
 WIND DIRECTION: 135 DEG.
 RELEASE POINT: C

SAMPLER GRID POINT	PROTOTYPE		MODEL		CONCENTRATION COEFFICIENT
	ARC (M)	ELEV (M)	DEGREES OFF* CENTER LINE		
120	100	0	45		.0115
117	100	0	27		.0000
114	100	0	9		.0432
112	100	0	-3		.4813
109	100	0	-21		1.3027
106	100	0	-39		.6370
103	100	0	-57		.3977
100	100	0	-75		.0058
164	200	0	-51		.0346
166	200	0	-39		.0576
168	200	0	-27		.9165
170	200	0	-15		1.3690
172**	200	0	0		1.3200
172**	200	25	0		1.8936
172**	200	51	0		.9770
174	200	0	9		.0317
176	200	0	21		.0519
178	200	0	33		.0000
121	200	0	51		.0000
238	400	0	33		.0000
236	400	0	21		.0000
235	400	0	15		.2104
234	400	0	9		.7465
232**	400	0	0		.6571
232**	400	25	0		.3459
232**	400	51	0		.1326
231	400	0	-9		.2767
229	400	0	-21		.4093
227	400	0	-33		.0461
289	800	0	-21		.0000
290	800	0	-15		.0548
291	800	0	-9		.1441
292**	800	0	0		.2104
292**	800	25	0		.1441
292**	800	76	0		.0346
292**	800	127	0		.0029
294	800	0	9		.1614
295	800	0	15		.0058
296	800	0	21		.0000
297	800	0	27		.0000

* POSITIVE ANGLES ARE CLOCKWISE DIRECTION.

** MODEL SAMPLE LOCATION HALFWAY TO NEXT HIGHEST GRID POINT.

CONCENTRATION DATA FOR RUN NO. 20

STABILITY: SLIGHTLY UNSTABLE

WIND DIRECTION: 135 DEG.

RELEASE POINT: C

SAMPLER GRID POINT	PROTOTYPE		MODEL		CONCENTRATION COEFFICIENT
	ARC (M)	ELEV (M)	DEGREES OFF* CENTER LINE		
120	100	0	45		.0000
117	100	0	27		.0859
114	100	0	9		.5269
112**	100	0	0		1.3626
109	100	0	-21		2.4884
106	100	0	-39		1.4090
103	100	0	-57		1.0202
100	100	0	-75		.0801
164	200	0	-51		.0975
166	200	0	-39		.3064
168	200	0	-27		.9854
170	200	0	-15		1.3394
172**	200	0	0		.9041
172**	200	25	0		.6430
172**	200	51	0		.2716
174	200	0	9		.3877
176	200	0	21		.1903
178	200	0	33		.0569
121	200	0	51		.0395
239	400	0	39		.0511
237	400	0	27		.0395
235	400	0	15		.1729
234	400	0	9		.3528
232**	400	0	0		.4225
232**	400	25	0		.3122
232**	400	51	0		.1555
231	400	0	-9		.3470
229	400	0	-21		.4457
227	400	0	-33		.3180
289	800	0	-21		.0743
290	800	0	-15		.1439
291	800	0	-9		.1613
292**	800	0	0		.1323
292**	800	25	0		.1265
292**	800	76	0		.1091
292**	800	127	0		.0569
293	800	0	3		.1381
294	800	0	9		.1091
295	800	0	15		.0917
296	800	0	21		.0221

* POSITIVE ANGLES ARE CLOCKWISE DIRECTION.

** MODEL SAMPLE LOCATION HALFWAY TO NEXT HIGHEST GRID POINT.

CONCENTRATION DATA FOR RUN NO. 4
 STABILITY: NEUTRAL
 WIND DIRECTION: 135 DEG.
 RELEASE POINT: A

SAMPLER GRID POINT	PROTOTYPE		MODEL		CONCENTRATION COEFFICIENT
	ARC (M)	ELEV (M)	DEGREES OFF* CENTER LINE		
120	100	0	45		.0058
117	100	0	27		.0620
114	100	0	9		.2615
112	100	0	-3		.7262
109	100	0	-21	1	.1524
106	100	0	-39		.8631
103	100	0	-57		.6409
100	100	0	-75		.0068
164	200	0	-51		.0253
166	200	0	-39		.1422
168	200	0	-27		.6545
170	200	0	-15		.8510
172**	200	0	0		.6606
172**	200	25	0		.7258
172**	200	51	0		.4002
174	200	0	9		.1382
176	200	0	21		.0075
178	200	0	33		.0128
121	200	0	51		.1236
238	400	0	33		.0142
236	400	0	21		.0172
235	400	0	15		.1350
234	400	0	9		.3371
232**	400	0	0		.4396
232**	400	25	0		.3210
232**	400	51	0		.1698
231	400	0	-9		.3051
229	400	0	-21		.3704
227	400	0	-33		.0336
289	800	0	-21		.0117
290	800	0	-15		.0703
291	800	0	-9		.1592
292**	800	0	0		.1728
292**	800	25	0		.1170
292**	800	76	0		.0669
292**	800	127	0		.0278
294	800	0	9		.1276
295	800	0	15		.0274
296	800	0	21		.0176
297	800	0	27		.0111

* POSITIVE ANGLES ARE CLOCKWISE DIRECTION.

** MODEL SAMPLE LOCATION HALFWAY TO NEXT HIGHEST GRID POINT.

CONCENTRATION DATA FOR RUN NO. 13
 STABILITY: MODERATELY STABLE
 WIND DIRECTION: 135 DEG.
 RELEASE POINT: A

SAMPLER GRID POINT	PROTOTYPE		MODEL		CONCENTRATION COEFFICIENT
	ARC (M)	ELEV (M)	DEGREES OFF* CENTER LINE		
120	100	0	45		.0175
117	100	0	27		.0602
114	100	0	9		.1925
112	100	0	-3		.4967
109	100	0	-21		2.0333
106	100	0	-39		2.5832
103	100	0	-57		2.4455
100	100	0	-75		.0583
164	200	0	-51		.0350
166	200	0	-39		.2997
168	200	0	-27		1.8079
170	200	0	-15		.9863
172**	200	0	0		.7415
172**	200	25	0		.6990
172**	200	51	0		.6192
174	200	0	9		.0485
176	200	0	21		.0490
178	200	0	33		.0105
121	200	0	51		.0070
238	400	0	33		.0000
236	400	0	21		.0105
235	400	0	15		.1349
234	400	0	9		.3447
232**	400	0	0		.4220
232**	400	25	0		.2516
232**	400	51	0		.1188
231	400	0	-9		.4014
229	400	0	-21		.6864
227	400	0	-33		.2283
289	800	0	-21		.0469
290	800	0	-15		.1505
291	800	0	-9		.2385
292**	800	0	0		.1743
292**	800	25	0		.1211
292**	800	76	0		.0432
292**	800	127	0		.0203
294	800	0	9		.1132
295	800	0	15		.0189
296	800	0	21		.0047
297	800	0	27		.0000

* POSITIVE ANGLES ARE CLOCKWISE DIRECTION.

** MODEL SAMPLE LOCATION HALFWAY TO NEXT HIGHEST GRID POINT.

CONCENTRATION DATA FOR RUN NO. 20
 STABILITY: SLIGHTLY UNSTABLE
 WIND DIRECTION: 135 DEG.
 RELEASE POINT: A

SAMPLER GRID POINT	PROTOTYPE		MODEL		CONCENTRATION COEFFICIENT
	ARC (M)	ELEV (M)	DEGREES OFF* CENTER LINE		
120	100	0	45		.0047
117	100	0	27		.1115
114	100	0	9		.3977
112**	100	0	0		.6615
109	100	0	-21		1.1619
106	100	0	-39		.7860
103	100	0	-57		.5771
100	100	0	-75		.0307
164	200	0	-51		.0407
166	200	0	-39		.1635
168	200	0	-27		.5169
170	200	0	-15		.8362
172**	200	0	0		.6721
172**	200	25	0		.6692
172**	200	51	0		.3405
174	200	0	9		.2832
176	200	0	21		.1410
178	200	0	33		.0330
121	200	0	51		.0118
239	400	0	39		.0130
237	400	0	27		.0230
235	400	0	15		.1280
234	400	0	9		.3346
232**	400	0	0		.3700
232**	400	25	0		.3210
232**	400	51	0		.1611
231	400	0	-9		.2726
229	400	0	-21		.3245
227	400	0	-33		.2089
289	800	0	-21		.0372
290	800	0	-15		.1033
291	800	0	-9		.1216
292**	800	0	0		.1186
292**	800	25	0		.0938
292**	800	76	0		.0667
292**	800	127	0		.0372
293	800	0	3		.1145
294	800	0	9		.0909
295	800	0	15		.0384
296	800	0	21		.0195

* POSITIVE ANGLES ARE CLOCKWISE DIRECTION.

** MODEL SAMPLE LOCATION HALFWAY TO NEXT HIGHEST GRID POINT.

CONCENTRATION DATA FOR RUN NO. 4
 STABILITY: NEUTRAL
 WIND DIRECTION: 135 DEG.
 RELEASE POINT: G5

SAMPLER GRID POINT	PROTOTYPE		MODEL		CONCENTRATION COEFFICIENT
	ARC (M)	ELEV (M)	DEGREES OFF* CENTER LINE		
120	100	0	45		2.5959
117	100	0	27		2.2314
114	100	0	9		1.6494
112	100	0	-3		1.2829
109	100	0	-21		1.4007
106	100	0	-39		1.1117
103	100	0	-57		.8711
100	100	0	-75		.6021
164	200	0	-51		.0223
166	200	0	-39		.2055
168	200	0	-27		.5106
170	200	0	-15		.7311
172**	200	0	0		.8580
172**	200	25	0		.4210
172**	200	51	0		.1612
174	200	0	9		.8318
176	200	0	21		.4804
178	200	0	33		.6566
121	200	0	51		.5539
238	400	0	33		.0152
236	400	0	21		.3203
235	400	0	15		.2992
234	400	0	9		.3545
232**	400	0	0		.3203
232**	400	25	0		.1964
232**	400	51	0		.0948
231	400	0	-9		.2035
229	400	0	-21		.3022
227	400	0	-33		.0253
289	800	0	-21		.0051
290	800	0	-15		.0615
291	800	0	-9		.1129
292**	800	0	0		.1119
292**	800	25	0		.0847
292**	800	76	0		.0444
292**	800	127	0		.0112
294	800	0	9		.1562
295	800	0	15		.1018
296	800	0	21		.0162
297	800	0	27		.0001

* POSITIVE ANGLES ARE CLOCKWISE DIRECTION.

** MODEL SAMPLE LOCATION HALFWAY TO NEXT HIGHEST GRID POINT.

CONCENTRATION DATA FOR RUN NO. 13
 STABILITY: MODERATELY STABLE
 WIND DIRECTION: 135 DEG.
 RELEASE POINT: G5

SAMPLER GRID POINT	PROTOTYPE ARC (M)	ELEV (M)	MODEL DEGREES OFF* CENTER LINE	CONCENTRATION COEFFICIENT
120	100	0	45	3.5574
117	100	0	27	2.6149
114	100	0	9	2.2923
112	100	0	-3	2.0258
109	100	0	-21	1.9366
106	100	0	-39	1.3975
103	100	0	-57	1.0025
100	100	0	-75	.7181
164	200	0	-51	.1868
166	200	0	-39	.1274
168	200	0	-27	.8539
170	200	0	-15	.7753
172**	200	0	0	.9678
172**	200	25	0	.3349
172**	200	51	0	.1554
174	200	0	9	.4236
176	200	0	21	.3198
178	200	0	33	.5470
121	200	0	51	1.7240
238	400	0	33	.2648
236	400	0	21	.7832
235	400	0	15	.3433
234	400	0	9	.3310
232**	400	0	0	.1992
232**	400	25	0	.0920
232**	400	51	0	.0550
231	400	0	-9	.1459
229	400	0	-21	.3063
227	400	0	-33	.1010
289	800	0	-21	.0236
290	800	0	-15	.0684
291	800	0	-9	.1004
292**	800	0	0	.0898
292**	800	25	0	.0673
292**	800	76	0	.0264
292**	800	127	0	.0090
294	800	0	9	.2362
295	800	0	15	.3490
296	800	0	21	.0135
297	800	0	27	.0000

* POSITIVE ANGLES ARE CLOCKWISE DIRECTION.

** MODEL SAMPLE LOCATION HALFWAY TO NEXT HIGHEST GRID POINT.

CONCENTRATION DATA FOR RUN NO. 20
 STABILITY: SLIGHTLY UNSTABLE
 WIND DIRECTION: 135 DEG.
 RELEASE POINT: G5

SAMPLER GRID POINT	PROTOTYPE		MODEL		CONCENTRATION COEFFICIENT
	ARC (M)	ELEV (M)	DEGREES OFF* CENTER LINE		
120	100	0	45		2.2325
117	100	0	27		1.9227
114	100	0	9		1.5299
112**	100	0	0		1.2755
109	100	0	-21		1.3209
106	100	0	-39		.9922
103	100	0	-57		.7857
100	100	0	-75		.1599
164	200	0	-51		.0541
166	200	0	-39		.1989
168	200	0	-27		.4218
170	200	0	-15		.6548
172**	200	0	0		.7920
172**	200	25	0		.3715
172**	200	51	0		.1184
174	200	0	9		.8625
176	200	0	21		.5427
178	200	0	33		.7920
121	200	0	51		.0567
239	400	0	39		.0164
237	400	0	27		.1801
235	400	0	15		.3324
234	400	0	9		.3412
232**	400	0	0		.3437
232**	400	25	0		.1801
232**	400	51	0		.0995
231	400	0	-9		.1763
229	400	0	-21		.1989
227	400	0	-33		.1549
289	800	0	-21		.0290
290	800	0	-15		.0667
291	800	0	-9		.0869
292**	800	0	0		.0970
292**	800	25	0		.0856
292**	800	76	0		.0604
292**	800	127	0		.0302
293	800	0	3		.1033
294	800	0	9		.1196
295	800	0	15		.0869
296	800	0	21		.0491

* POSITIVE ANGLES ARE CLOCKWISE DIRECTION.

** MODEL SAMPLE LOCATION HALFWAY TO NEXT HIGHEST GRID POINT.

CONCENTRATION DATA FOR RUN NO. 4
 STABILITY: NEUTRAL
 WIND DIRECTION: 135 DEG.
 RELEASE POINT: G17

SAMPLER GRID POINT	PROTOTYPE		MODEL		CONCENTRATION COEFFICIENT
	ARC (M)	ELEV (M)	DEGREES OFF* CENTER LINE		
120	100	0	45		.0205
117	100	0	27		.3530
114	100	0	9		.8982
112	100	0	-3		1.5500
109	100	0	-21		2.2673
106	100	0	-39		2.3141
103	100	0	-57		2.0594
100	100	0	-75		.0054
164	200	0	-51		.0515
166	200	0	-39		.2718
168	200	0	-27		1.0290
170	200	0	-15		1.0758
172**	200	0	0		.8603
172**	200	25	0		.6731
172**	200	51	0		.2952
174	200	0	9		.2580
176	200	0	21		.0088
178	200	0	33		.0233
121	200	0	51		.2057
238	400	0	33		.0074
236	400	0	21		.0191
235	400	0	15		.1602
234	400	0	9		.3847
232**	400	0	0		.4562
232**	400	25	0		.2965
232**	400	51	0		.1472
231	400	0	-9		.3564
229	400	0	-21		.5134
227	400	0	-33		.0487
289	800	0	-21		.0074
290	800	0	-15		.0955
291	800	0	-9		.2002
292**	800	0	0		.1692
292**	800	25	0		.1176
292**	800	76	0		.0618
292**	800	127	0		.0219
294	800	0	9		.1293
295	800	0	15		.0240
296	800	0	21		.0184
297	800	0	27		.0054

* POSITIVE ANGLES ARE CLOCKWISE DIRECTION.

** MODEL SAMPLE LOCATION HALFWAY TO NEXT HIGHEST GRID POINT.

CONCENTRATION DATA FOR RUN NO. 13
 STABILITY: MODERATELY STABLE
 WIND DIRECTION: 135 DEG.
 RELEASE POINT: G17

SAMPLER GRID POINT	PROTOTYPE		MODEL		CONCENTRATION COEFFICIENT
	ARC (M)	ELEV (M)	DEGREES OFF* CENTER LINE		
120	100	0	45		.0222
117	100	0	27		.1030
114	100	0	9		.3781
112	100	0	-3		.9739
109	100	0	-21		3.4642
106	100	0	-39		3.5620
103	100	0	-57		2.7680
100	100	0	-75		.0482
164	200	0	-51		.2764
166	200	0	-39		.1969
168	200	0	-27		1.3560
170	200	0	-15		1.2438
172**	200	0	0		1.0196
172**	200	25	0		.8657
172**	200	51	0		.5567
174	200	0	9		.0639
176	200	0	21		.0548
178	200	0	33		.0000
121	200	0	51		.0000
238	400	0	33		.0000
236	400	0	21		.0065
235	400	0	15		.1617
234	400	0	9		.4446
232**	400	0	0		.3924
232**	400	25	0		.2125
232**	400	51	0		.1043
231	400	0	-9		.3207
229	400	0	-21		.5763
227	400	0	-33		.1891
289	800	0	-21		.0339
290	800	0	-15		.1356
291	800	0	-9		.1956
292**	800	0	0		.1565
292**	800	25	0		.1043
292**	800	76	0		.0326
292**	800	127	0		.0222
294	800	0	9		.1095
295	800	0	15		.0143
296	800	0	21		.0000
297	800	0	27		.0000

* POSITIVE ANGLES ARE CLOCKWISE DIRECTION.

** MODEL SAMPLE LOCATION HALFWAY TO NEXT HIGHEST GRID POINT.

CONCENTRATION DATA FOR RUN NO. 20
 STABILITY: SLIGHTLY UNSTABLE
 WIND DIRECTION: 135 DEG.
 RELEASE POINT: G17

SAMPLER GRID POINT	PROTOTYPE		MODEL		CONCENTRATION COEFFICIENT
	ARC (M)	ELEV (M)	DEGREES OFF* CENTER LINE		
120	100	0	45		.0031
117	100	0	27		.7384
114	100	0	9		1.2525
112**	100	0	0		1.4581
109	100	0	-21		2.1249
106	100	0	-39		1.9535
103	100	0	-57		1.7136
100	100	0	-75		.0810
164	200	0	-51		.1059
166	200	0	-39		.4237
168	200	0	-27		.8599
170	200	0	-15		.9721
172**	200	0	0		.8256
172**	200	25	0		.5515
172**	200	51	0		.2337
174	200	0	9		.4705
176	200	0	21		.2212
178	200	0	33		.1122
121	200	0	51		.0249
239	400	0	39		.0280
237	400	0	27		.0280
235	400	0	15		.1589
234	400	0	9		.3303
232**	400	0	0		.3770
232**	400	25	0		.2617
232**	400	51	0		.1464
231	400	0	-9		.2898
229	400	0	-21		.3739
227	400	0	-33		.2679
289	800	0	-21		.0654
290	800	0	-15		.1215
291	800	0	-9		.1402
292**	800	0	0		.1153
292**	800	25	0		.1090
292**	800	76	0		.0872
292**	800	127	0		.0436
293	800	0	3		.1215
294	800	0	9		.0935
295	800	0	15		.0841
296	800	0	21		.0218

* POSITIVE ANGLES ARE CLOCKWISE DIRECTION.

** MODEL SAMPLE LOCATION HALFWAY TO NEXT HIGHEST GRID POINT.

Table 10. Data, Wind Direction 180°

CONCENTRATION DATA FOR RUN NO. 5
 STABILITY: NEUTRAL
 WIND DIRECTION: 180 DEG.
 RELEASE POINT: C

SAMPLER GRID POINT	PRTOTYPE		MODEL		CONCENTRATION COEFFICIENT
	ARC (M)	ELEV (M)	DEGREES OFF* CENTER LINE		
68	100	0	48		.0167
64	100	0	24		.0641
120	100	0	0		.0463
118	100	0	-12		.0274
116	100	0	-24		.0132
114	100	0	-36		.0120
112	100	0	-48		.0120
108	100	0	-72		.0120
173	200	0	-42		.0120
175	200	0	-30		.0321
177	200	0	-18		.0179
179	200	0	-6		.0203
180	200	0	0		.1091
180	200	25	0		.4161
180	200	51	0		.2952
121	200	0	6		.4113
123	200	0	18		.5843
125	200	0	30		.0226
127	200	0	42		.0120
186	400	0	36		.0132
184	400	0	24		.0132
182	400	0	12		.4682
181	400	0	6		.5073
240	400	25	0		.3935
240	400	51	0		.2146
238	400	0	-12		.0641
236	400	0	-24		.0155
234	400	0	-36		.0132
296	800	0	-24		.0143
298	800	0	-12		.0191
299	800	0	-6		.0878
300	800	0	0		.1909
300	800	25	0		.1577
300	800	76	0		.0831
300	800	127	0		.0321
241	800	0	6		.2679
242	800	0	12		.0688
243	800	0	18		.0132
244	800	0	24		.0143

* POSITIVE ANGLES ARE CLOCKWISE DIRECTION.

** MODEL SAMPLE LOCATION HALFWAY TO NEXT HIGHEST GRID POINT.

CONCENTRATION DATA FOR RUN NO. 14
 STABILITY: MODERATELY STABLE
 WIND DIRECTION: 180 DEG.
 RELEASE POINT: C

SAMPLER GRID POINT	PROTOTYPE		MODEL		CONCENTRATION COEFFICIENT
	ARC (M)	ELEV (M)	DEGREES OFF* CENTER LINE		
68	100	0	48		.0000
64	100	0	24		.0965
120	100	0	0		.0240
118	100	0	-12		.0073
116	100	0	-24		.0000
114	100	0	-36		.0000
112	100	0	-48		.0000
108	100	0	-72		.0000
173	200	0	-42		.0000
175	200	0	-30		.0000
177	200	0	-18		.0000
179	200	0	-6		.0000
180	200	0	0		.0379
180	200	25	0		.0547
180	200	51	0		.0000
121	200	0	6		.2388
123	200	0	18		1.3940
125	200	0	30		.0379
127	200	0	42		.0000
186	400	0	36		.0000
184	400	0	24		.0073
182	400	0	12		1.2461
181	400	0	6		1.0424
240	400	0	0		.7327
240	400	25	0		.4286
240	400	51	0		.0128
238	400	0	-12		.0017
236	400	0	-24		.0000
234	400	0	-36		.0000
296	800	0	-24		.0000
298	800	0	-12		.0017
299	800	0	-6		.0379
300	800	0	0		.3700
300	800	25	0		.2333
300	800	76	0		.0463
300	800	127	0		.0045
241	800	0	6		.7522
242	800	0	12		.2277
243	800	0	18		.0100
244	800	0	24		.0000

* POSITIVE ANGLES ARE CLOCKWISE DIRECTION.

** MODEL SAMPLE LOCATION HALFWAY TO NEXT HIGHEST GRID POINT.

CONCENTRATION DATA FOR RUN NO. 21
 STABILITY: SLIGHTLY UNSTABLE
 WIND DIRECTION: 180 DEG.
 RELEASE POINT: C

SAMPLER GRID POINT	PROTOTYPE ARC (M)	ELEV (M)	MODEL DEGREES OFF* CENTER LINE	CONCENTRATION COEFFICIENT
68	100	0	48	.0104
64	100	0	24	.0801
120	100	0	0	.0801
118	100	0	-12	.0162
116	100	0	-24	.0000
114	100	0	-36	.0000
112	100	0	-48	.0000
108	100	0	-72	.0000
173	200	0	-42	.0000
175	200	0	-30	.0000
177	200	0	-18	.0000
179	200	0	-6	.0395
180	200	0	0	.0917
180	200	25	0	.6256
180	200	51	0	.3586
121	200	0	6	.4515
123	200	0	18	.5792
125	200	0	30	.0046
127	200	0	42	.0000
187	400	0	42	.0000
185	400	0	30	.0000
183	400	0	18	.1149
181	400	0	6	.4631
240	400	0	0	.3354
240	400	25	0	.3354
240	400	51	0	.1439
239	400	0	-6	.2426
237	400	0	-18	.0569
235	400	0	-30	.0046
297	800	0	-18	.0046
298	800	0	-12	.0104
299	800	0	-6	.0569
300	800	0	0	.1265
300	800	25	0	.0975
300	800	76	0	.0743
300	800	127	0	.0337
241	800	0	6	.1671
242	800	0	12	.0975
243	800	0	18	.0395
244	800	0	24	.0000

* POSITIVE ANGLES ARE CLOCKWISE DIRECTION.

** MODEL SAMPLE LOCATION HALFWAY TO NEXT HIGHEST GRID POINT.

CONCENTRATION DATA FOR RUN NO. 5

STABILITY: NEUTRAL

WIND DIRECTION: 180 DEG.

RELEASE POINT: A

SAMPLER GRID POINT	PROTOTYPE		MODEL		CONCENTRATION COEFFICIENT
	ARC (M)	ELEV (M)	DEGREES OFF* CENTER LINE		
68	100	0	48		.3475
64	100	0	24		1.8691
120	100	0	0		.6810
118	100	0	-12		.1068
116	100	0	-24		.1299
114	100	0	-36		.0454
112	100	0	-48		.0151
108	100	0	-72		.0104
173	200	0	-42		.0125
175	200	0	-30		.0509
177	200	0	-18		.0633
179	200	0	-6		.1363
180	200	0	0		.3369
180	200	25	0		.2660
180	200	51	0		.1223
121	200	0	6		.4797
123	200	0	18		.7854
125	200	0	30		.1830
127	200	0	42		.0221
186	400	0	36		.0185
184	400	0	24		.0452
182	400	0	12		.5710
181	400	0	6		.3379
240	400	25	0		.2785
240	400	51	0		.1885
238	400	0	-12		.0821
236	400	0	-24		.0142
234	400	0	-36		.0142
296	800	0	-24		.0140
298	800	0	-12		.0204
299	800	0	-6		.0696
300	800	0	0		.1469
300	800	25	0		.1280
300	800	76	0		.0832
300	800	127	0		.0340
241	800	0	6		.2254
242	800	0	12		.1204
243	800	0	18		.0202
244	800	0	24		.0161

* POSITIVE ANGLES ARE CLOCKWISE DIRECTION.

** MODEL SAMPLE LOCATION HALFWAY TO NEXT HIGHEST GRID POINT.

CONCENTRATION DATA FOR RUN NO. 14
 STABILITY: MODERATELY STABLE
 WIND DIRECTION: 180 DEG.
 RELEASE POINT: A

SAMPLER GRID POINT	PROTOTYPE		MODEL		CONCENTRATION COEFFICIENT
	ARC (M)	ELEV (M)	DEGREES OFF* CENTER LINE		
68	100	0	48		3.3193
64	100	0	24		3.3103
120	100	0	0		.1365
118	100	0	-12		.0335
116	100	0	-24		.0268
114	100	0	-36		.0584
112	100	0	-48		.0222
108	100	0	-72		.0089
173	200	0	-42		.0055
175	200	0	-30		.0118
177	200	0	-18		.0178
179	200	0	-6		.0164
180	200	0	0		.0306
180	200	25	0		.0171
180	200	51	0		.0058
123	200	0	18		.6808
125	200	0	30		2.6153
127	200	0	42		.2142
186	400	0	36		.0239
184	400	0	24		.9452
182	400	0	12		.8099
181	400	0	6		.2964
240	400	0	0		.1958
240	400	25	0		.0866
240	400	51	0		.0123
238	400	0	-12		.0140
236	400	0	-24		.0000
234	400	0	-36		.0000
296	800	0	-24		.0000
298	800	0	-12		.0116
299	800	0	-6		.0169
300	800	0	0		.1117
300	800	25	0		.0822
300	800	76	0		.0203
300	800	127	0		.0048
241	800	0	6		.5559
242	800	0	12		.7631
243	800	0	18		.3651
244	800	0	24		.0463

* POSITIVE ANGLES ARE CLOCKWISE DIRECTION.

** MODEL SAMPLE LOCATION HALFWAY TO NEXT HIGHEST GRID POINT.

CONCENTRATION DATA FOR RUN NO. 21
 STABILITY: SLIGHTLY UNSTABLE
 WIND DIRECTION: 160 DEG.
 RELEASE POINT: A

SAMPLER GRID POINT	PROTOTYPE		MODEL		CONCENTRATION COEFFICIENT
	ARC (M)	ELEV (M)	DEGREES OFF* CENTER LINE		
68	100	0	48		.4266
64	100	0	24		2.1792
120	100	0	0		.3464
118	100	0	-12		.1357
116	100	0	-24		.1363
114	100	0	-36		.0820
112	100	0	-48		.0307
108	100	0	-72		.0130
173	200	0	-42		.0077
175	200	0	-30		.0212
177	200	0	-18		.0407
179	200	0	-6		.1204
180	200	0	0		.1782
180	200	25	0		.2797
180	200	51	0		.2467
121	200	0	6		.3293
123	200	0	18		.7541
125	200	0	30		.3369
127	200	0	42		.0165
187	400	0	42		.0077
185	400	0	30		.0083
183	400	0	18		.2685
181	400	0	6		.3080
240	400	0	0		.2166
240	400	25	0		.2490
240	400	51	0		.1511
239	400	0	-6		.1505
237	400	0	-18		.0549
235	400	0	-30		.0195
297	800	0	-18		.0124
298	800	0	-12		.0283
299	800	0	-6		.0655
300	800	0	0		.1174
300	800	25	0		.0944
300	800	76	0		.0838
300	800	127	0		.0425
241	800	0	6		.1699
242	800	0	12		.1056
243	800	0	18		.0207
244	800	0	24		.0083

* POSITIVE ANGLES ARE CLOCKWISE DIRECTION.

** MODEL SAMPLE LOCATION HALFWAY TO NEXT HIGHEST GRID POINT.

CONCENTRATION DATA FOR RUN NO. 5

STABILITY: NEUTRAL
 WIND DIRECTION: 180 DEG.
 RELEASE POINT: G5

SAMPLER GRID POINT	PROTOTYPE		MODEL		CONCENTRATION COEFFICIENT
	ARC (M)	ELEV (M)	DEGREES OFF* CENTER LINE		
68	100	0	48		.4389
64	100	0	24		2.7891
120	100	0	0		.0524
118	100	0	-12		.0565
116	100	0	-24		.0073
114	100	0	-36		.0060
112	100	0	-48		.0066
108	100	0	-72		.0053
173	200	0	-42		.0053
175	200	0	-30		.0496
177	200	0	-18		.0087
179	200	0	-6		.0129
180	200	0	0		.0489
180	200	25	0		.1105
180	200	51	0		.0898
121	200	0	6		.1611
123	200	0	18		.9092
125	200	0	30		.2068
127	200	0	42		.0094
186	400	0	36		.0080
184	400	0	24		.0323
182	400	0	12		.6300
181	400	0	6		.2290
240	400	25	0		.2588
240	400	51	0		.1805
238	400	0	-12		.0399
236	400	0	-24		.0080
234	400	0	-36		.0073
296	800	0	-24		.0094
298	800	0	-12		.0094
299	800	0	-6		.0447
300	800	0	0		.1196
300	800	25	0		.1071
300	800	76	0		.0655
300	800	127	0		.0240
241	800	0	6		.2006
242	800	0	12		.1168
243	800	0	18		.0108
244	800	0	24		.0087

* POSITIVE ANGLES ARE CLOCKWISE DIRECTION.

** MODEL SAMPLE LOCATION HALFWAY TO NEXT HIGHEST GRID POINT.

CONCENTRATION DATA FOR RUN NO. 14
 STABILITY: MODERATELY STABLE
 WIND DIRECTION: 180 DEG.
 RELEASE POINT: G5

SAMPLER GRID POINT	PROTOTYPE		MODEL		CONCENTRATION COEFFICIENT
	ARC (M)	ELEV (M)	DEGREES OFF* CENTER LINE		
68	100	0	48		3.1900
64	100	0	24		3.2310
120	100	0	0		.1564
118	100	0	-12		.0211
116	100	0	-24		.0094
114	100	0	-36		.0200
112	100	0	-48		.0089
108	100	0	-72		.0061
173	200	0	-42		.0022
175	200	0	-30		.0050
177	200	0	-18		.0089
179	200	0	-6		.0055
180	200	0	0		.0405
180	200	25	0		.0172
180	200	51	0		.0022
123	200	0	18		1.0125
125	200	0	30		2.4376
127	200	0	42		.3305
186	400	0	36		.0238
184	400	0	24		.9487
182	400	0	12		1.0131
181	400	0	6		.4458
240	400	0	0		.2800
240	400	25	0		.1153
240	400	51	0		.0072
238	400	0	-12		.0067
236	400	0	-24		.0022
234	400	0	-36		.0017
296	800	0	-24		.0022
298	800	0	-12		.0050
299	800	0	-6		.0183
300	800	0	0		.1597
300	800	25	0		.1148
300	800	76	0		.0250
300	800	127	0		.0100
241	800	0	6		.7253
242	800	0	12		.8290
243	800	0	18		.3726
244	800	0	24		.0455

* POSITIVE ANGLES ARE CLOCKWISE DIRECTION.

** MODEL SAMPLE LOCATION HALFWAY TO NEXT HIGHEST GRID POINT.

CONCENTRATION DATA FOR RUN NO. 21
 STABILITY: SLIGHTLY UNSTABLE
 WIND DIRECTION: 180 DEG.
 RELEASE POINT: G5

SAMPLER GRID POINT	PROTOTYPE		MODEL		CONCENTRATION COEFFICIENT
	ARC (M)	ELEV (M)	DEGREES OFF* CENTER LINE		
68	100	0	48		.6346
64	100	0	24		5.0618
120	100	0	0		.0768
118	100	0	-12		.0189
116	100	0	-24		.0403
114	100	0	-36		.0101
112	100	0	-48		.0088
108	100	0	-72		.0063
173	200	0	-42		.0063
175	200	0	-30		.0050
177	200	0	-18		.0139
179	200	0	-6		.0164
180	200	0	0		.0302
180	200	25	0		.2481
180	200	51	0		.1725
121	200	0	6		.1763
123	200	0	18		1.5500
125	200	0	30		.5276
127	200	0	42		.0189
187	400	0	42		.0063
185	400	0	30		.0088
183	400	0	18		.4407
181	400	0	6		.3526
240	400	0	0		.2115
240	400	25	0		.2821
240	400	51	0		.1977
239	400	0	-6		.1184
237	400	0	-18		.0327
235	400	0	-30		.0164
297	800	0	-18		.0101
298	800	0	-12		.0239
299	800	0	-6		.0667
300	800	0	0		.1310
300	800	25	0		.1146
300	800	76	0		.0944
300	800	127	0		.0491
241	800	0	6		.1952
242	800	0	12		.1448
243	800	0	18		.0302
244	800	0	24		.0025

* POSITIVE ANGLES ARE CLOCKWISE DIRECTION.

** MODEL SAMPLE LOCATION HALFWAY TO NEXT HIGHEST GRID POINT.

CONCENTRATION DATA FOR RUN NO. 5
 STABILITY: NEUTRAL
 WIND DIRECTION: 180 DEG.
 RELEASE POINT: G17

SAMPLER GRID POINT	PROTOTYPE		MODEL		CONCENTRATION COEFFICIENT
	ARC (M)	ELEV (M)	DEGREES OFF* CENTER LINE		
68	100	0	48		.0440
64	100	0	24		2.3553
120	100	0	0		.1235
118	100	0	-12		.0368
116	100	0	-24		.0060
114	100	0	-36		.0043
112	100	0	-48		.0032
108	100	0	-72		.0015
173	200	0	-42		.0026
175	200	0	-30		.0329
177	200	0	-18		.0099
179	200	0	-6		.0200
180	200	0	0		.1022
180	200	25	0		.1912
180	200	51	0		.1403
121	200	0	6		.2511
123	200	0	18		.6708
125	200	0	30		.0737
127	200	0	42		.0043
186	400	0	36		.0037
184	400	0	24		.0121
182	400	0	12		.4783
181	400	0	6		.3339
240	400	25	0		.3502
240	400	51	0		.2589
238	400	0	-12		.0536
236	400	0	-24		.0032
234	400	0	-36		.0054
296	800	0	-24		.0037
298	800	0	-12		.0082
299	800	0	-6		.0659
300	800	0	0		.1733
300	800	25	0		.1487
300	800	76	0		.0899
300	800	127	0		.0289
241	800	0	6		.2623
242	800	0	12		.0860
243	800	0	18		.0043
244	800	0	24		.0054

* POSITIVE ANGLES ARE CLOCKWISE DIRECTION.

** MODEL SAMPLE LOCATION HALFWAY TO NEXT HIGHEST GRID POINT.

CONCENTRATION DATA FOR RUN NO. 14

STABILITY: MODERATELY STABLE

WIND DIRECTION: 180 DEG.

RELEASE POINT: G17

SAMPLER GRID POINT	PROTOTYPE ARC (M)	ELEV (M)	MODEL DEGREES OFF* CENTER LINE	CONCENTRATION COEFFICIENT
68	100	0	48	.1233
64	100	0	24	2.8786
120	100	0	0	.1383
118	100	0	-12	.0249
116	100	0	-24	.0075
114	100	0	-36	.0224
112	100	0	-48	.0062
108	100	0	-72	.0000
173	200	0	-42	.0000
175	200	0	-30	.0037
177	200	0	-18	.0062
179	200	0	-6	.0050
180	200	0	0	.0573
180	200	25	0	.0274
180	200	51	0	.0012
121	200	0	6	.0187
123	200	0	18	.8732
125	200	0	30	.7038
127	200	0	42	.0162
186	400	0	36	.0000
184	400	0	24	.1644
182	400	0	12	.8919
181	400	0	6	.5294
240	400	0	0	.3600
240	400	25	0	.1731
240	400	51	0	.0087
238	400	0	-12	.0062
236	400	0	-24	.0037
234	400	0	-36	.0000
296	800	0	-24	.0087
298	800	0	-12	.0037
299	800	0	-6	.0237
300	800	0	0	.2005
300	800	25	0	.1383
300	800	76	0	.0336
300	800	127	0	.0062
241	800	0	6	.6714
242	800	0	12	.4210
243	800	0	18	.0735
244	800	0	24	.0062

* POSITIVE ANGLES ARE CLOCKWISE DIRECTION.

** MODEL SAMPLE LOCATION HALFWAY TO NEXT HIGHEST GRID POINT.

CONCENTRATION DATA FOR RUN NO. 21
 STABILITY: SLIGHTLY UNSTABLE
 WIND DIRECTION: 180 DEG.
 RELEASE POINT: G17

SAMPLER GRID POINT	PROTOTYPE		MODEL		CONCENTRATION COEFFICIENT
	ARC (M)	ELEV (M)	DEGREES OFF* CENTER LINE		
68	100	0	48		.0499
64	100	0	24		1.5547
120	100	0	0		.1122
118	100	0	-12		.0218
116	100	0	-24		.0280
114	100	0	-36		.0062
112	100	0	-48		.0093
108	100	0	-72		.0000
173	200	0	-42		.0125
175	200	0	-30		.0125
177	200	0	-18		.0249
179	200	0	-6		.0249
180	200	0	0		.0499
180	200	25	0		.3053
180	200	51	0		.3147
121	200	0	6		.1932
123	200	0	18		.5203
125	200	0	30		.1215
127	200	0	42		.0093
187	400	0	42		.0093
185	400	0	30		.0093
183	400	0	18		.1496
181	400	0	6		.3053
240	400	0	0		.2150
240	400	25	0		.2804
240	400	51	0		.1901
239	400	0	-6		.1527
237	400	0	-18		.0436
235	400	0	-30		.0218
297	800	0	-18		.0218
298	800	0	-12		.0280
299	800	0	-6		.0654
300	800	0	0		.1277
300	800	25	0		.1153
300	800	76	0		.0997
300	800	127	0		.0499
241	800	0	6		.1714
242	800	0	12		.0966
243	800	0	18		.0623
244	800	0	24		.0031

* POSITIVE ANGLES ARE CLOCKWISE DIRECTION.

** MODEL SAMPLE LOCATION HALFWAY TO NEXT HIGHEST GRID POINT.

Table 11. Data, Wind Direction 225^o

CONCENTRATION DATA FOR RUN NO. 6
 STABILITY: NEUTRAL
 WIND DIRECTION: 225 DEG.
 RELEASE POINT: C

SAMPLER GRID POINT	PROTOTYPE		MODEL		CONCENTRATION COEFFICIENT
	ARC (M)	ELEV (M)	DEGREES OFF* CENTER LINE		
73	100	0	33		.0345
71	100	0	21		.1435
69	100	0	9		.3710
67**	100	0	0		.1968
65	100	0	-15		.0594
63	100	0	-27		.0108
120	100	0	-45		.0060
117	100	0	-63		.0072
179	200	0	-51		.0060
122	200	0	-33		.0250
124	200	0	-21		.0369
126	200	0	-9		.3118
127**	200	0	0		.7253
127**	200	25	0		1.3072
127**	200	51	0		.6922
129	200	0	9		.5511
131	200	0	21		.1364
133	200	0	33		.0072
135	200	0	45		.0072
193	400	0	33		.0084
191	400	0	21		.0096
189	400	0	9		.1992
188	400	0	3		.5725
187**	400	0	0		.6211
187**	400	25	0		.5511
187**	400	51	0		.1068
185	400	0	-15		.0890
182	400	0	-33		.0084
244	800	0	-21		.0072
246	800	0	-9		.0795
247	800	0	-3		.3378
247**	800	0	0		.3438
247**	800	25	0		.2478
247**	800	76	0		.0973
247**	800	127	0		.0262
248	800	0	3		.2454
249	800	0	9		.0226
250	800	0	15		.0108
251	800	0	21		.0037

* POSITIVE ANGLES ARE CLOCKWISE DIRECTION.

** MODEL SAMPLE LOCATION HALFWAY TO NEXT HIGHEST GRID POINT.

CONCENTRATION DATA FOR RUN NO. 15
 STABILITY: MODERATELY STABLE
 WIND DIRECTION: 225 DEG.
 RELEASE POINT: C

SAMPLER GRID POINT	PROTOTYPE		MODEL		CONCENTRATION COEFFICIENT
	ARC (M)	ELEV (M)	DEGREES OFF* CENTER LINE		
73	100	0	33		.0128
61	100	0	21		.3002
69	100	0	9		.7522
67**	100	0	0		.4035
65	100	0	-15		.0128
63	100	0	-27		.0000
120	100	0	-45		.0000
117	100	0	-63		.0463
179	200	0	-51		.0000
122	200	0	-33		.0000
124	200	0	-21		.0073
126	200	0	-9		.4425
127**	200	0	0		1.3968
127**	200	25	0		1.9018
127**	200	51	0		.3449
129	200	0	9		1.1122
131	200	0	21		.1496
133	200	0	33		.0017
135	200	0	45		.0000
193	400	0	33		.0000
191	400	0	21		.0000
189	400	0	9		.7160
188	400	0	3		1.4358
187**	400	0	0		1.4665
187**	400	25	0		.8387
187**	400	51	0		.2444
185	400	0	-15		.0073
184	400	0	-21		.0000
182	400	0	-33		.0000
244	800	0	-21		.0000
246	800	0	-9		.0854
247	800	0	-3		.4062
247**	800	0	0		.8052
247**	800	25	0		.4676
247**	800	76	0		.0073
247**	800	127	0		.0296
248	800	0	3		.7299
249	800	0	9		.0686
250	800	0	15		.0017
251	800	0	21		.0000

* POSITIVE ANGLES ARE CLOCKWISE DIRECTION.

** MODEL SAMPLE LOCATION HALFWAY TO NEXT HIGHEST GRID POINT.

CONCENTRATION DATA FOR RUN NO. 22
 STABILITY: SLIGHTLY UNSTABLE
 WIND DIRECTION: 225 DEG.
 RELEASE POINT: C

SAMPLER GRID POINT	PROTOTYPE		MODEL		CONCENTRATION COEFFICIENT
	ARC (M)	ELEV (M)	DEGREES OFF* CENTER LINE		
73	100	0	33		.0000
71	100	0	21		.1091
69	100	0	9		.4225
67**	100	0	0		.6256
65	100	0	-15		.0453
63	100	0	-27		.0000
120	100	0	-45		.0000
117	100	0	-63		.0000
179	200	0	-51		.0000
122	200	0	-33		.0000
124	200	0	-21		.0000
126	200	0	-9		.3993
127**	200	0	0		.9390
127**	200	25	0		.8809
127**	200	51	0		.4225
129	200	0	9		.7242
133	200	0	33		.0000
135	200	0	45		.0000
194	400	0	39		.0000
192	400	0	27		.0000
190	400	0	15		.0511
189	400	0	9		.2774
187**	400	0	0		.4457
187**	400	25	0		.3819
187**	400	51	0		.1903
186	400	0	-9		.3296
184	400	0	-21		.0395
182	400	0	-33		.0000
244	800	0	-21		.0000
245	800	0	-15		.0279
246	800	0	-9		.1091
247**	800	0	0		.1439
247**	800	25	0		.1033
247**	800	76	0		.0743
247**	800	127	0		.0000
248	800	0	3		.1439
249	800	0	9		.1207
250	800	0	15		.0569
251	800	0	21		.0000

* POSITIVE ANGLES ARE CLOCKWISE DIRECTION.

** MODEL SAMPLE LOCATION HALFWAY TO NEXT HIGHEST GRID POINT.

CONCENTRATION DATA FOR RUN NO. 6
 STABILITY: NEUTRAL
 WIND DIRECTION: 225 DEG.
 RELEASE POINT: A

SAMPLER GRID POINT	PROTOTYPE		MODEL		CONCENTRATION COEFFICIENT
	ARC (M)	ELEV (M)	DEGREES OFF* CENTER LINE		
73	100	0	33		2.3008
71	100	0	21		2.7778
69	100	0	9		2.3547
67**	100	0	0		.6481
65	100	0	-15		.1713
63	100	0	-27		.0335
120	100	0	-45		.0104
117	100	0	-63		.0921
179	200	0	-51		.0089
122	200	0	-33		.0673
124	200	0	-21		.0384
126	200	0	-9		.3031
127**	200	0	0		1.3564
127**	200	25	0		.8771
127**	200	51	0		.3101
129	200	0	9		1.5209
131	200	0	21		1.4122
133	200	0	33		.0270
135	200	0	45		.0166
193	400	0	33		.0206
191	400	0	21		.0469
189	400	0	9		.6054
188	400	0	3		.7920
187**	400	0	0		.7028
187**	400	25	0		.4466
187**	400	51	0		.1199
185	400	0	-15		.1127
182	400	0	-33		.0163
244	800	0	-21		.0151
246	800	0	-9		.0645
247	800	0	-3		.2891
247**	800	0	0		.3798
247**	800	25	0		.2505
247**	800	76	0		.1000
247**	800	127	0		.0280
248	800	0	3		.3539
249	800	0	9		.0643
250	800	0	15		.0136
251	800	0	21		.0093

* POSITIVE ANGLES ARE CLOCKWISE DIRECTION.

** MODEL SAMPLE LOCATION HALFWAY TO NEXT HIGHEST GRID POINT.

CONCENTRATION DATA FOR RUN NO. 15

STABILITY: MODERATELY STABLE

WIND DIRECTION: 225 DEG.

RELEASE POINT: A

SAMPLER GRID POINT	PROTOTYPE		MODEL		CONCENTRATION COEFFICIENT
	ARC (M)	ELEV (M)	DEGREES OFF* CENTER LINE		
73	100	0	33		2.6165
71	100	0	21		3.2768
69	100	0	9		3.0291
67**	100	0	0		1.9776
65	100	0	-15		.2192
63	100	0	-27		.0473
120	100	0	-45		.0236
117	100	0	-63		.0152
179	200	0	-51		.0154
122	200	0	-33		.0171
124	200	0	-21		.0695
126	200	0	-9		.8914
127**	200	0	0		1.6149
127**	200	25	0		1.1048
129	200	0	9		2.1440
131	200	0	21		1.5628
133	200	0	33		.1206
135	200	0	45		.0253
193	400	0	33		.0193
191	400	0	21		.0921
189	400	0	9		1.1485
188	400	0	3		1.2977
187**	400	0	0		1.2534
187**	400	25	0		.5014
187**	400	51	0		.1751
185	400	0	-15		.0417
184	400	0	-21		.0147
182	400	0	-33		.0130
244	800	0	-21		.0154
246	800	0	-9		.1194
247	800	0	-3		.3437
247**	800	0	0		.6408
247**	800	25	0		.3791
247**	800	76	0		.0241
247**	800	127	0		.0400
248	800	0	3		.7004
249	800	0	9		.1968
250	800	0	15		.0359
251	800	0	21		.0176

* POSITIVE ANGLES ARE CLOCKWISE DIRECTION.

** MODEL SAMPLE LOCATION HALFWAY TO NEXT HIGHEST GRID POINT.

CONCENTRATION DATA FOR RUN NO. 22
 STABILITY: SLIGHTLY UNSTABLE
 WIND DIRECTION: 225 DEG.
 RELEASE POINT: A

SAMPLER GRID POINT	PROTOTYPE ARC (M)	ELEV (M)	MODEL DEGREES OFF* CENTER LINE	CONCENTRATION COEFFICIENT
73	100	0	33	1.8417
71	100	0	21	3.8615
69	100	0	9	4.7508
67**	100	0	0	1.5602
65	100	0	-15	.1133
63	100	0	-27	.0378
120	100	0	-45	.0159
117	100	0	-63	.0153
179	200	0	-51	.0124
122	200	0	-33	.0159
124	200	0	-21	.0443
126	200	0	-9	.2077
127**	200	0	0	.5877
127**	200	25	0	.4856
127**	200	51	0	.2213
129	200	0	9	1.4628
133	200	0	33	.0732
135	200	0	45	.0207
194	400	0	39	.0130
192	400	0	27	.0248
190	400	0	15	.2762
189	400	0	9	.5824
187**	400	0	0	.4815
187**	400	25	0	.3257
187**	400	51	0	.1823
186	400	0	-9	.2089
184	400	0	-21	.0460
182	400	0	-33	.0148
244	800	0	-21	.0130
245	800	0	-15	.0189
246	800	0	-9	.1009
247**	800	0	0	.1823
247**	800	25	0	.1310
247**	800	76	0	.0944
247**	800	127	0	.0437
248	800	0	3	.2077
249	800	0	9	.1794
250	800	0	15	.0643
251	800	0	21	.0136

* POSITIVE ANGLES ARE CLOCKWISE DIRECTION.

** MODEL SAMPLE LOCATION HALFWAY TO NEXT HIGHEST GRID POINT.

CONCENTRATION DATA FOR RUN NO. 6

STABILITY: NEUTRAL

WIND DIRECTION: 225 DEG.

RELEASE POINT: G5

SAMPLER GRID POINT	PROTOTYPE		MODEL		CONCENTRATION COEFFICIENT
	ARC (M)	ELEV (M)	DEGREES OFF* CENTER LINE		
73	100	0	33		2.1207
71	100	0	21		2.4656
69	100	0	9		2.0833
67**	100	0	0		.4465
65	100	0	-15		.1175
63	100	0	-27		.0163
120	100	0	-45		.0025
117	100	0	-63		.0025
179	200	0	-51		.0018
122	200	0	-33		.0447
124	200	0	-21		.0233
126	200	0	-9		.2255
127**	200	0	0		1.0221
127**	200	25	0		.6765
127**	200	51	0		.2463
129	200	0	9		1.1094
131	200	0	21		1.0789
133	200	0	33		.0087
135	200	0	45		.0025
193	400	0	33		.0046
191	400	0	21		.0233
189	400	0	9		.4624
188	400	0	3		.6210
187**	400	0	0		.5476
187**	400	25	0		.3447
187**	400	51	0		.0704
185	400	0	-15		.0690
182	400	0	-33		.0046
244	800	0	-21		.0053
246	800	0	-9		.0420
247	800	0	-3		.2221
247**	800	0	0		.2865
247**	800	25	0		.1923
247**	800	76	0		.0676
247**	800	127	0		.0129
248	800	0	3		.2685
249	800	0	9		.0420
250	800	0	15		.0094
251	800	0	21		.0136

* POSITIVE ANGLES ARE CLOCKWISE DIRECTION.

** MODEL SAMPLE LOCATION HALFWAY TO NEXT HIGHEST GRID POINT.

CONCENTRATION DATA FOR RUN NO. 15
 STABILITY: MODERATELY STABLE
 WIND DIRECTION: 225 DEG.
 RELEASE POINT: G5

SAMPLER GRID POINT	PROTOTYPE		MODEL		CONCENTRATION COEFFICIENT
	ARC (M)	ELEV (M)	DEGREES OFF* CENTER LINE		
73	100	0	33		2.1836
71	100	0	21		3.1090
69	100	0	9		2.9959
67**	100	0	0		2.3045
65	100	0	-15		.2756
63	100	0	-27		.0233
120	100	0	-45		.0139
117	100	0	-65		.0072
179	200	0	-51		.0067
122	200	0	-33		.0333
124	200	0	-21		.0843
126	200	0	-9		1.3535
127**	200	0	0		2.1337
127**	200	25	0		1.6541
127**	200	51	0		.0033
129	200	0	9		2.3089
131	200	0	21		1.2293
133	200	0	33		.0665
135	200	0	45		.0116
193	400	0	33		.0061
191	400	0	21		.0510
189	400	0	9		1.2798
188	400	0	3		1.7017
187**	400	0	0		1.6258
187**	400	25	0		.7497
187**	400	51	0		.2307
185	400	0	-15		.0316
184	400	0	-21		.0072
182	400	0	-33		.0033
244	800	0	-21		.0061
246	800	0	-9		.1553
247	800	0	-3		.4680
247**	800	0	0		.8672
247**	800	25	0		.5063
247**	800	76	0		.0161
247**	800	127	0		.0366
248	800	0	3		.8944
249	800	0	9		.1741
250	800	0	15		.0172
251	800	0	21		.0061

* POSITIVE ANGLES ARE CLOCKWISE DIRECTION.

** MODEL SAMPLE LOCATION HALFWAY TO NEXT HIGHEST GRID POINT.

CONCENTRATION DATA FOR RUN NO. 22
 STABILITY: SLIGHTLY UNSTABLE
 WIND DIRECTION: 225 DEG.
 RELEASE POINT: G5

SAMPLER GRID POINT	PROTOTYPE		MODEL	
	ARC (M)	ELEV (M)	DEGREES OFF* CENTER LINE	CONCENTRATION COEFFICIENT
73	100	0	33	2.3521
71	100	0	21	3.8581
69	100	0	9	4.2635
67**	100	0	0	1.5185
65	100	0	-15	.1524
65	100	0	-27	.0290
120	100	0	-45	.0126
117	100	0	-63	.0176
179	200	0	-51	.0113
122	200	0	-33	.0113
124	200	0	-21	.0516
126	200	0	-9	.3160
127**	200	0	0	.7353
127**	200	25	0	.6384
127**	200	51	0	.2896
129	200	0	9	1.5437
133	200	0	33	.1033
135	200	0	45	.0189
194	400	0	39	.0113
192	400	0	27	.0239
190	400	0	15	.3236
189	400	0	9	.6132
187**	400	0	0	.5754
187**	400	25	0	.3954
187**	400	51	0	.2115
186	400	0	-9	.2619
184	400	0	-21	.0642
182	400	0	-33	.0101
244	800	0	-21	.0139
245	800	0	-15	.0214
246	800	0	-9	.1247
247**	800	0	0	.2229
247**	800	25	0	.1561
247**	800	76	0	.1033
247**	800	127	0	.0579
248	800	0	3	.2392
249	800	0	9	.2166
250	800	0	15	.0730
251	800	0	21	.0151

* POSITIVE ANGLES ARE CLOCKWISE DIRECTION.

** MODEL SAMPLE LOCATION HALFWAY TO NEXT HIGHEST GRID POINT.

CONCENTRATION DATA FOR RUN NO. 6
 STABILITY: NEUTRAL
 WIND DIRECTION: 225 DEG.
 RELEASE POINT: G17

SAMPLER GRID POINT	PROTOTYPE		MODEL		CONCENTRATION COEFFICIENT
	ARC (M)	ELEV (M)	DEGREES OFF* CENTER LINE		
73	100	0	33		.1358
71	100	0	21		.4084
69	100	0	9		2.0598
67**	100	0	0		1.6625
65	100	0	-15		1.3944
63	100	0	-27		.1890
120	100	0	-45		.0010
117	100	0	-63		.0000
179	200	0	-51		.0000
122	200	0	-33		.0368
124	200	0	-21		.1548
126	200	0	-9		.8242
127**	200	0	0		1.0195
127**	200	25	0		.8723
127**	200	51	0		.4151
129	200	0	9		.4654
131	200	0	21		.2259
133	200	0	33		.0000
135	200	0	45		.0000
193	400	0	33		.0000
191	400	0	21		.0043
189	400	0	9		.1851
188	400	0	3		.4917
187**	400	0	0		.5169
187**	400	25	0		.4324
187**	400	51	0		.0905
185	400	0	-15		.1386
182	400	0	-33		.0037
244	800	0	-21		.0000
246	800	0	-9		.0894
247	800	0	-3		.2948
247**	800	0	0		.2880
247**	800	25	0		.2075
247**	800	76	0		.0771
247**	800	127	0		.0138
248	800	0	3		.2086
249	800	0	9		.0144
250	800	0	15		.0015
251	800	0	21		.0000

* POSITIVE ANGLES ARE CLOCKWISE DIRECTION.

** MODEL SAMPLE LOCATION HALFWAY TO NEXT HIGHEST GRID POINT.

CONCENTRATION DATA FOR RUN NO. 15
 STABILITY: MODERATELY STABLE
 WIND DIRECTION: 225 DEG.
 RELEASE POINT: G17

SAMPLER GRID POINT	PROTOTYPE		MODEL		CONCENTRATION COEFFICIENT
	ARC (M)	ELEV (M)	DEGREES OFF* CENTER LINE		
73	100	0	33		.2043
71	100	0	21		.8894
69	100	0	9		2.1487
67**	100	0	0		3.8763
65	100	0	-15		.7798
63	100	0	-27		.0224
120	100	0	-45		.0062
117	100	0	-63		.0037
179	200	0	-51		.0037
122	200	0	-33		.0075
124	200	0	-21		.1034
126	200	0	-9		1.4013
127**	200	0	0		1.9095
127**	200	25	0		1.4897
127**	200	51	0		.2753
129	200	0	9		1.1671
131	200	0	21		.3513
133	200	0	33		.0149
135	200	0	45		.0037
193	400	0	33		.0037
191	400	0	21		.0112
189	400	0	9		.6365
188	400	0	3		1.0202
187**	400	0	0		1.1360
187**	400	25	0		.6228
187**	400	51	0		.2142
185	400	0	-15		.0349
184	400	0	-21		.0075
182	400	0	-33		.0037
244	800	0	-21		.0361
246	800	0	-9		.1607
247	800	0	-3		.4260
247**	800	0	0		.6415
247**	800	25	0		.3986
247**	800	76	0		.0125
247**	800	127	0		.0336
248	800	0	3		.5618
249	800	0	9		.0735
250	800	0	15		.0100
251	800	0	21		.0037

* POSITIVE ANGLES ARE CLOCKWISE DIRECTION.

** MODEL SAMPLE LOCATION HALFWAY TO NEXT HIGHEST GRID POINT.

CONCENTRATION DATA FOR RUN NO. 22
 STABILITY: SLIGHTLY UNSTABLE
 WIND DIRECTION: 225 DEG.
 RELEASE POINT: G17

SAMPLER GRID POINT	PROTOTYPE		MODEL	
	ARC (M)	ELEV (M)	DEGREES OFF* CENTER LINE	CONCENTRATION COEFFICIENT
73	100	0	33	.1464
71	100	0	21	.4580
69	100	0	9	1.1590
67**	100	0	0	2.0750
65	100	0	-15	.6294
63	100	0	-27	.1028
120	100	0	-45	.0093
117	100	0	-63	.0156
179	200	0	-51	.0156
122	200	0	-33	.0093
124	200	0	-21	.1371
126	200	0	-9	.5608
127**	200	0	0	.9721
127**	200	25	0	.7633
127**	200	51	0	.3676
129	200	0	9	.8412
133	200	0	33	.0093
135	200	0	45	.0093
194	400	0	39	.0125
192	400	0	27	.0125
190	400	0	15	.1184
189	400	0	9	.3209
187**	400	0	0	.4860
187**	400	25	0	.4050
187**	400	51	0	.2150
186	400	0	-9	.3365
184	400	0	-21	.1090
182	400	0	-33	.0218
244	800	0	-21	.0249
245	800	0	-15	.0405
246	800	0	-9	.1433
247**	800	0	0	.1932
247**	800	25	0	.1433
247**	800	76	0	.1059
247**	800	127	0	.0467
248	800	0	3	.2056
249	800	0	9	.1620
250	800	0	15	.0966
251	800	0	21	.0125

* POSITIVE ANGLES ARE CLOCKWISE DIRECTION.

** MODEL SAMPLE LOCATION HALFWAY TO NEXT HIGHEST GRID POINT.

Table 12. Data, Wind Direction 270^o

CONCENTRATION DATA FOR RUN NO. 7

STABILITY: NEUTRAL

WIND DIRECTION: 270 DEG.

RELEASE POINT: C

SAMPLER GRID POINT	PROTOTYPE		MODEL		CONCENTRATION COEFFICIENT
	ARC (M)	ELEV (M)	DEGREES OFF* CENTER LINE		
84	100	0	54		.0048
81	100	0	36		.0242
79	100	0	24		.0616
77	100	0	12		.0653
75	100	0	0		1.1616
73	100	0	-12		.5874
71	100	0	-24		.1668
69	100	0	-36		.0423
66	100	0	-54		.0073
128	200	0	-42		.0411
130	200	0	-30		.0060
132	200	0	-18		.1680
134	200	0	-6		1.1664
135	200	0	0		1.0794
135	200	25	0		1.0540
135	200	51	0		.6539
136	200	0	6		.4992
138	200	0	18		.0508
140	200	0	30		.0073
200	400	0	30		.0073
198	400	0	18		.0097
196	400	0	6		.3457
195	400	0	0		.6612
195	400	25	0		.4883
195	400	51	0		.3300
194	400	0	-6		.5258
193	400	0	-12		.0604
192	400	0	-18		.0242
190	400	0	-30		.0133
252	800	0	-18		.0181
253	800	0	-12		.0169
254	800	0	-6		.1934
255	800	0	0		.3409
255	800	25	0		.2321
255	800	76	0		.0967
255	800	127	0		.0338
256	800	0	6		.1076
257	800	0	12		.0169
258	800	0	18		.0121
259	800	0	24		.0073

* POSITIVE ANGLES ARE CLOCKWISE DIRECTION.

** MODEL SAMPLE LOCATION HALFWAY TO NEXT HIGHEST GRID POINT.

CONCENTRATION DATA FOR RUN NO. 16
 STABILITY: MODERATELY STABLE
 WIND DIRECTION: 270 DEG.
 RELEASE POINT: C

SAMPLER GRID POINT	PROTOTYPE		MODEL		CONCENTRATION COEFFICIENT
	ARC (M)	ELEV (M)	DEGREES OFF* CENTER LINE		
84	100	0	54		.0009
81	100	0	36		.0124
79	100	0	24		.1447
77	100	0	12		.0958
75	100	0	0		1.1606
73	100	0	-12		.7174
71	100	0	-24		.1994
69	100	0	-36		.0354
66	100	0	-54		.0066
128	200	0	-42		.0037
130	200	0	-30		.0066
132	200	0	-18		.0757
134	200	0	-6		.9505
135	200	0	0		1.4023
135	200	25	0		1.7706
135	200	51	0		1.0253
136	200	0	6		1.4224
138	200	0	18		.1390
140	200	0	30		.0066
200	400	0	30		.0009
198	400	0	18		.0066
196	400	0	6		.9419
195	400	0	0		.9188
195	400	25	0		.7145
195	400	51	0		.3807
194	400	0	-6		.4095
193	400	0	-12		.0239
192	400	0	-18		.0066
190	400	0	-30		.0181
252	800	0	-18		.0009
253	800	0	-12		.0009
254	800	0	-6		.2426
255	800	0	0		.5476
255	800	25	0		.2570
255	800	76	0		.0325
255	800	127	0		.0066
256	800	0	6		.4210
257	800	0	12		.0095
258	800	0	18		.0000
259	800	0	24		.0037

* POSITIVE ANGLES ARE CLOCKWISE DIRECTION.

** MODEL SAMPLE LOCATION HALFWAY TO NEXT HIGHEST GRID POINT.

CONCENTRATION DATA FOR RUN NO. 23

STABILITY: SLIGHTLY UNSTABLE

WIND DIRECTION: 270 DEG.

RELEASE POINT: C

SAMPLER GRID POINT	PROTOTYPE		MODEL		CONCENTRATION COEFFICIENT
	ARC (M)	ELEV (M)	DEGREES OFF* CENTER LINE		
84	100	0	54		.0000
81	100	0	36		.0000
77	100	0	12		.5966
75	100	0	0		1.5425
73	100	0	-12		.5501
71	100	0	-24		.0453
69	100	0	-36		.0000
66	100	0	-54		.0000
129	200	0	-36		.0000
131	200	0	-24		.0000
133	200	0	-12		.5908
135	200	0	0		1.0492
135	200	25	0		1.0260
135	200	51	0		.5327
136	200	0	6		.8809
138	200	0	18		.2136
140	200	0	30		.0000
142	200	0	42		.0000
144	200	0	54		.0000
200	400	0	30		.0000
198	400	0	18		.0221
197	400	0	12		.2948
195	400	0	0		.3819
195	400	25	0		.3528
195	400	51	0		.1091
194	400	0	-6		.3122
192	400	0	-18		.1033
190	400	0	-30		.0000
252	800	0	-18		.0000
253	800	0	-12		.0000
254	800	0	-6		.0453
255	800	0	0		.1265
255	800	25	0		.0801
255	800	76	0		.0162
255	800	127	0		.0000
256	800	0	6		.1149
257	800	0	12		.0453
258	800	0	18		.0000
259	800	0	24		.0000

* POSITIVE ANGLES ARE CLOCKWISE DIRECTION.

** MODEL SAMPLE LOCATION HALFWAY TO NEXT HIGHEST GRID POINT.

CONCENTRATION DATA FOR RUN NO. 7
 STABILITY: NEUTRAL
 WIND DIRECTION: 270 DEG.
 RELEASE POINT: A

SAMPLER GRID POINT	PROTOTYPE		MODEL		CONCENTRATION COEFFICIENT
	ARC (M)	ELEV (M)	DEGREES OFF* CENTER LINE		
84	100	0	54		.0100
81	100	0	36		.0792
79	100	0	24		1.0252
77	100	0	12		.2810
75	100	0	0		2.0574
73	100	0	-12		.6775
71	100	0	-24		.0002
69	100	0	-36		.1187
66	100	0	-54		.0130
128	200	0	-42		.0747
130	200	0	-30		.0169
132	200	0	-18		.1455
134	200	0	-6		1.1363
135	200	0	0		1.2638
135	200	25	0		.7433
135	200	51	0		.3492
136	200	0	6		1.5353
138	200	0	18		.3837
140	200	0	30		.0758
200	400	0	30		.0210
198	400	0	18		.0303
196	400	0	6		.6288
195	400	0	0		.6937
195	400	25	0		.4333
195	400	51	0		.2678
194	400	0	-6		.3915
193	400	0	-12		.0786
192	400	0	-18		.0325
190	400	0	-30		.0223
252	800	0	-18		.0225
253	800	0	-12		.0227
254	800	0	-6		.1399
255	800	0	0		.3412
255	800	25	0		.2241
255	800	76	0		.1070
255	800	127	0		.0394
256	800	0	6		.1814
257	800	0	12		.0230
258	800	0	18		.0191
259	800	0	24		.0145

* POSITIVE ANGLES ARE CLOCKWISE DIRECTION.

** MODEL SAMPLE LOCATION HALFWAY TO NEXT HIGHEST GRID POINT.

CONCENTRATION DATA FOR RUN NO. 16

STABILITY: MODERATELY STABLE

WIND DIRECTION: 270 DEG.

RELEASE POINT: A

SAMPLER GRID POINT	PROTOTYPE		MODEL	
	ARC (M)	ELEV (M)	DEGREES OFF* CENTER LINE	CONCENTRATION COEFFICIENT
84	100	0	54	.0935
81	100	0	36	.5626
79	100	0	24	3.1244
77	100	0	12	1.1825
75	100	0	0	2.5829
73	100	0	-12	1.0895
71	100	0	-24	.5664
69	100	0	-36	.1122
66	100	0	-54	.0107
128	200	0	-42	.0149
130	200	0	-30	.0239
132	200	0	-18	.1597
134	200	0	-6	1.1499
135	200	0	0	1.7322
135	200	25	0	1.1126
135	200	51	0	.4159
136	200	0	6	2.2444
138	200	0	18	1.8747
140	200	0	30	.5430
200	400	0	30	.0027
198	400	0	18	.2793
196	400	0	6	1.2230
195	400	0	0	.7206
195	400	25	0	.4373
195	400	51	0	.2209
194	400	0	-6	.4102
193	400	0	-12	.0567
192	400	0	-18	.0142
190	400	0	-30	.0000
252	800	0	-18	.0000
253	800	0	-12	.0075
254	800	0	-6	.2343
255	800	0	0	.4313
255	800	25	0	.2025
255	800	76	0	.0313
255	800	127	0	.0000
256	800	0	6	.5313
257	800	0	12	.0510
258	800	0	18	.0037
259	800	0	24	.0000

* POSITIVE ANGLES ARE CLOCKWISE DIRECTION.

** MODEL SAMPLE LOCATION HALFWAY TO NEXT HIGHEST GRID POINT.

CONCENTRATION DATA FOR RUN NO. 23
 STABILITY: SLIGHTLY UNSTABLE
 WIND DIRECTION: 270 DEG.
 RELEASE POINT: A

SAMPLER GRID POINT	PROTOTYPE		MODEL		CONCENTRATION COEFFICIENT
	ARC (M)	ELEV (M)	DEGREES OFF* CENTER LINE		
84	100	0	54		.0159
81	100	0	36		.4331
77	100	0	12		3.0047
75	100	0	0		2.5197
73	100	0	-12		.6585
71	100	0	-24		.2726
69	100	0	-36		.0679
66	100	0	-54		.0177
129	200	0	-36		.0153
131	200	0	-24		.0454
133	200	0	-12		.5529
135	200	0	0		1.0468
135	200	25	0		.7293
135	200	51	0		.3824
136	200	0	6		1.2439
138	200	0	18		.8137
140	200	0	30		.0738
142	200	0	42		.0165
144	200	0	54		.0106
200	400	0	30		.0089
198	400	0	18		.1699
197	400	0	12		.4585
195	400	0	0		.4378
195	400	25	0		.3830
195	400	51	0		.1670
194	400	0	-6		.2927
192	400	0	-18		.1357
190	400	0	-30		.0118
252	800	0	-18		.0100
253	800	0	-12		.0212
254	800	0	-6		.0938
255	800	0	0		.1758
255	800	25	0		.1310
255	800	76	0		.0679
255	800	127	0		.0484
256	800	0	6		.1841
257	800	0	12		.1416
258	800	0	18		.0189
259	800	0	24		.0100

* POSITIVE ANGLES ARE CLOCKWISE DIRECTION.

** MODEL SAMPLE LOCATION HALFWAY TO NEXT HIGHEST GRID POINT.

CONCENTRATION DATA FOR RUN NO. 7

STABILITY: NEUTRAL

WIND DIRECTION: 270 DEG.

RELEASE POINT: G5

SAMPLER GRID POINT	PROTOTYPE		MODEL		CONCENTRATION COEFFICIENT
	ARC (M)	ELEV (M)	DEGREES OFF* CENTER LINE		
84	100	0	54		.0093
81	100	0	36		.0894
79	100	0	24		.1072
77	100	0	12		.1704
75	100	0	0		2.3366
73	100	0	-12		2.9448
71	100	0	-24		2.8500
69	100	0	-36		2.5810
66	100	0	-54		.7077
128	200	0	-42		.1087
130	200	0	-30		.1418
132	200	0	-18		1.0045
134	200	0	-6		1.1301
135	200	0	0		.9559
135	200	25	0		.7092
135	200	51	0		.3662
136	200	0	6		.3616
138	200	0	18		.0439
140	200	0	30		.0139
200	400	0	30		.0139
198	400	0	18		.0146
196	400	0	6		.2143
195	400	0	0		.5381
195	400	25	0		.3608
195	400	51	0		.2297
194	400	0	-6		.5836
193	400	0	-12		.1449
192	400	0	-18		.1072
190	400	0	-30		.0200
252	800	0	-18		.0216
253	800	0	-12		.0347
254	800	0	-6		.2536
255	800	0	0		.2775
255	800	25	0		.2027
255	800	76	0		.0933
255	800	127	0		.0416
256	800	0	6		.0817
257	800	0	12		.0231
258	800	0	18		.0170
259	800	0	24		.0108

* POSITIVE ANGLES ARE CLOCKWISE DIRECTION.

** MODEL SAMPLE LOCATION HALFWAY TO NEXT HIGHEST GRID POINT.

CONCENTRATION DATA FOR RUN NO. 16

STABILITY: MODERATELY STABLE

WIND DIRECTION: 270 DEG.

RELEASE POINT: G5

SAMPLER GRID POINT	PROTOTYPE		MODEL		CONCENTRATION COEFFICIENT
	ARC (M)	ELEV (M)	DEGREES OFF* CENTER LINE		
84	100	0	54		.0201
81	100	0	36		.2237
79	100	0	24		1.4350
77	100	0	12		.5869
75	100	0	0		2.4815
73	100	0	-12		2.8127
71	100	0	-24		2.4804
69	100	0	-36		.6755
66	100	0	-54		.0201
128	200	0	-42		.0081
130	200	0	-30		.0527
132	200	0	-18		.5383
134	200	0	-6		1.7152
135	200	0	0		1.6163
135	200	25	0		1.4247
135	200	51	0		.7567
136	200	0	6		1.7558
138	200	0	18		.6321
140	200	0	30		.0773
200	400	0	30		.0024
198	400	0	18		.0579
196	400	0	6		1.0364
195	400	0	0		.9803
195	400	25	0		.6972
195	400	51	0		.3701
194	400	0	-6		.6772
193	400	0	-12		.0922
192	400	0	-18		.0270
190	400	0	-30		.0000
252	800	0	-18		.0000
253	800	0	-12		.0024
254	800	0	-6		.3553
255	800	0	0		.5588
255	800	25	0		.2895
255	800	76	0		.0379
255	800	127	0		.0041
256	800	0	6		.4754
257	800	0	12		.0127
258	800	0	18		.0000
259	800	0	24		.0000

* POSITIVE ANGLES ARE CLOCKWISE DIRECTION.

** MODEL SAMPLE LOCATION HALFWAY TO NEXT HIGHEST GRID POINT.

CONCENTRATION DATA FOR RUN NO. 23
 STABILITY: SLIGHTLY UNSTABLE
 WIND DIRECTION: 270 DEG.
 RELEASE POINT: G5

SAMPLER GRID POINT	PROTOTYPE		MODEL		CONCENTRATION COEFFICIENT
	ARC (M)	ELEV (M)	DEGREES OFF* CENTER LINE		
84	100	0	54		.0189
81	100	0	36		.4143
77	100	0	12		2.9477
75	100	0	0		3.1844
73	100	0	-12		1.8648
71	100	0	-24		.8273
69	100	0	-36		.1826
66	100	0	-54		.0126
129	200	0	-36		.0076
131	200	0	-24		.0831
133	200	0	-12		1.0590
135	200	0	0		1.5500
135	200	25	0		1.1144
135	200	51	0		.5956
136	200	0	6		1.5387
138	200	0	18		.8373
140	200	0	30		.0579
142	200	0	42		.0101
144	200	0	54		.0113
200	400	0	30		.0076
198	400	0	18		.1700
197	400	0	12		.5654
195	400	0	0		.6220
195	400	25	0		.5830
195	400	51	0		.2027
194	400	0	-6		.4659
192	400	0	-18		.2304
190	400	0	-30		.0164
252	800	0	-18		.0126
253	800	0	-12		.0315
254	800	0	-6		.1335
255	800	0	0		.2606
255	800	25	0		.1864
255	800	76	0		.1247
255	800	127	0		.0592
256	800	0	6		.2543
257	800	0	12		.1712
258	800	0	18		.0227
259	800	0	24		.0126

* POSITIVE ANGLES ARE CLOCKWISE DIRECTION.

** MODEL SAMPLE LOCATION HALFWAY TO NEXT HIGHEST GRID POINT.

CONCENTRATION DATA FOR RUN NO. 7
 STABILITY: NEUTRAL
 WIND DIRECTION: 270 DEG.
 RELEASE POINT: G17

SAMPLER GRID POINT	PROTOTYPE		MODEL		CONCENTRATION COEFFICIENT
	ARC (M)	ELEV (M)	DEGREES OFF* CENTER LINE		
84	100	0	54		.0040
81	100	0	36		.0653
79	100	0	24		.9886
77	100	0	12		.2495
75	100	0	0		2.5771
73	100	0	-12		1.6189
71	100	0	-24		.8183
69	100	0	-36		.3531
66	100	0	-54		.0119
128	200	0	-42		.0851
130	200	0	-30		.0172
132	200	0	-18		.3234
134	200	0	-6		1.5364
135	200	0	0		1.7291
135	200	25	0		1.1140
135	200	51	0		.5973
136	200	0	6		1.7053
138	200	0	18		.3419
140	200	0	30		.0422
200	400	0	30		.0125
198	400	0	18		.0198
196	400	0	6		.7596
195	400	0	0		.9873
195	400	25	0		.6501
195	400	51	0		.4065
194	400	0	-6		.6322
193	400	0	-12		.1016
192	400	0	-18		.0350
190	400	0	-30		.0092
252	800	0	-18		.0198
253	800	0	-12		.0205
254	800	0	-6		.2323
255	800	0	0		.4969
255	800	25	0		.3300
255	800	76	0		.1373
255	800	127	0		.0449
256	800	0	6		.2033
257	800	0	12		.0224
258	800	0	18		.0145
259	800	0	24		.0112

* POSITIVE ANGLES ARE CLOCKWISE DIRECTION.

** MODEL SAMPLE LOCATION HALFWAY TO NEXT HIGHEST GRID POINT.

CONCENTRATION DATA FOR RUN NO. 16

STABILITY: MODERATELY STABLE

WIND DIRECTION: 270 DEG.

RELEASE POINT: G17

SAMPLER GRID POINT	PROTOTYPE		MODEL		CONCENTRATION COEFFICIENT
	ARC (M)	ELEV (M)	DEGREES OFF* CENTER LINE		
84	100	0	54		.0005
81	100	0	36		.0442
79	100	0	24		.0853
77	100	0	12		.1572
75	100	0	0		2.0573
73	100	0	-12		4.3248
71	100	0	-24		4.1269
69	100	0	-36		2.9424
66	100	0	-54		.9306
128	200	0	-42		.0352
130	200	0	-30		.2536
132	200	0	-18		1.2582
134	200	0	-6		1.9404
135	200	0	0		1.0796
135	200	25	0		.8600
135	200	51	0		.5067
136	200	0	6		.5568
138	200	0	18		.0699
140	200	0	30		.0018
200	400	0	30		.0000
198	400	0	18		.0005
196	400	0	6		.4142
195	400	0	0		.8869
195	400	25	0		.6416
195	400	51	0		.2819
194	400	0	-6		.7264
193	400	0	-12		.1855
192	400	0	-18		.0969
190	400	0	-30		.0000
252	800	0	-18		.0069
253	800	0	-12		.0095
254	800	0	-6		.4039
255	800	0	0		.3705
255	800	25	0		.2240
255	800	76	0		.0391
255	800	127	0		.0031
256	800	0	6		.1714
257	800	0	12		.0108
258	800	0	18		.0000
259	800	0	24		.0000

* POSITIVE ANGLES ARE CLOCKWISE DIRECTION.

** MODEL SAMPLE LOCATION HALFWAY TO NEXT HIGHEST GRID POINT.

CONCENTRATION DATA FOR RUN NO. 23
 STABILITY: SLIGHTLY UNSTABLE
 WIND DIRECTION: 270 DEG.
 RELEASE POINT: G17

SAMPLER GRID POINT	PROTOTYPE		MODEL		CONCENTRATION COEFFICIENT
	ARC (M)	ELEV (M)	DEGREES OFF* CENTER LINE		
84	100	0	54		.0125
81	100	0	36		.0872
77	100	0	12		.8132
75	100	0	0		2.5361
73	100	0	-12		3.2527
71	100	0	-24		2.1685
69	100	0	-36		1.1528
66	100	0	-54		.1433
129	200	0	-36		.0187
131	200	0	-24		.2866
133	200	0	-12		1.3335
135	200	0	0		1.0780
135	200	25	0		.8007
135	200	51	0		.4518
136	200	0	6		.6979
138	200	0	18		.1963
140	200	0	30		.0187
142	200	0	42		.0062
144	200	0	54		.0093
200	400	0	30		.0031
198	400	0	18		.0530
197	400	0	12		.2430
195	400	0	0		.3832
195	400	25	0		.3708
195	400	51	0		.1433
194	400	0	-6		.4300
192	400	0	-18		.3084
190	400	0	-30		.0249
252	800	0	-18		.0187
253	800	0	-12		.0343
254	800	0	-6		.1122
255	800	0	0		.1682
255	800	25	0		.1246
255	800	76	0		.0717
255	800	127	0		.0436
256	800	0	6		.1464
257	800	0	12		.0779
258	800	0	18		.0187
259	800	0	24		.0125

* POSITIVE ANGLES ARE CLOCKWISE DIRECTION.

** MODEL SAMPLE LOCATION HALFWAY TO NEXT HIGHEST GRID POINT.

Table 13. Data, Wind Direction 315^o

CONCENTRATION DATA FOR RUN NO. 8

STABILITY: NEUTRAL

WIND DIRECTION: 315 DEG.

RELEASE POINT: C

SAMPLER GRID POINT	PROTOTYPE		MODEL		CONCENTRATION COEFFICIENT
	ARC (M)	ELEV (M)	DEGREES OFF* CENTER LINE		
90	100	0	45		.0822
87	100	0	27		.4436
84	100	0	9		1.2002
82**	100	0	0		.8207
81	100	0	-9		.9029
78	100	0	-27		.1789
75	100	0	-45		.0326
72	100	0	-63		.0145
133	200	0	-57		.0133
136	200	0	-39		.0520
138	200	0	-27		.0810
140	200	0	-15		.5149
142**	200	0	0		.9380
142**	200	25	0		.7240
142**	200	51	0		.4279
145	200	0	15		.6986
147	200	0	27		.1039
149	200	0	39		.0218
151	200	0	51		.0145
208	400	0	33		.0157
206	400	0	21		.0568
204	400	0	9		.4629
202**	400	0	0		.4738
202**	400	25	0		.3191
202**	400	51	0		.1994
201	400	0	-9		.2744
199	400	0	-21		.0556
197	400	0	-33		.0205
195	400	0	-45		.0145
259	800	0	-21		.0193
260	800	0	-15		.0363
261	800	0	-9		.1136
262**	800	0	0		.1934
262**	800	25	0		.1475
262**	800	76	0		.0616
262**	800	127	0		.0351
263	800	0	3		.2127
264	800	0	9		.1716
265	800	0	15		.0326
266	800	0	21		.0157

* POSITIVE ANGLES ARE CLOCKWISE DIRECTION.

** MODEL SAMPLE LOCATION HALFWAY TO NEXT HIGHEST GRID POINT.

CONCENTRATION DATA FOR RUN NO. 9
 STABILITY: MODERATELY STABLE
 WIND DIRECTION: 315 DEG.
 RELEASE POINT: C

SAMPLER GRID POINT	PROTOTYPE		MODEL		CONCENTRATION COEFFICIENT
	ARC (M)	ELEV (M)	DEGREES OFF* CENTER LINE		
90	100	0	45		.1655
87	100	0	27		.7740
84	100	0	9		2.3345
82**	100	0	0		1.2828
81	100	0	-9		.9917
78	100	0	-27		.1498
75	100	0	-45		.0134
72	100	0	-63		.0000
133	200	0	-57		.0108
136	200	0	-39		.0000
138	200	0	-27		.0396
140	200	0	-15		.2940
142**	200	0	0		1.3772
142**	200	25	0		.9785
142**	200	51	0		.5589
145	200	0	15		1.6342
147	200	0	27		.1943
149	200	0	39		.0055
151	200	0	51		.0003
208	400	0	33		.0160
206	400	0	21		.0344
204	400	0	9		.9261
202**	400	0	0		.7714
202**	400	25	0		.5904
202**	400	51	0		.3360
201	400	0	-9		.1655
199	400	0	-21		.0029
197	400	0	-33		.0029
195	400	0	-45		.0000
259	800	0	-21		.0003
260	800	0	-15		.0029
261	800	0	-9		.0029
262**	800	0	0		.1366
262**	800	25	0		.2075
262**	800	76	0		.0894
262**	800	127	0		.0160
263	800	0	3		.3937
264	800	0	9		.0737
265	800	0	15		.0055
266	800	0	21		.0003

* POSITIVE ANGLES ARE CLOCKWISE DIRECTION.

** MODEL SAMPLE LOCATION HALFWAY TO NEXT HIGHEST GRID POINT.

CONCENTRATION DATA FOR RUN NO. 24
 STABILITY: SLIGHTLY UNSTABLE
 WIND DIRECTION: 315 DEG.
 RELEASE POINT: C

SAMPLER GRID POINT	PROTOTYPE		MODEL		CONCENTRATION COEFFICIENT
	ARC (M)	ELEV (M)	DEGREES OFF* CENTER LINE		
90	100	0	45		.0870
87	100	0	27		.4526
84	100	0	9		1.2303
82**	100	0	0		1.0678
81	100	0	-9		.9517
78	100	0	-27		.0987
75	100	0	-45		.0870
72	100	0	-63		.0174
133	200	0	-57		.0174
136	200	0	-39		.0116
138	200	0	-27		.2031
140	200	0	-15		.6442
142**	200	0	0		.7428
142**	200	25	0		.5803
142**	200	51	0		.6035
145	200	0	15		.5281
147	200	0	27		.2205
149	200	0	39		.0406
151	200	0	51		.0116
209	400	0	39		.0116
207	400	0	27		.0290
205	400	0	15		.2147
204	400	0	9		.2844
202**	400	0	0		.3018
202**	400	25	0		.2321
202**	400	51	0		.1683
201	400	0	-9		.2611
199	400	0	-21		.2379
197	400	0	-33		.0638
259	800	0	-21		.0348
260	800	0	-15		.0638
261	800	0	-9		.1045
262**	800	0	0		.1335
262**	800	25	0		.1103
262**	800	76	0		.0696
262**	800	127	0		.0464
263	800	0	3		.1277
264	800	0	9		.1277
265	800	0	15		.0580
266	800	0	21		.0232

* POSITIVE ANGLES ARE CLOCKWISE DIRECTION.

** MODEL SAMPLE LOCATION HALFWAY TO NEXT HIGHEST GRID POINT.

CONCENTRATION DATA FOR RUN NO. 8
 STABILITY: NEUTRAL
 WIND DIRECTION: 315 DEG.
 RELEASE POINT: A

SAMPLER GRID POINT	PROTOTYPE		MODEL		CONCENTRATION COEFFICIENT
	ARC (M)	ELEV (M)	DEGREES OFF* CENTER LINE		
90	100	0	45		1.0856
87	100	0	27		1.8315
84	100	0	9		1.4097
82**	100	0	0		.3492
81	100	0	-9		.2382
78	100	0	-27		.0740
75	100	0	-45		.0193
72	100	0	-63		.0100
133	200	0	-57		.0145
136	200	0	-39		.0678
138	200	0	-27		.0338
140	200	0	-15		.1234
142**	200	0	0		.4473
142**	200	25	0		.4623
142**	200	51	0		.3421
145	200	0	15		.9213
147	200	0	27		.5409
149	200	0	39		.0634
151	200	0	51		.0199
208	400	0	33		.0208
206	400	0	21		.1674
204	400	0	9		.5264
202**	400	0	0		.3393
202**	400	25	0		.2522
202**	400	51	0		.1905
201	400	0	-9		.1410
199	400	0	-21		.0474
197	400	0	-33		.0160
195	400	0	-45		.0158
259	800	0	-21		.0152
260	800	0	-15		.0277
261	800	0	-9		.0580
262**	800	0	0		.1535
262**	800	25	0		.1269
262**	800	76	0		.0561
262**	800	127	0		.0323
263	800	0	3		.1856
264	800	0	9		.2380
265	800	0	15		.0699
266	800	0	21		.0162

* POSITIVE ANGLES ARE CLOCKWISE DIRECTION.

** MODEL SAMPLE LOCATION HALFWAY TO NEXT HIGHEST GRID POINT.

CONCENTRATION DATA FOR RUN NO. 9
 STABILITY: MODERATELY STABLE
 WIND DIRECTION: 315 DEG.
 RELEASE POINT: A

SAMPLER GRID POINT	PROTOTYPE		MODEL		CONCENTRATION COEFFICIENT
	ARC (M)	ELEV (M)	DEGREES OFF* CENTER LINE		
90	100	0	45		1.9943
87	100	0	27		2.6242
84	100	0	9		1.6319
82**	100	0	0		.3878
81	100	0	-9		.4864
78	100	0	-27		.1946
75	100	0	-45		.0189
72	100	0	-63		.0007
133	200	0	-57		.0000
136	200	0	-39		.0029
138	200	0	-27		.0162
140	200	0	-15		.1103
142**	200	0	0		.4737
142**	200	25	0		.5155
142**	200	51	0		.3859
145	200	0	15		1.1837
147	200	0	27		1.0745
149	200	0	39		.1017
151	200	0	51		.0093
208	400	0	33		.0019
206	400	0	21		.1347
204	400	0	9		1.0908
202**	400	0	0		.3608
202**	400	25	0		.3508
202**	400	51	0		.3054
201	400	0	-9		.0714
199	400	0	-21		.0053
197	400	0	-33		.0000
195	400	0	-45		.0000
259	800	0	-21		.0000
260	800	0	-15		.0000
261	800	0	-9		.0000
262**	800	0	0		.0654
262**	800	25	0		.1132
262**	800	76	0		.0621
262**	800	127	0		.0122
263	800	0	3		.2538
264	800	0	9		.1218
265	800	0	15		.0000
266	800	0	21		.0000

* POSITIVE ANGLES ARE CLOCKWISE DIRECTION.

** MODEL SAMPLE LOCATION HALFWAY TO NEXT HIGHEST GRID POINT.

CONCENTRATION DATA FOR RUN NO. 24
 STABILITY: SLIGHTLY UNSTABLE
 WIND DIRECTION: 315 DEG.
 RELEASE POINT: A

SAMPLER GRID POINT	PROTOTYPE		MODEL		CONCENTRATION COEFFICIENT
	ARC (M)	ELEV (M)	DEGREES OFF* CENTER LINE		
90	100	0	45		.9140
87	100	0	27		1.8629
84	100	0	9		1.2598
82**	100	0	0		.3145
81	100	0	-9		.2384
78	100	0	-27		.0266
75	100	0	-45		.0195
72	100	0	-63		.0106
133	200	0	-57		.0106
136	200	0	-39		.0118
138	200	0	-27		.0472
140	200	0	-15		.1334
142**	200	0	0		.3564
142**	200	25	0		.4443
142**	200	51	0		.4095
145	200	0	15		.7636
147	200	0	27		.6833
149	200	0	39		.1800
151	200	0	51		.0242
209	400	0	39		.0142
207	400	0	27		.0856
205	400	0	15		.3476
204	400	0	9		.3181
202**	400	0	0		.2213
202**	400	25	0		.1965
202**	400	51	0		.1404
201	400	0	-9		.1239
199	400	0	-21		.0950
197	400	0	-33		.0165
259	800	0	-21		.0153
260	800	0	-15		.0277
261	800	0	-9		.0690
262**	800	0	0		.1080
262**	800	25	0		.0879
262**	800	76	0		.0525
262**	800	127	0		.0354
263	800	0	3		.1098
264	800	0	9		.1298
265	800	0	15		.0820
266	800	0	21		.0348

* POSITIVE ANGLES ARE CLOCKWISE DIRECTION.

** MODEL SAMPLE LOCATION HALFWAY TO NEXT HIGHEST GRID POINT.

CONCENTRATION DATA FOR RUN NO. 8
 STABILITY: NEUTRAL
 WIND DIRECTION: 315 DEG.
 RELEASE POINT: G5

SAMPLER GRID POINT	PROTOTYPE ARC (M)	ELEV (M)	MODEL DEGREES OFF* CENTER LINE	CONCENTRATION COEFFICIENT
90	100	0	45	.3531
87	100	0	27	.8788
84	100	0	9	1.4424
82**	100	0	0	1.3691
81	100	0	-9	1.5819
78	100	0	-27	1.5418
75	100	0	-45	1.2250
72	100	0	-63	.2621
133	200	0	-57	.0177
136	200	0	-39	.1041
138	200	0	-27	.3847
140	200	0	-15	.6082
142**	200	0	0	.7817
142**	200	25	0	.5180
142**	200	51	0	.2829
145	200	0	15	.6892
147	200	0	27	.2320
149	200	0	39	.0378
151	200	0	51	.0146
208	400	0	33	.0185
206	400	0	21	.0863
204	400	0	9	.4032
202**	400	0	0	.4040
202**	400	25	0	.2744
202**	400	51	0	.1735
201	400	0	-9	.2436
199	400	0	-21	.0933
197	400	0	-33	.0270
195	400	0	-45	.0146
259	800	0	-21	.0239
260	800	0	-15	.0493
261	800	0	-9	.1233
262**	800	0	0	.1765
262**	800	25	0	.1380
262**	800	76	0	.0609
262**	800	127	0	.0324
263	800	0	3	.1896
264	800	0	9	.1719
265	800	0	15	.0447
266	800	0	21	.0154

* POSITIVE ANGLES ARE CLOCKWISE DIRECTION.

** MODEL SAMPLE LOCATION HALFWAY TO NEXT HIGHEST GRID POINT.

CONCENTRATION DATA FOR RUN NO. 9

STABILITY: MODERATELY STABLE

WIND DIRECTION: 315 DEG.

RELEASE POINT: G5

SAMPLER GRID POINT	PROTOTYPE		MODEL		CONCENTRATION COEFFICIENT
	ARC (M)	ELEV (M)	DEGREES OFF* CENTER LINE		
90	100	0	45		.6415
87	100	0	27		1.8167
84	100	0	9		2.3710
82**	100	0	0		1.9185
81	100	0	-9		1.6736
78	100	0	-27		1.4512
75	100	0	-45		.0550
72	100	0	-63		.0138
133	200	0	-57		.0133
136	200	0	-39		.0009
138	200	0	-27		.0917
140	200	0	-15		.3709
142**	200	0	0		1.1027
142**	200	25	0		.6254
142**	200	51	0		.3558
145	200	0	15		1.4466
147	200	0	27		.4961
149	200	0	39		.0981
151	200	0	51		.0156
208	400	0	33		.0037
206	400	0	21		.0706
204	400	0	9		.8506
202**	400	0	0		.5883
202**	400	25	0		.4246
202**	400	51	0		.2646
201	400	0	-9		.1752
199	400	0	-21		.0142
197	400	0	-33		.0078
195	400	0	-45		.0050
259	800	0	-21		.0078
260	800	0	-15		.0069
261	800	0	-9		.0115
262**	800	0	0		.1215
262**	800	25	0		.1642
262**	800	76	0		.0711
262**	800	127	0		.0183
263	800	0	3		.3233
264	800	0	9		.0940
265	800	0	15		.0037
266	800	0	21		.0023

* POSITIVE ANGLES ARE CLOCKWISE DIRECTION.

** MODEL SAMPLE LOCATION HALFWAY TO NEXT HIGHEST GRID POINT.

CONCENTRATION DATA FOR RUN NO. 24
 STABILITY: SLIGHTLY UNSTABLE
 WIND DIRECTION: 315 DEG.
 RELEASE POINT: G5

SAMPLER GRID POINT	PROTOTYPE ARC (M)	ELEV (M)	MODEL DEGREES OFF* CENTER LINE	CONCENTRATION COEFFICIENT
90	100	0	45	.4659
87	100	0	27	1.4946
84	100	0	9	1.7628
82**	100	0	0	1.0514
81	100	0	-9	.9016
78	100	0	-27	.2166
75	100	0	-45	.1964
72	100	0	-63	.0365
133	200	0	-57	.0151
136	200	0	-39	.0176
138	200	0	-27	.1637
140	200	0	-15	.4747
142**	200	0	0	.7505
142**	200	25	0	.6736
142**	200	51	0	.5893
145	200	0	15	.7442
147	200	0	27	.4621
149	200	0	39	.1133
151	200	0	51	.0164
209	400	0	39	.0101
207	400	0	27	.0541
205	400	0	15	.3286
204	400	0	9	.3702
202**	400	0	0	.3135
202**	400	25	0	.2644
202**	400	51	0	.1675
201	400	0	-9	.2380
199	400	0	-21	.2229
197	400	0	-33	.0516
259	800	0	-21	.0252
260	800	0	-15	.0957
261	800	0	-9	.0982
262**	800	0	0	.1410
262**	800	25	0	.1511
262**	800	76	0	.0693
262**	800	127	0	.0453
263	800	0	3	.1398
264	800	0	9	.1461
265	800	0	15	.0718
266	800	0	21	.0302

* POSITIVE ANGLES ARE CLOCKWISE DIRECTION.

** MODEL SAMPLE LOCATION HALFWAY TO NEXT HIGHEST GRID POINT.

CONCENTRATION DATA FOR RUN NO. 8
 STABILITY: NEUTRAL
 WIND DIRECTION: 315 DEG.
 RELEASE POINT: G17

SAMPLER GRID POINT	PROTOTYPE		MODEL		CONCENTRATION COEFFICIENT
	ARC (M)	ELEV (M)	DEGREES OFF* CENTER LINE		
90	100	0	45		.3194
87	100	0	27		1.2948
84	100	0	9		2.4861
82**	100	0	0		1.8426
81	100	0	-9		2.0571
78	100	0	-27		1.0685
75	100	0	-45		.2231
72	100	0	-63		.0172
133	200	0	-57		.0092
136	200	0	-39		.0865
138	200	0	-27		.1927
140	200	0	-15		.5761
142**	200	0	0		1.0190
142**	200	25	0		.6963
142**	200	51	0		.3808
145	200	0	15		1.0170
147	200	0	27		.2673
149	200	0	39		.0337
151	200	0	51		.0145
208	400	0	33		.0145
206	400	0	21		.0983
204	400	0	9		.5623
202**	400	0	0		.4692
202**	400	25	0		.3174
202**	400	51	0		.2118
201	400	0	-9		.2521
199	400	0	-21		.0739
197	400	0	-33		.0165
195	400	0	-45		.0106
259	800	0	-21		.0139
260	800	0	-15		.0376
261	800	0	-9		.1030
262**	800	0	0		.1868
262**	800	25	0		.1485
262**	800	76	0		.0568
262**	800	127	0		.0337
263	800	0	3		.2151
264	800	0	9		.2138
265	800	0	15		.0449
266	800	0	21		.0106

* POSITIVE ANGLES ARE CLOCKWISE DIRECTION.

** MODEL SAMPLE LOCATION HALFWAY TO NEXT HIGHEST GRID POINT.

CONCENTRATION DATA FOR RUN NO. 9
 STABILITY: MODERATELY STABLE
 WIND DIRECTION: 315 DEG.
 RELEASE POINT: G17

SAMPLER GRID POINT	PROTOTYPE		MODEL		CONCENTRATION COEFFICIENT
	ARC (M)	ELEV (M)	DEGREES OFF* CENTER LINE		
90	100	0	45		.4478
87	100	0	27		1.0493
84	100	0	9		2.3138
82**	100	0	0		2.0158
81	100	0	-9		2.7067
78	100	0	-27		2.6520
75	100	0	-45		.9232
72	100	0	-63		.2525
133	200	0	-57		.0080
136	200	0	-39		.0069
138	200	0	-27		.4165
140	200	0	-15		.9165
142**	200	0	0		1.2502
142**	200	25	0		.5426
142**	200	51	0		.2759
145	200	0	15		1.2301
147	200	0	27		.3752
149	200	0	39		.0214
151	200	0	51		.0000
208	400	0	33		.0000
206	400	0	21		.0571
204	400	0	9		.6844
202**	400	0	0		.6777
202**	400	25	0		.3775
202**	400	51	0		.2089
201	400	0	-9		.2993
199	400	0	-21		.0270
197	400	0	-33		.0000
195	400	0	-45		.0000
259	800	0	-21		.0013
260	800	0	-15		.0047
261	800	0	-9		.0170
262**	800	0	0		.1955
262**	800	25	0		.2123
262**	800	76	0		.0605
262**	800	127	0		.0080
263	800	0	3		.3920
264	800	0	9		.0828
265	800	0	15		.0000
266	800	0	21		.0000

* POSITIVE ANGLES ARE CLOCKWISE DIRECTION.

** MODEL SAMPLE LOCATION HALFWAY TO NEXT HIGHEST GRID POINT.

CONCENTRATION DATA FOR RUN NO. 24
 STABILITY: SLIGHTLY UNSTABLE
 WIND DIRECTION: 315 DEG.
 RELEASE POINT: G17

SAMPLER GRID POINT	PROTOTYPE		MODEL		CONCENTRATION COEFFICIENT
	ARC (M)	ELEV (M)	DEGREES OFF* CENTER LINE		
90	100	0	45		.2493
87	100	0	27		.7384
84	100	0	9		1.0936
82**	100	0	0		1.1746
81	100	0	-9		1.0967
78	100	0	-27		.8973
75	100	0	-45		.8724
72	100	0	-63		.4611
133	200	0	-57		.0561
136	200	0	-39		.0530
138	200	0	-27		.3739
140	200	0	-15		.4362
142**	200	0	0		.5889
142**	200	25	0		.4268
142**	200	51	0		.3396
145	200	0	15		.4611
147	200	0	27		.2742
149	200	0	39		.0810
151	200	0	51		.0093
209	400	0	39		.0062
207	400	0	27		.0374
205	400	0	15		.1901
204	400	0	9		.2243
202**	400	0	0		.2150
202**	400	25	0		.1745
202**	400	51	0		.1153
201	400	0	-9		.1932
199	400	0	-21		.2025
197	400	0	-33		.0997
259	800	0	-21		.0374
260	800	0	-15		.0748
261	800	0	-9		.0841
262**	800	0	0		.1059
262**	800	25	0		.0841
262**	800	76	0		.0467
262**	800	127	0		.0312
263	800	0	3		.0966
264	800	0	9		.0997
265	800	0	15		.0467
266	800	0	21		.0187

* POSITIVE ANGLES ARE CLOCKWISE DIRECTION.

** MODEL SAMPLE LOCATION HALFWAY TO NEXT HIGHEST GRID POINT.