

Irrigation and Water Resources in the 1990's

Proceedings from the 1992 National Conference

Phoenix, Arizona

October 5-7, 1992

Sponsored by

U.S. Committee on Irrigation and Drainage

Edited by

Joseph B. Summers
Summers Engineering, Inc.

Susan S. Anderson
U.S. Committee on Irrigation and Drainage

Published by

U.S. Committee on Irrigation and Drainage
1616 Seventeenth Street, Suite 483
Denver, CO 80202
303-628-5430

USCID

The U.S. Committee on Irrigation and Drainage (USCID) is a nonprofit professional society whose members share an interest in the planning, design, construction, operation and maintenance of irrigation, drainage and flood control works; agricultural economics; water law; and environmental and social issues affecting irrigated agriculture.

USCID publishes the *USCID Newsletter*, proceedings of USCID meetings and special reports; organizes and sponsors periodic technical meetings and conferences; and distributes publications of the International Commission on Irrigation and Drainage. ICID publications include the biannual *ICID Bulletin*, *Irrigation and Drainage in the World*, and the *Multilingual Technical Dictionary on Irrigation and Drainage*.

Membership categories and dues are:

Individual.....	\$45	Institutional	\$200
Library	\$95	Corporate	\$425

The U.S. Committee on Irrigation and Drainage accepts no responsibility for the statements made or the opinions expressed in this publication.

Copyright © 1993, U.S. Committee on Irrigation and Drainage

Printed in the United States of America

Library of Congress Catalog Card Number: 93-60049

ISBN 0-9618257-8-2

PREFACE

The papers included in these Proceedings were prepared for presentation at the 1992 National Conference of the U.S. Committee on Irrigation and Drainage. The Conference, *Irrigation and Water Resources in the 1990's*, was held in Phoenix, Arizona, on October 5-7, 1992.

The purpose of the Conference was to provide a forum for specialists in all water resources disciplines to examine challenges and opportunities facing irrigated agriculture during the final decade of the 20th century. Four timely subjects were selected as sub-topics:

- Rehabilitation, Operation and Maintenance Automation
- Conservation vs. Development
- Environmental Issues
- New Technologies in Irrigation and Drainage

Papers presented at the Conference and included in these Proceedings were invited by USCID or accepted in response to the Call for Papers. Each paper was reviewed by USCID's Conference Committee Co-Chairmen prior to the Conference. Authors represent experts from academia, federal and state government agencies, water districts and the private sector.

The Conference featured the formal presentation of papers, question and answer sessions, lunch and dinner speeches by prominent water resources professionals and an exhibition of products and services relating to water resources. A day-long study tour featured the Central Arizona Project (CAP), including the CAP control center, New Waddell Dam, CAP delivery canals and irrigated agriculture in the area. More than 150 people attended the Conference.

The U.S. Committee on Irrigation and Drainage and the 1992 National Conference Co-Chairmen extend their appreciation to all speakers, authors, participants and session chairmen.

Joseph B. Summers
National Conference General Chairman
Hanford, California

TABLE OF CONTENTS

Rehabilitation, Operation and Maintenance Automation

Interdisciplinary Teams for Assessing the Performance of Irrigated Agriculture Systems by A. J. Clemmens, A. R. Dedrick, D. B. Levine, and W. Clyma	1
Using South Canal Remote Acoustic Water Level Monitoring and Flow Measurement by Roger L. Reynolds	13
Centralized Constant-Volume Control of Irrigation Canals by J. Mohan Reddy	25
Field Manufacture and Application of Reinforced Plastic Canal and Pipe Linings by Gerald Westesen and Leroy Payne	39
Improving Channel Maintenance Methods for Egypt's Irrigation Systems by Frederick F. Schantz and Robert E. Dixon	49
Using Flood Water through an Irrigation Delivery System by W. Martin Roche	59
Experience with Flexible Schedules and Automation on Pilot Projects by John L. Merriam	67
Canal Linings Used by the Bureau of Reclamation with Emphasis on Rehabilitation by Thomas R. Haider	79

Conservation vs. Development

The California Farm Water Coalition: Telling Thirsty Californians Why Agriculture Needs Water by Stephen K. Hall and Shelley Vuicich	95
Institutional Framework and Challenges in Management of Agricultural Water Use in South Florida by Vilma Horinkova	101
Technology Transfer Lessons from a U.S. Water District by Douglas Welch and Karen McLaughlin	119
Management of Water Conservation through Irrigation System Modernization and Rehabilitation by A. K. Dimmitt, K. I. McLaughlin, F. Z. Kamand, and D. G. Welch	127
Five Key Facts about Third-Party Impacts and Water Markets in California by Carl Boronkay and Timothy Quinn	137
Water Marketing Framework that Minimizes the Socioeconomic Impacts of Long-Term Water Transfers by Dennis Wichelns	147
Artificial Recharge of Groundwater by Herman Bouwer	159
Long-Term Storage through Indirect Recharge by Larry R. Dozier and Clifford A. Neal	167

Environmental Issues

Mitigating Agricultural Impacts on Groundwater through Desalination <i>by William E. Warne and Neil M. Cline</i>	1
Agriculture's Impact on Water Resources in Eastern Europe: Bulgaria, Hungary, and Romania <i>by James M. Wolf</i>	1
Nonpoint Source Pollution: Agriculture at Risk — Reauthorization of the Clean Water Act <i>by Thomas F. Donnelly</i>	2
How Probiotic Fertilizers Improve Irrigation Efficiency, Buffer Salts, and Reduce Nitrate Infiltration into Groundwater <i>by Kenneth R. Martin and Robert Ellsworth</i>	2
Hydroelectric Project Licensing: Possible Lessons for Agricultural Water Users <i>by Richard A. Westmore</i>	2
Mitigating Environmental Impacts of Water Management Projects: Examples <i>by Michael Day, Brian Ehlers and Dale Melville</i>	2
Central Valley Project Water Supply Shortages <i>by Chester V. Bowling</i>	2
Drought, Supply Shortages and E.S.A. Can the Farmer Survive? <i>by Jean P. Sagouspe</i>	2

New Technologies in Irrigation and Drainage

Avoiding Pitfalls in Canal Automation <i>by B. T. A. Sagar</i>	2
AZSCHED Computer Software for Irrigation Scheduling <i>by Lee J. Clark, Donald C. Slack, Edward Martin and Fred A. Fox, Jr.</i>	2
Determination of Irrigated Crop Consumptive Water Use by Remote Sensing and GIS Techniques for River Basins <i>by David G. Wagner, Terence H. Podmore and Roger M. Hoffer</i>	2
GIS and Conjunctive Use for Irrigated Agriculture <i>by J. W. Fredricks and J. W. Labadie</i>	2
Mapping Technology in the '90's for GIS Applications to Irrigation and Drainage <i>by Larry J. Edwards</i>	3
The Use of Satellite Data Relay by the U.S. Geological Survey for Near Real-Time Hydrologic Data Collection <i>by William G. Shope, Jr.</i>	3
Reaching to the Sky: Cloud Seeding for Water Supply <i>by Maurice Roos</i>	3

Appendix

Participant Listing	3
---------------------------	---

INTERDISCIPLINARY TEAMS FOR ASSESSING THE PERFORMANCE OF IRRIGATED AGRICULTURE SYSTEMS

A.J. Clemmens¹
A.R. Dedrick³

D.B. Levine²
W. Clyma⁴

ABSTRACT

The Management Improvement Program (MIP) provides a comprehensive methodology for supporting improvement in the profitability and sustainability of irrigated agriculture. Diagnostic Analysis (DA), the MIP's first phase, relies heavily on an interdisciplinary team to assess the performance of irrigated agriculture and provide the foundation for subsequent performance improvements. Small group processes are used to build an effective interdisciplinary team and to frame and concur on understandings that integrate the various disciplinary perspectives. This process compels individuals with diverse technical backgrounds to acquire a holistic understanding of an irrigated agriculture system: farm and district economics, on-farm cultural practices, and water management from source to farm gate to field. Structured, periodic professional facilitation is necessary to build and maintain an effective DA Team. Facilitation also helps to assure that all team members actively engage in developing accurate, complete findings that represent the current performance of irrigated agriculture in the study area. Further, stakeholders must be able to understand the DA Team's description of current performance, so they can identify, plan, and carry out needed improvements. A case study is described in which the DA results were received positively and are being used successfully in the subsequent Management Planning Phase.

INTRODUCTION

In many parts of the world, including much of the western United States, irrigated agriculture depends on large-scale water delivery systems. The performance of these systems influences farm irrigation systems, crop

¹Research Hydraulic Engineer, USDA/ARS U.S. Water Conservation Laboratory, Phoenix, AZ 85040

²Private Consultant, Washington, DC

³Director, U.S. Water Conservation Laboratory

⁴Professor, Dept. of Agricultural and Chemical Engineering, Colorado State University, Ft. Collins, CO

water management, crop selection, yields, and ultimately, farm profit. For many irrigation projects, improvements in water management, yields, and profitability are necessary to ensure sustainability and economic viability of irrigated agriculture. To be effective, growers, irrigation districts, and support and regulatory organizations must interact in ways that leverage their own resources to improve overall agricultural profitability, long-term resource management and environmental sustainability, and social well-being. For change in performance to be successful, the problems constraining performance improvement must be understood correctly and the full range of likely causes assessed accurately.

In general, addressing these problems is also complex and rarely as simple as applying generic solutions. For example, if the real problems are related to inappropriate policies, then adopting "off-the-shelf" technology such as canal lining or new gates will not achieve the performance impact sought. Rather, the Management Improvement Program (MIP) incorporates the following concepts: (1) a thorough understanding of the performance of the entire irrigated agriculture system in an area (on-farm, delivery, and the broader context), (2) involvement by key decision makers from all entities involved in irrigated agriculture in joint decision-making processes, and (3) planning and implementation of change by operational managers responsible for performance. The key goal of the MIP is to improve irrigated agriculture's sustainability and profitability. Central to the MIP's methodology is the focus on the realities of growers' individual circumstances and on obtaining their direct input and involvement throughout the process.

The MIP is structured into three phases: Diagnostic Analysis (DA), Management Planning (MP), and Performance Improvement (PI). The DA yields an understanding of the performance of irrigated agriculture in the area and provides insight into the causes of high and low performance. During MP, the growers and organizations involved with irrigated agriculture in the area develop a shared understanding of the current performance and its causes and use that understanding to develop a set of coordinated management plans. During PI, the organizations and growers begin implementing the management plans and continue to monitor results, diagnose problems, and replan improvements. More detailed information on the MIP process can be found in Dedrick et al. (1989, 1992, 1993), Clyma and Lowdermilk (1988), and Jones and Clyma (1988).

In this paper, we describe the DA Phase as it was carried out for a demonstration MIP in Arizona. In particular, we focus on the DA Core Team, on its membership, roles, and responsibilities; the small group processes through which it developed the DA findings; and on how the DA methodology differs from traditional approaches to irrigation system performance assessment.

MSIDD DIAGNOSTIC ANALYSIS

A DA was performed within the Maricopa Stanfield Irrigation and Drainage District (MSIDD) during 1991 (Dedrick et al. 1992). MSIDD is located in hot, arid, central Arizona, receives surface water from the Central Arizona Project (CAP), and pumps groundwater. Water potentially is delivered to 34,000 ha from an open channel distribution system, primarily to surface-irrigated cotton.

The end product of the DA was an interdisciplinary understanding of the current performance of irrigated agriculture in the MSIDD area (DA Report, Dedrick et al. 1992). This performance understanding, as reflected in the DA Report, was used to initiate the MIP's Management Planning (MP) Phase currently underway and is the primary reference for the development of management plans to improve performance.

Though the DA involved a wide range of individuals to provide, clarify, and refine relevant data, the assessment itself was conducted by a DA Core Team consisting of nine members: five representing disciplinary perspectives (on-farm water control, delivery system water control, economics, farm productivity, and social-organizational relationships), two MIP consultants (a Management/Team Planning Specialist and an MIP Specialist), a DA Team Leader, and a program and management assistant. Agencies providing the DA Core Team members included the US Department of Agriculture Soil Conservation Service and Agricultural Research Service, the State of Arizona Cooperative Extension, and the University of Arizona College of Agriculture. A somewhat larger DA Resource Team consulted periodically with the Core Team, assisted in planning the DA, and functioned as an information resource and sounding board during the DA fieldwork and an initial review group for the DA findings. The Resource Team consisted of about 20 individuals representing the MSIDD staff and Board of Directors, growers, outside consultants, and representatives from the above

agencies, the State of Arizona Departments of Water Resources and Environmental Quality, and the US Department of Interior Bureau of Reclamation.

DA planning and preparation (March through June 1991) included selecting the DA Core and Resource Teams, clarifying the DA purpose and approach, clarifying individual and team DA roles, planning data collection, and developing sampling strategies and data collection materials.

Data collection and interim analysis, summary, and synthesis (May through August 1991) included obtaining information from personal interviews, district records, and published background sources. Growers (25), along with some foremen and irrigators; MSIDD staff (30), ranging from all of upper management to a sample of canal operators; and the MSIDD Board of Directors (9) were interviewed by the DA Core Team. Details of the sampling strategy can be found in Dedrick et al. (1992). The DA Core Team periodically summarized, analyzed, and synthesized the data gathered.

Final synthesis, formulation of the DA findings, and development of the DA Report (August 1991 through March 1992) included the DA Core Team's final synthesis of the data and formulation of its findings and review sessions with the DA Resource Team, MSIDD's Board of Directors, MSIDD Management, and the area's growers. These reviews assisted in assuring that the DA findings were accurate and complete, that they were presented clearly and reflected a neutral perspective, and that they did not prescribe solutions. Other DA activities included development and review of the DA Report and establishment of linkages to the MP Phase. Unlike the above presentation of activities, in actuality, the DA dynamically combined ongoing, often simultaneous, data collecting, planning, summarizing, and synthesizing activities. Also, although these activities extended from March 1991 through March 1992, they were periodic and amounted to 3 or 4 months of DA Core Team effort.

DIAGNOSTIC ANALYSIS METHODOLOGY

The management of crop production is a complex task, crossing many technical disciplines. The geographic, economic, and legal context of the agricultural production system increases the complexity. The DA approach addresses actual performance assessment within this broad context. Because virtually no non-trivial performance problems can be solved without addressing multiple subsystems, interactions, and technical

components, the DA approaches performance assessment from an interdisciplinary perspective. This section describes the processes employed to assure that the DA findings painted a complete, accurate picture of the performance of irrigated agriculture in the area and provided a basis for planning appropriate improvements.

DA Planning, Preparation and Data Collection. A meeting between the DA Core and Resource Teams provided the Core Team with initial objectives, performance measures, areas of inquiry, data sources, etc., for various parts of the irrigated agriculture system. The objectives and performance measures were general (e.g., Returns to farming are sufficient to sustain well-managed irrigated agriculture in the district).

The Team Planning Methodology (TPM, Levine 1989) was used to guide the DA activities as the Core Team gathered and synthesized a large amount of data, and shaped it to provide an accurate, comprehensive, and consistent picture. Each of the findings--statements of overall performance as well as identification of specific causes of that performance--were concurred in by all members of the Core Team. Each field interview was carried out by two or more team members using a structured approach, sensitive to both process and content. Interview questionnaires were designed to gather the information required by each DA Core Team member to develop both disciplinary and interdisciplinary understanding of the system. As a result, each team member relied on data collected by others and was responsible for gathering data for others. This blending of disciplinary experience enlarged each member's technical perspective.

As a starting point, the DA team hypothesized a set of performance statements. In the ongoing process of summarizing and synthesizing their understanding, team members replaced the hypotheses with new Performance Statements that more clearly described their observations. For each Performance Statement, the team wrote an Impact Statement, specifying how that performance would affect the profitability and sustainability of the system, and a set of Contributing Factors, identifying the primary causes of the level of performance, including a limited amount of explanatory information or supporting data. The specification of contributing factors (i.e., causes for high or low performance) is a key feature of the DA approach. This identification of causes links directly to identifying important opportunities for performance improvement in the study area. Only Performance Statements considered by the Core Team

to have significant performance impact were included in the final DA findings. Prioritization of Performance Statements would be done during the MP Phase.

Interim Analysis, Summary and Synthesis. The DA Core Team's interim analysis, summary, and synthesis processes were critical parts of their DA work. In essence, the final DA synthesis was simply the last iteration of an activity that began when the first data were collected. The process can be described as re-telling the story of what is going on with irrigated agriculture in the area. The story, however, must accommodate all the data, as well as the various disciplinary interpretations of the individual DA Core Team members. When elements are contradictory or suggest incompatibility, further data gathering and reinterpretation are required; when new data either suggest missing chapters of the story or undercut current aspects, more work and discussion of what has been learned are required. Each reiteration of the story represents a consensus among Core Team members, not just agreement of a majority. Members were urged to apply their disciplinary perspectives rigorously, to clarify for each other any technical matters that might block full understanding and to verify any data that seemingly could not be accommodated.

Early iterations of Performance Statements were challenged and changed, usually because, they oversimplified or overstated a condition, ignored important district history or impacts from the broader context, or had a more negative tone than proved accurate in terms of the larger picture. Also, performance strengths were sometimes omitted or not explicitly stated. An example of the evolution of a particular Performance Statement follows:

Final Performance Statement from Dedrick et al. (1992):

Soil-building conservation measures such as the use of small grains, alfalfa, cover crops, manure, and reduced tillage systems are inadequately employed to sustain the farming system.

Examples of prior statements are

Farmers are destroying their soil.

Farmers are using too many tillage operations on their fields.

Final Synthesis, Formulation of the DA Findings, and Development of the DA Report. The results of the DA were shared with the area's growers, as well as all organizations involved with irrigated agriculture in the area. There were several thrusts to these discussions. One was the clarity and ease of understanding of what was written. Did everyone understand what the team meant to say? A second thrust was correctness. Were the statements accurate, and if not, what corrections were needed? Another aspect was tone. Was it neutral, not negative; neither patronizing nor condescending? A final thrust was comprehensiveness. Were additional statements or contributing factors needed to describe performance fully? And if so, were potential additions substantiated by the DA work completed, or were more data required? These considerations were essential to obtaining the virtually unqualified acceptance of the results by stakeholders who would be planning and implementing improvements.

Throughout these reviews, though most of the performance statements had been reworded or modified in some way, content had not been compromised. That is, the Core Team did not modify its conclusions for political reasons or to avoid controversy. In general, it was able to satisfactorily address issues raised by all parties, including MSIDD management and growers. The widespread concurrence in the DA findings is important confirmation of the ability of the process to yield its intended product. This acceptance has continued throughout the MP Phase, with the findings being used and built upon as plans are developed.

QUESTIONS REGARDING THE DA APPROACH

A number of the more frequently asked questions about the DA process are addressed below, with answers based primarily on the experiences of the MSIDD-Area DA.

Is an interdisciplinary team necessary for a thorough and accurate irrigated agriculture system performance assessment?

The findings of the MSIDD area's DA address multiple system components and are clearly interdisciplinary in both their statement and their supporting data. Even when Contributing Factors (CFs) are single discipline oriented, the set of CFs for a given Performance Statement represents a combination of disciplinary perspectives. Given that actual performance is a result of causes across disciplines and across system components,

an accurate and useful performance assessment should be interdisciplinary. Consider the Performance Statement:

Though MSIDD's ultrasonic flow meters are effective for water accounting and billing purposes and for operational management if properly used, they are rarely used by growers as management tools, and in general it appears they could be used more effectively by MSIDD personnel.

Such a statement would not have resulted from analysis by any single discipline expert, yet this statement clearly describes the current use of these meters.

How do interdisciplinary DA results improve the likelihood of achieving performance improvement?

First, interdisciplinary Performance Statements are more likely to describe actual performance, since real systems are complex with many interactive components. Second, identifying the causes of problems is as important as identifying the problems themselves. Third, this process continually strives to remain neutral and nonjudgmental, focusing on understanding and description, and neither blames nor attempts to find solutions. Finally, the process involves key stakeholders in an active role from the onset. The "ownership" thus engendered was critical to the acceptance of and confidence in the DA results expressed by all involved with the MSIDD Area DA.

In what ways are this interdisciplinary DA approach to performance assessment new?

Clearly, irrigated agriculture performance assessments and small group processes are not new. The newness lies in the combination of these elements with an interdisciplinary scope and a system/subsystem focus. In our view, this union makes both the approach and the process new.

With an interdisciplinary approach, statements of performance often cross both disciplinary boundaries and subsystem boundaries (e.g., farm and district subsystems, or agronomic and economic subsystems). This is a new kind of product.

How was team-building facilitated?

Team-building was facilitated in several ways. Team members were divided into small groups for various tasks. The Core Team process required confident

individuals with solid disciplinary commitment and understanding. Each team member brought different skills and different communication abilities and styles of interaction. Each also differed in the desire and ability to advocate ideas. To prevent strong personalities from dominating, the role of the facilitator was to focus that strength in positive directions for achieving the Team's goals and to encourage less forceful team members to speak up.

All team members were considered as equals; all opinions were valued. At the same time, all opinions were subject to challenge, and their acceptance resulted from building team-wide understanding. Team members committed themselves to active participation and were discouraged from withdrawing from the work at hand. All were encouraged to contribute, and when one team member disagreed with others, facilitation sought to assist that member in representing his/her perspective, without defensiveness, until the entire team was in agreement. Confrontations were treated as work-based rather than personal--focusing on the issue and not the person.

How did the team function?

The process used in the MSIDD-Area DA combined methods for strategic structuring of development efforts and guiding small group processes (Levine 1989) with the DA approach for assessing the performance of irrigated agriculture (Lowdermilk et al. 1983).

Team members initially agreed on their roles and a set of ground rules to carry them out (e.g., speak up if you have something to contribute, express agreements/disagreements). Each team member had to accept responsibilities for representing his/her disciplinary perspective and to be accountable for generating certain products (e.g., portions of questionnaires, interviews, Performance Statement Drafts).

Often when team members spoke from their own disciplines, there were questions of clarification or challenges to the particular perspective. After some debate, the team focused on what was correct about the statement, i.e., what they could believe, as opposed to what they could not concur in. In many cases, rephrasing made a statement acceptable. Usually, the disagreement resulted from overstatement of the problem or overgeneralization from insufficient data. At first, members of the team were concerned that the process would "water down" the statements. However,

as work progressed, it was usually evident that the new statements were a clearer, more accurate representation of the actual situation. On the other hand, unimportant issues were discarded since they did not merit the team's time and attention.

How did the team achieve interdisciplinary results?

To achieve interdisciplinary effectiveness, DA Core Team members must solidify their understanding of each other's perspectives and the implications of those perspectives on data to be gathered and conditions to be understood. This knowledge is then used in several ways. First, interview teams ask interview questions pertaining to all disciplines. Also, when a finding is stated by any team member, either preliminarily or as a formal Performance Statement, each team member must understand the statement well enough to enrich it by integrating additional disciplinary perspective as well as to agree, disagree, or request additional verification. Statements or propositions were accepted only if all other members concurred (that is, majority rule was not used). No single discipline was allowed to dominate the results.

Perhaps most importantly the very process of synthesizing information often had synergistic effects. There were many cases during the DA when information from one farm interview appeared to contradict something learned in another farm or MSIDD staff interview. Usually, these apparent contradictions resulted from the Team's incomplete understanding of subtle differences in context. The process of openly grappling with the apparent contradictions usually enhanced the Team's understanding of the real performance and conditions contributing to it.

The DA process is an iterative process of collecting data, synthesizing results, and describing current performance. For each iteration, data are incomplete, analyses are incomplete, and understandings are incomplete. The process also moved from specifics to generalization cyclically. For example, after a group discussion of one or more specific technical points, the team was requested to express its understanding of these points in a general way, with supporting evidence, including an assessment of the impact on production, water use, profitability, etc. By being forced to describe the Team's current understanding, each member was obligated from the beginning to broaden his/her perspectives on issues and to see where and how individual disciplines and understandings fit into the

overall picture. When this occurs, the team member is functioning in a truly interdisciplinary fashion.

What conflicts occurred and how were they resolved?

The team members were eager for more data and more analysis of existing data, while the DA leaders pushed for clarity and closure on identified performance areas or statements. Periodic tension and resistance to the process was to be expected, but pride in the progress and quality of the work continued to grow.

Most of the Core Team members were "borrowed" from their respective agencies and had other jobs. Thus, time was a premium for most, yet the DA is a time-consuming process. However, all members developed a strong commitment to the process, to the team, and to the importance of a high quality result.

What are the drawbacks to this approach?

There is a cost for achieving the interdisciplinary DA understanding. Combining the disciplinary perspectives into a concise performance statement takes time. However, the quality of the results, in our opinion, justifies this cost.

How do you select team members?

Team membership requires individuals who are technically competent in their disciplines, as well as individuals who are intimately familiar with the local area and conditions. Technical strength is needed to make proper inference from causal relations, while local knowledge is needed to provide the proper focus.

Important criteria for team membership are openness and the willingness to discuss issues. Defensiveness is counterproductive. Team members must be capable of both examining technical details and viewing the system in a broad context. Equally important is the ability to move logically from specific technical details to assessing impact on general conditions.

What do team members get out of it?

Team members universally felt they achieved a greater understanding of irrigated agriculture. Those from local agencies also learned how their agencies and impact were perceived by farmers. All team members felt enriched by the experience and had a clear sense of accomplishment. Finally, team members learned to

address problems in a way conducive to change and improvement.

REFERENCES

1. Clyma, W. and M.K. Lowdermilk. 1988. Improving the management of irrigated agriculture: A methodology for diagnostic analysis. D. Fowler, Editor. Water Management Synthesis II Project. WMS Report 95. Colorado State University, Ft. Collins, CO. 88 pp.
2. Dedrick, A.R., et al. 1992. The Demonstration Interagency Management Improvement Program (MIP) for Irrigated Agriculture in the Maricopa-Stanfield Irrigation and Drainage District (MSIDD); Vol. I, The Diagnostic Analysis (DA) Report of the MSIDD Area MIP. USDA-ARS, USWCL IMIP Doc. 5, March. 99 pp., and Vol. II, The DA Findings, Supportive Data, and Supplemental Materials. USDA-ARS, USWCL, IMIP Doc. 6. July. 118 pp.
3. Dedrick, A.R., W. Clyma and J.D. Palmer. 1989. A management improvement process to effectively change irrigated agriculture. P. 45-58 In A.S. Anderson, J. Schaack and D.S. Wilson Jr. (eds.) Planning for water shortages. Proc. of 1989 Meeting USCID, Boise, ID. 24-26 Aug. 1989.
4. Dedrick, A.R., et al. 1993. A demonstration irrigation Management Improvement Program. In: Proceedings of the Fifteenth Congress, ICID, Aug. 30-Sept. 12, The Hague, The Netherlands. (Presented at the Twelfth Technical Conf., USCID, Nov. 1991, San Francisco, CA).
5. Jones, A.L., and W. Clyma. 1988. Improving the management of irrigated agriculture: The management training and planning program for command water management, Pakistan. D. Fowler, Editor. Water Management Synthesis II Project. WMS Professional Paper 3. Colorado State U., Ft. Collins, CO. 14 pp.
6. Levine, D.B. 1989. The team planning methodology: Shaping and strengthening development management. Unpub. Working Paper, OICD, USDA, Wash., DC, 38 pp.
7. Lowdermilk, M.K., et al. 1983. Diagnostic analysis of irrigation systems, Volume 1: Concepts & methodology. D. Fowler, editor. Water Management Synthesis Project, Colorado State U., Ft. Collins, CO.

**PUTAH SOUTH CANAL REMOTE ACOUSTIC
WATER LEVEL MONITORING AND FLOW MEASUREMENT**

Roger L. Reynolds*

ABSTRACT

The Putah South Canal (PSC) was constructed as a part of the Solano Project by the U. S. Bureau of Reclamation for the conveyance of water to the agricultural and urban member units of the Solano County Water Agency in California. The Solano Irrigation District (SID) operates the PSC for the member units. Average annual deliveries are approximately 200,000 acre feet.

The PSC has 12 manually operated radial gate check structures which are used to control the flow in the canal throughout its 33 mile length. Prior to the installation of the monitoring equipment, SID did not have the ability to instantaneously monitor the PSC flow status. When unanticipated delivery changes occurred, increases or decreases in the PSC flows often went unnoticed for several hours. The flow monitoring system installed during the winter of 1991-92 includes acoustic water level monitoring and radio telemetry equipment at each of the PSC check structures. The equipment measures the upstream and downstream water levels and then based on the measured head loss, gate opening, and radial gate parameters, calculates the flow through each of the radial gates. The flow and water depth data are continuously transmitted to the District office. This information provides the District with the ability to more efficiently monitor and manage the delivery of water in Solano County.

SOLANO IRRIGATION DISTRICT HISTORY

The Solano Irrigation District was organized in 1948 in accordance with the provisions of the California Water Code. The District, shown in Fig. 1, is located midway between Sacramento and San Francisco and comprises approximately 56,000 irrigable acres in Solano County.

*Senior Engineer, Summers Engineering, Inc., Hanford, California

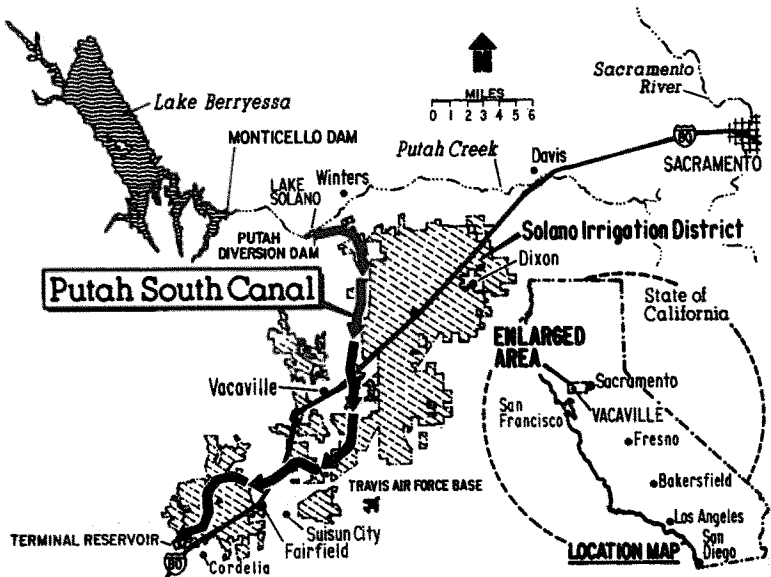

Fig. 1 Solano Irrigation District Location Map

Principal crops are corn, wheat, sugar beets, tomatoes, fruits, nuts and irrigated pasture. The District's water supply is obtained from Putah Creek by the Solano Project, constructed by the U.S. Bureau of Reclamation in the late 1950's. The project's principal facilities are Monticello Dam and its reservoir, Lake Berryessa, the Putah Diversion Dam 6 miles below Monticello Dam, and the Putah South Canal which conveys water to the agricultural and urban member units of the Solano County Water Agency. The Solano Project was initially conceived, developed and brought to fruition through the efforts of the District and Solano County. Average annual deliveries from the project are approximately 200,000 acre feet. The District annually receives approximately 151,000 acre feet from the Solano Project. The remaining member units of the Solano County Water Agency are urban entities. The majority of their municipal and industrial water supply is conveyed by the PSC.

The District's distribution system, designed and constructed in the same time period as the Solano Project, consists of approximately 115 miles of open canal, 185 miles of pipeline, and approximately 70 miles of open drainage channels. Summers Engineering, Inc. has been engineer for the Solano Irrigation District for nearly 30 years.

PUTAH SOUTH CANAL OPERATION

The PSC, depicted on the District Map in Fig. 1, is the water conveyance facility of the Solano Project. The PSC is approximately 33 miles in length from its headworks at the Putah Diversion Dam to its end at the Terminal Reservoir near Cordelia. The PSC is a concrete lined canal. The canal has 5 distinct reaches from its headworks to the terminus. The maximum capacity of the first reach is 950 cubic feet per second decreasing to a capacity of 180 cubic feet per second at its terminus. The PSC was constructed with 12 radial gate check structures along its alignment. The checks (Fig. 2) are manually operated to maintain the necessary flow in the canal and to provide the required water surface for upstream diversions.

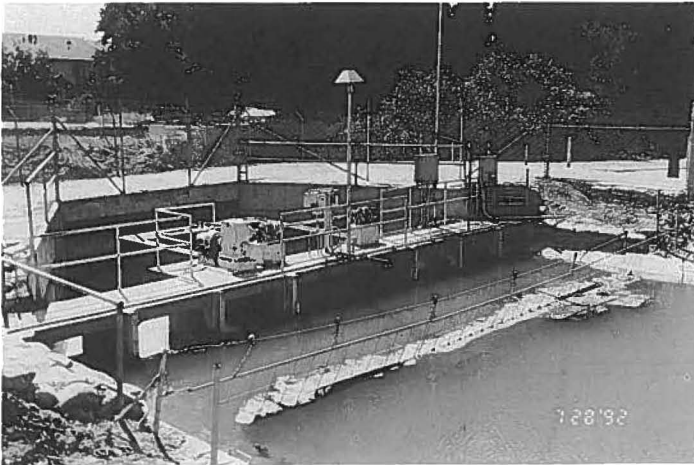

Fig. 2 Typical PSC Check Structure

Since completion of the Solano Projection, the District, under contract with the Solano County Water Agency, has been responsible for the daily maintenance and operation of the PSC. The canal was designed as a manually operated water delivery system. Water orders by farmers or urban agencies must be placed by 2:00 p.m. of the day prior to delivery. Each morning the Putah Diversion Dam operator changes the gates at the PSC headworks to meet the flow requirements for the day. The PSC Water Tender begins early each morning driving to the various check structures along the canal alignment, checking for problems, measuring the flow and changing the radial gate openings to accommodate the day's

flow requirements. It takes approximately one half of the work day to drive to all the check structures, measure the flow and make the necessary changes. The Water Tender then retraces his steps in the afternoon, double checking the operation of the various check structures, and verifying that everything is operating properly.

Shortly after construction of the PSC, flow charts were developed for the various radial gates to give the operators the ability to measure the approximate flow through each check structure. The flow charts developed were based on the Orifice Equation.

$$Q = C G_o W \sqrt{64.4 (H_1 - H_2)}$$

C = Coefficient of 0.7

W = Radial Gate Width

Figure 3 displays the other parameters used in the Orifice Equation.

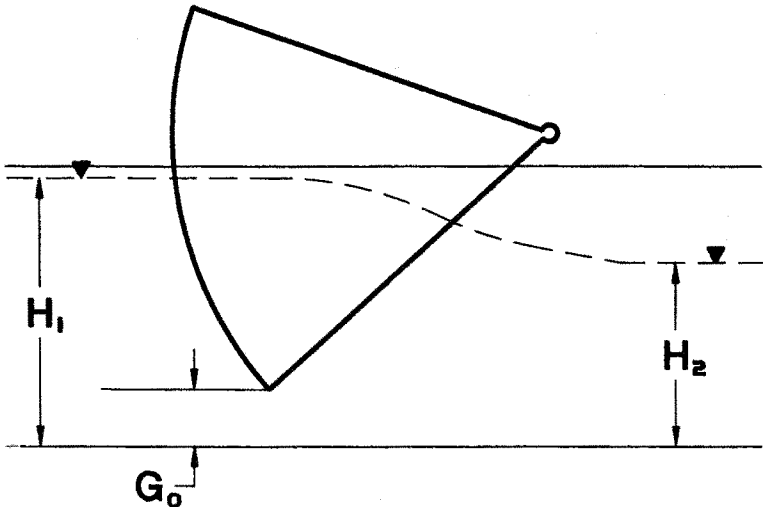

Fig. 3 Parameters Used for Orifice Equation

Staff gauges were installed at each check to allow the operator to read the upstream and downstream water levels. Markings were inscribed on the sidewalls of each radial gate as well as on the radial gate hoist

mechanism to allow the operator to measure the gate opening. Based on the water level differential and the gate opening, the operator estimated the flow through the check structure using the flow charts. The flow charts have been used to manage and operate the flows through the PSC for the past 33 years.

The PSC has three side spills along its alignment. When unanticipated flow changes or emergencies increase the flow of water in the canal above the side spill elevations, excess water is spilled down wasteways that flow into existing creeks. Minor operational fluctuations continue down the PSC and are stored in the downstream canal reaches. As a manually operated system, unanticipated delivery changes, emergencies, vandalism, or miscellaneous operational errors may occur at any given time. Although the Water Tender and the PSC maintenance staff drive the canal daily, there are periods of time when changes in the flow regime may go unnoticed for several hours, allowing water to be lost from the Solano Project and also creating circumstances where possible damage may occur to the PSC.

The District realized their flow monitoring limitations and in 1987 constructed a test installation which included acoustic water level measuring sensors on the upstream and downstream side of one radial gate check structure. The sensors measured the water levels in the canal and transmitted the data to a radio telemetry unit which at regular intervals transmitted the water level data to the District Office. The data was downloaded to a computer programmed to calculate the flow at the check structure using the Orifice Equation. While the test installation did have some minor problems in operation, the District was pleased with the continual flow monitoring possibilities it could provide for the PSC and felt similar measuring equipment along with a high and low water level alarm system should be installed at all of the check structures to improve the efficiency of operating the PSC. What the District was lacking, however, was a funding source for such a project.

WATER CONSERVATION

During 1988 Solano Irrigation District applied to the Department of Water Resources for a loan under the Water Conservation and Water Quality Bond Law of 1986, to fund the installation of acoustic water level monitoring equipment, radio telemetry transmitters and the necessary software to provide a system which would continually monitor the flows of the PSC at the various check structures. The loan was approved based on the determination that the ability to continually monitor the actual

water storage and flows in the various PSC reaches would provide the District the ability to quickly respond to operational changes or emergencies and thus minimize water losses. It was estimated from historic data on water losses and the operation of the PSC, that the proposed project had the potential of conserving approximately 2,400 acre feet per year.

PROJECT FORMULATION

The loan under the Water Conservation and Water Quality Bond Law of 1986 was finally approved in late 1989. While reviewing the proposed project requirements, it was recommended that the water monitoring system be configured as a two way talk through communications network with a central station computer capable of monitoring and accessing each remote field station. The test installation installed and operated by the District in 1987 was a one directional type of system. Data could only be sent from the check structure to the District office. The District office did not have the ability to access the monitoring equipment at the check structure to verify water levels or any of the measured parameters. The rapid improvement in radio telemetry, computer equipment, and software created a situation where the District thought it would be better to design a system that would not only receive the measurement data but one which could communicate with each remote site to verify its status. A system designed in this manner would have the potential of being expanded in the future to not only monitor but also remotely control the radial gates at each check structure. The PSC water level monitoring and radio telemetry equipment has the capability of being expanded in this manner.

A predominant goal in developing the project was to provide a system which would accurately monitor the water levels and flows in the Putah South Canal, sending alarms when the radial gate or equipment were tampered with or any predetermined water levels were exceeded. A system with this capability or with these characteristics would provide the District Watermaster with the ability to more efficiently operate the PSC. He would instantaneously know all flows, water levels, and approximate water storage quantities for each reach along the PSC.

Accurate flow measurement calculations at each check structure were a necessity for the project. As mentioned, charts developed from the Orifice Equation were the basis for the present flow measurement and operation of the PSC. A review was made of existing studies which analyzed the flow through radial (tainter) gates. One of the most useful

analyses on radial gate flow characteristics was by Arthur Toch¹. Toch expanded previous work on developing discharge coefficient data for radial gates for free flow and submerged flow conditions. The analysis presented by Toch provides the basis for using the geometric parameters of a radial gate to calculate its respective discharge coefficient and flow.

The radial gate check structures along the Putah South Canal operate in a submerged condition in the majority of all operating situations. By making a few minor modifications to Toch's submerged flow equation, the following Modified Toch Equation was developed to calculate the flow at each PSC check structure:

$$Q_s = FH_2W \sqrt{\frac{64.4(H_1-H_2)}{\psi+1-\left(\frac{H_2}{H_1}\right)^2}}$$

The parameters and variables used in this equation are defined below and in Fig. 4

$$\psi = \left(\frac{1}{\beta}\right)^2 - 1 + \frac{\gamma^2 (\beta-1)}{\gamma\beta - 2(\alpha-1) - \sqrt{[2(\alpha-1) - \gamma\beta]^2 - \gamma^2(\beta^2-1)}}$$

$$\alpha = \frac{H_2}{D G_o} \quad \beta = \frac{H_1}{H_2} \quad \gamma = \left(\frac{H_2}{C_c G_o}\right)^2 - \left(\frac{1}{\beta}\right)^2$$

$$C_c = 0.76 + \left[\left(\frac{\theta-40}{50}\right) (-0.14)\right]$$

$$\theta = \cos^{-1} \left(\frac{A-G_o}{R}\right)$$

¹ Discharge Characteristics of Tainter Gates by Arthur Toch, Paper No. 7720 ASCE Transactions, October 1952

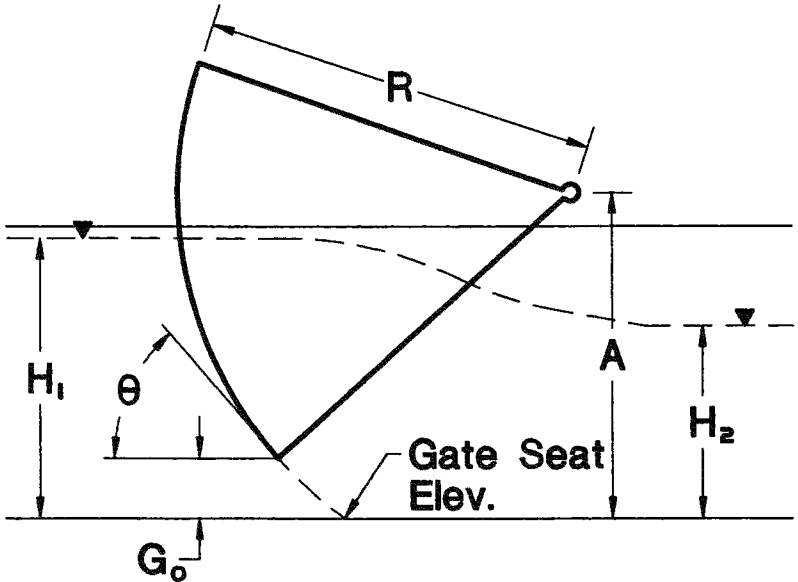

Fig. 4 Parameters Used for Modified Toch Equation

Variables Measured by Flow Monitoring Equipment:

H_1 = Upstream Water Depth (Ft.)

H_2 = Downstream Water Depth (Ft.)

G_o = Gate Opening (Ft.)

Operator Defined Variables

F = Correction Factor (Enter as 1.0 at present)

D = Alpha Denominator Correction Factor

A = Height of Gate Axis above Gate Seat (Ft.)

R = Gate Radius (Ft.)

W = Gate Width (Ft.)

A comparison of the calculated flows through a radial gate using the Orifice Equation and the Modified Toch Equation for equivalent upstream and downstream water levels and varying gate openings is plotted in Fig. 5.

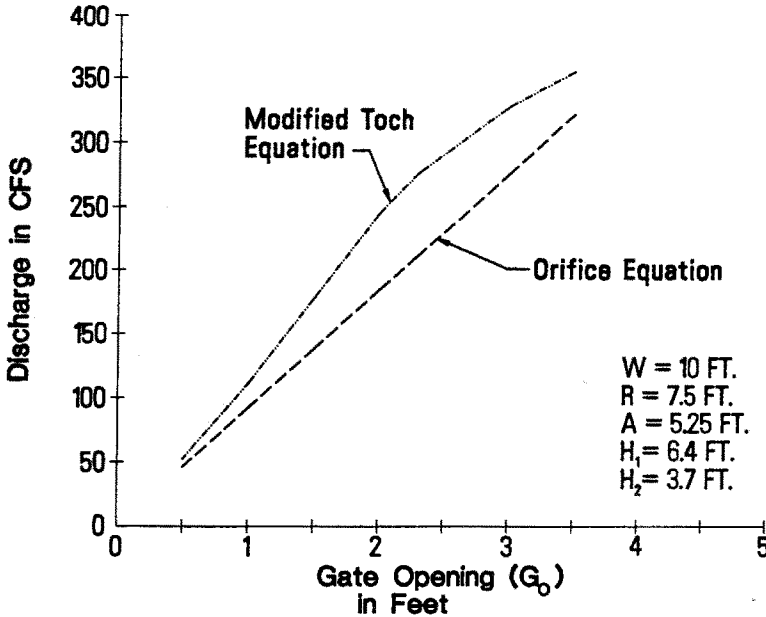

Fig. 5. Flow Equation Comparison

The theoretical equation developed from Toch's analysis was logical and accounts for the wide variation in the coefficient of discharge through radial gate structures. Nevertheless, there was a concern that model studies would be required to verify the accuracy of the equation. During the early 1980's the U.S. Bureau of Reclamation made an in-depth analysis of discharge algorithms for canal radial gates.² The Bureau's work included numerous field investigations and flow measurements at existing radial gate structures in California. At each site, current meter measurements were made to determine the flow under varying head and gate openings. Using the site specific geometric parameters provided in the Bureau's report, the Modified Toch Equation was used to

² Discharge Algorithms For Canal Radial Gates by Clark P. Buyalski, U.S. Department of the Interior, Bureau of Reclamation Engineering and Research Center, December 1982

independently recalculate the flow at the various test locations. The results indicated the Modified Toch Equation was more accurate in estimating the flow than the Orifice Equation. The flow using the Modified Toch Equation was within 5% to 10% of the actual current meter measurements. Once the District's new system is fully operable, current meter measurements will be made to verify and/or adjust the equation as required.

SYSTEM OPERATION

Two acoustic sensors are installed at each PSC check structure. By echo technology, the sensors measure the distance to the upstream and downstream water surfaces. Knowing the distance from the sensors to the canal invert allows the respective water depth to be calculated. An encoder attached to the shaft of the radial gate hoist mechanism allows the gate opening to be calculated. The data from each sensor and the encoder is transmitted to a remote telemetry unit (RTU) at each site which stores the data and at preset intervals, calculates the flow using the Modified Toch Equation and then transmits the gate parameters and calculated flow to the District central station. High and low water level alarms are programmed into each RTU. If an alarm is exceeded, a warning message is transmitted to the central station and a warning light flashes at the respective structure on the computer's graphic video display of the PSC. Alarms are also programmed into the system for low battery power or power loss at any given site, if communication is lost between any of the sensors or RTU's, if an RTU is tampered with, and if the water level measurements exceed a preset variation. If an alarm is received at the central station and an operator does not log into the computer in response to the alarm, an automatic dialing system begins calling a list of "on-call" operators to notify them of the alarm.

The operating system software maintains and continually updates a data base of all water level and flow measurements. Graphs and/or charts summarizing the flow measurements for any period of record can quickly be developed. The software also includes an area capacity curve for each canal reach upstream of a check structure. This provides the Watermaster with the capability of quickly determining the amount of water in storage in the PSC.

CONCLUSION

The District installed the acoustic water level monitoring equipment, radial telemetry equipment and the central station computer during the winter of 1991-92 for a cost of approximately \$200,000. Some installation problems and software debugging are still taking place. Changes and modifications to the system will probably be required in the future as the District becomes familiar with operating its automatic water level and flow monitoring system. The system was not fully operable during the summer of 1992 and at this time it is too early to analyze the benefits of the system in helping the District more efficiently operate the Putah South Canal. The Watermaster and District Water Operations Supervisor are convinced, however, that the new system will improve operations by giving the District the ability to instantaneously monitor the flow throughout the 33 mile length of the Putah South Canal, and automatically provide warnings if operational changes or vandalism affect the flow and require immediate attention. Daily driving of the canal is still required, but continual monitoring of the flow at the existing check structures on a 24 hour a day basis provides the District with an even better ability to more efficiently manage and conserve the waters of the Solano Project.

DECENTRALIZED CONSTANT-VOLUME CONTROL OF IRRIGATION CANALS

J. Mohan Reddy¹

ABSTRACT

The Saint-Venant equations of open-channel flow were linearized using the Taylor series expansion around an equilibrium condition. A set of linear dynamic equations were obtained for a canal with multiple pools. The principles of optimal control and estimation theory were then applied to derive a decentralized controller and an observer for constant-volume control of irrigation canal pools in the presence of external disturbances acting on the system. Using the linearized Saint-Venant equations and an example problem with 5 pools, the performance of the control algorithm in maintaining a constant-volume in the canal pools was found to be excellent.

INTRODUCTION

The need for real-time monitoring and control of irrigation canal operations is becoming increasingly obvious due to the less than desirable performance of manually controlled large-scale irrigation systems. In addition, the existing rigid schedules do not allow the farmers to tap the full potential of modern irrigation technology at the farm level. Delivery schedules that are more flexible would allow the farmers the needed flexibility to achieve higher efficiencies at the farm level. The flexible delivery schedules, however, make the manual operation of irrigation canals very difficult. To overcome this difficulty, attempts have been made, in the past, to develop local (Buyalski and Serfozo 1979; Zimbelman 1981; Burt 1982; Chevereau et al 1987) and centralized (Rogier et al 1987) control algorithms for demand delivery operation of irrigation canals. However, the derivation of the control algorithms was based upon a tedious trial and error procedure using extensive simulations of the unsteady open-channel flow model.

Optimal control theory provides a well defined methodology to derive gate control algorithms (Corrigan et al 1982; Balogun 1985; Reddy 1990), and eliminates the trial and error procedure that has been used in the

¹ Associate Professor, Department of Civil Engineering, The University of Wyoming, Laramie, WY 82071.

past. Balogun (1985) used optimal control theory for deriving a gate control algorithm for a centralized control system. This procedure, however, handled only initial disturbances without accounting for continuously acting external disturbances (changes in lateral withdrawal rates). Reddy (1990) developed a local control algorithm for controlling individual gates in the presence of both initial and external disturbances acting on the system. However, in the derivation of the control algorithm, the interactions between the pools were neglected. Therefore, there is a need for developing a simple control algorithm for operating a series of gates on an irrigation canal. The objective of this paper is to present a decentralized observer-controller algorithm for demand delivery operation of irrigation canals in the presence of external disturbances.

MATHEMATICAL MODEL

In the operation of irrigation canals, decisions regarding gate openings in response to changes in water withdrawal rates into lateral or branch canals is required to maintain the depth of flow or the volume of water in a given pool at the target value. This problem is similar to the process control problem in which the state of the system is maintained close to the desired value by using real-time feedback control. To apply the linear control theory, the Saint-Venant equations of open-channel flow, which are presented below, were linearized:

$$\frac{\partial y}{\partial t} = -\frac{1}{T} \left(\frac{\partial Q}{\partial x} + w \right) \quad (1)$$

$$\frac{\partial Q}{\partial t} = - \left(\frac{\partial \left(\frac{Q^2}{A} \right)}{\partial x} + gA \left(\frac{\partial y}{\partial x} - S_0 + S_f \right) \right) \quad (2)$$

in which y = depth of flow, m; Q = flow rate, m^3/s ; T = flow top width, m; A = cross-sectional area of flow, m^2 ; S_0 = canal bed slope; S_f = friction slope = $Q|Q|/K^2$; g = acceleration of gravity, m/s^2 ; w = lateral outflow (positive) or inflow (negative), $m^3/s/m$; K = hydraulic conveyance of the channel = $AR^{2/3}/n$; n = Manning friction coefficient; R = hydraulic radius, m; t = time, sec; and x = distance, m.

In Eqs. 1 and 2, the spatial derivatives were replaced by finite-difference approximations, by dividing the pool into few segments (N number of nodes). The forward-, the central-, and the backward-difference schemes were applied to the first, the intermediate, and the last nodes, respectively, of each pool. The turnouts can be located any where in the pool, but the location must be specified for modeling purposes. To solve Eqs. 1 and 2, appropriate boundary conditions at the gates need to be specified. These boundary conditions were expressed in terms of the continuity and the gate discharge equations given by:

Continuity Equation:

$$Q_{i-1,N} = Q_{i,1} = Q_{gi} \quad (3)$$

Gate Discharge Equation:

$$Q_{gi} = C_{di} b_i u_i \sqrt{2g (y_{i-1,N} - y_{i,1})} \quad (4)$$

in which C_{di} = gate discharge coefficient; b_i = width of gate i , m ; u_i = opening of gate i , m ; $y_{i,1}$ = depth of flow at the first node of pool i , m ; $y_{i-1,N}$ = depth of flow at node N of pool $i-1$, m ; $Q_{i,1}$ = flow rate at the upstream end of pool i , m^3/s ; $Q_{i-1,N}$ = flow rate at the downstream end of pool $i-1$, m^3/s ; Q_{gi} = flow rate through upstream gate of pool i , $m^3/s/m$; i = pool index; and j = node index (1 to N). In Eq. 4, the change in bottom elevation of the canal across the gate was assumed negligible.

Lateral Withdrawals

The lateral canals were assumed to be located immediately upstream of the last node in each pool (Figure 1). Though the lateral withdrawal was concentrated at one point, for modeling purposes, it was assumed to be uniformly distributed between the adjacent nodes, and was related to w of Eq. 1 as follows:

$$w = \frac{q_{i,N}}{s} \quad (5)$$

where $s = \Delta x$ in the case of a backward difference scheme, and $s = 2\Delta x$ in a central difference scheme; and $q_{i,N}$ = lateral withdrawal rate at node N of pool i , m^3/s . Similar relationships can be derived for situations where the laterals are located throughout the length of pool.

Linearization of System Equations

The linearized model was derived based upon an initial steady state condition. Using the Taylor series expansion around the initial point and truncating terms higher than the first-order, a set of linear equations was obtained (Balogun 1985). The discrete-time version of these equations for a canal reach with M pools is:

$$\delta \mathbf{x}(k+1) = \Phi \delta \mathbf{x}(k) + \Gamma \delta \mathbf{u}(k) + \Psi \delta \mathbf{q}(k) \quad (6)$$

$$\delta \mathbf{y}(k) = \mathbf{H} \delta \mathbf{x}(k) \quad (7)$$

in which $\delta \mathbf{x}(k)$ = $\ell \times 1$ state vector; $\delta \mathbf{u}(k)$ = $m \times 1$ control vector; Φ = $\ell \times \ell$ system feedback matrix; Γ = $\ell \times m$ control distribution matrix; Ψ = $\ell \times p$ disturbance distribution matrix; $\delta \mathbf{q}(k)$ = $p \times 1$ matrix representing external disturbances (changes in water withdrawal rates) acting on the system; $\delta \mathbf{y}(k)$ = $r \times 1$ vector of outputs (measured variables); \mathbf{H} = $r \times \ell$ output matrix; ℓ = number of dependent variables in the system; m = number of controls (gates); p = number of lateral canals on the supply canal in the given reach; k = sampling instant; and r = number of measured outputs. In Eqs. 6 and 7, the variables $\delta \mathbf{x}$, $\delta \mathbf{u}$, and

$\delta \mathbf{q}$ are defined as follows:

$$\delta \mathbf{x} = (\delta y_{1,1}, \delta y_{1,2}, \delta Q_{1,2}, \dots, \delta y_{M,N-1}, \delta Q_{M,N-1}, \delta y_{M,N})' \quad (8)$$

$$\delta \mathbf{u} = (\delta u_1, \delta u_2, \dots, \delta u_{M+1})' \quad (9)$$

$$\delta \mathbf{q} = (\delta q_{1,1}, \dots, \delta q_{1,N}, \dots, \delta q_{M,N})' \quad (10)$$

in which $\delta Q_{i,j}$ = variation in flow rate at node j of pool i , m^3/s ; $\delta y_{i,j}$ = variation in depth of flow at node j of pool i , m ; δu_i = variation in upstream gate opening of pool i , m ; δu_{i+1} = variation in downstream gate opening of pool i , m ; and $\delta q_{i,j}$ = variation in water withdrawal rate at node j of pool i , $m^3/s/m$. The elements of the matrices Φ , Γ and Ψ depend upon the initial condition.

DESIGN OF CONTROLLER

Equations 6 and 7 can be used to simulate the system dynamics as a function of time, given the initial conditions ($\delta\mathbf{x}(0)$), the external disturbances acting on the system ($\delta\mathbf{q}$), and the gate opening (δu). However, in canal operations the gate opening is the unknown. To achieve a desired system dynamics, given the initial condition and the disturbances (known or unknown), the selection of an appropriate gate opening becomes a trial and error procedure. The concepts of control theory can be applied to eliminate this trial and error procedure, and derive a direct solution for gate opening. To apply control theory, the matrices Φ , Γ , and \mathbf{K} must satisfy the stability, controllability, and observability properties (Kailath 1980). The function of a control algorithm is to bring an initially disturbed system to the desired target value in the presence of external disturbances acting on the system. For this problem, a proportional plus integral (PI) control of the following form was derived using optimal control theory:

$$\delta u(k) = -\mathbf{K} \delta\mathbf{x}(k) \quad (11)$$

where \mathbf{K} = controller gain matrix. A large value of \mathbf{K} requires a high energy input, and might cause overtopping of canal banks. Conversely, if the control is not of sufficient magnitude, the system would return to the target value very slowly, causing large deviations in depths of flow or volume of water stored in the pools. Therefore, there is a trade-off between the rate of return to the equilibrium condition and the overtopping of canal banks. The elements of the controller gain matrix \mathbf{K} are obtained by solving the algebraic matrix Riccati equation, which is a celebrated equation in control theory, and a variety of techniques are available to solve this equation (Kailath 1980). In Eq. 11, once the elements of \mathbf{K} matrix are available, either measured or estimated values of $\delta\mathbf{x}(k)$ are used to calculate the desired variation in the opening of gates. A schematic of a feedback control is presented in Figure 1.

In a centralized control scheme, the control algorithm of each gate (Eq. 11) needs real-time information (flow depths and flow rates at the nodal points) from all the pools in the system. This increases the computational complexity and the amount of data transmission to the central control station. Conversely, in a decentralized control scheme, the control algorithm of each gate requires real-time information from only a few adjacent pools. The decentralized control algorithm presented in this paper (Figure 2) needs information only from the

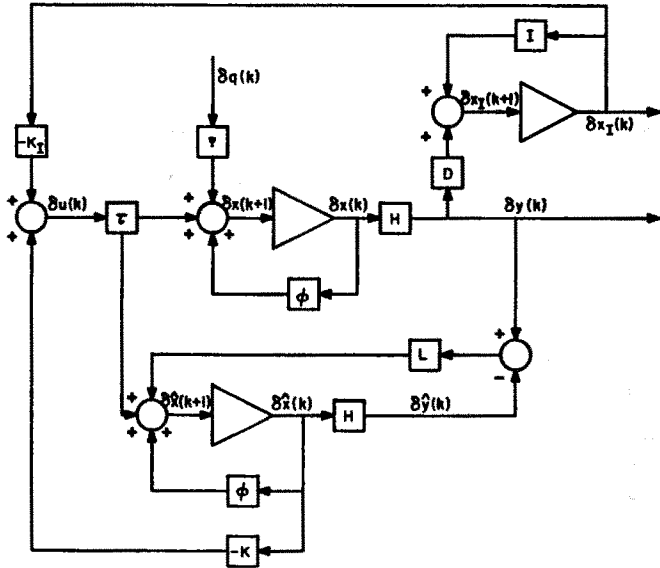

Figure 1. Schematic of a State Feedback Control System

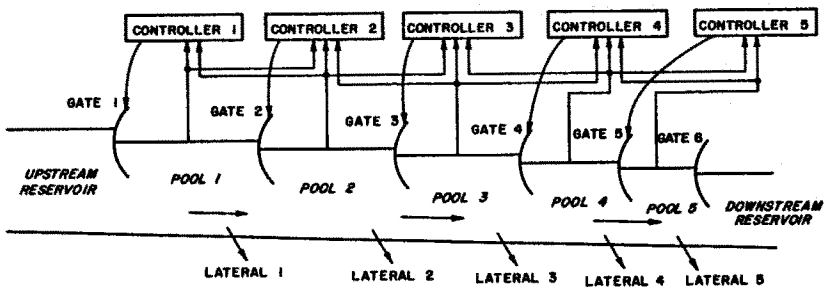

Figure 2. Decentralized Control Scheme

three adjacent pools (one upstream and two downstream pools). This minimizes the amount of data transfer between the pools and the control station(s).

DESIGN OF OBSERVER

In the implementation of the control law defined by Eq. 11, measured values for all the variables- depth and flow rate at all the intermediate nodes of each pool, depth at the first and the last nodes of each pool- must be available for feedback from only the adjacent pools in the case of a decentralized control scheme (Figure 2). This is undesirable from an economic point of view. Since it is very expensive to measure all the state variables, particularly the flow rates, values for some of the state variables must be reconstructed from the available data collected from an irrigation canal. An 'estimator' or 'observer' can be used to minimize the number of measured state variables. An observer is a mathematical model of the given system which predicts values for the state variables that are not measured, based upon measured values of a few state variables (upstream and downstream depths of flow in each pool). Reddy et al (1992) presented a technique for designing an observer for local control systems. The same technique can be extended for the decentralized control scheme presented in this paper. The observer (or estimator) equation is given as follows:

$$\delta \hat{x}(k+1) = \Phi \delta \hat{x}(k) + \Gamma \delta u(k) + L(\delta y(k) - H \delta \hat{x}(k)) \quad (12)$$

in which L = observer gain matrix. In Eq. 12, the estimated values for the state variables are driven by the difference between the measured and estimated values for the selected state variables. Here, it is assumed that only the upstream and downstream depths of flow in each pool are measured. The dimension of the L matrix is equal to the number of state variables estimated including the integral control variables, and the number of measured state variables. Since the observer resides in the computer, in order to keep the on-line computation to a minimum, and to minimize the cost of data communication, a decentralized observer is preferred compared to a global observer. The decentralized observer has a block-diagonal structure. A schematic of a feedback control system with an observer in the loop is presented in Figure 1.

The elements of the observer gain matrix are selected such that the estimated values of the state variables approach the actual values as quickly as possible. This can be done either by using a pole (eigenvalue) placement technique or by designing a Kalman Filter. In this paper, the pole placement technique is used to design the observer. In the presence of random

disturbances, assuming that a model is available to simulate the disturbances, the Kalman Filter is an appropriate choice. The application of Kalman Filter (adaptive type) will be discussed in a subsequent paper.

RESULTS AND DISCUSSION

To demonstrate the applicability of the technique discussed above, an example problem was considered. The data presented in Table 1 were used to derive the elements of Φ , Γ and Ψ matrices, and the initial steady state gate openings (Table 1) for all the 6 gates. The opening of the 6th gate was then fixed at its initial steady state value. The discrete-time matrices were used in deriving the elements of the controller gain matrices for a decentralized control scheme. The performance of the control algorithms were evaluated by introducing known disturbances into the pools (Table 1). In the evaluation, an approximate estimation of the variation in the volume of water stored in the pools was obtained by the following expression:

$$\delta V = \frac{A_{sss}}{4} [0.50\delta y_1 + \delta y_2 + \delta y_3 + \delta y_4 + 0.50\delta y_5]$$

in which A_{sss} = steady state top water surface area (m^2), δV = variation in the volume of water stored in any given pool (m^3); and δy_i = variation in the depth of flow at node i ($i = 1$ to 5), in a given pool. The values of A_{sss} and the initial volumes of water stored in the pools are presented in Table 2.

Disturbances in the form of increased flow rates into all the 5 laterals in the system were introduced (Table 1), and the results of the simulation study are presented in Figure 3. The maximum volume variation of $5400 m^3$ occurred in pool 2, followed by a variation of $4800 m^3$ in pool 3 (Figure 3a). These resulted in 1.38 % and 1.71% of the initial volumes of water stored in pools 2 and 3, respectively, which are not significant variations. After an hour of introduction of the disturbances, the variations in the volume of water stored in the pools bounced back to the initial volumes, and gradually became positive. However, the positive variations in the volume of water stored were smaller than the initial negative variations. These variations in the volume of water stored in the pools were considered to be acceptable.

The variations in gate opening in response to the simultaneous disturbances were also simulated. The maximum steady state variation in the opening was

Table 1. Data used in the simulation study

Parameter	Pool/ gate 1	Pool/ gate 2	Pool/ gate 3	Pool/ gate 4	Pool/ gate 5
Pool:					
length(m)	7000	7000	7000	7000	7000
width (m)	12.25	12.25	12.25	12.25	12.25
bottom	0.0001	0.0001	0.0001	0.0001	0.0001
side slope	1.50	1.50	1.50	1.50	1.50
initial lateral flow rate(m ³ /s)	9.00	6.00	5.00	6.00	5.00
initial downstream depth(m)	4.00	3.40	2.60	2.05	1.66
downstream flow requirement(m ³ /s)	36.00	30.00	25.00	19.00	14.00
Gate:					
width(m)	18.25	18.25	18.25	18.25	18.25
discharge coeff.	0.83	0.83	0.83	0.83	0.83
initial opening(m)	0.32	0.58	0.45	0.48	0.44
Disturbances(m ³ /s)	5.00	6.00	4.00	3.00	3.00
Upstream reservoir elevation (m)				110.10	
Downstream reservoir elevation (m)				99.90	
Upstream invert elevation (m)				102.10	
Downstream invert elevation (m)				98.60	

Table 2. Initial Top Water Surface Area and Volume of Water Stored in Pools

Pool #	Average Top Width (m)	Pool Length (m)	Surface Area (m ²)	Initial Volume (m ³)
1	23.85	7,000	166,950	488,110
2	22.07	7,000	154,497	392,700
3	19.79	7,000	138,548	281,120
4	18.29	7,000	128,044	214,620
5	17.20	7,000	120,365	169,610

0.31 m for gate 2 followed by a variation of 0.20 m for gate 4. The variation in the opening of all the other gates was in the range of 0.15 m to 0.20 m (Figure 3b). These variations in gate opening were considered reasonable.

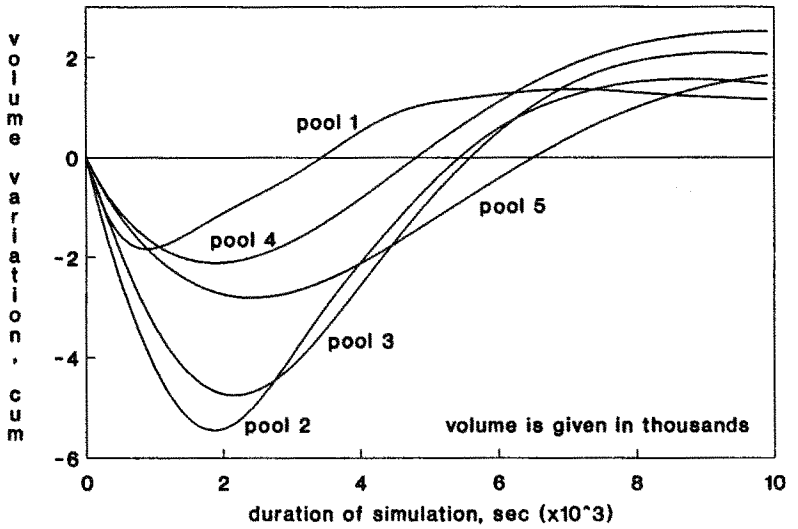

a. Variation in Volumes of Water Stored in Pools

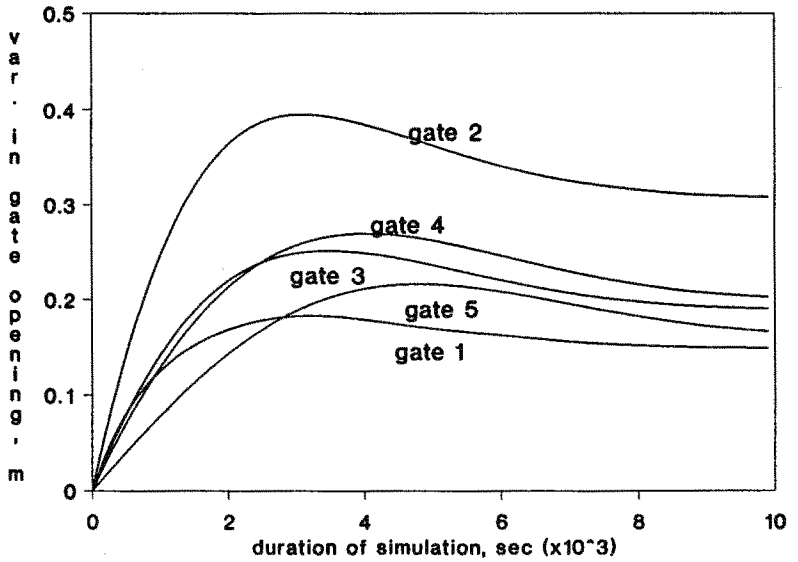

b. Variation in Gate Opening

Figure 3. Canal Response to Disturbances in all Pools

In the above simulations, it was assumed that all the disturbances were positive (increased flow rate into laterals) and started at the same time. Under field conditions, all the disturbances may not be positive and start at the same time. The performance of the system in terms of maintaining a constant volume in the pools would increase when the disturbances acting on the system are temporally distributed, i.e. do not start at the same time. In addition, the performance of the system would be even better in the presence of spatially distributed negative disturbances (either a decreased flow rate into a lateral or a distributed source of inflow into the canal, for example groundwater pumped into the canal) acting on the system.

Figure 4 presents the results obtained using a decentralized estimator in the feedback loop. It is obvious from the Figure that the gate openings calculated using the estimated values approach the calculated gate openings using the measured values of the state variables within 1 hour of the simulation period. This is an acceptable performance of the combined observer-controller algorithm. However, before implementing the algorithm in the field, the performance of the control algorithm must be evaluated using the nonlinear, unsteady open-channel flow model. This will be done in the near future.

An ideal control algorithm is one that would yield a zero percent deviation in the volume of water stored in the pools in the presence of external disturbances acting on the system. But this would result in larger rates of water transfers between the pools, and larger deviations in the depths of flow. In order to minimize the deviations in the depths of flow, some variation in the volume of water stored in the pools must be accepted. The control algorithm presented here strikes a balance between the deviations in the depth of flow and the deviations in the volume of water stored in the pools. In all the simulations, the depth at the middle node of the pools remained more or less constant, and the water surface elevation always pivoted about that point, which is similar to the BIVAL control mechanism (Cheverreau et al 1987). The maximum variation in the depths of flow was at the first and the fifth node in each pool. In this particular example problem, the laterals were located at the downstream end of the pools. Because of the deviations in the depth of flow, the turnouts at the upstream and downstream ends of the pools, if any, must be fitted with discharge regulators to deliver the required flow rate into the laterals under variable head in the supply canal.

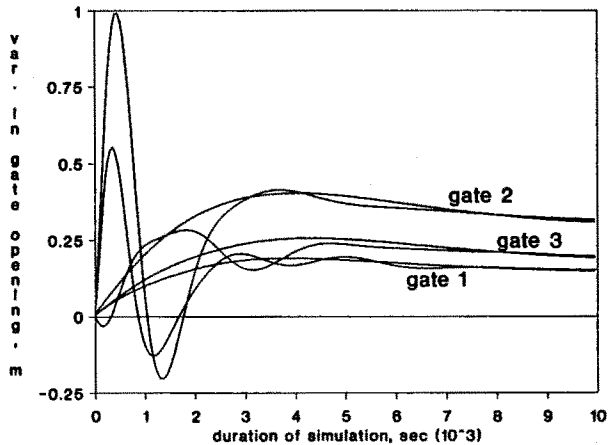

Figure 4. Variations in Gate Opening Using Estimator

SUMMARY AND CONCLUSIONS

Using spatial discretization and the Taylor series expansion, a linear lumped parameter model of open-channel flow was obtained. The canal control problem was formulated as an optimal control problem, and the set of linear equations obtained were used to derive a decentralized control and estimation scheme for operation of a series of irrigation canal gates. For the decentralized control algorithm presented in this paper, the control algorithm of each gate needs information only from three adjacent pools at most. A proportional plus integral control was derived to handle both the initial and the external disturbances acting on the system. A local, decentralized observer was designed to reconstruct most of the state variables of the system, given the measured values of only the upstream and downstream depths in each pool.

To test the performance of the control algorithms, a canal reach with 5 pools was considered. The performance of the control algorithm was evaluated by simulating the dynamics of the system in the presence of several external disturbances in all the 5 pools. The maximum variation in the volume of water stored in the pools was less than 1.6 % when the total magnitude of the disturbances acting on the canal system was $21 \text{ m}^3/\text{s}$. This represented an increase in flow rate of close to 50% of the initial flow rate into the canal. The performance of the decentralized control scheme in terms of maintaining a constant-volume of water in the canal pools was found to be acceptable. Though only 5 pools were used in this paper for evaluating the performance

of the technique, the same methodology can be used to derive control algorithms for irrigation canals that have large (more than 5) number of pools (or gates).

REFERENCES

Balogun, O. 1985. Design of real-time feedback control for canal systems using linear-quadratic regulator theory. Ph.D. thesis, University of California, Davis, California, USA, 262p.

Burt, C. M. 1983. Regulation of sloping canals by automatic downstream control. Ph.D. thesis, Utah State University, Logan, Utah, USA, 171p.

Buyalski, C. P. and E.A. Serfozo. 1979. Electronic filter level offset (EL-FLOW) plus reset equipment for automatic control of canals. REC-ERC-79-3, Engineering Research Center, U.S. Bureau of Reclamation, Denver, Colorado, 86p.

Chevereau, G. and S. Schwartz-Benezeth. 1987. BIVAL systems for downstream control. Proceedings of the ASCE Symposium on Planning, Operation, Rehabilitation and Automation of Irrigation Water Delivery Systems, Portland, Oregon, 381p.

Corriga, G., S. Sanna and G. Usai. 1982. Sub-optimal level-control of open-channels. Proceedings of the International ASME Conference, Paris, France.

Kailath, T. 1980. Linear Systems. Prentice Hall, Englewood Cliffs, New Jersey.

Reddy, J.M. 1990. Local optimal control of irrigation canals. J. of Irrigation and Drainage Engineering, ASCE, 116(5):616-631.

Reddy, J. M., A. Dia and A. Oussou. 1992. Design of control algorithm for operation of irrigation canals. J. of Irrigation and Drainage Engineering, ASCE, 118(6):852-867.

Rogier, D., C. Coeuret and J. Bremond. 1987. Dynamic regulation on the Canal de Provence. Proceedings of the ASCE Symposium on Planning, Operation, Rehabilitation and Automation of Irrigation Water Delivery Systems, Portland, Oregon, 381p.

Zimelman, D.D. 1981. Computerized control of an open-channel water distribution system. Ph.D. thesis, Arizona State University, Tempe, Arizona, USA, 301p.

FIELD MANUFACTURE AND APPLICATION OF REINFORCED
PLASTIC CANAL AND PIPE LININGS

GERALD WESTESEN¹

LEROY PAYNE²

ABSTRACT

Unlined canals and ditches seep, erode, and present management problems. Over time concrete lined canals crack and deteriorate. Pipelines and culverts crack, corrode, leak, and function poorly. A problem solution for unlined canals is to install a reinforced plastic lining which is cheaper, more watertight, and more durable than concrete. For deteriorating concrete canals a reinforced plastic lining can be applied to the existing surface. A reinforced plastic liner can be installed in deteriorating pipelines or culverts. Water control structures can be rehabilitated. These measures can be accomplished with a process and machine which mixes and assembles raw materials (plastic components and reinforcing fabric) at the job site, and applies this composite to the surface of a canal, ditch, pipeline, or structure. As the plastic cures it adheres to the underlying surface and creates a reinforced lining. The plastic used can be formulated to fit the requirements of the particular situation. The lining is durable, water tight, and does not have to be earth covered. The lining can be laid in continuous overlapping strips across large canals, or along the length of small canals. Deteriorating pipelines can be lined using an inflatable bladder surrounded by the plastic composite. This paper explains the process and gives examples of its use.

INTRODUCTION

Excessive seepage and leakage from canals and ditches has always been a problem when conveying irrigation water. Seepage causes a myriad of problems which are not limited to the water lost. These problems include water logged soils, poor drainage, and salinity

¹Professor, Department of Civil and Agricultural Engineering, Montana State University, Bozeman, MT 59717

²Project Director, Innovative Process Corporation, 4643 S. Ulster St. Suite 1520, Denver, CO 80237

buildup. In many areas lands are no longer productive because of these problems and the food supply of entire areas has suffered. Canals and ditches which are not lined support vegetative growth at the water line and underwater areas. This vegetation changes the canal roughness factor, causes an increased depth of flow, and in severe cases restricts water flow completely.

Many types of linings have been tried. Some linings have been successful, while others have failed. Types of linings include concrete, bentonite, and exposed and buried membranes. Concrete is reasonably durable and the technology of formulating, mixing, and placing it is well understood. Concrete is heavy and, if properly placed, smooth. Because of joints and cracking it is not watertight. In areas of freeze and thaw severe heaving and cracking problems can occur.

The use of prefabricated plastic membranes made from polyethylene, polyvinyl chloride, and related formulations has become increasingly common in recent years. These membranes can function well if properly installed but still have some disadvantages. They must be manufactured with factory labor, then transported, and installed. These are all separate operations. When placed the plastic is in a cured state. Thus the plastic does not adhere to the surface on which it is placed. These membranes are formulated as flat sheets. When placed over irregular surfaces they may sustain a puncture immediately or, because of the memory characteristic of plastics, when stretched they will try to return to a flat configuration and eventually puncture. If placed on the soil surface the sheet stock plastics are subject to wind and water movement. An earth cover is often necessary adding to the overall expense. Seaming these sheet stocks can also be difficult and time consuming.

In an effort to overcome these shortcomings of traditional lining materials a new process has been developed, tested, and patented (United States Numbers 4,872,784 4,955,759 4,955,760 5,049,006 5,062,740, other U. S. and foreign patents pending) by the Innovative Process Corp. This process is called the Mobil Reaction Extrusion Process (M-REP). The process can blend chemicals, inert fillers, and fabrics into a site specific lining material, and place the lining where needed.

THE LINING PROCESS

The machinery and mechanisms for conducting the fabrication/lining process can be mounted on a trailer or vehicle. This unit carries drums of raw plastic material, catalysts, filler such as calcium carbonate or recycled plastic, and fabric such as fiberglass or polypropylene cloth. A mixing system allows addition of components such as catalysts, pigments, foaming agents, UV stabilizers, and anti-oxidants. The resulting mixture discharges from a main hose which moves back and forth over the fabric to insure wetting. The "wet" fabric is also pulled through a trough filled with material and between rollers to insure uniform and proper composite thickness.

For lining canals and ditches the fabric is anchored at the beginning of each strip to be lined. This strip can be applied lengthwise on a small ditch or perpendicular and across a large canal. The plastic formulation impregnates and coats the fabric as it unrolls. The resulting composite is laid out as a "wet" blanket on the surface to be lined. This blanket drapes and conforms to the surface. Since thermoset plastics have strong adhesive properties the composite adheres to the surface as it cures. The fabric holds the reacting mixture in place and minimizes flowing during curing. Cure time varies from a few minutes to several hours depending on the type and amount of materials used. Subsequent strips are overlapped thus producing a seamless, watertight surface.

The lining can be applied at a linear rate of about 10 m/min. The area lined will depend on the width of the fabric used and machine capacity. The process is extremely fast compared to alternative lining methods which helps minimize labor costs. The final liner thickness depends on the fabric thickness and the number of layers of fabric used. Typical thickness is approximately 4 mm. Various widths of fabric can be used depending on job requirements. Because this is a "wet" process the lining strips are simply overlapped. No heating or gluing is required to form a seam.

The same machine with minor modifications can be used for lining deteriorating pipes. The key to the process is an inflatable bladder which is placed inside an envelope of fabric. The fabric is impregnated with plastic, then pulled through an existing pipe. The bladder is then inflated forcing the assembly to the shape of the surrounding pipe.

The seam is simply overlapped. Air pressure supplied by a compressor or tank is maintained inside the bladder until the plastic sets. The lining adheres to the existing pipe as with canals and ditches. The resultant structure has the strength of the newly constructed reinforced plastic pipe plus any strength contributed by the existing pipe. After the plastic sets, the bladder can be stripped or left in place depending on the situation.

Lining around structures and the rehabilitation of existing structures can also be accomplished with this process. When lining around structures strips of "wet" composite can be hand placed. These strips are overlapped as necessary. Vertical slopes, which are extremely difficult to rehabilitate with other lining materials, can be readily lined. Lining is accomplished by anchoring the top of the composite with stakes, then draping it down and over the area.

RESINS, FABRICS, AND FILLERS

A very large number of resins, fabrics, catalysts, and fillers can be used in this process. The resins used to date have been primarily urethane elastomers and polyesters. These are thermoset type materials and become solid or semi-solid with the addition of a catalyst. The urethane used results in a plastic which is similar in appearance and feel to automobile tires. Thermoset polyesters are extremely versatile and used in many applications. A few of these applications are boats, recreational vehicles, cultured marble, automobile exterior parts, paneling, bowling balls, and polymer concrete.

The time to initial material set can be changed by varying the type and amount of catalyst used. There are many grades of resins available. The plastics industry has verified material properties and information is available on factors such as strength and elongation in handbooks and texts. The designer can select the resin and catalyst to meet job requirements. Properties such as corrosion resistance are readily achievable with appropriate resin selection.

Fabrics used have included fiberglass, polyester, and polypropylene. The fabric must carry the resin. Too wide a mesh allows the resin to drip off. Too tight a fabric results in poor penetration of the resin. A fabric such as fiberglass can be selected to provide

high strength, and multiple layers of fabric can be used when necessary. If high strength is not required very inexpensive fabrics can be used. The strength and properties of the final product is in the designers hands through resin, fabric, filler, and additive selection.

Filling a resin is analogous to adding gravel to a cement-water mixture when making concrete. By filling the resin, costs can be reduced and properties of the lining can be changed. Filling gives the product greater mass and durability. Fillers which have been successfully used are calcium carbonate dust, shredded tires, and granulated scrap plastic.

This process should provide an ideal way to use recycled plastics. Even the fabric could be a woven mat made from recycled shredded plastic fibers. In agricultural applications the product is used outside, and any odor from recycled plastic should be quickly dissipated. The finished product does not have to be perfect. Seeps finding their way to the natural earth are acceptable as long as they are not severe. Minor imperfections can be patched. This use of recycled plastic is well removed from the end user, which is in complete contrast to using recycled plastic to make bottles, for example.

EXAMPLES OF INSTALLED LININGS

A test program has been underway for three years and a total area of approximately 15,000 m² has been lined. This field testing is in addition to numerous laboratory tests of various formulations to verify properties. Linings have been installed at different and diverse locations which have included ponds, canals, ditches, and water control and conveyance structures. Four sites and installations are described in more detail.

The first site involved a reservoir which had steep side slopes, drop structures between reservoir sections, and water control structures. Lining was placed by using the machine in a normal fashion where possible. This means that as the machine moved forward the fabric impregnated with resin was unrolled and dropped into place. In addition, lining was placed by swinging 30 m lengths of resin impregnated fabric out and over the reservoir bottom with a crane. The lining was placed in over lapping strips so no gluing or sewing of seams was necessary. On the steep

side slopes the strips of fabric were anchored at the top, then draped into place. Vertical slopes were successfully lined. This lining was placed over a wet mud bottom which would have been impossible to work on with any other type material. Strips of lining were hand placed around gates and other water control structures.

The second site involved a concrete lined ditch having a bottom width of 25 cm, a top width of 2.4 m, and 1:1 side slopes. A section of the ditch after lining including a metal turnout is shown in Figure 1. The concrete in this ditch had been badly damaged by cracking and corrosion. In some places short sections of concrete were completely missing. The only preparation for lining was shoveling out some sediment



Fig. 1 Plastic lining of a concrete ditch

deposits on the ditch bottom. A 400 m section of this ditch was lined with a semi-rigid material. The lining was done in a snow storm and was done quickly with the machine moving continuously and parallel to the ditch. The lining has survived one Montana winter and the ditch is being used for irrigation. In areas where the concrete lining had completely fallen away the plastic used had the strength and rigidity to

build a new ditch bank for short distances. Using this process for lining deteriorating concrete linings appears to have great potential.

The third site lined shown in Figure 2 was on an existing section of canal which traversed a shale hillside about 10 m above a farmer's field. Through this section more than 50% of the flow was lost to seepage. The farmer's field was in effect a swamp with a loss of productivity and a threatened law suit. Attempts had been made for years to make this 10 m wide, 450 m long section watertight. The canal was 150 km from any concrete ready mix plant and the job was too small to justify bringing a plant to the site. Thus concrete was economically precluded. Bentonite had been tried unsuccessfully and simply washed through the rock. Sheet stock plastic would have been



Fig. 2 Plastic lining of a rock/earth canal

punctured on the sharp rocks, and soil for covering the sheet stock was not available.

The farmers in the area, with some technical assistance, roughly shaped the canal cross section. Using this process the leaky section was lined in a two hour period. The lining was applied in

overlapping straps perpendicular to the canal. The necessary raw material was transported to the site in a small truck. The lining is functioning, leaks and seepage have been eliminated, and the farmer is happy.

Repairing deteriorating wood or concrete structures can be extremely difficult. This process offers a solution. Figures 3 and 4 show two wood structures which were failing due to age, settlement, and broken

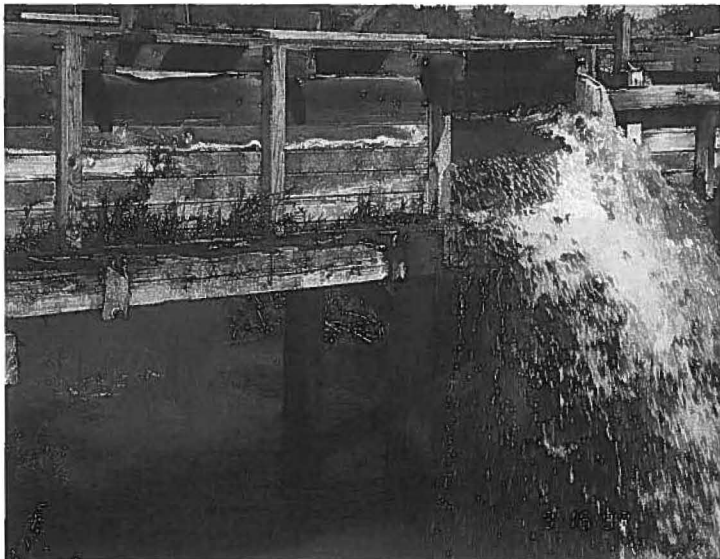

Fig. 3 A deteriorating wood flume

boards. The concrete floors upstream of the flumes was so badly cracked that streams of water were flowing underneath the structures. The structure were draped with a polyester type plastic and fiberglass fabric. A new plastic structure was partially built over the old wood one. The concrete floor was sealed and covered with the same material. The repairs have been successful for one season, and this may provide an expedient way to temporarily or possibly permanently extend the life of this type structure. In Figure 3 and 4 note the plastic lining showing above the wood boards. This plastic lining covered the wood and concrete.

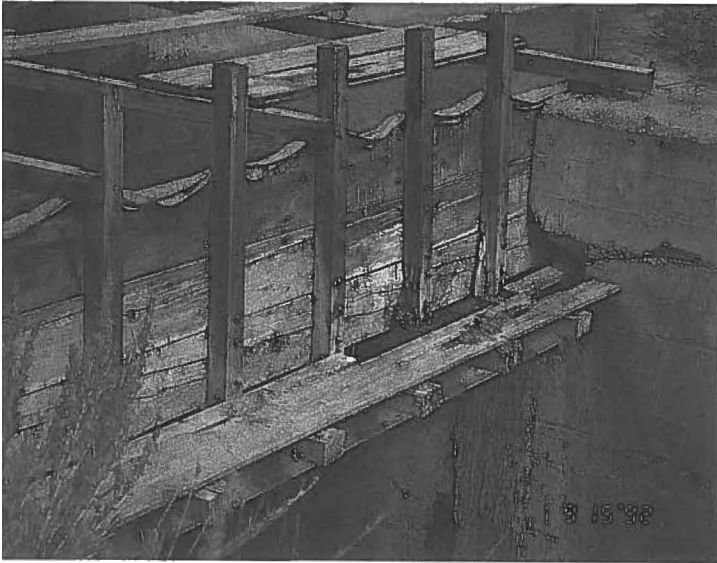

Fig. 4 A wood/concrete structure after repair

PIPE LINING

There are tens of thousands of kilometers of deteriorating concrete irrigation and sewer pipe in the world. There are also countless culverts which carry water through embankments and under roads which are deteriorating and need replacement. This process can be used to seal and rehabilitate existing pipe by, in effect, making a new pipe inside the old one. If the old pipe is structurally sound, only a minimal sealing layer of fibre reinforced plastic may be necessary. If structural strength is needed, it can be provided through specification of the correct resins and layers of fabric. In a similar manner, corrosion resistance can be obtained by specifying particular resin formulations for the layer in contact with liquid.

When rehabilitating culverts the pipe is normally relatively short and open on both ends. The alternative to structurally lining the existing pipe is excavation and installation of a new pipe. This excavation involves more than just digging. Traffic may have to be stopped or detoured with attendant

hazard and liability problems.

SUMMARY

A new process is available to take the factory to the field and to manufacture a multitude of plastic based products. Very logical immediate applications of the process are for the lining of canals and ditches, the lining of existing pipelines, lining around structures, and the rehabilitation of deteriorating structures. The process can utilize recycled plastics for filler or for the fabric. The market potential of the process is huge, and may lead to the creation of a major new industry. Billions of pounds of virgin plastic will be needed, and the process has world wide potential.

RELATED PUBLICATIONS

WESTESEN, G.L., PAYNE, L., RANF, R. 1989. Field fabricated plastic ditch linings. ASAE Paper No. 89-2554, ASAE, St. Joseph, MI 49085.

WESTESEN, G.L., and L. PAYNE. 1990. Field fabricated plastic linings. Proceedings of the IRDC Conference, Irrigation Research and Development in the 90's. Water Research Institute, University of Lethbridge, Lethbridge, Alberta.

WESTESEN, G.L., PAYNE, L., SCHLEGELMILCH, J., EBEL, B. 1991. Pipe rehabilitation with reinforced plastic liners. ASAE Paper No. 91-2036, ASAE, St. Joseph, MI 49085.

WESTESEN, G.L., PAYNE, L., SCHLEGELMILCH, J., EBEL, B. 1991. Field fabrication of reinforced plastic pipes. Irrigation and Drainage Proceedings. IR Div/ASCE. Honolulu, Hawaii.

WESTESEN, G.L., and L. PAYNE. 1991. Simultaneous manufacture and application of reinforced plastic linings. Applied Engineering in Agriculture (Vol.7, No.5, pp.566-568). ASAE, St. Joseph, MI 49085-9659.

WESTESEN, G.L., and L. PAYNE. 1992. On site production of reinforced plastic pipe and other components. The Society of the Plastics Industry, Inc., Western Composites Institute, 7th Technical Conference, Las Vegas, NV.

IMPROVING CHANNEL MAINTENANCE METHODS
FOR EGYPT'S IRRIGATION SYSTEMS

Frederick F. Schantz¹

Robert E. Dixon²

ABSTRACT

AFTER THE CONSTRUCTION OF THE HIGH ASWAN DAM IN EGYPT (1950s), THE CHANNEL MAINTENANCE METHODS ADOPTED BY EGYPT'S DEPARTMENT OF IRRIGATION INCLUDED THE EMPLOYMENT OF HEAVY, INEFFICIENT CONSTRUCTION EQUIPMENT THAT WAS UTILIZED WITHOUT AN EFFECTIVE MAINTENANCE PROGRAM. BY THE 1980s, THESE PRACTICES HAD SERIOUSLY DAMAGED EGYPT'S IRRIGATION AND DRAINAGE CHANNEL PRISMS AND EMBANKMENTS, AND WERE FAILING TO EFFECTIVELY CONTROL THE GROWING POPULATION OF AQUATIC WEEDS.

IN AN EFFORT TO IMPROVE THIS CONDITION, THE CHANNEL MAINTENANCE PROJECT WAS FORMULATED (1986) BY THE EGYPTIAN MINISTRY OF PUBLIC WORKS AND WATER RESOURCES, WITH SUPPORT FROM THE INTERNATIONAL BANK FOR RECONSTRUCTION AND DEVELOPMENT AND THE UNITED STATES AGENCY FOR INTERNATIONAL DEVELOPMENT. THE PROJECT'S PRIMARY OBJECTIVE WAS TO IMPROVE AD HOC CHANNEL MAINTENANCE PRACTICES BY REPLACING THE ESTABLISHED SYSTEM OF CHANNEL EMBANKMENT EXCAVATION WITH AN EFFICIENT PREVENTIVE MAINTENANCE PROGRAM THAT INCLUDED A BALANCED CYCLE OF WEED CONTROL MOWING, HERBICIDE TREATMENT AND DESILTING. A VARIETY OF MODERN CHANNEL MAINTENANCE EQUIPMENT WERE USED, INCLUDING HYDRAULIC EXCAVATOR-MOUNTED SHALLOW-DRAFT BUCKETS AND WEED MOWERS, AND MOTORIZED HERBICIDE SPRAYERS. PROJECT EFFORTS BEGAN IN JUNE 1989 AND ARE PLANNED THROUGHOUT THE 1990s.

INTRODUCTION

Until the late 1950s, when the High Aswan Dam was constructed, maintenance requirements for Egypt's irrigation and channels were minimal. This was mainly due to the presence of silt deposits that were left by periodic flooding of the Nile river.

-
- 1 Principal Engineer, Morrison Knudsen Engineer, San Francisco, California
 - 2 Team Leader, PMP/CMP Projects, Morrison Knudsen Engineers, Cairo, Egypt

The few aquatic weed populations that did appear were easily controlled with manual labor, and earthwork repairs as conditions required. In general, the farming population was able to rely on the fertile silt to revitalize their soil; and farmers unhampered by maintenance problems were able to produce adequate crops.

This condition changed drastically, however, when the high dam was constructed. The presence of the dam greatly reduced sediment deposited downstream and allowed a dramatic increase in aquatic weed growth due to the presence of clearer water which allowed more sunlight penetration onto the channel beds. The addition of agricultural fertilizers in the drainage water and perennial use of the channels has also encouraged weed growth, which continues to spread to all of Egypt's waterways.

THE CHANNEL MAINTENANCE PROJECT

In an attempt to reduce the damage being done to channels from over-excavation with heavy equipment, and to effectively control the aquatic weeds, during 1986-89, Egypt's Ministry of Public Works and Water Resources (MPWWR) requested the International Bank for Reconstruction and Development (IBRD), and the United States Agency for International Development (USAID) to assist in resolving their serious channel maintenance problems. Both the IBRD and USAID responded with funding and technical assistance and the multimillion dollar support effort for a Channel Maintenance Project (CMP).

Objective:

The objective of the CMP was to improve channel maintenance activities in the Irrigation Sector while reducing operational costs. The project was workcharged with introducing modern channel maintenance practices, replacing the traditional system of excavation with a balanced cycle of weed mowing, herbicide treatment and desilting.

The 8-year project, planned in 1986, began implementation in June, 1989. During the project, the equipment fleet of the channel maintenance contractors, including, for the first time, private sector companies, was upgraded. The new effort was to focus on cycle-based maintenance schedules, which

would be introduced over the entire 48,000 kilometers (28,800 miles) network of public channels. Technical assistance (TA) was therefore provided to the irrigation sector, the Weed Research Institute (WRI), and to the Public Sector Excavation Companies (PECs) to improve management, planning and monitoring, together with specialist support on specific technical issues. Special attention was given to improving the control in the use of chemicals. The results expected were improved maintenance performance at lower costs.

Replacing Old Methods with New Technologies

The CMP efforts began by supplementing or replacing old, inefficient channel maintenance practices with new, modernized ones. While manual labor employment was, and still is, used in areas inaccessible to modern equipment, the PECs's application of large dragline excavators as the primary means for channel bed desilting and weed removal was the initial area of concern. The practice of removing large amounts of soil, using deep draft toothed buckets, was noticeably over-excavating channel prisms and working at a high rate of cost to remove aquatic weeds.

A strategy was therefore developed to reduce dragline use and implement the project's objectives. The initial plan was to maintain the channels and control weeds through an integration of modern maintenance methods (Table 1). Use of these methods in a cyclical pattern would effectively control all submersed, emersed, ditchbank, and floating aquatic weeds growing at an increasing rate in all parts of Egypt's irrigated lands. As the CMP effort was to be focused on the use of mechanical equipment, a large amount was ordered, delivered to the field sites, and commissioned.

To ensure that the modern equipment employed would be effectively utilized, three computerized management systems, including the Maintenance Operations Management System (MOMS), the Equipment Management System (EMS), and the Materials Management System (MMS) were developed as part of the initial project effort. The use of the data from these systems provided irrigation system maintenance operation managers with accurate, current information from which periodic plans have been made.

 Table 1: Modern Methods of Channel Maintenance

SUBMERGED WEEDS	- Excavation with shallow-draft, toothless buckets
	- Herbicide injection into channels
	- Harvesting with weed harvesters
	- Mowing with weed-mowing buckets
	- Mowing with weed boats
	- Cabling and drag chaining
EMERSED/ DITCHBANK WEEDS	- Mowing/mulching with mowers
	- Excavation with shallow-draft, toothless buckets
	- Spraying with herbicides
	- Scraping with sloper blades
FLOATING MARINE WEEDS	- Spraying with herbicides
	- Excavation with shallow-draft, toothless buckets
	- Harvesting with weed harvesters

Herbicide Ban

After the PM program had been developed and the implementation effort had begun, for a number of reasons beyond the scope of this paper, in January 1991 the GOE banned the use of herbicides in Egypt's channels and drains. The project subsequently discontinued its plan to use herbicides and in their place added a wider range of mechanical equipment and a biological control method (weed-eating grass carp). While the MPWWR realized that more equipment meant increased maintenance costs and the introduction of fish a change of focus, the changes had to be effected in order to combat the ever-increasing aquatic weed growth. From 1991 until the present time (December 1992), a revised program has been used, utilizing grass carp and the following additional equipment.

- Slopers blades mounted on motorgraders
- Weed mowing boats
- Amphibious weed harvesters

In order to provide adequate technical reference material to the MPWWR personnel working with the new technologies, the technical assistance team also developed a Weed Control Manual for the Channels and

Drains of Egypt and an Irrigation and Drainage Systems Maintenance Manual. These manuals are serving as guidelines for effective channel maintenance, both in planning maintenance activities and completing maintenance tasks.

Current Channel Maintenance Practices

The practices developed by the CMP (which is still continuing in 1992), has resulted in the following methods of channel and drain maintenance.

MANUAL CONTROL

The age-old method using manual labor is still a significant part of the weed control effort. But while at least 55 % of all weeds are normally controlled by this method due to increasing labor costs and decreasing labor supply when needed, this control is on the decline. The risk of becoming infected with bilharzia disease from wading in water infested with parasites is a great detriment to the use of this effort. Also, the MPWWR does not recognize this method of control as an effective way to do channel maintenance.

MECHANICAL CONTROL

Completing channel maintenance, especially weed control, with mechanical equipment is the most popular method used in Egypt. The modern equipment used is as follows:

Shallow-draft. Toothless and Perforated Excavation Buckets

The most effective mechanical equipment used to date are the shallow-draft buckets that are used to control submersed aquatic weeds. Excavation is kept to a minimum, usually once during the weed-growth season (March-May), since this is the most effective time to remove the accumulated biomass. Like ditchbank weeds, emersed weeds should also be excavated before they set seed.

Floating weeds (waterhyacinth) are also removed with shallow-draft buckets, clearing the channels and drains for desilting and/or eradication of submersed weeds.

These buckets may be used for excavation of emerged and ditchbank aquatic weeds before seed set to avoid their spread. Only one shallow excavation should be made per year for weed and/or silt removal.

Flail Mowers - for Ditchbank Weeds. Flail mowers are used each weed growing season to cut down and shred ditchbank weeds. Mowing is normally performed early enough in the weed growing season (March-May) before target weeds set seed to avoid spreading undesirable weed seeds. Flail mowing of regrowth eliminates the need for mechanical excavation of ditchbanks to control ditchbank weeds.

Mowing Buckets

The mowing bucket is an open skimming shaped bucket with a sickle-type cutter on the cutting edge. This bucket mows the weeds and at the same time is able to gather the cut weeds. The mowing bucket is effective in mowing underwater grasses but inefficient in mowing heavy, coarse weeds.

Drag Cables or Chains

A cable or chain suspended across a channel and dragged upstream by two tractors is an effective method to control high density weeds. This operation can be inefficient when it drags or up-roots submersed weeds which are allowed to flow free and/or entangle on the drag cable or chain and pilon control structures.

Embankment Reshaping Using a Sloper Blade

Reshaping or restoring a channel bank to design specifications, using a sloper blade mounted on a motorgrader can facilitate a weed mowing program. Also, a channel bank can be maintained and be weed free by employing a sloper blade to scrape the side slopes clean of weed growth.

Mechanical Weed Harvesters

Controlling aquatic weeds with mechanical weed harvesters is usually ineffective and expensive, although occasionally successful in carefully selected channels. Some units are being effectively employed for skimming floating weeds; others have been successfully

used for harvesting deep-growing submersed weeds located on a flat-bottomed channel bed.

Weed-Mowing Boats

Weed-mowing boats with vertically and horizontally-mounted cycle bars are effective in selected areas. The high maintenance and cost to operate the units makes them uneconomical to use.

BIOLOGICAL CONTROL METHODS

The White Amur fish (grass carp) bred at the WRI's delta barrage fishery, has become effective in the control of some aquatic weeds, although most fish are fished out of the channels soon after being planted in them. Grass Carp have been successfully stocked in some larger channels, such as in the Suez area, and with effective control, have successfully controlled aquatic weeds.

CURRENT STATUS

As of December 1992, the status of the CMP is as follows:

1. The MPWWR's plan of integrated maintenance practices and techniques have been revised. New equipment has been procured to replace old units.
2. Additional modern channel maintenance equipment has been added to project areas.
3. A modern PM program, contained in two manuals that include CM maintenance cycles, has been developed and is being implemented in Egypt's irrigation directorates.
4. CM personnel have been trained on modern maintenance methodologies.
5. CM equipment repair shops have been established and equipped with modern tools to maintain CM equipment.

SUMMARY AND CONCLUSIONS

In summary, the CMP effort has begun to be successful in improving the traditional maintenance practices that have formerly resulted in channel deterioration. The employment of appropriate mechanical and effective biological maintenance methods in place of dragline excavators have begun to control the vast and heretofore uncontrolled weed populations growing throughout the country. The abrupt moratorium on herbicide use has and will continue to detract from the success of the project, but to what extent remains to be seen.

Realizing the need for additional funding and resources, the European Economic Community (EEC) has recently (May 1993) shown an interest in adding their support to the CM effort. This aid is planned to begin in May 1993 when the current USAID technical assistance contract is due to expire. A definitional mission was completed in May 1992 by EEC consultants and discussions are currently being held to determine the future involvement of the IBRD, USAID and EEC.

In conclusion, if MPWWR personnel managing the CM effort effectively and efficiently utilize the modern equipment, biological maintenance method, and other updated knowledge and skills provided by the project, emergency situations will be prevented and the channel maintenance effort successful.

REFERENCES

1. FAO. March 1985. "Egypt Channel Maintenance Plan: Identification Report: 31/85 CP-EGY 33". FAO, Rome, Italy.
2. Khan, A.N. and G.E.S. Mahmoud. May 1992. "Aide Memoire: Arab Republic of Egypt Channel Maintenance Project (Loan 2732-EGT) in Depth Review--Reconstructing Mission, April 21-May 8, 1992. World Bank. Cairo, Egypt.
3. MPWWR/MKE. June 1992. "Preventive Maintenance/Channel Maintenance Project Annual Workplan. PMP/PMP, Cairo, Egypt.
4. MPWWR/MKE. August 1991. "Weed Control Manual for the Irrigation and Drainage Channels of Egypt", MKCorp, Boise, Idaho.
5. MPWWR/MKCorp. February 1992. "Strategy Paper for Channel Maintenance for the Nile River and Channels of the Irrigation Sector". MPWWR, Cairo, Egypt.
6. MPWWR/MKE. 1989. "Life of Project (LOP) Plan for Preventive Maintenance Project (PMP) and Channel Maintenance Project (CMP). MPWWR. Cairo, Egypt.
7. Schantz, F. F., et. al. June 1992. "A Preventive Maintenance Approach to Irrigation System Management in Egypt" (unpublished). ASAE, St. Joseph, Michigan.
8. USAID. September 1987. "Project Paper: Irrigation Management Systems Project 2630132", USAID, Cairo, Egypt.
9. World Bank. May 1986. "Arabic Republic of Egypt Channel Maintenance Project: Staff Appraisal Report No. 6044-EGT". World Bank, Cairo, Egypt.

ROUTING FLOOD WATER THROUGH AN IRRIGATION DELIVERY SYSTEM

W. Martin Roche¹

ABSTRACT

The Turlock Irrigation District, located in the Central Valley of California, supplies irrigation water to 150,000 acres and electricity to over 60,000 customers. The District's irrigation service area is highly developed, and most natural drainage channels have been eliminated. The irrigation delivery system, consisting of 250 miles of canals and laterals, is used by farmers and cities to route storm drainage during the wet season. There are two small intermittent streams, Sand Creek and Mustang Creek, that enter the canal system. During normal storm events, runoff is small and the canals can readily handle the flows from the two creeks, and storm water from Turlock, other communities, and farms.

On February 12, 1992 an intense storm in the area resulted in rainfall accumulations of 2.5 inches to 3.5 inches in a 24-hour period. Rainfall of these intensities occurs less frequently than once every 100 years. By early afternoon it was obvious that large flows from the two streams would reach the canal system by evening. A command post was established and crews were organized to patrol the canals and to route flows to laterals with capacity available. In the early evening the Highline Canal had broken in five locations. Crews were immediately dispatched to begin repairs, and additional help was secured from local contractors and farmers.

During the same period, the Turlock Main Canal was flowing at peak capacity, with flows being routed to several laterals. The City of Turlock had to discontinue pumping for almost 24 hours. By carefully routing the storm water and keeping the canals and laterals free of debris, additional major damage was avoided. As a result of this emergency, the Turlock Irrigation District is preparing a flood control manual for use in future flood events.

INTRODUCTION

The Turlock Irrigation District is located in central California between Sacramento and Fresno and provides irrigation water to 150,000 acres of

¹ Construction and Maintenance Department Manager, Turlock Irrigation District, Turlock, California

agricultural land that produces milk, poultry, beef cattle, almonds, grapes, melons and other crops (Fig. 1). Most of the District's water is stored in Don Pedro Reservoir on the Tuolumne River. The Modesto Irrigation District and the City and County of San Francisco also get their water supplies from the Tuolumne River. The Turlock Irrigation District was formed in 1887 and as the oldest irrigation district in California, it is one of only three that also provide electricity to retail customers. There are over 60,000 electric customers in a 425-square mile area. The District operates a 203-MW hydroelectric plant at Don Pedro Dam, several other smaller hydroelectric plants, and a gas turbine plant that provide up to 45% of the District's power needs in normal water years. The area has just experience its sixth consecutive drought year as shown in Table 1.

Table 1. Rainfall and Runoff for Tuolumne River Watershed

Water Years	1986 1987	1987 1988	1988 1989	1989 1990	1990 1991	1991 1992
% of normal precipitation	53.6	63.9	74.4	76.1	71.2	71.0
% of normal runoff	34.8	43.6	69.7	44.9	58.4	44.6

Normal precipitation is 36.05 inches, normal runoff is 1,882,000 acre feet.

While the drought continued in the watershed, precipitation in the Turlock area was 11.39 inches in 1991-1992, exceeding the normal precipitation of 10.79 inches. The storm of February 12, 1992, which caused considerable local flooding, therefore did little to break the six-year drought.

GENERAL FLOOD OPERATIONS

The Turlock Irrigation District operates and maintains about 250 miles of main canals and laterals throughout its service area (Fig. 2). The land is very flat, land systems have been graded to minimize tailwater, and natural drainage channels in the area have been eliminated. The canals and laterals serve as the storm drainage systems, with cities special districts, counties, and farms discharging flood water into the system. There are two small streams entering from the east. Sand Creek has a drainage area of 18.4 square miles and enters the Turlock Main Canal. There is no storage except for ponding above the siphon where it flows under the Highline Canal. Mustang Creek has a drainage area of 22.7 square miles and enters the Highline Canal. There are two small flood control basins on Mustang

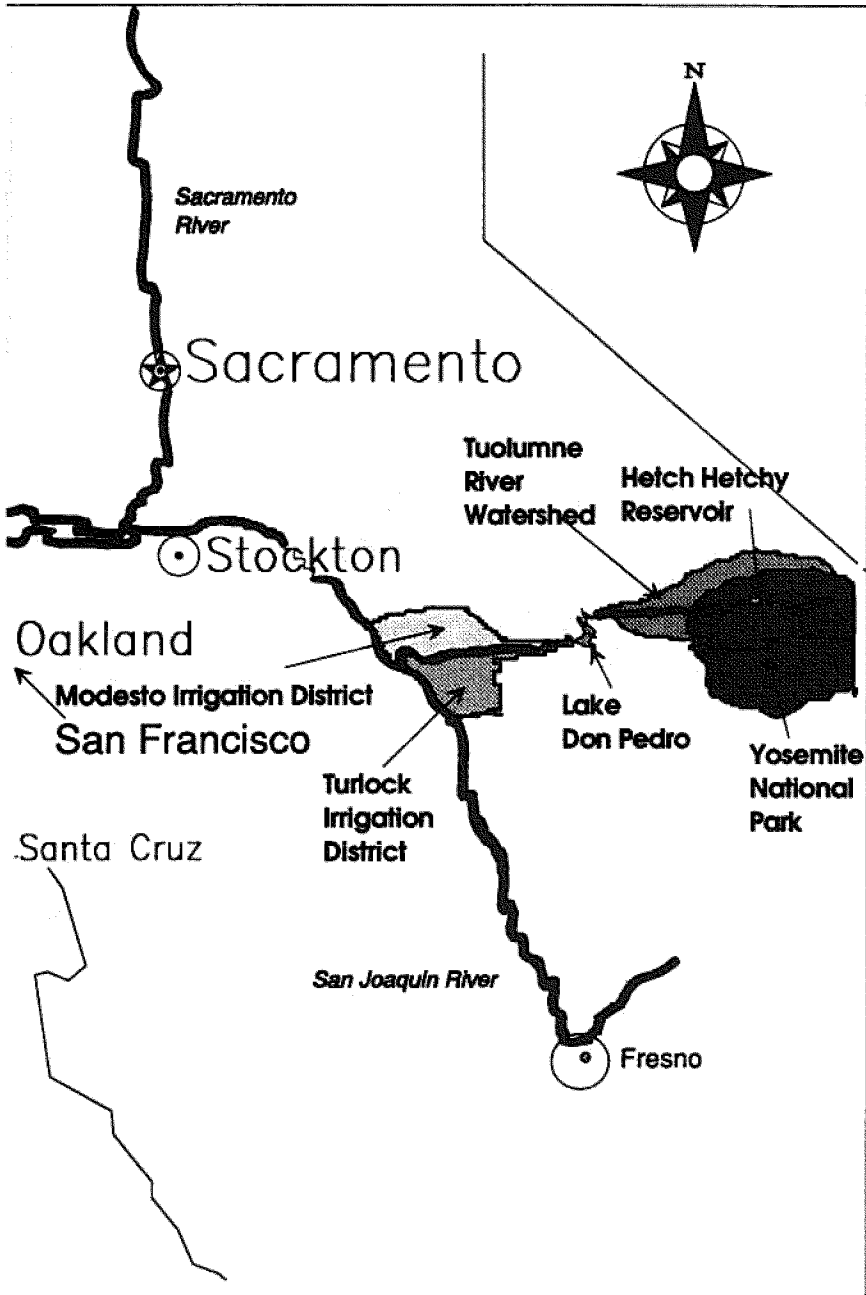

Fig. 1 General Location Map

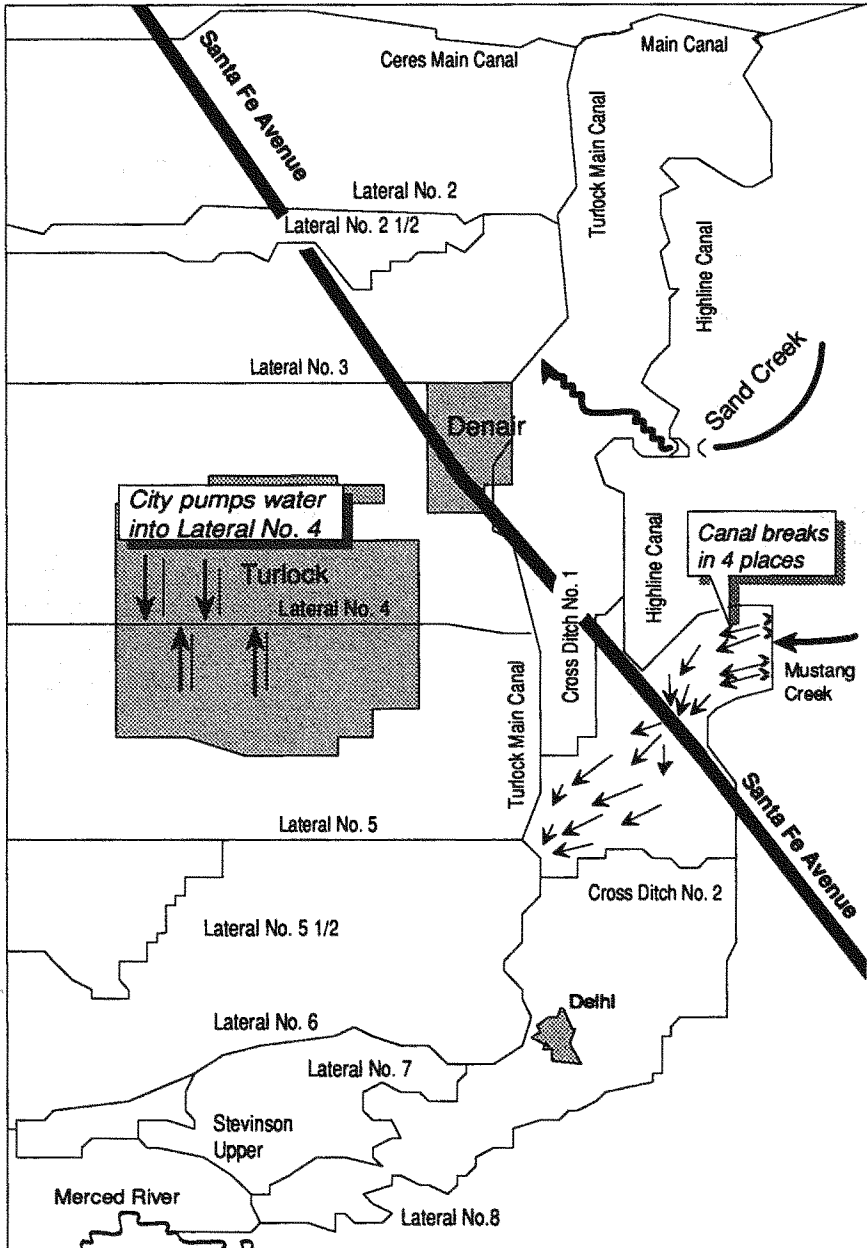

Fig. 2 Turlock Irrigation District Flood Area

Creek, with a combined storage of about 600 acre-feet. Capacities of the canals range from 30 to 2200 cubic feet per second (cfs), and the District has storm water pumping agreements with the cities and others who discharge into the system. These agreements take into consideration the capacity of the system and other flows which must be accommodated. The canal system is designed to deliver irrigation water and not to pass flood flows, with canal capacities decreasing as they go downstream. In some cases storm water can be discharged from the canals into community and private ditches, and directly onto farm land. Each fall after the irrigation season has ended, canal structures are cleaned, repaired, and set to route storm water through the system. Major repairs and system improvements are scheduled to least interfere with flood operations. When major storms occur, the system is patrolled as needed to keep structures and grates clean of debris, to monitor flow, and to route flood water through the system.

FEBRUARY 12, 1992 STORM

The storm of February 12, 1992 brought from 2.5 inches to 3.5 inches of rain to the District in a 24 hour period. The Sand Creek and Mustang Creek drainage areas to the east of the District received the most rain, with up to 3.8 inches for the day and 5.25 inches for the week being reported. The 50 year, 24 hour storm for the area is 2.50 inches, the 100 year, 24 hour storm is 2.74 inches. Further to the east, in the Sierra-Nevada foothills, rainfall was much less, and the mountain areas received only a moderate amount of snow. The storm caused flooding and damage throughout Stanislaus and Merced Counties, and flooding also occurred in southern California during the same time period.

DISTRICT RESPONSE

During the morning of February 12, 1992 there was localized urban flooding throughout Turlock, including the District's Corporation Yard. It soon became apparent that a major storm event had occurred, and that preparations were needed to route significant flood flows through the District's canal and lateral system. A command post was established and field crews were organized and scheduled to patrol the system throughout the afternoon and night. Technicians were also dispatched to obtain flow data on the streams entering the system and at key points on the canals and laterals.

Highline Canal Breaks

About 7:00 p.m., a two-man crew was working its way up the Highline Canal, cleaning debris from drop structures and grates. The canal had been running at near capacity, 600 cfs in this area, when the crew noticed a significant decrease in flow. They continued to drive upstream and came to two breaks in the canal above Santa Fe Avenue and below the point where Mustang Creek enters the canal. At about the same time another crew was working its way down the Highline Canal and discovered two other breaks in the canal above Mustang Creek. Both crews reported the breaks to the command post about 7:30 p.m. By 8:00 p.m. two additional managers had come in to assist at the command post, and one immediately left for the Highline Canal to observe the breaks and make plans for repairs. District employees were called to form a repair crew, and arrangements were made with nearby farmers to excavate and haul earth from their land to repair the breaks. Contractors were also called during the night and were on the job by early morning to haul earth and rock. The major breaks were closed by the afternoon of February 13, and other repairs were completed by the next day.

Canal capacity is 500 cfs above Mustang Creek and 600 cfs below Mustang Creek. Peak Flows which caused the breaks were estimated at 630 cfs in the Canal above Mustang Creek, with an additional 300 cfs entering the Canal from Mustang Creek.

Turlock Main Canal Operations

The Turlock Main Canal takes storm water primarily from Sand Creek (Figure 2), and the water is routed to Laterals 3, 4, 5, 5½, 6 and 7 where it is then discharged to the San Joaquin River. Some farms also can pump into the system, and the City of Turlock pumps into Lateral. By the evening of February 12 the Turlock Main Canal and the laterals were flowing at near their peak capacity of 585 cfs, and by 9:00 p.m. we required the City of Turlock to discontinue pumping. By noon on February 13 the flows had begun to recede and by 6:00 p.m. we were able to stop diverting flows to Lateral 4, and the City was able to resume pumping to drain flood basins and city streets.

The crews that patrolled the system were able to turn off many of the pumps draining farm land, and in other cases found farmers who were willing to flood their land with storm water from the canals and laterals.

n area of particular concern was the head of Lateral 6, where flood water from the Highline Canal breaks would reenter the system. Due to the topography of the area, this water did not reach Lateral 6 until about 8 .m. on February 13, well after the peak flows on the Turlock Main system had passed. The rate of flow reentering the system was only about 20 cfs.

Another area of concern was where Lateral 5 crosses Highway 99. The rate at that location plugged repeatedly with tumbleweeds and other debris, and a crew had to be stationed there continuously during the peak flow period.

Actions After the Flood

Once the peak flows had past and no new major storms were predicted, Turlock Irrigation District managers, engineers, technicians and key field people met several times to assess the storm event, the resulting flooding, and the District's response. Actions from those meetings included the following:

1. Gathering and organizing of all available rainfall and flow data.
2. Debriefing of all field personnel and others who responded to the flood.
3. Development of a plan for continued minor repair of the system, and improvements to markings of floodgates and flow measurement stations.
4. Development of long range plans to line additional reaches of the Highline Canal.
5. The cost of the flood to the District was estimated at \$37,000 for overtime and for materials and contracts for repairs.
6. Plans to write a flood control manual to ensure that our response to future flood situations is timely and appropriate. The major items to be included in the manual are:
 - a. End of season setup for the canals and laterals.

- b. Emergency response planning, to include crew-call out lists, rental equipment lists, repair material locations, emergency purchase order procedures, and command post arrangements.
- c. Storm water routing planning, to include canal capacity maps, storm weather watch, routing of storm water, command post activation, and canal system monitoring
- d. Damage assessment and debriefing.

CONCLUSION

In conclusion, an extraordinarily intense local storm took place in the Turlock, California area on February 12, 1992, in the middle of a string of severe winter storms. These storms caused flooding and damage in several areas of Stanislaus and Merced Counties. Water flowed from the hills to the east of the Turlock Irrigation District down into the Highline and Turlock Main Canals from a storm which deluged the area with several inches of rain in a short period of time.

The storm water caused breaches in the Highline Canal in many places both by breaks and by topping over. Much of the District's canal system filled to capacity because of the unusual storm. Without the canals and the storm water storage system on Mustang Creek the flooding probably would have been much worse and more widespread. The canal system and District crews functioned very appropriately and only the large amount of water in a relatively short period of time could account for the flooding that took place.

EXPERIENCE WITH FLEXIBLE SCHEDULES AND AUTOMATION ON PILOT PROJECTS

John L. Merriam¹

ABSTRACT

Worldwide the on-farm water management restraints created by rigid water supply schedules cause problems of inefficient irrigation and rainfall use, high water tables, lowered production, increased and less convenient labor, complicated cultural operations, and increased costs. In the USA a beginning is just being made to modify the fixed flow rate/24 hour duration schedule to permit farmers to adjust the flow rate and duration. In developing countries frequency as well as rate and duration are usually fixed with rotation schedules. Because of the small farm sizes durations of the fixed stream vary in proportion to the farm area and not the soil intake rate nor antecedent rainfall. The rotation stream is delivered at inconvenient times and the flow rates are rigid and usually too small for practical management and for labor efficiency. High water tables correlate with inefficient irrigation.

Pilot Projects designed with: adequate short-term storage to accommodate large variations in flow rate which are often greatly reduced at night; with automated canals and pipelines capable of responding to downstream farmer initiated flow variations; and with large variable streams to greatly reduce irrigation time and labor, can be used to demonstrate the value of flexible arranged or demand schedules having only economically non-restricting controls on frequency, rate, and duration.

INTRODUCTION

A small but enlarging program has been carried on for a number of years to educate engineers, farmers, government officials, policy setters, and others of the necessity of having a flexible water supply delivery schedule at the farm level. Pilot projects have been used to assist this program. Much research and development work has been done in improving on-farm irrigation equipment: sprinkler, trickle emitter,

¹Professor Emeritus, Irrigation Training and Research Center, Agricultural Engineering Department, California Polytechnic State University, 235 Chaplin Lane, San Luis Obispo, CA 93405

surge flow, etc. Much has been done to improve scheduling of water application and refining techniques for determining the evapo-transpiration or soil moisture deficiency. Procedures to determine irrigation efficiency and uniformity are beginning to be applied on the farm.

A common factor for all of this research is that it is developed with the intent of improving water use, or of making something that can be sold that will save water or labor. It is presumed that the farmer will utilize the information or equipment. In practice this use happens only under unusual conditions with center pivot sprinklers and trickle being major exception to a large extent because something is for sale as well as being practical. It is a common comment by technical people that the farmers just don't do a good job -- if it is good enough for grandfather, it is good enough for me. The real condition however, is that generally they cannot do it even when they are aware of improved procedure. This is true because almost all of these refined techniques involve a modification of the frequency, rate, or duration of flow, a condition which frequently can not be attained because of restrictive schedules.

The scheduling restraints put on the manageability of the applied water have been accepted, but not adequately realized nor challenged. Until the farmer can control the frequency, rate and duration of the water supply, he cannot be an effective manager. A well designed sprinkler system that applies a designed depth in a set time convenient for labor, e.g. 12 hrs., can seldom match a desired depth unless frequency is a variable during the season. Or if frequency is set because of farming operations, it can seldom match the desired condition unless duration is a variable. Or changing root zone depth needs cannot be matched unless duration and frequency are variables. For surface irrigation the changing intake rates during the season and different application depths require that duration be a variable, and that the flow rate be a variable to match a desired set size. For developing countries with rotation schedules, it is not realized that it is impossible for a farmer to be more efficient than the design value with its fixed assumptions since the water supplied is fixed. If the farmer wished to improve his efficiency, water could not be saved unless he could take less which he cannot do unless he is given control of the supply.

Only by educating the farmers which they desire to have done, and giving them control of the frequency, rate, and duration can effectiveness of irrigation be upgraded. Improved labor has the same relationship to upgraded scheduling, it cannot be made better without schedule changes. It is especially important to have a large stream to

shorten labor and have variable convenient durations to avoid most night irrigation and conform to available labor.

The 24 hour duration arranged schedule prevalent in the USA, puts appreciable restraint on the irrigation manager which is accepted because it is not realized that it can be modified in a practical and economical way. Though he may arrange the frequency and stream size on many projects, the fixed duration relates to a specific stream size so that the delivered depth reasonably matches the soil moisture deficiency condition and irrigation efficiency. The resulting stream size seldom is the best for the set size. To have the set durations which should be related to intake rates always equal a 24 hour unit is improbable. The compromise with convenient labor and the water supply is lower irrigation efficiency with non-uniform infiltration and runoff. Set durations of 8 or 12 hours for convenience of labor dominate rather than durations related to intake rate and soil moisture deficiency which do not correlate with 24 hr increments and specific frequencies so efficiency suffers.

It must be realized that until the manager can control the irrigation frequency, rate and duration, he cannot optimize his management program. He cannot make irrigation a coordinated aspect of the total farm program of cultural operation, irrigation method, crop production, water use efficiency, labor amount and convenience. Until the frequency can be set to match the desired management allowed soil moisture deficiency or the convenience of labor relative to the total farming operation, production or expenses must be compromised. Until rate can be controlled to optimize set size, match intake rates, utilize labor fully, conform to desired method needs, control efficiency, reduce runoff or deep percolation, etc. operation costs will be excessive. Until duration can be controlled to turn off the water when enough has infiltrated, water will be wasted and a high water table may be created. Restraints on the schedule impact management capabilities. The alleviation of scheduling restraints must become a major objective of those associated with new irrigation projects or the rehabilitation and upgrading of old ones. Adequate knowledge and experience exists to incorporate the needed changes even though it is not widely known. Pilot projects may be needed to provide local experience but they should not be used as an excuse to delay the implementation of current information.

One of the long term objectives of the On-Farm Irrigation Committee of the ASCE is: Bring awareness of the on-farm irrigation needs to the larger civil engineering profession who do designs of irrigation projects

in a conventional way without adequate knowledge of on-farm conditions.

SCHEDULES

Schedules of water delivery are the expression of how water is made available to farmers. Restraining, rigid schedules restrict farm management capability. The rotation schedule rigid in all aspects of frequency, rate, and duration is common in many developing countries. It forces inefficient water and labor use and restrains production. The common schedule in the USA is the 24 hour duration limited rate arranged schedule. It appreciably restricts labor and water use efficiency and not infrequently limits crop production. It is an accepted schedule and its restraints are not often realized and challenged. However in some areas such as Coachella Valley, many farmers have installed reservoirs for 40 and 80 acre (16 and 32 ha) units to facilitate labor and management operations more than for water conservation. By so doing they can convert the small stream, 24 hour supply schedule to a demand schedule with a large flow rate, often four times larger than the supply rate, with a corresponding reduction in irrigation labor time and an increase in irrigation efficiency.

The broad classifications of schedules as listed by the On-Farm Committee of the ASCE (ASCE 1984) and in the ASCE Symposium Proceedings "Planning, Operation, Rehabilitation and Automation of Irrigation Water Delivery Systems" (ASCE 1987) are: Rotation with preset conditions of frequency, flow rate, and duration; the Arranged modifiable between the rigid and flexible arranged schedules and which requires a communication system between the supplier and the farmer to arrange the restraints; and the Demand schedule in which the farmer takes water as he desires without a need for communication. The Demand, and the Arranged schedules, to be practical, need to have a restricted upper flow rate limit. This limit is usually physically imposed by system capacity, but it should not be appreciably restrictive of the farm manager's optimum operation or the value of flexibility is reduced.

The desirable and practical schedule has an arranged frequency, limited but large rate, and unrestricted duration within daily units. It is practical and essentially non-restraining on the farmer to have his anticipated rate and variations and the duration noted at the time of arranging. It may be that he might plan a moderate stream only during the morning so another user could be accommodated in the afternoon, or be allocated a moderate stream at the same time. The arranging

procedure enhances system usage. Reserve capacity for large variable streams should be designed into the system so that the farmer is guided but not precisely restrained at the anticipated arranged limit so that his management is not impaired.

FLEXIBLE SYSTEMS

Upgraded schedules invariably permit reducing the water and labor needed and, because of the better on-farm management made possible, can enhance crop production. These benefits at the farm level can justify more capital investment to upgrade the project capabilities--"the farm and the project are one financial unit." A representative increase in project efficiency is from 55% to 70%. Often the change is much greater. This implies that the average flow rate can be reduced where flexible schedules are introduced. However, it must not be used to imply that the peak rates may also be reduced. It is the variable and increased peak rates and the modified duration's that are the heart of flexible scheduling.

With the introduction of management input into scheduling, one of the first items it is desired to change is the elimination of night time operation. This is largely due to labor being inconvenient and increasingly difficult to obtain and the reduced capability to efficiently handle the water and observe crop conditions. The elimination of night irrigation essentially requires the doubling of the flow rate. Also to obtain reserve time to facilitate modifying frequency means that flow capacity in the lower part of a system should have nearly four times the steady flow rate of a rotation schedule. Further consideration indicates that the stream should be large enough to keep the irrigator economically busy and be able to make irrigation sets that essentially cover a whole field at a time. These are considerations the engineer must have in order to plan a project while "thinking like an educated farmer" to economically provide what is needed to not have irrigation restraints impede effective farm management. It must be realized that "it is not just the volume of water to be delivered, but the way it is delivered to make it effectively useful" that is important.

The system to accomplish this must have a source such as a reservoir to permit variable withdrawals. It may be the year to year supply reservoir. However, for operation flexibility it should be located reasonably near the final point of delivery so there is negligible lag when needed. This condition usually requires additional local storage facilities. It may be in-canal storage. It may come from an improved

on a distributory or even on a farm, or in other ways. The larger such storage is and closer to the delivery points, the more simply and uniformly the supply system can be operated and hence be smaller.

For illustration, a reregulating overnight (12 hr.) storage reservoir for a 1000 ac (400 ha) service area to satisfy .42 ipd ET at 70% efficiency which requires .60 ipd (15mm/day) would need to store

$$\frac{12 \text{ hrs.} \times .60 \text{ ipd}}{24 \text{ hrs.} \times 12"} \times 1000 \text{ ac} = 25 \text{ ac. ft. (3 ha m)}$$

For ease in operation it should store more, say 50 ac. ft (6 ha m) to permit a nearly steady inflow and have adequate reserve. If it were located near the center of the service area and had steady inflow which could be utilized in the upper half during the daytime it would need only about half the storage capacity.

5.0 ac. x 5' deep in a 1000 ac service area.

Such a reservoir can be gravity or pump supplied or emptied. The reservoir and land might cost \$50,000 (\$50/ac) and have an annual cost of \$6.00/ac/yr (\$15/ha/yr.). It could permit a very flexible schedule but a very steady flow in the main canal. Such systems are essentially ones in which the operational spillage from the upper area is reregulated for the next days use downstream. They provide a very simple technique for automation.

Increasing pipe system capacity and automating them for upgrading projects to flexible schedules, or in new designs, is economical in most cases when the on-farm benefits are considered as well as project benefits. For illustration: A sub area of 250 acres (100 ha) that could be operated (1) On a Rotation steady flow 24 hours/day schedule with one stream with 12 hour sets might require 8" (200 mm) diameter pipe. (2) It could be converted to operate daytime only using a 10" (250 mm) pipe in the upper half to use one and transmit one stream there and use the second stream in the lower half. This would require a 7% increase in cost. It would still have to be a rigid 12 hour schedule but no night time irrigation would be needed. (3) If capacity in the lower part were also doubled by using 10" (250 mm) the entire length and two streams were delivered at a farm turnout for 6 hours in the upper half and then for 6 hours in the lower half on a rigid schedule, the irrigation labor time would be cut in half for an increase of 14% in pipeline capital cost. (4) To provide a flexible two stream capacity system to up to two farmers simultaneously would utilize the system only half the daytime periods supplying appreciable reserve for

flexibility. It would use 10" (250 mm), 12" (300 mm), and 14" (350mm) pipe each for about one third of the length for a cost increase over 8" (200 mm) all the way of about 44%.

To illustrate relative cost. If the systems used 66'/ac of pipe (30 m/ha), and the 24 hour rotation using only 8" (200 mm) pipe cost about \$225/ac (\$560/ha), and a capital recovery factor of 12% is used, Table I provides a comparison of the costs of the pipe distribution for various schedules.

Table I. Relative Costs

Schedule	Percent	Capital Costs		Annual Costs	
		Per acre	Per hectare	Per acre	Per hectare
(1) 24 hour rotation	100	\$225	\$560	\$27	\$67
(2) 12 hour rotation	107	\$240	\$600	\$29	\$72
(3) 6 hour rotation	114	\$255	\$635	\$31	\$77
(4) 6 hour flexible	144	\$325	\$810	\$39	\$97

While Table I does not include all the costs for the various conditions, the distributory system pipe is the major variable as a dam and reservoir and main canal systems costs are quite similar for all alternates. These costs need to be considered from the view of a farmer who must ultimately pay them and who would think of them in terms of an annual increased water charge.

To compare (1) and (2) which only removes the night time use requirement, the annual charge to be added to the water charge for this is about \$2/ac/yr. (\$5./ha/yr) which any farmer would be willing to pay to avoid five to fifteen night time irrigations a year.

Comparing (1) to (3) which reduces the labor to half and also allows daytime only operation, the annual cost increase is \$4/ac/yr. (\$10/ha/yr). Such daytime operations would probably result in increased crop production but could not result in more efficient irrigation because no less water could be delivered with the rigid schedule.

Comparing (1) to (4) permitting flexible streams has consistently resulted in increased crop production, reduced water use, and reduced labor and made it more convenient. The annual cost for upgrading the pipe distribution portion of this project is about \$12/ac/yr (\$30/ha/yr).

CASE STUDIES OF FLEXIBLE SCHEDULE APPLICATION

These case studies from in the USA and developing countries illustrate application of various techniques to make possible the use of upgraded, more flexible irrigation delivery schedules with more control by the farmer as to frequency, rate, and duration. They report obtaining variable flow rates from different sources and by different techniques: direct from reservoirs; varying in-canal storage; on or beside the canal reservoirs; elevated terminal reservoirs; operational spillage in sloping canals reregulated or wasted; automated level top canals; elevated and depressed canals; supervisorial control of canal flow rates and storage; semi-closed and closed low pressure pipe lines; farmer controlled farm turnouts; flexible arranged schedules; low lift portable or fixed location pumps; high pressure automated pumps to elevated terminal reservoir.

Orange Cove Irrigation District, California, USA.

This 28,000 ac (11,000 ha) irrigation district (Chandler, et al 1990) (Merriam, et al 1990a) in the last few years has started a rehabilitation and upgrading program. The former 24 hr. limited rate arranged schedule operated by district personnel is upgraded to a limited rate arranged one with the available rate nearly doubled and the farm turnout gate being operated by the farmer during his arranged day or days. The former fixed rate is now variable. The water volume delivered is no longer a rate for 24 hour computation, but is measured by an in-line totalizing meter directly connected into the district main line and read once a month. The day and anticipated rates and duration are arranged a day ahead of use as was formerly done, but modifications are freely made by the farmer during the day.

For booster pumps on the farm it is now possible to take out water to exactly match needs at the desired pressure to operate the sprinklers at optimum conditions and for just the duration needed. It is now possible to have a runoff return flow cycling pump system return water directly into the farmer's closed low pressure field pipe line. The inflow to the pipeline from the district will automatically be reduced to maintain the set rate being applied on the field. Large initial and cut back flow rates can be set and the project delivery rate will continue to automatically match the rates applied to the field. All such variations in the lower service areas are automatically made back through the on-farm system through the meter and district's semi-closed float controlled pipeline (Merriam 1987a) system back to the Friant-Kern canal supply. Here the minor changes are absorbed by in-canal storage fluctuations.

The use of small in-canal fluctuations is made possible by the cooperation of the Friant Water User's Authority which took over canal operation a few years ago from the US Bureau of Reclamation. It is anticipated that similar upgrading programs will develop among the other district members of the Authority along the canal.

On the upper service areas above the canal, water is pumped to terminal reservoirs about 100' (30 m) above. Pumping can be concentrated during favorable power load conditions and as needed. The desired farm off takes are automatically supplied from the reservoir and pump.

The increased capacity and farmer controlled variable rates will reduce and make more convenient the on-farm labor needs and increase irrigation efficiency. In this water short project, this will provide the equivalent to 5% to 15% more water. A quotation from a letter from Engineer-manager James C. Chandler says, "I'm happy to report the unbelievable support I've received from the growers in the District." These are the people who are paying all the costs on the project and the farm.

Imperial Irrigation District, California, USA.

This District (as reported elsewhere in these Proceedings) has established a 17,000 ac (6,800 ha) pilot project. Here it will be possible for the irrigator to turn off the flow to the farm when he has applied enough water using a flexible duration rather than the previous 24 duration arranged schedule. Previously the irrigator was not confident of always being able to adequately complete an irrigation. This was because start up and shut off times often were an hour or so different than planned so the duration could vary appreciably from the planned 24 hours. Also the flow rate and the farmer's estimate of the needed water were not precise. To be sure of adequately completing the irrigation, as much as 10% excess water was arranged for.

With the introduction of a flexible duration arranged schedule, the irrigator is always sure of finishing the set so no excess flow is needed. This upgrading of the schedule was accomplished by having flow in the lateral excess to the arranged flows and collecting and reregulating the variable operational spillage in a reservoir for use later at a lower elevation. This is one of the simplest techniques for automating flow changes in sloping canals.

The objective of the variable duration schedule was to conserve water. It will be practical to extend the schedule to permit flow rate changes within limits as arranged. This will make it possible to match stream sizes to conform exactly with what is needed under varying conditions on the farm to improve irrigation efficiency by reducing runoff and deep percolation.

Later it will be possible to convert the farmers' distribution ditch to a level top downstream float controlled ditch or use a closed pipeline. With these techniques flow rate changes made in the field will automatically be matched by inflow changes at the lateral. Also cycling return flow systems can be pumped back to such a head ditch and the farm onflow rate will automatically be reduced by the same rate to provide a stable farm turn out flow rate. (This is the same capability for canal irrigation as described for the Orange Cove Irrigation District semi-closed pipe line system.)

Gadigaltar Tank Irrigation Pilot Project, Khargone, Madhya Pradesh, India (Merriam, 1990 b) (Merriam, 1991).

This project, construction of which has just been completed, supplies water to over 550 small farms on about 2,900 ac. (1150 ha) through 38 miles (64 km) of low pressure semi-closed (Harris float valve) concrete pipe system. It is an automated system permitting about forty to sixty farmers a day to operate their turnouts under a limited rate arranged schedule. Because of the project size and complexity, many techniques are used to simplify controls. The most involved aspect of the project is making the many contacts to arrange the numerous deliveries. This is done through a hierarchy of 76 contact men, each representing a group pipeline. They consolidate water orders into 10 locations which are then transmitted daily to a central office. In the system operation the only manual operation is to make a morning and evening setting of the storage reservoir outlet gate into the 3.0 mile long (5.2 km) sloping main canal to correspond to the water orders.

From this sloping canal, which always has water flowing through it with a planned operational spillage dropping into a reregulating secondary reservoir, supply pipelines take off to serve group areas of six to ten farms zero to three of which may take water at a time as arranged. Below the reregulating reservoir which has storage capacity for a day's flow to the area below it, a .6 mi (1.0 km) long level top canal maintained constantly full at a stable elevation at its upper end by an AVIO Neyrtec float controlled gate, supplies water to four large semi-closed main pipe lines feeding many supply pipelines serving the group areas.

The system has capacity to serve all the farm groups in five to seven ten hour days. The expected average irrigation frequency is about ten days to two weeks so there is appreciable reserve in unused days and extended evening hours to provide a flexible schedule.

The total cost of this 2900 acre project with its large 5600 ac. ft. (900 ha m) storage reservoir, 38 mile (64 km) pipeline system and appurtenance secondary reservoir, canals, etc. was close to \$3,000,000 (\$1,000/ac). Of this the distribution system cost was about \$1,000,000 and the pipe itself about \$350,000. A study to reduce the pipeline capacity to about one half which would lose the flexible schedule capability but not the daytime only ability showed the pipe cost would reduce to about \$250,000. This cost saving of \$100,000 represent about 3% of the project cost. At a 12% capital recovery factor, it corresponds to \$4/ac/yr. (\$10/ha/yr), out of an annual project cost of about \$120/ac/yr. (\$300/ha/yr), a negligible saving for the major benefits lost.

As the result of this pilot project, the Water Resources Department of Madhya Pradesh is recommending the use of pipelines as being more economical and desirable than small lined open channels formerly used for water distribution to farms.

Sri Lanka, Demand Irrigation Schedule Concrete Pipeline Pilot Project (Davids, et al 1990) (Merriam, 1987b, 1991).

This 375 ac. (150 ha) project using semi-closed low pressure concrete pipelines supplied by flexible sources had consistent paddy yield increases of 20% which was adequate to repay the cost of upgrading in two crop seasons.

Pakistan, Mardan Salinity Control and Redamation Project. (Merriam 1991).

This 40 ac (16 ha) first stage pilot project used 4,000 ft. (1200 m) low pressure concrete pipeline fed from a 500' (150 m) sloping lined canal converted to a level top by addition of a wedge on the top and maintained constantly full by a direct connection to a distributory canal. Yield increases were major being about 40% with up to 60% for the paddy where improved water management was very effective. As reported by the Supervising Engineer "The farmers have received it (the project) very well. The farmers of the adjoining area are visiting this office and requesting installation of the system in their fields."

REFERENCES

- American Society of Civil Engineers On-Farm Irrigation Committee, (1984). Recommended Irrigation Schedule Terminology. ASCE, I&DD Proceedings, July 1984. pp 219.
- American Society of Civil Engineers, (1987). Delivery System Scheduling, ASCE, I&DD Symposium Proceedings, July 1987. Planning, Operation Rehabilitation and Automation of Irrigation Water Delivery Systems, pp-18-80.
- Chandler, James C., Moss, Richard M., and Merriam, John L. (1990). Automated Low Pressure Pipe for Flexible Deliveries, Orange Cove Irrigation District, California. ICID 14th Congress, Trans. 1990. Vol. 1-D, Symposium, pp 51-58.
- Davids, Grant and Merriam, John L. (1990). Sri Lanka Social, Agricultural, and Economic Conditions Upgraded with a Demand Irrigation Schedule. ICID 14th Congress Trans., Vol 1A, Q42 pp 1-12.
- Merriam, John L. (1987). Design of Semi-Closed Pipeline System. ASCE I&DD Symposium Proceedings July 1987. Planning, Operation Rehabilitation and Automation of irrigation Water Delivery Systems. 1987. pp 224-236.
- Merriam, John L., de Silva, N.G.R., and Bandaragoda, D.J. (1987b). Six Seasons of Demand Schedule Irrigation for Improved Water Management in Sri Lanka. ICID 13th Congress Trans. Vol 1B. pp 1471-1501.
- Merriam, John L., Chandler, James C., and Moss, Richard M., (1990 a). Upgrading of the Orange Cove Irrigation District Water Distribution Systems. ASCE Proc. I&DD, July 1990, pp 70-76.
- Merriam, John L. (1990 b). Gadigaltar Tank Irrigation Pilot Project. A Farmer Managed Variable Delivery Systems. ISPAN 1611. N. Kent St., Rm 1001, Arlington, VA. 22209.
- Merriam, John L., (1991). Flexible Irrigation Supply Pilot Projects. Part I, Principles. Part II, Sri Lanka, Pakistan, India, Egypt. ASCE I&DD Proceedings, July 1991. pp88-101.

CANAL LININGS USED BY THE BUREAU OF RECLAMATION WITH EMPHASIS ON REHABILITATION

Thomas R. Haider¹

ABSTRACT

Designers, and others interested in water resource development, have strived to improve the cost effectiveness and technical properties of canal liners. Reclamation (the Bureau of Reclamation) has been involved in this endeavor for many years. Although the majority of Reclamation canals have been successfully lined with either concrete or compacted earth, a need was recognized for the development of alternative linings, along with the improvement of linings already in use. This paper will present a brief history of canal linings tested and used by Reclamation in the past and those currently under investigation, with an emphasis on linings which may be used for rehabilitations. The types of linings discussed include standard concrete, concrete placed underwater, shotcrete, compacted earth lining, compacted lime treated earth lining, soil-cement, buried geomembranes, exposed geomembranes, and geocomposites.

INTRODUCTION

It is the policy of Reclamation to line open channels when required to conserve water and secure other benefits. There are many factors that influence the type of lining chosen, and no single lining type can be recommended to satisfy all situations. Information on Reclamation lining criteria and practices appears in a variety of publications and papers, including the discontinued publication entitled "Linings for Irrigation Canals" [6]. While much of the information in this publication is still applicable, the publication was discontinued because there are areas where technological updates are required. A paper entitled "Interim Report On Canal Linings Used By The Bureau Of Reclamation" [4] will replace the above publication until it is updated. In addition to the above publication, information related to canal linings may be found in "Design

¹Principal Designer, Water Conveyance Branch, Civil Engineering Division, Denver Office, Bureau of Reclamation

Standards No. 3" [1], "Performance of Plastic Canal Linings" [7], and "Performance of Granular Soil Covers on Canals" [5].

HISTORY

From 1946 to 1962, Reclamation was involved in a lower cost canal lining study program, which culminated in the aforementioned publication, "Linings for Irrigation Canals". During the 16 years of study, 2,570 miles of lower cost linings and 420 miles of reinforced concrete linings were installed on Reclamation canals. The lower cost linings included unreinforced concrete, shotcrete, soil cement, asphaltic concrete, exposed asphaltic membranes, exposed plastic and synthetic rubber films, prefabricated concrete blocks, prefabricated buried asphaltic membranes, buried plastic and synthetic rubber films, bentonite membranes, thick compacted earth lining, thin compacted earth lining, and loosely placed (uncompacted) earth blankets.

Approximately 6,600 miles of canals have been constructed by Reclamation since the early 1900's. The "Linings for Irrigation Canals" document compared lining types for 2,993.8 miles of canals built between 1946 and 1962. It is estimated that approximately 1,400 miles of canals were constructed between 1962 and 1986. Table 2 shows, by percentage, an estimate

Table 1 - Percentages of types of linings on Reclamation-constructed canals

TYPE OF LINING	FROM 1963 PUBLICATION (3,000 MILES)	1963 TO 1992 (1,470 MILES)	TOTAL USBR CANALS (6,770 MILES)
Concrete	56%	55%	57%
Buried membrane			
Hot asphalt	11%	---	5%
Plastic	0.00004%	8 %	2%
Other	0.007%	---	---
Compacted earth	19%	37%	28%
Other	14%	---	8%

of the types of linings used on canals constructed during these two periods and also for all Bureau of Reclamation canals constructed since its inception in the early 1900's.

Table 1 clearly shows that unreinforced concrete lining has been the dominate lining used by Reclamation, for the construction of new canals, followed by compacted earth lining. Although geomembranes do not make up a large percentage of lining used by Reclamation, their use has increased dramatically in recent years.

BASIC LINING TYPES

Compacted Earth Lining

The lining of choice is a compacted earth of gravel and sand with clay binders or poorly graded gravel-sand-clay mixtures with a minimum thickness of 2 feet normal to the finished canal prism, if available within an economical haul distance. If properly maintained, this lining provides excellent seepage control (approximately $0.07 \text{ ft}^3/\text{ft}^2$ of prism/day) and excellent erosion protection. Table 2 shows the ranking of various earth materials (1 being best) with respect to use as compacted earth linings.

On the positive side, compacted earth linings can withstand colder temperatures with less damage than concrete lining; have a greater ability to tolerate frost heave, although a reduction in unit weight will usually occur due to frost action; can tolerate greater water surface fluctuations with less damage than can concrete or buried geomembrane lining; generally do not require as much foundation preparation as concrete or buried geomembrane linings; can tolerate certain expansive materials near the prism; and require no special equipment or technology for construction, which usually results in competitive pricing.

Negative attributes of compacted earth lining are the larger prism size and lower velocity required; potential erosion problems with borderline lining materials; and the care required to protect the integrity of the lining when cleaning the canal.

The following criteria are minimal guidelines for the layout and design of compacted earth linings and should be tempered with engineering judgment.

Table 2 - Suitability of different soils for compacted earth lining

TYPICAL NAMES OF SOIL GROUPS	GROUP SYMBOLS	RANKING FOR EROSION	RANKING FOR LINING
Well-graded gravels, gravel-sand mixtures, little or no fines	GW	2	-
Poorly graded gravels, gravel-sand mixtures, little or no fines	GP	3	-
Silty gravels, poorly graded graded gravel-sand-silt mixtures	GM	5	6
Clayey gravels, poorly graded gravel-sand-clay mixtures	GC	4	2
Gravel with sand-clay binder	GW-GC	1	1
Well graded sands, gravelly sands, little or no fines	SW	8	-
Poorly graded sands gravelly sands, little or no fines	SP	9 ¹	-
Silty sands, poorly graded sand-clay mixture	SC	10 ¹	7 ²
Sand with clay binder	SW-SC	6	3
Inorganic silts and very fine sands, rock flour, silty or clayey fine sands with slight plasticity	ML	-	8 ²
Inorganic clays of low to medium plasticity, gravelly clays, sandy clays, silty clays, lean clays	CL	11	5
Organic silts and organic silt-clays of low plasticity	OL	-	9 ²
Inorganic silt, micaceous or diatomaceous fine sandy or silty soils, elastic silts	MH	-	-
Inorganic claus of high plasticity, fat clay	CH	12	10 ³
Organic clays of medium to high plasticity	OH	-	-

¹If on the coarse end of gradation.

²Erosion critical.

³Volume change critical.

Table 3 gives the compacted earth lining thicknesses, in feet, for various ranges of water depths. Table 4 gives the the freeboard above the normal water surface for the top of the lining and top of the

bank. Table 5 gives the minimum b (bottom width) to d (water depth) ratios for various capacity ranges.

Table 3 - Thickness of compacted earth lining

WATER DEPTH (feet)	BOTTOM (Vertical) (feet)	SIDE (Horizontal) (feet)
2.0 or less	1.0	3.0
2.0 to 4.0	1.5	4.0
4.0 to 6.0	2.0	6.0
6.0 to 20.0	2.0	8.0
20.0 or more	3.0	8.0

Table 4 - Freeboard above normal water surface

CAPACITY RANGE ft ³ /s	EARTH LINING (feet)	CONCRETE LINING (feet)	BANK HEIGHT (feet)
0 to 40	0.5	0.5	1.1 - 1.25
40 to 200	0.5	0.5 - 0.86	1.25 - 2.4
200 to 500	0.5 - 0.75	0.86 - 1.25	2.4 - 3.0
500 to 1,500	0.75 - 1.15	1.25 - 1.8	3.0 - 3.9
1,500 to 3,500	1.15 - 1.45	1.8 - 2.2	3.9 - 4.6
3,500 to 7,500	1.45 - 1.75	2.2 - 2.6	4.6 - 5.2
7,500 to 10,000	1.75 - 2.1	2.6 - 3.1	5.2 - 6.2

Table 5 - Minimum bottom width, b, to water depth, d, ratios

CAPACITY RANGE ft ³ /s	EARTH	CONCRETE
0.25 - 25	2.0	1.0
25 - 100	2.0	1.2
100 - 500	2.5	1.2
500 - 1,000	3.0	1.3
1,000 - 2,500	3.5	1.3
2,500 - 5,000	4.0	1.5
5,000 - 7,500	5.0	1.8
7,500 - 10,000	6.0	2.0
10,000 - 15,000	7.0	2.5
15,000 - 20,000	8.0	3.0

The plasticity index, PI, should be greater than 12, the liquid limit, LL, should be less than 45, and

the tractive force, TF, should be less than 0.65. The Mannings "n" is 0.025 for capacities less than 100 ft³/s and 0.0225 for capacities greater than 100 ft³/s.

Concrete Lining

The greatest percentage of Reclamation lined canals have concrete lining. Economics was usually the determining factor, but concrete linings were also used for mandated situations and technical reasons.

On the positive side, concrete linings have better hydraulic characteristics, including steeper side slopes (usually 1-1/2:1), resulting in a smaller canal prism; provide a seepage rate comparable to compacted earth lining (approximately 0.07 ft³/ft² of prism/day), if properly designed, constructed, and maintained); present a hard, impenetrable barrier against burrowing animals; and significantly reduce weed growth in the canal prism. Finally, from a safety standpoint, reinforced concrete panels with water stop joints may provide the required structural capability and seepage control in critical areas where a canal bank failure could result in loss of life and/or damage to improvements, such as farm and residential structures, railroads, highways, etc..

Negative attributes are the extensive foundation treatment required for low density or highly expansive material; extensive and expensive underdrainage system required, when high groundwater is present; potential damage if the foundation is a frost susceptible soil; and the greater hazard potential to humans and animals because of higher velocities and steeper hard surfaced side slopes.

The following criteria are minimal guidelines for the layout and design of unreinforced concrete lining and should be tempered with engineering judgement. Table 4 gives the freeboard above the normal water surface for the top of the lining and top of the bank. Table 5 gives the minimum b (bottom width) to d (water depth) ratios for various capacity ranges. Table 6 gives the concrete lining thicknesses and contraction joint spacing for various capacity ranges. The canal bottom grade, s, must be less than 0.3 times the critical energy slope, s_c. Mannings "n" is 0.014 for a hydraulic radius, r, of 4 or less, and may be determined by:

$$n = 0.0463r^{1/6} / \log[14.8(r/0.005)]$$

when r is greater than 4.

Table 6 - Guidelines for the design of unreinforced concrete lining

CAPACITY RANGE (ft ³ /s)	LINING THICKNESS (inches)	CONTRACTION JOINT SPACING (feet)
0 - 500	2-1/2	10
500 - 1,500	3	12
1,500 - 3,500	3-1/2	14
3,500 - 7,500	4	15
7,500 - 20,000	4-1/2	15

Membrane Lining

Tests on various membranes date back to the 1950's. Most of the test membranes in this era were asphalt based. Although test results on these membranes were encouraging technically, some membranes were labor intensive to install. Increased prices related to oil shortages in the 1970's made asphalt membranes uneconomical, and investigations were suspended. However, the use of buried PVC lining gained in popularity a few years later when better quality control and manufacturing techniques provided for higher quality and heavier plastic sheets at a competitive price. The majority of buried geomembrane used by Reclamation to date is 10 and 20 mil PVC.

Positive attributes are that a buried geomembrane may be placed during colder periods of weather; is especially adaptable for rehabilitating existing earth canals; is the type of lining least affected by frost heave or expansive material in the proximity of the canal prism; can tolerate greater water depth fluctuations than any other types of lining, if the cover material over the plastic is specifically designed to accommodate this condition; and provides a seepage rate equal to or less than that for concrete or compacted earth.

Negative attributes of a buried geomembrane are that the subgrade must be relatively smooth and free of sharp rocks, roots or other objects which may puncture the membrane; a side slope of 2-1/2:1 is usually required for stability of the cover material; the cover material, which requires a specific gradation, must be available from a local source to be economically feasible; an approved soil stabilant

is required on the subgrade prior to placing PVC if weed growth is anticipated; and it is difficult to determine the location of damage once the cover material has been placed.

The following criteria are minimal guidelines for the layout and design of buried geomembrane linings and should be tempered with engineering judgement. The velocity range is from 1 to 3 ft/s, depending on the quality of cover material. Mannings "n" for earth canals is usually 0.025 for capacities less than 100 ft³/s and 0.0225 for greater capacities. If the cover material is coarse, then Mannings "n" should be checked by the Strickler equation to determine if it should be increased. The Strickler equation is:

$$n = 0.0342 d_{50}^{1/6}$$

where d_{50} is the diameter of the particle, in feet, for which 50 percent of the material, by weight, is smaller. The thickness of the cover material is calculated by:

$$c = 10 + d/12$$

where c is the cover material thickness, in inches (12-inch minimum), and d is the water depth in inches. Additional criteria are discussed under "Buried Geomembrane Rehabilitation" later in this paper.

REHABILITATION SITUATIONS

The most common reasons for rehabilitation are general deterioration of the lining or the addition of lining in canals that were initially constructed without lining. Other reasons for rehabilitation include problems with highly expansive foundation material, low density foundation material, soils susceptible to frost heave, and hydrostatic back pressure.

General Deterioration and Lining of Unlined Canals

Hundreds of miles of canals built in the early 1900's have experienced excessive deterioration, and canals that were initially constructed without any lining now require lining. Recent rehabilitations have favored geomembranes, but compacted earth and concrete have been used in specific cases.

Compacted Earth Lining Rehabilitation: If acceptable earth lining material is available near an existing canal requiring a new lining, a compacted earth will probably be the most economical lining. This was the option chosen to line portions of the Montezuma Valley Irrigation Company Lone Pine and Upper Hermana Laterals, located in southwestern Colorado, as part of the Colorado River Salinity Control Program.

Concrete Lining Rehabilitation: Concrete lining is usually used to rehabilitate old concrete-lined canals, especially if the major in-line structures are still in good condition, because of right-of-way, structural, and hydraulic gradient restrictions. Concrete lining may also be used to rehabilitate old earth canals, especially in an urban setting where right-of-way is restricted. This was true for a portion of the Government Highline Canal that passed through Grand Junction, Colorado.

Buried Geomembrane Rehabilitation: Buried PVC was installed in test sections on the Tucumcari Project in New Mexico and the Kennewick Irrigation district in Washington, and was used to rehabilitate portions of canals on the Helena Valley Unit in Montana, the East Bench Unit in Montana, the Riverton Unit in Wyoming, and the Government Highline Canal near Grand Junction, Colorado. Installations included both 10 and 20-mil sheets. Evaluations of buried membrane linings resulted in the following conclusions:

a. The thickness of the PVC should be a minimum of 20-mils (30 mils if heat seams are required). The 20 mil thickness provides more toughness and laboratory tests show that there is less aging (loss of plasticizers) with the thicker sheets. Aging increases tensile strength, decreases elongation properties, and decreases impact resistance. Test results also indicate that there is less aging with smooth subgrades.

b. The optimum side slope is 2-1/2:1 for stability of the cover material, unless the highest grade cover material is available. Cover material should fall between the gradation limits shown in Table 7, with the coarser limits more desirable.

c. The PVC should be covered immediately after installation with the surface temperature of the sheet between 35 and 90 degrees F, unless tests show there is no damage outside these temperatures.

d. If there were extensive vegetation in an existing canal that is to be rehabilitated with PVC, the foundation should be treated with an approved soil sterilant. Woody growth should not be allowed to take hold in the rehabilitated prism or on the bank near the top of the plastic sheet.

Table 7. Gradation for PVC lining cover material

Seive Size	Percent Retained	
	Upper Limit	Lower Limit
5 inch	0	-
3 inch	20	0
1-1/2 inch	-	10
3/4 inch	80	-
3/8 inch	90	-
#4	-	50
#8	100	60
#30		77
#200		90

Other buried geomembranes tested include very low density polyethylene (VLDPE) and a polyolefin composite lining, both placed in the Belle Fourche Unit in South Dakota. The VLDPE sheet was 30 mils, and tests after 2 years showed no deterioration, but tests just recently taken indicate possible problems, and it is recommended that this material be used with caution until further studies can be completed.

The polyolefin composite consists of 3.5-oz/yd² needle-punched nonwoven polypropylene geotextile laminated to both sides of a 2- to 3-mil thick low density polyethylene (LDPE) sheet. The geotextile gives the composite strength and a texture to eliminate the sloughing of the cover material. The side slopes in the test section are 1-1/2:1, and the cover material has remained stable. This test is only 3 years old, and since preliminary tests on this and other "geocomposites" indicates that the geotextile and geomembrane may delaminate with freeze-thaw and/or wet-dry cycles, additional evaluations should be conducted before these materials are used extensively. Other "texturized" geomembranes should be considered in future evaluations.

A special case of buried geomembrane is bottom lining only in loessial soils. Because the permeability of loess is basically vertical, the seepage can be

reduced from 50 to 60 percent by bottom lining only. This system has been successfully used on canals in Nebraska.

Exposed Geomembrane Rehabilitation: A variety of geomembranes have been considered for use as exposed liners for canals, some of which have been used as pond liners. Exposed geomembranes require gravel cover in the invert to help anchor the lining when the canal is empty. Potential advantages of exposed geomembrane linings are 1-1/2:1 side slopes, elimination of cover material on side slopes, easily identifiable damage, and more easily replaced damaged lining. Potential disadvantages are cost of the geomembrane, adverse wind and water forces, possibility of vandalism and animal damage, minor ultraviolet degradation, and abrasion.

A test section of 30-mil HDPE was installed on the Bostwick Division in Kansas. The material is in good condition except for a few small holes believed to be caused by deer. In addition, an exposed lining of VLDPE has been installed on the same canal, but future use of this material should be minimized until further evaluation is accomplished as previously stated.

Approximately 3 miles of a reinforced rubberized bituminous geomembrane was installed by the Kennewick Irrigation District in Washington in 1987 and tests in 1992 indicate that the material has experienced some delamination. Further studies are under way to determine if this is typical of this material or if a change in the formulation of this material will make it an acceptable alternative.

Underwater Lining of Existing Canals: There are many canals that require new lining for seepage control but cannot be taken out of service because they require year round operation. To solve this problem, Reclamation developed a system for underwater placement of a geomembrane lining with a protective concrete cover. A demonstration section of this lining system was placed on the Coachella Canal near Niland, California. A trimming machine was developed to shape the prism underwater. A special lining machine followed which placed the geomembrane (30-mil PVC on the invert and 3.4-oz/yd² nonwoven geotextile bonded to 20-mil PVC on the 2-1/2:1 side slopes) followed by the concrete protective cover. More detailed information can be found in "In-service Lining of Existing Canals" [3].

Concrete/shotcrete on Geocomposites: In addition to the underwater lining, studies have been made on the placement of concrete or shotcrete on geocomposites. Reclamation performed laboratory tests on placement of shotcrete on a geocomposite, although no field applications have been made to date. A short reach (1-1/2 mile±) of the Coachella Canal, in California, was constructed of hand placed concrete lining on a geocomposite of nonwoven geotextile glued to a PVC geomembrane.

Highly Expansive Foundation Material

If highly expansive material is used as a canal foundation or as compacted earth lining there is a very good chance that rehabilitation will be required. If acceptable material is available, the expansive material should be removed and replaced. If acceptable material is not available, lime treatment may be an acceptable alternative.

Reclamation's Friant-Kern Canal, located near Fresno, California, has extensive reaches of earth and concrete-lined sections situated in extremely fat clay. The side slopes of the earth and concrete-lined sections, and even 3:1 test sections, slumped into the canal when the soil became saturated. The canal lining was rehabilitated with lime treatment because there was no other acceptable material available. Hydrated lime or granular quicklime was added at the rate of 4 percent by the dry weight of the soil and thoroughly mixed until 100 percent would pass the 1-3/4-inch screen and 60 percent would pass the #4 screen. The mixing was required to be completed within 6 hours. Water was added until optimum moisture, or just above, was achieved. The exposed treated soil was sealed by a rubber tired roller, and the soil cured for a minimum of 2 days to a maximum of 7 days, then was placed and compacted to a 2-foot depth in the invert and on the O&M roads, and for an 8-foot horizontal distance on the canal prism side slopes. The material was pulled into the canal invert, where the lime was added and mixed in. The lime-treated material was then compacted back into place. The first rehabilitation, both 2:1 earth and 1-1/2:1 concrete-lined sections, was completed in 1974 and remains in excellent condition. Safety ladders were eventually installed on the earth side slopes because the lime-treated soil remained too firm to make escape possible.

Low Density Foundation Material

Reclamation's Earth Manual [2] states that low density material that has historically never been wet usually has the potential for collapse. These areas should be treated by removal and recompaction or by prewetting. Since both of these solutions are very expensive, a minimal amount of treatment is usually expended, based on the findings of preconstruction geologic exploration and tests performed during construction. For this reason, pockets of low density material may be missed. The problems are usually more pronounced on concrete-lined canals than on earth-lined canals. The problem of collapse becomes apparent in earth canals as soon as the soil collapse begins; therefore, the diagnosis and treatment is easier.

Experiences on Reclamation's concrete-lined Mirdan Canal in Nebraska, constructed in a low density loess, indicate that the most serious problem is likely to occur when the canal prism is constructed in cut on the uphill side of the canal and on fill on the downhill side of the canal. This situation leaves low density material adjacent to the canal lining on the uphill side. If this material becomes saturated, because of cracks in the concrete lining, it collapses, resulting in larger cracks in the lining. A shear plane also forms in the soil during collapse, allowing a path for water to move farther into the low density material. The collapse sequences continue, forming a pattern of cracks and shear planes that look like closed contours, when viewed in plan. As long as the shear planes close on themselves, the water will be contained, but once a shear plane intersects the downhill slope of the canal embankment, water and silt particles can daylight, resulting in a failure and washout of the canal. This scenario occurred on the Mirdan Canal, resulting in a canal washout.

The same series of events started at another location. The canal was temporarily shut down, all cracks and discontinuities in the lining were worked over to eliminate sharp edges, a temporary sheet of PVC was placed over the lining and anchored to the lining at the upstream and downstream ends, and strings of sandbags were placed at intervals along the side slopes to hold the plastic down. This allowed canal operations to continue until the end of the irrigation season.

The following method was used to rehabilitate the Mirdan Canal at both locations. All concrete lining was removed in the damaged area plus some distance upstream and downstream. All suspected low density material was removed and recompacted in place. A 40-mil sheet of HDPE (high density polyethylene), with heat sealed joints, was placed across the entire canal prism, and then Fabric form was placed on the side slopes. When the Fabric form was pumped full of concrete mortar, it matched the original concrete lining. This method was used to provide a watertight lining in case there was still some low density material still present.

After these two areas were repaired, other suspected areas were treated by injecting a silt slurry to consolidate the low density material. Stabilization of low density loess by silt injection, discussed in "The Stabilization of Soil by the Silt Injection Method For Preventing Settlement of Hydraulic Structures and Leakage from Canals" [9], may be used after construction as problems develop in areas that were not identified prior to or during construction.

Silt Foundation Material in Locations with Freeze Potential

Special care should be taken when a canal is constructed on a silt material since an ice crystal formation adequate to damage thin unreinforced concrete lining may develop, even with no free water surface present. A moisture content in silt of 2 percent greater than optimum can lead to damage of unreinforced concrete lining from frost action. If concrete lining is used on frost susceptible silts, all fill material should be placed on the low side of optimum. During construction, the prism should be graded such that storm water will run off and there will be negligible ponding of water. Cracks that do form in the lining should be sealed as soon as possible.

Hydrostatic Backpressure

Hydrostatic pressure in the soil behind any canal lining can be troublesome in many situations. Following are selected situations and solutions:

High Groundwater: If high groundwater is in or develops in the area of the canal, the canal cannot be drained below the groundwater level without damage to the canal. One solution is to keep water in the

canal year-round. If this is not practical, the best solution is to design a new cross section that is wide and shallow, so the canal invert can be raised above the groundwater. If the original canal is concrete lined, the rehabilitation could be buried geomembrane with a sand and gravel cover. The normal depth of this type section is usually less than that for a concrete-lined section, and some minor movement can be tolerated with a buried geomembrane.

Perched Groundwater: Sometimes the canal will act as a dam and will intercept perched groundwater. If damage to the concrete lining is apparent but the damage does not require removal and replacement, then a drainage system can be installed under the O&M road to intercept this groundwater. The drainage can be daylighted into natural drainages that have culverts under the canal. If the lay of the land is such that natural drainages are great distances apart, then the drainage can be taken to pump sumps controlled by floats.

If the damage to the lining is extensive, then an underdrainage system can be placed under the new lining, with the hydrostatic pressure being relieved by flap-valve weeps. These weeps are designed to allow water flow only in one direction. This type drainage system is further discussed in the "Interim Report on Canal Linings Used by the Bureau of Reclamation" [4].

REFERENCES

1. "Canals and Related Structures, Design Standards No. 3". 1967. Bureau of Reclamation.
2. Earth Manual, Second Edition. 1974. Bureau of Reclamation. 800p.
3. Edwards, D.K., W.L. Long. "In-Service Lining of Existing Canals". 1990. Water and Wastewater 90 Conference, Barcelona, Spain.
4. Haider, T.R., T.G. Mitchell. "Interim Report on Canal Linings Used by the Bureau of Reclamation". 1988. Bureau of Reclamation. 31p.
5. Jones, C.W. "Performance of Granular Soils Covers on Canals". 1981. Bureau of Reclamation Reprt No. REC. ERC-81-7. 62p.

6. "Linings for Irrigation Canals". 1963. Bureau of Reclamation. 145 p. (Discontinued)
7. "Morrison, W.R., J.G. Starbuck. 1984. "Performance of Plastic Canal Linings". Bureau of Reclamation Report REC-ERC-84-1. 114p.
8. "Morrison, W.R. "Use of Geomembranes in Bureau of Reclamation Canals" (To be published in late 1992, early 1993). Bureau of Reclamation.
9. Johnson, G.E. "The Stabilization of Soil by the Silt Injection Method for Preventing Settlement of Hydraulic Structures". ASCE Paper, date unknown.

**THE CALIFORNIA FARM WATER COALITION:
TELLING THIRSTY CALIFORNIANS WHY AGRICULTURE
NEEDS WATER**

Stephen K. Hall¹

Shelley Vuicich²

ABSTRACT

The allocation of water for agricultural use in the western United States is currently being called into question. This scrutiny is most keen in California, a state with more than nine million acres of irrigated farmland. Rapidly growing urban demands and calls for environmental restoration are placing increasing pressure on existing water supplies, while the development of new supplies is both expensive and politically unpalatable.

This convergence of new demands and stagnation in the development of new supplies is fueling an all out assault on farmers' water rights. For the first time in this century, farmers across the West are facing the question of whether their legal water rights are the secure property rights they once were considered to be.

The California Farm Water Coalition was formed in 1989 to give agriculture a voice in the highly charged debate on water allocation now underway in California. Farmers and agricultural water district officials believe that agriculture's single largest enemy is public apathy and ignorance over the industry's use of water and the benefits that water use creates. The Farm Water Coalition strives to educate the public and policy makers about agricultural water use. The Coalition's mission is based on the belief that informed policy makers will make good decisions.

THE COALITION'S ROLE

For the past six years, an ongoing drought, coupled with burgeoning population growth, has stretched California's water supplies to the limit. Consequently, a great deal of attention has been focused on the state's water allocation and distribution policies. As headline after headline proclaimed that agriculture receives 80 percent of the developed water

¹Executive Director, California Farm Water Coalition, Fresno, California

²Special Projects Officer, California Farm Water Coalition, Fresno, California

supply, while contributing only three percent of the state's economy, farmers found themselves to be the target for proponents of water reallocation. These proponents argue that if agriculture did without 10 percent of its water supply, all of the state's water needs could be met.

As cries of "reallocation," "water transfers," and "water marketing" emerged, farm water managers throughout the state recognized that the industry had to go on the offensive. Something had to be done to counteract the misinformation about farm water use in order to preserve agriculture's water supply.

As a result of a series of meetings among agricultural water managers and industry representatives, the California Farm Water Coalition, a non-profit organization, was incorporated in July, 1989. The Coalition is governed by a Board of Directors selected from among prominent agricultural leaders concerned about water policy. The Board meets monthly and provides guidance for the Coalition's staff and consultants.

The Coalition receives its funding from voluntary sources. Local water districts throughout California contribute on a voluntary basis to the Coalition with annual dues of \$0.10 per irrigable acre. Additional funding is received from agribusinesses and allied industries, as well as individual donations.

For three years, the California Farm Water Coalition has taken its education message to three specific publics: the media, elected representatives and policy makers, and the business community. These audiences are key in terms of the water policy debate and the Coalition focuses on these groups with information that is accurate, timely and relevant to the issues at hand.

PROGRAM AND EVALUATION

Because of limited time and resources, the Coalition assessed early-on the areas in which it could be most effective. Through this evaluation process the Coalition concluded that its efforts should focus on three distinct publics: the media, elected representatives and policy makers, and the business community. These three publics are critical in terms of providing input into the water policy debate in California.

The Media

The California media have given water issues, ranging from agricultural drainage to salmon spawning habitat, considerable coverage. Water issues are covered by a cadre of beat reporters who cover the issue on a full-time basis. Additionally, most of the major urban dailies have editorial writers who specialize on the subject.

As the primary disseminator of information to the public, the media was identified by the Farm Water Coalition as a critical audience to receive agriculturally oriented information. Articles and editorials appear daily in California and national publications, many of which contain misinformation about agriculture's water use. The Coalition counters on a daily basis any erroneous and misleading statements. Through direct contacts with reporters, letters to the editor, and the submission of opinion-editorial pieces, the Coalition has been able to build a good working relationship with the media. Through these relationships, the Coalition attempts to create awareness and trust. Reporters and editors call the Farm Water Coalition on a regular basis, and recognize that the organization is able to speak on behalf of agriculture with respect to water issues.

The Coalition regularly provides agricultural spokespersons for both print and electronic media. Last year, the Coalition was selected to represent the agricultural perspective on a "Good Morning America" segment on the California water crisis. Also, the Coalition has been invited to provide guest editorials in leading newspapers throughout the state.

The Coalition now is recognized as a leading resource for reporters on water issues. Its goal is to provide facts and figures to all requests for information. The Coalition also has developed position papers supporting the development of California's groundwater banks, off-stream storage reservoirs and Delta transfer facilities as a means of better water management for the state.

Elected Representatives and Policy Makers

The Coalition subscribes to the theory that people will make rational decisions if they have adequate information regarding all of the facts. Consequently, elected representatives and policy makers are a targeted audience for the Coalition's efforts.

The Coalition uses a two-pronged approach in working with elected representatives and policy makers. It believes that personal contacts with decision-makers, as well as public addresses to key audiences is important in delivering its message to this defined audience.

The Coalition, at its monthly board meetings, invites members of the state legislature to discuss water issues as they relate to state policy issues. Additionally, the Coalition staff will conduct one-on-one meetings with elected representatives and their staffs as water issues emerge, and to educate them on the agricultural perspective. As a result of these efforts, the Coalition is called upon to deliver testimony to the state legislature on a variety of water issues. And because it speaks for agriculture generally, it has been called upon to prepare briefing papers for candidates at all levels of government, including the upcoming Presidential election.

In reaching policy makers and members of state agencies that impact water policy in this state, the Coalition uses its strategy of personal contact. It

also seeks opportunities to present its message in the public forum when key audiences are present. In 1991 alone, the Coalition delivered more than 56 speeches on topics ranging from agricultural water conservation to water marketing. Demand for Coalitions spokespersons is high and come from all over California, as well as other states.

The Coalition also reaches out to elected representatives and policy makers by sponsoring opportunities for discussion and consensus building. The Coalition has taken a lead role in developing solutions to the water problems California faces. Three-Way Meetings among agriculture, urban and environmental representatives have been sponsored by the Coalition to define potential solutions. The result of these discussions has been an increased trust of agriculture and the acknowledgement of the complex nature of the problem. These discussions are being followed closely and supported by Governor Pete Wilson's office and members of his staff.

The Business Community

Agriculture has long enjoyed a good relationship with members of the business community; they are natural allies. Because agriculture and the business community share many of the same ideas and goals, business was identified as a principal public. Consequently, the Coalition has focused a portion of its educational efforts at this public.

The Coalition looks well beyond agribusiness and allied industries when addressing the business community, although its efforts started there. The Coalition dedicated a portion of its time to bring allied industries and business together with farmers to strengthen the voice for agricultural water. Farmers represent only three percent of California's population. By joining forces with all segments of the agriculture industry, its messages will be better heard.

The Coalition has responded to requests from the business community for information about agricultural water use. Increasingly, California businesses have become active in the water policy issues of the state. Therefore, it is mandatory that the Coalition provide updated information to these business leaders so that they, too, can make informed decisions.

The Coalition has addressed members of the business community in open forums. Also, the Coalition has written opinion pieces and placed advertorials in publications that are read by business leaders. Members of the business community also receive "Farm Water Facts," a bi-monthly newsletter published by the Coalition. This newsletter also is distributed to the media, elected representatives and policy makers, and members of the environmental community.

This is a time when farm unity is crucial, and the Coalition has formed an agricultural caucus, bringing together the combined interests of the entire industry to develop unified policies on such issues as water transfers and

agricultural conservation. These policies have been effective in galvanizing farm support behind a common position, and then communicating that position to their primary audiences.

The Coalition's educational efforts are conducted statewide, with no particular allegiance or alliance to one area of the state or one commodity. The Coalition represents farmers and water districts which rely on surface water, from local water projects, as well as those who buy water from the federal Central Valley Project and the State Water Project, and those who supplement their supplies with groundwater.

CONCLUSION

Since its inception, the California Farm Water Coalition has kept its basic mission: public education about agricultural water use. Through its programs, the Coalition has experienced numerous opportunities to educate key publics about the agriculture industry, its use of water, and how its water use benefits all of California.

By gaining a reputation as a credible representative of the agriculture industry, it has been invited to participate in discussions, round tables and seminars that deal with shaping water policy in California. As a result, agriculture has secured another seat at the table when policy is being discussed and has ensured that agriculture's opinion will be solicited when decisions are being made.

The Coalition is dedicated to continuing its efforts to ensure that reasonable water policies are developed for California, policies that are balanced and do not cause undue hardship on one segment of the water using population. California agriculture is an integral and essential part of the state's economy and it is crucial to the nation's ability to grow its own food and fiber. It makes a positive contribution to the nation's balance of trade, and its farmers are efficient users of water. Therefore, the Coalition will continue with its messages to ensure that water supplies for agriculture are preserved while finding means of increasing water supplies for environmental, urban and recreational uses.

**INSTITUTIONAL FRAMEWORK AND CHALLENGES IN MANAGEMENT
OF AGRICULTURAL WATER USE IN SOUTH FLORIDA**

Vilma Horinkova¹

ABSTRACT

The institutional framework for management of water use and protection of water and related resources in Florida developed as a result of rapid population growth, industrial advancement and agricultural expansion during the second half of this century. The South Florida Water Management District with an area of 17,930 square miles (44,030 square kilometers) is the largest of five state water management districts established by the Water Resources Act in 1972.

South Florida's tremendous growth results in a continuous need to balance demands among water users. Increasing demands create impact on water resources and the environment. The holistic approach to preservation and restoration of Florida's ecosystems and protection of water supplies led to legal and policy actions for protecting areas such as Lake Okeechobee and the Everglades.

Events affecting water management strategies include the passage of the 1987 Surface Water Improvement and Management Act and the settlement of a federal lawsuit against the State of Florida and the South Florida Water Management District for an alleged pollution of the Everglades. These events provided the impetus for the Marjory Stoneman Douglas Everglades Protection Act.

Solutions to water resources related problems are complex. Florida's agriculture remains in competition for water with the urban sector and the environment. About 1.2 million acres (3 million hectares) of agricultural land are irrigated and the population growth pressures create a potential for impacting the agricultural industry. Farmers are encouraged to adopt the most efficient irrigation methods and apply best management practices. The South Florida Water Management District cooperates with the agricultural community on programs for conserving water and related resources.

¹ Senior Civil Engineer, South Florida Water Management District, 301 Gun Club Road, West Palm Beach, Florida 33406

INTRODUCTION

Geography and Hydrology

Florida is a peninsula of about 61,083 square miles (150,000 square kilometers), lying between the Atlantic Ocean and Gulf of Mexico. It has the longest tidal coastline of any state in the contiguous United States. Most of Florida is at 45 to 90 feet (15 to 30 meters) above mean sea level (Atlas of Florida, 1992). The north is gently rolling, the south contains more marshes and wetlands. The state is a unique habitat for many plant and wildlife species.

One of the state's principal watersheds lies within the boundary of the South Florida Water Management District (Figure 1). It is the Kissimmee - Everglades area, covering the central and eastern part of the District. Drainage in the upper portion follows a southerly pattern through a chain of lakes to Lake Kissimmee, and further into the lower part through a partially channelized Kissimmee River into Lake Okeechobee.

Lake Okeechobee, the second largest natural fresh water lake in the conterminous United States covers approximately 730 square miles or 1761 square kilometers (Atlas of Florida, 1992). Its water levels are regulated. The regulation schedule was developed jointly by the U.S. Army Corps of Engineers and the South Florida Water Management District. The Lake plays an essential role in flood control, fishing, sports, recreation, and in water supply. Through an extensive network of canals the water flows to the south and southeast to supply adjacent urban communities as well as approximately 855,731 acres (2,114,511 hectares) of agricultural lands (Soil Subsidence Study, 1987). The largest (603,546 acres) contiguous piece of agricultural land serviced by the Lake lies immediately south of it and is known as the Everglades Agricultural Area (EAA).

At times of drought Lake Okeechobee serves as a back up water supply for South Florida lower east coast communities. The water storage and conveyance function is very important for recharging the potable water wellfields and for mitigation of salt water intrusion impacts. During the critical water supply periods the Lake's water can also be delivered to the Everglades National Park, a natural system of 1,416,450 acres (566,580 hectares) of wetlands and marshes containing a unique wildlife (Hall, 1991).

Ground water: In South Florida there are several

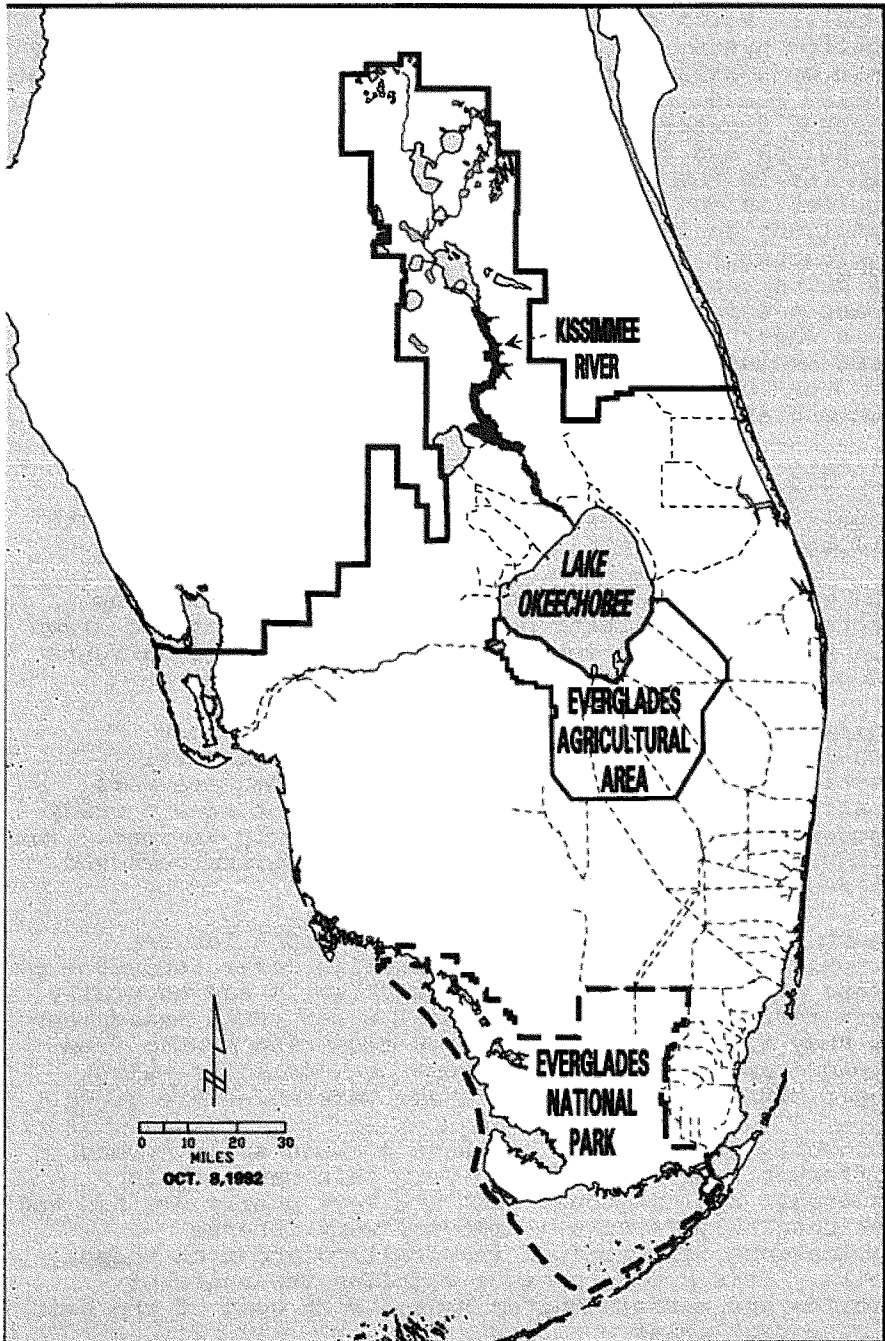

aquifers which are regionally important as a water supply. North of Lake Okeechobee are the surficial aquifer system and the Floridan aquifer, both primarily used by agriculture. The Floridan aquifer underlies the entire state. In South Florida the Floridan is the deepest aquifer and generally has a high concentration of solids and chlorides. On the east coast the main aquifer is the Biscayne, probably the most prolific aquifer in the world. The Biscayne aquifer is an excellent source of water for both the urban and agricultural sector, however, because of its lithology, is quite susceptible to contamination. On the west coast a complex multi-aquifer system is primarily used as a water supply; some of the shallower aquifers are used exclusively for potable water, so that agriculture or other uses must tap the deeper aquifers with higher concentration of solids and salts.

Climate: The climate is humid and warm, reflecting both the temperate and subtropical zones characteristics. Annual average rainfall is about 55 inches (about 1400 millimeters).

The weather with its mild winters is a contributing factor to agricultural development. Crops can be grown all year round and in some cases two to three harvests in one year are feasible.

Soils: Soils in South Florida vary locally but generally are sandy and do not have high natural fertility. The soils in the central ridge are well drained as opposed to the majority of the area's sandy Spodosoils which are poorly to very poorly drained. The sandy soils are used for all types of agriculture and citrus production.

South of Lake Okeechobee lies the world's largest deposit of organic soils - Histosoils (over 600,000 acres or 240,000 hectares). These soils are naturally very fertile and require careful water table management as they are prone to subsidence resulting mostly from biological oxidation. On these organic soils mainly sugar cane, sweet corn, rice and vegetables are grown.

Southerly and easterly of these organic soils extend different types of marl and very thin sandy soils underlain by limestone; both are very poorly drained and not naturally fertile. However, very intense agriculture is practiced in localized areas on these soils. This area's produce supplies the state of Florida and eastern United States with some of the best winter vegetables.

Along the coastline and in the southern tip of Florida the majority of soils are tidal marshes and swamps, primarily used for recreation and wildlife.

HISTORICAL DEVELOPMENT

South Florida Water Management District

The agency's evolution: The need to respond to South Florida's subtropical extremes - flood and drought - led initially to Congressional creation of the Central and Southern Florida Project in 1948 for flood control and other purposes (Huser, 1989). The following year the Florida Legislature created the Central and Southern Flood Control District (FCD) for purpose of sponsoring the federal project and to provide flood protection for farm lands and urban areas. The FCD was a successor to regionally important drainage and reclamation districts - the Everglades Drainage and the Okeechobee Flood Control District, established in 1913 and, respectively, in 1929.

In 1972 the Florida Water Resources Act established five regional water management agencies (Figure 2). At that time the responsibility of the FCD expanded mainly by regulatory powers. In 1976 the FCD was renamed the South Florida Water Management District (District). Its mission further evolved along with the changing water needs and increased environmental awareness. Today the District is a multi-faceted agency playing a primary role in flood protection, water supply planning, protection of water quality, and environmental enhancement in south central Florida.

The District's boundaries are based on natural hydrogeologic basins rather than political (county) limits to allow for effective planning and management (South Florida Water Management District Facts & Figures, 1991). South Florida's immense growth results in a continuous need to balance demands among water users and safeguarding of a healthy environment. With a population of over five million people concentrated along the coasts and agricultural expansion further to the south, the District has to evaluate and balance water use demands which, if unregulated, may regionally cause adverse impacts on water resources and the environment. These impacts include salt water intrusion, ground and surface water quality deterioration, eutrophication of lakes, and impacts on wildlife.

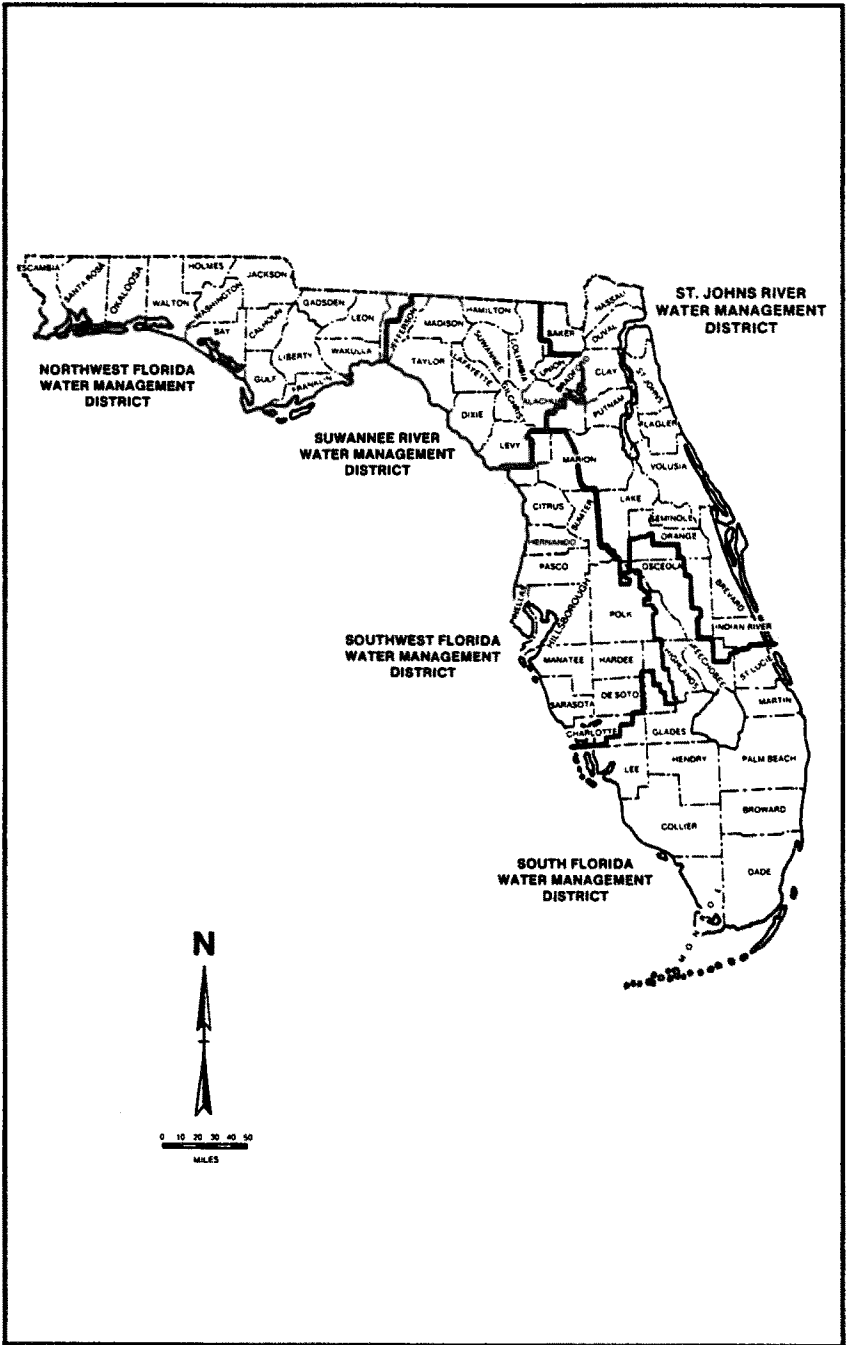

FIGURE 2. Water Management Districts of Florida.

Funding: The agency is faced with an enormous responsibility of preventing damages from floods, soil erosion, excessive drainage and planning for future water supply for public benefit. The budget is funded through a variety of sources, with property taxes as a main source. The District as an independent taxing district is levying its own taxes. The millage has a cap set by the Legislature. Besides the ad valorem taxes and other sources, some monies are derived from fees for consumptive use permits. Every agricultural operation is required to apply for a consumptive/water use permit as well as a well permit. The District charges different fees for these permits, depending on their classification by the water source, type of use and method of withdrawal. There are no charges to the grower for the amount of water used on a farm.

FLORIDA WATER LAW

Florida Water Law Prior to 1972

Prior to the adoption of the Water Resources Act of 1972 Florida was considered a common law riparian state. Riparian owners were entitled to make reasonable water withdrawals for use on their lands. Such system can be viable in a state where water is in plentiful supply or demand is low.

When Florida started to grow it became apparent that the riparian/reasonable water right system would become unmanageable for the policy makers. Additionally, the inherent uncertainty of such system tended to prevent investing in water dependent development and moreover, the system offered no means of protecting the Florida's fragile environment.

The Florida Water Resources Act of 1972

Florida began to address shortcomings of the common law water rights system with the creation of the Florida Water Resources study commission in 1955. The work of the Commission led to adoption of the Water Resources Act of 1957. In 1972 the Legislature adopted the present Florida Water Resources Act which has been codified in Chapter 373, Florida Statutes. This is the primary statute implemented by the District.

The Florida water rights system of today is a blend of the prior appropriation and the doctrine of reasonable use. It provides a certainty to the user by means of holding a permit. It also appears to be more flexible

in assuring a benefit to the public, because by making permits periodically expire, it allows the re-evaluation of each particular use in light of changing conditions.

Water Use Permitting

It is the policy of the District to control all water uses, including uses of water from raw supply to re-use of reclaimed water, within its boundaries. The whole process is driven by Florida Statutes, Chapter 373, which was enacted in 1972. Prior to this date the District's regulatory activity consisted of issuance of permits for the utilization of District rights of way. The District began implementation of Chapter 373 in 1974 by initiating water use and surface water regulatory management programs.

Up until 1975, surface water management reviews consisted of both drainage and water use from surface water sources. Thereafter, review of applications for water use from ground water sources was started. Basin boundaries were created for agricultural water use applications, thus enabling the District to designate one expiration date for all permits within a basin. Throughout the years, substantial changes have been made in the technical basis for water use allocations.

In the early years, emphasis was placed on the reasonable and beneficial needs. During the past few years, water quality impacts, such as salt water intrusion and environmental damage, and impacts on the resource itself, have become increasingly significant in determining the allocable water. The District further established low flows and levels for surface water bodies to be incorporated in the water use allocation process through regulation of intake levels. In 1984 the passage of the Warren S. Henderson Wetlands Protection Act provided authority to protect wetlands and the District designed specific criteria for evaluation of uses and their impact on wetlands.

The District is periodically examining some of the underlying assumptions in determining reasonable and beneficial allocations for agricultural uses. These analyses are based on social/economic impacts and on water shortage/drought management.

LAND AND WATER MANAGEMENT DEVELOPMENT

Factors of Growth

Florida has always welcomed growth. Already in the beginning of this century the pleasant weather attracted developers, tourists and settlers. In the second half of this century a rapid development was marked, especially by the southern half of the state.

The weather in Florida goes through cycles of wet and dry years. Several major hurricanes in the early 1900s caused catastrophic floods and damages to farmland. Almost 3000 lives were lost. For protection of lands against floods, many canals were dug and levees constructed in the beginning of the century.

In 1930 the Corps of Engineers was authorized to control the Lake Okeechobee basin and construct levees around the Lake to reduce damage from overflowing. In the fifties several large drainage canals were dug to equal a total of 1,120 miles (700 kilometers).

During the sixties, in order to be developed, more land was drained, ditches constructed, and levees built. By the year 1982 in south Florida there were total of 1,664 miles (1,040 kilometers) of canals and 1,416 miles (885 kilometers) of levees (Huser, 1989). Agriculture was booming. More field crops and vegetables were grown on the drained lands. Additional lands were brought into citriculture. The cattle industry started to flourish, primarily in the south central plains. The land around and south of Lake Okeechobee containing rich organic soils was cultivated and plantings in sugar cane and vegetables increased. South of Lake Okeechobee several large pumping stations were built to protect this farm land from flooding.

Agriculture in Competition for Water

With the establishment of the National Aeronautics and Space Administration (NASA) complex on Cape Canaveral in the late sixties and with the founding of Walt Disney World in the early seventies, population growth increased in Central Florida. At that time the coastal areas became more densely populated, and agriculture was gradually entering into a competition for water with the urban land uses.

During the seventies and the eighties large cropped areas requiring large pumpages of ground water had to shift more inland and to the south due to increasing

urban pressures. The land farmed allowed, however, a greater degree of recharge after the rain than the mostly impervious urban areas. Due to the higher water demand by coastal development salt water intrusion on both coasts presented an eminent danger unless better management and protection of water resources was instituted.

PLANNING FOR WATER MANAGEMENT IN FLORIDA

Planned Development

Prior to the eighties, development was not planned or controlled. Politics had some impact, but it was becoming obvious that decisions on how to use the available resources must be based on a technical and scientific basis. If the development continued in the same pattern and speed, South Florida would end up being a few islands of native habitat surrounded by urban sprawl and intense agriculture, with tremendous water supply problems.

It was not until the mid eighties that the role of the state water management districts was examined as it relates to the state's planning and growth management scheme. The districts' activities are in general guided by the State Water Use Plan. More consistency was brought into the planning and permitting process by assuring correlation of a proposed land and water use activity with local comprehensive planning in light of the "Florida State Comprehensive Planning Act of 1972" and the "Growth Management Act of 1985".

District's Statutory Framework

The statutory framework in which the state water management districts operate is very complex. While the District as a regional agency is primarily regulating water usage, surface water management, and the use of wetlands in proposed developments, there are other agencies and units of government which exercise water management jurisdiction on federal, state, and local level.

The Environmental Protection Agency (EPA) and the U.S. Army Corps of Engineers are the most significant agencies at the federal level in regard to any land development. The most important on the state level are the Florida Department of Environmental Regulation (FDER or DER), the Florida Department of Community Affairs, and the state's Regional Planning Councils. More

recently, local units of government have been important players in this process in the context of comprehensive planning.

In order to describe the role of the water management districts in regard to local plan compliance and in view of determining a course of action for implementation of resource planning and management approach, different pieces of legislature governing land use planning and water resources development would have to be described.

In 1982 the DER adopted a general water policy. The policy is set forth at Chapter 17-40, Florida Administrative Code (F.A.C.). Each water management district is subject to the water policy because it became a part of the DER's 1986 State Water Use Plan. Recent amendments to the state's water policy require each water management district to produce its own agency plan to implement the policies of the State Water Use Plan. All water supply plans should be completed by November 1994, and updated every five years thereafter.

The DER's work, as it relates to agriculture, is mainly focused on ground water quality in dredge and fill operations, hazardous waste disposal, wetlands, and Best Management Practices under FDER Dairy Rule. The DER's responsibility in jurisdiction of wetlands was redefined in 1984 by the State Warren S. Henderson Wetlands Protection Act.

Dredge and fill permitting jurisdiction by the Corps of Engineers was further expanded in the mid eighties, in permitting into isolated wetlands and mitigation for any proposed wetland impact.

CHALLENGES IN MANAGING WATER AND RELATED RESOURCES

Environmental Impacts

Traditionally, water quantity and quality problems related to agricultural water use and irrigation, were treated separately, mainly because of political, economic, social and legal factors. During the eighties it became obvious that drainage and irrigation aspects of water management in agriculture must be evaluated jointly and that existing water management practices in agriculture could not be sustained indefinitely, because they may result in serious impacts on the environment. Water managers needed to focus more on improvements to surface water management systems and water quality problems on a regional basis.

While the environmental awareness was increasing, some adverse impacts related to water quality and degradation of natural environment became obvious. Certain surface water management practices in agriculture were questionable. Specific impacts such as altered hydroperiods and water quality problems were evident in the Everglades National Park. These problems were magnified during the eighties when Florida experienced severe droughts.

Backpumping of drainage water from canals into Lake Okeechobee during the eighties as a strategy for water storage became very controversial because the water was rich in phosphorus and would speed up eutrophication of the lake.

SWIM Plans

As a result of passage of the Surface Water Improvement and Management (SWIM) Act in 1987, the water management districts were required to prepare SWIM plans for priority water bodies as identified by the Act. The South Florida Water Management District designed four regional SWIM plans for improvement of water quality. These plans represent a major breakthrough in management of water and natural resources related to water quality and should be implemented during the nineties.

The Lake Okeechobee and the Everglades SWIM plans are two plans which seem to have an economic impact on different types of agricultural enterprise in specific regions and are discussed here further.

Lake Okeechobee SWIM Plan: Historically, management of the lake has been largely a function of balancing water supply and flood protection needs against environmental requirements. The lake, as a source of inflow water for the Everglades and a home for a number of rare and endangered species, constituted a subject for several studies linked to the water quality. Protection of the lake's extensive littoral zone community became an important environmental resource issue. Excessive nutrient loading and declining water quality in the eighties impacted the fish by stimulating nuisance growth of algae and altering species composition of the lake's phytoplankton.

In 1985 the Lake Okeechobee Technical Advisory Committee was established to evaluate options and prepare recommendations for preserving the lake's life and productivity, and improving its water quality. The work proposed by the Committee created a basis for the SWIM

Plan. The planning area for the Lake Okeechobee SWIM plan was defined as consisting of the major direct tributary basins to the lake.

The 1989 SWIM Plan (an interim plan) focused primarily on implementation of a regulatory and enforcement compliance phosphorus control program within the tributaries. Since that time the District has moved forward with developing rules, permitting procedures and water quality monitoring plans.

In 1987 the FDER enacted the "Dairy Rule" (Chapter 17-6, Florida Administrative Code) which required that all dairy operations within the Lake Okeechobee Basin and its tributaries implement Best Management Practices (BMPs) for the purpose of reducing phosphorus inputs into the lake. Total of 49 dairies came under this Rule. Each farm was required to develop site-specific management plan providing for the collection, storage, and disposal of waste water from high intensity use areas during a 25-year, 24-hour storm event (Surface Water Improvement and Management Plan Update for Lake Okeechobee, 1992). All affected dairies were required to submit construction permit applications along with the BMPs design.

The District provided assistance by hiring two consulting firms to prepare plans for 16 dairies. Best Management Practices included fencing cows away from water courses; collection, containment and treatment of manure and waste water runoff from high intensity areas; crop spray irrigation and land application of waste water, solids and sludge, as well as establishment of buffer zones from natural watercourses. Some critics of the Rule called the BMPs "stringent and experimental" regulation creating financial and psychological hardship.

In 1989 a Dairy Buy-Out program was established, for farmers who were unwilling or unable to comply with the Dairy Rule by implementing BMPs. The state and the District paid up to \$602 per cow, based on heard size from June 1986 to June 1987, to facilitate removal of the animals (Surface Water Improvement Management Plan Update for Lake Okeechobee, 1992). The program applied a deed restriction to the property prohibiting future use as a commercial dairy or concentrated animal feeding operation.

So far, from the 49 dairies in the basin 18 have signed contracts to participate in the Buy-Out program. The remaining active dairies are involved in the

implementation of the Dairy Rule BMPs.

Everglades Restoration/ SWIM Plan: The problems with impacts on the sensitive ecosystem of the Everglades National Park culminated in 1988, when the U.S. Attorney in Miami filed a federal lawsuit against the South Florida Water Management District and the Department of Environmental Regulation alleging pollution of the Park and a Federal Wildlife Refuge by agricultural runoff.

The District prepared a first draft of the SWIM plan for the Everglades in 1989. Discussions between various agencies reviewing the plan were endless. The Governor of Florida and the Justice Department Officials held a press conference in July 1991 and announced a proposed settlement to the Everglades lawsuit. After about two weeks of discussions and deliberations, and much involvement of technical and scientific experts, the settlement was accepted by the Governing Board of the District and finally, in February 1992, formally accepted by a judge.

The Everglades SWIM plan was developed pursuant to the 1987 SWIM Act. Additionally, the 1991 Marjory Stoneman Douglas Everglades Protection Act mandates Everglades restoration and gives the District power to establish a stormwater utility in the EAA for financing a massive cleanup and to condemn lands in the EAA for building filtration marshes.

The settlement of the Everglades lawsuit contains several restoration steps which concentrate on regulatory programs such as maintaining and monitoring water quality. Under the requirements of the settlement the District is required to purchase 34,700 acres of land and construct Stormwater Treatment Areas (STAs), which would filter nutrients (mainly phosphorus) from sugar cane and vegetable farms runoff before it reaches the Everglades (Hazen and Sawyer, 1992).

The proposed area of STAs is currently in some type of agricultural production. In 1991 about 26,000 acres of this area were in sugar cane, approximately 5,000 acres in sod and the remainder in vegetables. Converting this lands from agricultural production to STAs will result in job losses, losses in agricultural production, trade and service industries (Hazen and Sawyer, 1992).

The District hired a consultant to prepare a report on the overall economic impact of the construction of STAs in the EAA area. The report concludes that the project will mean an overall economic increase in jobs, earnings

and sales during the three year construction. So far, the plans for construction of STAs have been under heavy criticism and opposition by the agricultural community.

FLORIDA'S AGRICULTURE IN THE FUTURE

Competition for Water - Challenge

Urbanization continues to place pressure on agricultural development. Throughout the nineties the population in South Florida is projected to grow and agriculture will remain in competition for land and water. Agriculture will continue to be the largest user of fresh water from both ground and surface water sources. In 1991 there are an estimated 2,048,000 irrigated acres (819,000 hectares) in the state of Florida, according to a survey made by the University of Florida's Institute of Food and Agricultural Sciences (1991).

Today's farmers are challenged by compliance with various regulations including the volumes of water they use, irrigation techniques and technology they apply. They also must implement water conservation measures and minimize impacts on the environment by using more sophisticated management practices.

In South Florida, various regional water use regulating policies can definitely create an impact on the economic conditions of a small farmer. Changing international trade policies can produce an economic impact on farmers in Florida as well, especially when there seem to be no alternatives for adapting to the increased competition. In the future, South Florida fruit and vegetable growers will most likely be affected (price drop) by the North America Free Trade Agreement (NAFTA), although the net economic effect for the United States may be positive.

Besides natural phenomena, a combined effect of urbanization pressures, limitations of the fresh water resource ("cheap water") and restrictions on local land development may present additional problems for the sustenance of profitable agriculture in Florida in the future.

Natural Phenomena

While regulation is a certain and predictable factor affecting profitability of agriculture enterprise, nature can play havoc. Droughts, freezes and hurricanes can mean locally total devastation, as happened in August 1992 in the case of Hurricane Andrew (Figure 3).

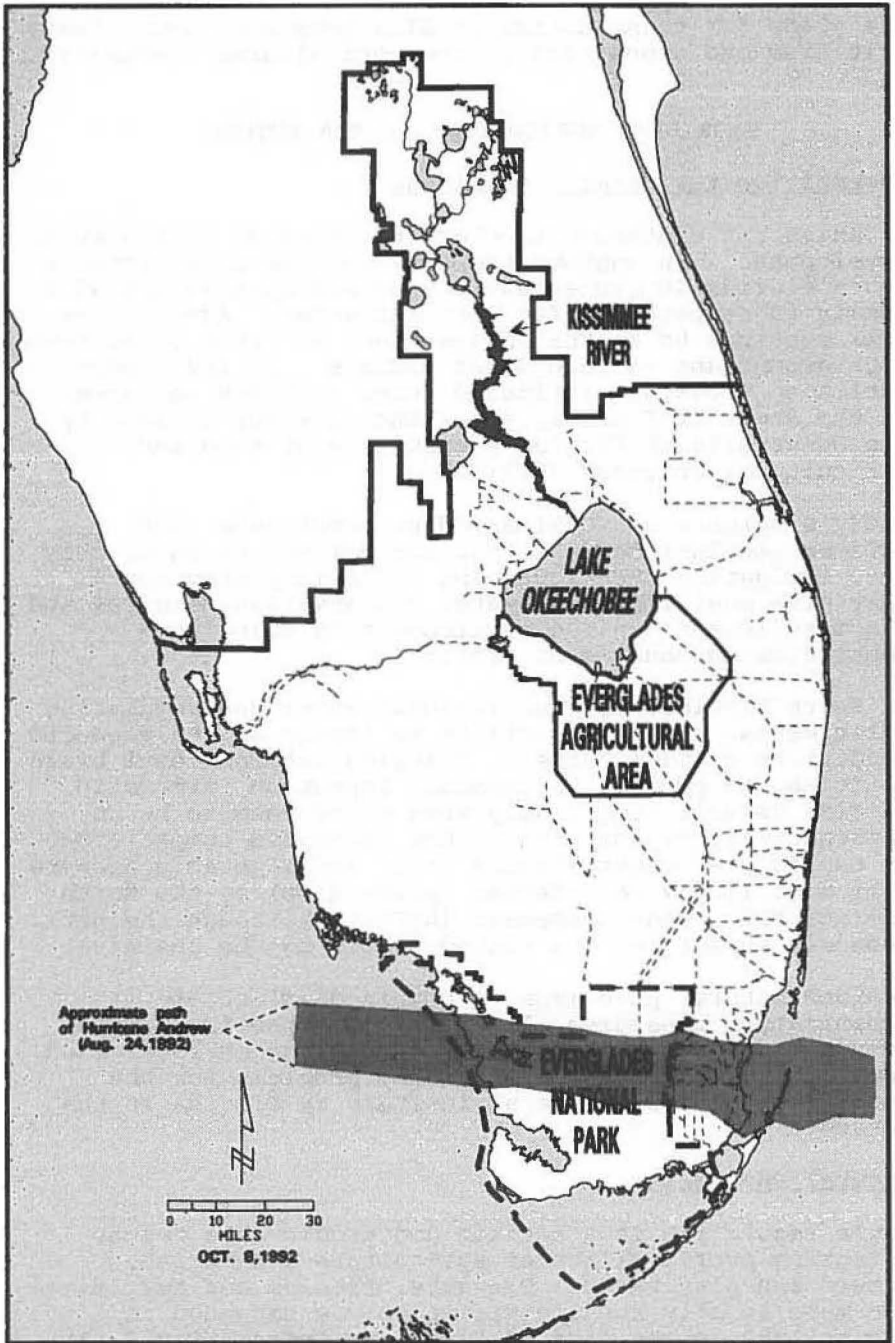

FIGURE 3. The path of Hurricane Andrew, August 1992.

The devastation of the southern Florida fruit, foliage and vegetables was the costliest agricultural disaster in Florida history and second nationally only to the Grain Belt drought of 1988. The 1993 vegetable harvest was partially lost and there is further loss expected from salt water intrusion on 5,200 acres of row crops. Some of the tropical fruit, lime, avocado and mango growers lost their production even beyond the year 1996. The entire estimated agricultural loss in structural damages, destroyed crops, and dead animals totalled approximately \$1.04 billion.

Water Conservation

The water conservation programs and efforts fostered by the South Florida Water Management District through the water use permitting process prompt all growers to use the highest available irrigation technology applicable to their crop/soil conditions and apply the best management practices in the use of the systems and water resources. Recycling of tail water and runoff in seepage irrigation systems is encouraged. Utilization of treated waste water is now proven feasible and profitable, especially in irrigation of citrus groves.

When it is evident that growers operate within the guidelines towards water conservation, they will receive a credit from the District towards their allocation during periods of water shortage/drought management. The District is sponsoring jointly with the Soil Conservation District a Mobile Lab program which helps the growers to check their irrigation system efficiency, and provides them with recommendations for improvements in management.

Farmers and growers are continuously increasing their understanding of the complexity of water management issues. The District through different water resources workshops and funding of agricultural research projects is strengthening the relationship with the agricultural community. The majority of growers is anxious to maintain good communication with the District and help to preserve and protect water and natural resources of South Florida. They realize that issues related to water availability and quality are real, and that there is no room for ostrich-like mentality.

REFERENCES

1. Fernald E. D., 1992. Atlas of Florida.

2. Huser, T., 1989. Into the fifth decade.
3. Messina W. and R.L. Clouser, 1991. U.S. Mexico free trade and Florida agriculture.
4. Hazen and Sawyer, Environmental Engineers and Consultants, 1992. Evaluation of the economic impact from implementing the Marjory Stoneman Douglas Everglades Restoration Act and U.S. versus SFWMD Settlement Agreement.
5. South Florida Water Management District, 1992. Facts and Figures, 1992
6. South Florida Water Management District, 1992. Surface Water Improvement and Management plan update for Lake Okeechobee

TECHNOLOGY TRANSFER LESSONS FROM A U.S. WATER DISTRICT

Douglas Welch¹ and Karen McLaughlin²

ABSTRACT

An interceptor canal will be constructed near the end of eight laterals to collect and transport operational discharge and returned farm deliveries to a reservoir for temporary storage. The water will then be pumped over to an adjacent canal system for delivery. This project is being funded by the Imperial Irrigation District - Metropolitan Water District of Southern California (IID-MWD) Water Conservation Agreement. This paper describes the planning process for the project.

INTRODUCTION

The IID is located at the southern end of California, about 100 miles east of San Diego and 50 miles west of the Colorado River. Colorado River water is conveyed to the IID through the All-American Canal, which was built by the U.S. Bureau of Reclamation in the 1930s. The IID's 1,675 miles of canals, deliver approximately 2.6 million acre-feet of Colorado River water to nearly 490,000 acres of agricultural lands in the Imperial Valley. There are five regulating reservoirs with a combined storage capacity of 1,904 acre-feet situated at strategic locations in the irrigation system. As water is moved through the gravity flow system's 3,228 check structures, a combination of remote and manual gate adjustments are made to maintain the appropriate water level upstream of the check.

The IID and MWD entered into an agreement, in 1988, to conserve 106,110 acre-feet of water. The agreement calls for MWD to pay for the capital, annual direct and indirect costs of various conservation projects that IID will implement over a five-year period.

¹Water Resources Planner, Imperial Irrigation District Imperial, CA

²Senior Engineer, Imperial Irrigation District, Imperial, CA

POTENTIAL FOR WATER CONSERVATION

The lateral interceptor concept was initially conceived in order to reduce operational discharge which occurs at the ends of lateral canals. A canal would be constructed near the end of a group of laterals to collect operational discharge. The water would be stored in a reservoir and then pumped over to an adjacent canal system for delivery. (see figure 1) During the planning process, it was determined that two other sources of water loss, tailwater and excess deep percolation, could be reduced by providing increased delivery flexibility. The increased flexibility would allow farmers to terminate the delivery when the field is sufficiently irrigated.

A certain amount of operational discharge is inevitable in the daily operation and management of a lateral. There are several reasons for this. When a portable pump is being used to irrigate a field, the pump will occasionally break down and the delivery gate will be closed by the irrigator. If the breakdown will only occur for a short period of time, the water will be spilled. Otherwise, the IID will be notified

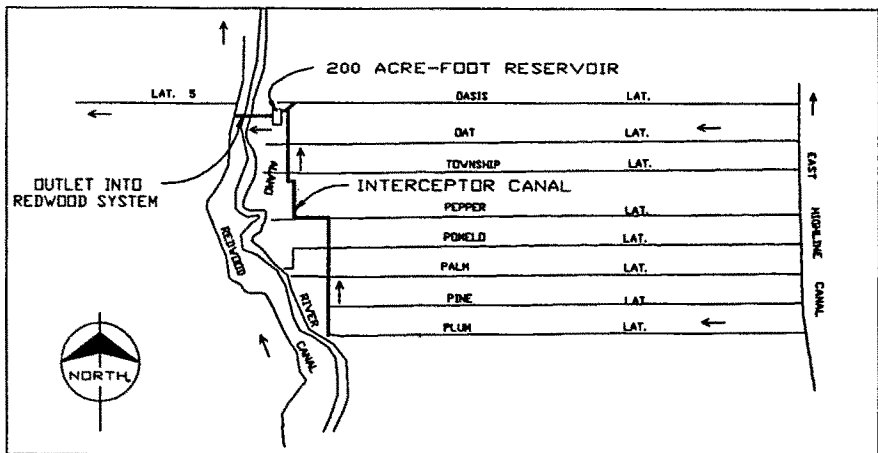

Figure 1 Plum-Oasis Lateral Interceptor

and the appropriate adjustments will be made in the lateral to prevent or reduce operational discharge. Second, as the irrigator irrigates different portions of a field, the back pressure on the delivery gate can

change as he checks the water up at different locations in the farm ditch, resulting in a change in the delivery flow. When the delivery is reduced, by an increase in the backwater on the delivery, the rejected flows are transported downstream and may result in increased operational discharge. Third, a certain amount of water is carriage water. This carriage water is required to fill ponds, allow for seepage and evaporation, and to provide for incidental over deliveries to insure that enough water reaches every delivery being made from the lateral.

Tailwater is water that runs off the end of a field during the normal course of an irrigation. Tailwater is usually discharged into an IID drain. In order to adequately replace soil moisture that has been removed from the field by the process of evapotranspiration, enough opportunity time must be allowed for the irrigation water to infiltrate into the soil. On a sloping field, this means that the stream of water that has advanced down the field must continue to run until the soil moisture in the field is adequately replenished. During this time tailwater occurs. It is difficult to estimate the exact amount of water that will infiltrate into a field during an irrigation. Tailwater in excess of what is needed occurs when the farmer overestimates the amount of water needed. Allowing irrigators to terminate the delivery when the field is sufficiently irrigated will reduce excess tailwater.

Poor distribution uniformity can occur when an irrigator must match the irrigation stream size and set times to match the IID's 24 hour delivery system. The result can be deep percolation in excess of what is required to maintain a favorable salt balance. Allowing irrigators to select stream sizes and set times that are appropriate for the field being irrigated would improve distribution uniformity and reduce excess deep percolation.

PROJECT PLANNING

At the beginning of the planning process for this project, a general planning meeting was held with operations, design, construction and management personnel, to discuss the overall purpose of the project, how operations would be affected, and the data needed for the planning, design and construction of the project. As more data became available, subsequent meetings were held with all the interested

parties to keep them updated and to deal with specific issues. Farmers in the affected area were also contacted to get their ideas. This process insured that all of the affected parties concerns were addressed.

Operational Strategy

The lateral interceptor system will provide increased delivery flexibility to the irrigator, making it possible for the irrigator to irrigate more efficiently. The less restrictions that are placed on the irrigator the more likely it will be that the irrigator will utilize the flexibility to conserve water. The lateral interceptor system will provide the District with the "tools" to allow this flexibility, while maintaining control of the canal operations.

Initially irrigators will be required to request permission to return water to the laterals. The irrigator will be instructed to adjust his delivery gate appropriately or a zanjero (ditch rider) will make the changes. This will allow irrigators and District staff time to acquaint themselves with the intricacies of the lateral interceptor system. During this time, operational procedures to optimize the amount of water conserved by the lateral interceptor system will be determined. An operational procedure manual will be prepared that describes the responsibilities of irrigators and District staff and the new procedures will be instituted.

Interceptor Location

Two alternatives for locating the interceptor were considered: (1) at the end of the laterals; or (2) about two-thirds of the way down the laterals. Locating the interceptor at the end of the laterals would allow farmers to shut off their delivery with very little or no notification. Locating the interceptor about two-thirds of the way down the laterals would allow delivery of a portion of the operational discharge and returned deliveries to the last third of laterals it intercepts, however, locating the interceptor two-thirds of the way down the laterals would make it necessary for farmers downstream of the interceptor to notify the IID in advance of their intended shutoff, to allow the zanjero time to divert the water into the interceptor. The majority of the early shutoffs may occur one hour

or less before the normal shutoff time. The logistics and time involved to notify the zanjero of the need to end the irrigation would probably result in many of the irrigators not making the effort to end the irrigation less than one hour early. This could substantially reduce the amount of water conserved. It was felt that the small advantage of being able to deliver water from the interceptor into the last third of the laterals was outweighed by the potential conservation achievable with very little or no notification.

Interceptor Sizing

The Plum-Oasis Lateral Interceptor is a pilot project designed to study the potential for conserving operational discharge and on-farm losses and to determine the flow conditions to design for in future interceptor systems. Restricting the amount of flexibility in the pilot project could reduce the overall effectiveness of the program. With this in mind, liberal sizing was recommended. The size at the upstream end of the interceptor was set to have the capacity, 90 percent of the time, to allow for the possibility of all deliveries running in the first lateral to be returned. The remaining 10 percent of the time a portion of the returned deliveries will need to be backed out of the lateral and rerouted to one of the reservoirs on the main canal. The size at the downstream end of the interceptor was set to have the capacity, 90 percent of the time, to allow for the possibility of all ending deliveries on the eight laterals to be returned. The remaining 10 percent of the time a portion of the ending deliveries will need to be rerouted to one of the reservoirs on the main canal.

Lateral Canal Sizing

The capacity at the downstream end of some of the laterals will be increased to have the capacity, 90 percent of the time, to allow for the possibility of all deliveries running in a lateral to be returned without notice. The remaining 10 percent of the time notification will be required on a portion of the deliveries, so that the zanjero can cut the water out at the head of the lateral, prior to the delivery gate being closed.

Lateral Discharge to Interceptor

Automated gates will be installed to regulate the discharge from the laterals into the interceptor. If the capacity of the reach of the interceptor immediately downstream of the lateral discharge would be exceeded by discharging additional water into the interceptor, the automated gate will divert the excess water to the lateral spill. If this occurs, an alarm will be activated at operating headquarters and the inflow into the lateral will be reduced, if warranted. The flow rate and duration of any operational discharge will be recorded and taken into consideration when sizing future interceptor systems. It is believed that operational discharge to the drains will be minimal, due to the liberal capacity of the interceptor.

Reservoir and Pump Sizing

For the purposes of analysis a maximum scenario where 50 percent of the ending deliveries would shut off two hours early and 50 percent of the ending deliveries would shut off four hours early was assumed. In addition, two acre-feet of operational discharge from each of the eight laterals was assumed daily. A computer model was prepared to simulate the daily change in reservoir storage under these assumed conditions. The model calculates the daily amount of water to pump into the Redwood Canal, taking into consideration the demand on the Redwood Canal, and the volume of water that will be in the reservoir at the end of the day. The model demonstrated that a 100 acre-foot reservoir would allow all of the returned deliveries on 92 percent of the operating days to flow into the reservoir. During periods of high flows (eight percent of the time) some of the returned deliveries would need to be backed out of the lateral.

The model only considers the amount of water in storage at the end of the day. The hourly changes in storage must also be considered. A second model was prepared to model the hourly flows and reservoir water levels. A maximum scenario where 165 cfs is discharged for four hours, one cfs per lateral continues to discharge for the remaining 20 hours and 30 cfs is being pumped into the Redwood Canal, during the 24 hour period, was simulated. An additional 48 acre-feet storage capacity would be required.

Finally, an additional 52 acre-feet of storage, for a total of 200 acre-feet, was added to allow for possible contingencies such as: the addition of other laterals to the interceptor system, increased flexibility in operating the reservoir, and any changes in on-farm irrigation practices or cropping patterns that may increase the amount of water returned.

The computer model used for reservoir sizing was also used to determine the minimum pumping capacity. The model indicated that the minimum pumping capacity should be 25 cfs. A capacity of 50 cfs was selected to provide added flexibility for the operation of the reservoir.

Modification of Check Structures

When a delivery is returned, it will flow down the lateral into the interceptor. With the present manually operated checks, it would be necessary for the zanjero to manually adjust each of the affected checks each time a farmer returned a delivery. Besides the increased labor requirement, advance notice of each delivery return would be required. Modification of the check will therefore be required. A study was initiated to compare three alternative modifications: two variations of a long-crested weir; a drop-leaf gate regulated by a programmable logic controller; and an Amil Constant Upstream Level Gate. The annualized costs of the three alternatives were within \$162 dollars of each other. The long-crested weirs were found to have the least things that could go wrong with them, however, the three day installation time (1 day for the others) would cause unacceptable disruptions in canal operations. The Amil gate had problems with sticking, which resulted in the lateral overtopping several times. The drop-leaf gate provided the best water level control and will be installed on three of the eight laterals where the operation and maintenance costs will be observed for a period of time. The drop-leaf gates will be installed on the other five laterals if the gate's operation and maintenance prove satisfactory. A method for pre-fabricating and installing the long-crested weirs in one day will also be studied.

Estimate of Cost and Conservation

The estimated capital cost for the interceptor system is \$8.1 million dollars and the annual operation and

maintenance costs are estimated to be \$136,000 dollars. The amount of water that is estimated will be conserved by the project annually is 8,318 acre-feet. Assuming a 35 year project life and eight percent interest, the cost of the conserved water is about \$100 per acre-foot.

SUMMARY

An interceptor canal will be constructed near the end of eight laterals to collect and transport operational discharge and returned farm deliveries to a reservoir for temporary storage. The water will then be pumped over to an adjacent canal system for delivery. Throughout the planning process, input from operations, design, construction, management and farmers was solicited to insure that the planning process addressed all the areas of concern for all parties. The interceptor is a pilot project designed to study the potential for conserving operational discharge and on-farm losses and to determine the flow conditions to design for in future interceptors. Liberal sizing of the interceptor, reservoir and pumps was recommended to reduce the amount of notification that will be required of irrigators. Automated drop-leaf gates will be installed on the checks to control the water level upstream of the checks. The lateral interceptor system will provide increased delivery flexibility to the irrigator, making it possible for the irrigator to irrigate more efficiently. The less restrictions that are placed on the irrigator the more likely it will be that the irrigator will utilize the flexibility to conserve water.

Appendix I - SI unit conversions

1 acre	=	0.40486 ha
1 mile	=	1.6093 km
1 acre-foot	=	1233.4 m ³
1 cfs	=	0.02832 m ³ /sec

MANAGEMENT OF WATER CONSERVATION THROUGH IRRIGATION SYSTEM MODERNIZATION AND REHABILITATION

A.K. Dimmitt¹, K.I. McLaughlin²,
F.Z. Kamand³, and D.G. Welch⁴

ABSTRACT

A landmark water conservation agreement became effective in December 1989 between the Metropolitan Water District of Southern California and Imperial Irrigation District to conserve 106,110 acre-feet of water annually through the modernization and rehabilitation of Imperial Irrigation District's irrigation distribution system. The agreement provides for 17 projects (Program) to be planned, designed and implemented over a five year period, ending in 1995, plus verifying project accomplishments both from a cost and volume of water conserved standpoint. Management of the planning, design and implementation process, the process of verifying project accomplishments and three case studies demonstrating the various planning approaches used are presented.

INTRODUCTION

The Imperial Irrigation District (IID) distributes between 2.5 and 3 million acre-feet of Colorado River water annually through the All American Canal primarily for gravity irrigation of nearly 500,000 acres of farm land in the Imperial Valley in southeastern California. All agricultural drainage water flows northerly by gravity to the Salton Sea. During the mid-1980s, IID determined that up to 358,000 acre-feet of water could be conserved annually by the implementation of water conservation projects without negative impacts to agricultural production and that 250,000 acre-feet of this

1,3 Principal Engineer and Associate Engineer,
respectively, Metropolitan Water District
of Southern California, 1111 Sunset Blvd,
P.O. Box 54153, Los Angeles, CA 90054

2,4 Senior Engineer and Water Resources Planner,
respectively, Imperial Irrigation District,
P.O. Box 937, Imperial, CA 92251

conserved water could be made available to lower priority users of Colorado River water in California. The Metropolitan Water District of Southern California (MWD) normally distributes over two million acre-feet of Colorado River water and State Water Project water annually to a service area of over 5,100 square miles in six Southern California counties in which over 15 million people reside. Faced with current and projected water supply shortages in its service area, MWD has been aggressively pursuing various programs aimed at improving the adequacy of its water supplies. One such program involves improving the efficiency of agricultural water use outside the MWD service area through economic incentives and making the conserved water available to MWD.

A landmark agreement (Agreement) became effective in December 1989 between MWD and IID which provides for the implementation by IID of 17 projects estimated to conserve 106,110 acre-feet of water annually by 1995. MWD is funding all the costs of 15 projects of the program and, in return will have available additional water from the Colorado River for diversion through its Colorado River Aqueduct. Figure 1 shows the service areas of IID and MWD, the Colorado River, and the MWD Colorado River Aqueduct.

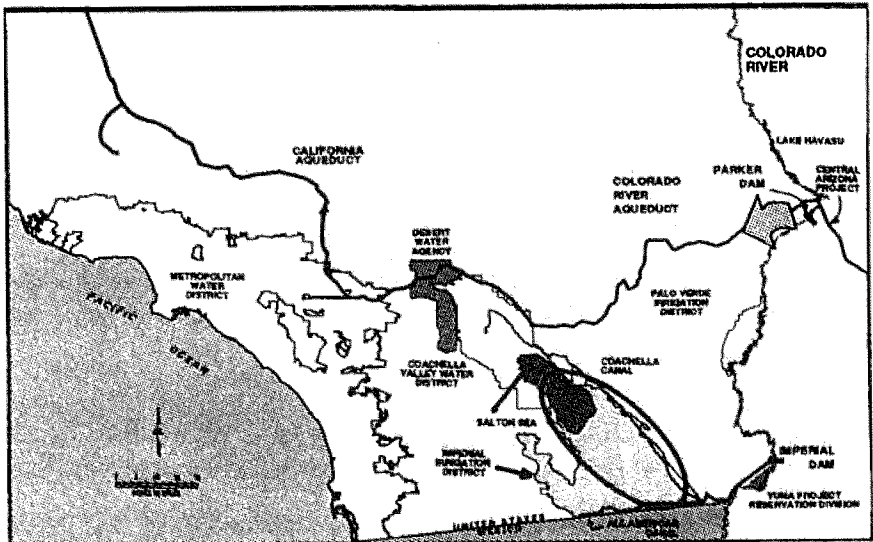

Figure 1: IID and MWD Service Areas.

ORGANIZATION FOR MANAGEMENT

As a means of managing the Program to provide prompt and orderly review and approval of planning activities as well as design and construction, a Program Coordinating Committee (PCC) consisting of three professional engineers competent and experienced in the agricultural and civil engineering fields was established. The PCC is composed of one representative from IID, one representative from MWD, and one representative selected by both parties to the Agreement.

Additionally, to oversee and direct the activities to verify the quantity of water conserved by the Program, a Water Conservation Measurement Committee (WCMC) was established. The WCMC is composed of the three PCC members plus one representative each from the Coachella Valley Water District (CVWD) and the Palo Verde Irrigation District (PVID). CVWD and PVID hold intervening rights to use of Colorado River water in California, hence their interest in verifying the amount of water conserved by the projects. The WCMC is assisted in carrying out its responsibilities by consultants specialized in water resources engineering.

The primary planning, design, and construction management activities are carried out by the IID staff supported, as required, by consultants. The Program, with estimated capital expenditures of \$97.3 million and annual direct costs of \$2.6 million (all in 1988 dollars), is a major effort requiring a substantial amount of planning, much of which is being conducted concurrently with design and construction activities in order to meet the schedule specified in the Agreement. As IID had only the necessary technical staff to carry out its normal water delivery operations, reorganization and additional staff were required to meet this challenge.

The reorganization and additional staffing were accomplished through the hiring of professional and technical personnel, sometimes on a part-time basis, plus engaging consultants to provide specialized skills as required. In hiring consultants, the effort was focused on engaging specific professionals within firms who were known to have the expertise needed.

THREE PLANNING CASE STUDIES

Three case studies are presented to demonstrate the variety of management/planning approaches used. In addition to the basic planning documents, the development of implementation plans necessary to carry out verification activities including field monitoring sites, data gathering and analysis, and presentation of results and recommendations to the PCC and WCMC were required. The first case, canal concrete lining, had to begin quickly due to time constraints. IID staff had considerable experience in concrete lining, so construction began almost immediately after the Agreement became effective. On-Farm Water Management, the second example, was dependent on direct farmer involvement in the planning process. The third example, Plum-Oasis Lateral Interceptor, required extensive planning, part of which took place concurrently with design and construction.

Canal Concrete Lining Project

In January 1990, only three weeks after the first Program funds were deposited, construction began on lining existing earthen canals. The decision to proceed in this manner was based primarily on the initial estimate that 265 miles of lined canals were needed to conserve 29,150 acre-feet of water as specified by the Agreement. This would be a major effort, both from a cost and water conservation standpoint. Additionally, IID staff had considerable experience designing and constructing concrete lined canals; therefore, all the design/construction guidelines and criteria were available and were put immediately to the task at hand.

The verification process caught up with the design and construction effort about 18 months after project implementation began and approximately 110 miles of canals had been lined. Preliminary results indicated a potentially lower volume of conserved water per mile of canal than originally estimated, and the Agreement cost per acre-foot of water was now being exceeded. The PCC agreed to put this project on hold while IID staff developed preliminary procedures to evaluate the amount of water conserved. This planning was accomplished in a 45-day period resulting in a revised strategy to line an additional 26 miles of canals in 1992. A consultant was engaged

to continue this effort through a detailed evaluation of all operating considerations including flow management losses resulting from required daily changes in delivery locations and flow rates, seepage losses during and after the start-up of canal operations, losses during the canal operation shutdown period and evaporation losses. Taking into account these factors, a lateral conveyance loss computer simulation model, Lateral Probe, was developed and is being used to screen remaining earthen canals in IID for potential concrete lining under this project. Additionally, further refinement of the model for use in the verification process is underway.

On-Farm Water Management

The on-farm irrigation water management projects include implementation of tailwater pumpback systems, drip irrigation systems, level basin irrigation, and improving irrigation management skills of farmers. For planning purposes, some field data and information for on-farm projects were available from previous studies conducted by IID. However, successful implementation of the projects required farmers' direct involvement and cooperation. Farmers, through existing committees or newly established ones, were involved from the start. They have and will continue to play an active role in the decision making and formulation of the scope, magnitude and administration of this project.

Six tailwater pumpback systems were installed in 1991 and 12 will be installed in 1992. Implementation of four drip systems was completed and a field irrigation laboratory should be fully operational by late 1992. Plans to participate in three additional drip systems have been completed and one of these systems should be operational by October-November 1992. Field data, which will form the basis for future systems, is being collected for verification of water conservation as well as annual direct costs associated with each system. In order to address farmers' concerns regarding potential effects on crop yields, soil salinity monitoring is an integral part of the projects. This planning and implementation process for on-farm projects is proving to be an effective, dynamic process and has laid the groundwork for successfully completing the first Agreement projects as well as any possible future agreements.

Plum-Oasis Lateral Interceptor

The Plum-Oasis Lateral Interceptor (Interceptor), first of its kind for IID, consists of an open channel which will collect and transport operational discharge and returned farm delivery water from the ends of several laterals to a storage reservoir for use in another part of the distribution system (see Figure 2).

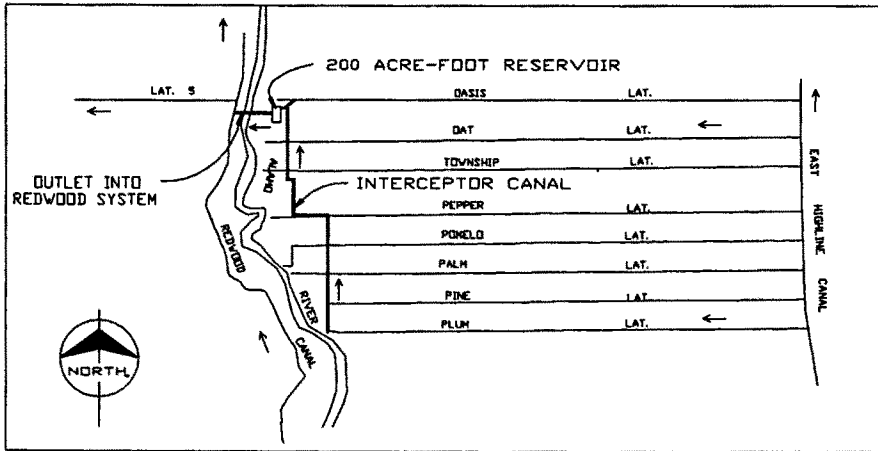

Figure 2. Plum-Oasis Lateral Interceptor.

Planning for the Interceptor was performed by IID staff and began in January 1990. The basic goals of the planning effort were to determine the specific location of the channel and storage reservoir, and to develop criteria for interceptor channel and reservoir sizing. The primary criteria for locating the Interceptor included: 1) locating the system as close as possible to a portion of the distribution system where the collected water could be used, and 2) water demand in the receiving portion of the distribution system had to equal or exceed the anticipated quantity of water to be captured. Developing criteria for interceptor channel and reservoir sizing was based on estimating inflow to the Interceptor. The inflow estimate would also be used to determine whether an area met the supply versus demand criteria previously mentioned.

Inflow to the Interceptor will be composed of two components: 1) operational discharge (incidental flow fluctuations and carriage water which is required to fill ponds and insure that enough water reaches every delivery in IID's gravity system), and 2) water generated by providing greater water delivery shutoff flexibility to farmers. At present, water is ordered for 24-hour or 12-hour time periods. A farmer may request that an order be terminated early; however, this can be done only if IID personnel are available to close the delivery gate and adjust the canal heading so that the water does not continue to flow down the lateral and result in spill. With the Interceptor in place, farmers may be given the freedom to terminate deliveries ahead of schedule without having to notify IID in advance.

Estimating the quantity of operational discharge was relatively straightforward because operational discharge data collection began on the Plum through Oasis Laterals in June 1988. Thus, about 1.5 years of operational discharge flow records were available for project planning. However, the quantity of water that would be produced by allowing farmers to terminate their deliveries early had to be estimated using actual delivery records combined with assumptions as to how many deliveries would be terminated early and how far in advance termination would take place. Liberal sizing criteria were recommended because the Interceptor will be used to determine the potential for water conservation by allowing unrestricted, early termination of deliveries. Further restriction on the size of the Interceptor would necessitate lesser operational flexibility which could reduce the effectiveness of the project.

Providing additional flexibility will also require replacing the regularly operated check gates in the laterals with control structures which will allow flow changes to pass downstream with minimal impact to deliveries in progress. Determining the type of structure to be used became a study in itself, which took place after the planning for the interceptor channel and storage reservoir were complete. Thus, design of the interceptor channel and reservoir was started while planning for the new gate structures was in progress.

A total of three lateral interceptor systems, including the Plum-Oasis Lateral Interceptor, are included in the Agreement. Construction of the Plum-Oasis Lateral Interceptor began in March 1992. As part of this effort an Operations Study is being planned to evaluate the various potential operating scenarios such as: 1) Entire lateral automated; 2) Lateral heading and connection to interceptor canal automated but not canal checks; and 3) Lateral automated with exception of the heading. To facilitate this Study only three of the eight laterals had all the drop-leaf gates installed, at the check structures, during this phase of project construction. The Study is expected to provide practical, field results for finalizing the Plum-Oasis Lateral Interceptor configuration. Experience gained from this project will be used for planning and design of the remaining two interceptor projects to be constructed in 1993 and 1994.

SUMMARY

A landmark agreement became effective in December 1989 between MWD and IID which provides for the implementation by IID of 17 projects which will conserve an estimated 106,110 acre-feet annually by 1995. MWD is funding all the costs of 15 projects of the program and, in return will have available additional water from the Colorado River for diversion through its aqueduct. The primary planning activities are carried out by the IID staff supported, as required, by consultants. A Program Coordinating Committee was established to provide review and approval of planning, design, and construction activities. A Water Conservation Measurement Committee was established to oversee and direct activities to verify the quantity of water conserved by the program.

Three case studies demonstrate the variety of management/planning approaches used. Construction of concrete lined canals began almost immediately after the Agreement became effective. However, 18 months after project implementation, new information from water conservation verification activities caused a temporary slowdown while the strategy for selecting canal sections for lining was revised. On-farm irrigation water management projects required farmers' direct involvement and cooperation through

existing committees or newly established ones. They played an active role in the decision making and formulation of the scope, magnitude and administration of this project. Planning for the Plum-Oasis Lateral Interceptor was conducted by IID staff. Once the size and location of the new interceptor channel and reservoir were completed, design began progressing concurrently with planning to determine the type of control structure to be used in the existing canals which would discharge into the Interceptor.

Managing the Program through the PCC concept has been working extremely well in providing planning and technical reviews and approvals in an expeditious manner with recommendations for studies required to resolve outstanding questions prior to initiating final plans and designs. Additionally, the requirement for the PCC to review and approve all project costs plus monitoring actual costs on a monthly basis provides a regular fiscal accountability to both MWD and IID.

While additional costs have been incurred due to the "fast track" nature of the Program, fortunately problems have been identified in time due to the close management of all Program elements by the PCC and IID staff. Through the substitution of alternative projects for those found not meeting the Program's cost versus volume of water conserved criteria, it is believed that the Program will meet its cost and conserved water objectives.

Appendix I - SI unit conversions

1 acre	=	0.40486 ha
1 mile	=	1.6093 km
1 acre-foot	=	1233.4 m ³

TEN KEY FACTS ABOUT
THIRD-PARTY IMPACTS AND WATER MARKETS IN CALIFORNIA

Carl Boronkay¹

Timothy Quinn²

ABSTRACT

This paper addresses the need for water marketing in California and provides information about the likely magnitude of the third-party impacts of water marketing. It also suggests several strategies that might be utilized to mitigate these impacts, while allowing market forces to play a greater role in water use decisions.

FORCES FOR CHANGE

For California's urban areas, water marketing is a policy imperative of the 1990s. The support of marketing concepts by urban water managers throughout the State signals a major shift in water policy. While most urban water managers recognize the need for further physical development of California's water supply system, there is an unmistakable trend toward support for better management of existing developed supplies and the reallocation of those supplies through voluntary market mechanisms as the primary method of meeting growing water demands during the 1990s.

Historically, California water law and policy was built upon the dual principles of constructing large water projects to increase available developed supplies and the legal doctrine of prior appropriation, which protected those developed supplies from incursions by others. This historic policy, developed largely with the interests of agriculture in mind, was by any reasonable economic measure hugely successful. It fostered a California agricultural economy that remains by far the largest

¹ General Manager, The Metropolitan Water District of Southern California

² Director, State Water Project and Conservation Division, The Metropolitan Water District of Southern California

in the nation. Similarly, the development of new water has been critical for the health of the California urban economy, which in 1990 produced more than \$700 billion in output and employed more than 14 million workers.

In recent decades, however, these policies of old have confronted two modern-day realities: phenomenal growth in the urban economy and the environmental movement. During the past quarter century, the California urban economy has grown at roughly twice the average growth rate of the national economy. Despite the current recession, most experts expect long-term growth to continue as California grows at least at the same pace as the rest of the nation. (Levy, S. and Robert K. Arnold, May, 1992) This economic growth has meant rising demands for water to meet the needs of urban residents and the urban economy.

Concurrent with growth in water demand, the environmental movement has all but shut down the traditional construction-oriented means of developing new supplies. Throughout California, rising urban water demands have been met with shrinking supplies. For Southern California, because of environmental litigation and regulatory proceedings, reliable supplies from the Los Angeles Aqueducts have been reduced by more than 30 percent. The State Water Project, originally designed to be the largest supply source for the region, can reliably provide only one-half the amount of water specified in the contract held by the Metropolitan Water District of Southern California. On the Colorado River, the decision of the United States Supreme Court in *Arizona v. California* [(1963) 373 US 546] reduced urban Southern California's firm water rights on that system from its contract rights of more than 1.2 million acre-feet of water to less than half that amount. The bottom line has been that since approval of construction of the State Water Project--which remains critically incomplete--California's population has nearly doubled, increasing from about 16 million to 30 million, while we have authorized no new projects during that period to increase the State's water supply.

THE ECONOMIC CASE FOR WATER MARKETING

The clash between rising urban demands for water and shrinking supplies has generated an intense interest

in water marketing--that is, the evolution of institutional arrangements through which the reallocation of existing supplies among competing uses can be accomplished through voluntary market sales of water, primarily (though not exclusively) from agricultural sellers to urban buyers.

The economic case for marketing is compelling. While once dominant in the California economy, agriculture today accounts directly for less than two percent of the State's economic production, while using more than 80 percent of developed water supplies. Based on a recent study by the Federal Reserve Board, even after considering the indirect employment attributable to agricultural production in the State, this sector accounts for only 3.3 percent of California employment. (Federal Reserve Bank San Francisco Weekly Letter) The California economy, like those of the other western states, has become highly urbanized, with an urban sector that provides the vast majority of its economic output and 97 percent of its jobs, while consuming less than 20 percent of developed water supplies.

This contrast between value of output and water inputs is even sharper when considering the likely economic realities of a water market. To the extent that market activity results in reduced agricultural production, the most likely sources of supply are low-value, high water-using field crops, such as cotton, alfalfa, irrigated pasture, rice, and other grains. These crops use more than 50 percent of the State's water supplies, but account for a mere 0.5 percent of the State's economic output. One thousand acre-feet of water applied to irrigate field crops supports about 1.5 jobs (compared to an average for all crops of about nine jobs per 1,000 acre-feet of water) and economic output valued at less than \$400,000. In the water-intensive sectors of the urban economy, the same amount of water supports 2,600 jobs on average (as many as 17,000 in certain high-tech industries) and economic production valued at nearly \$400 million. (Spectrum Economics, Inc., Oct. 1991).

Not only do field crops use vast amounts of water, many are, in fact, not economically viable in the market place without substantial government subsidies. More than 60 percent of the water used in California agriculture is applied to crops that benefit from federal price support programs. Many of these crops are in oversupply--so much so that during 1991 taxpayers paid farmers in California to fallow nearly

700,000 acres of land that would have further contributed to oversupply of low value field crops.

As California enters the twenty-first century, our water use priorities will inevitably change--the simple fact is that we will have to find ways to use less water for agriculture and more for our cities and environment. Water use patterns that evolved in an era of large publicly-financed water projects, low water prices, and environmental neglect cannot be sustained in an era of much more costly projects, much higher water prices, and a far greater degree of environmental sensitivity. For more than two decades, water agencies, agricultural and urban alike, have witnessed numerous attempts to take their water rights through regulatory proceedings in order to dedicate water for environmental purposes. Currently, in adversarial proceedings before the State Water Resources Control Board, the California Department of Fish and Game and other environmental organizations have recommended actions that, if implemented, could cost agricultural and urban water users millions of acre-feet in supplies. The development of market mechanisms will provide an opportunity for necessary reallocations of water through voluntary compensated approaches rather than through adversarial regulatory proceedings.

ADDRESSING THIRD-PARTY IMPACTS OF WATER MARKETING

Socioeconomic third-party impacts are one of the most emotional and divisive issues in the evolution of a water market in California. Third-party impacts are defined as those impacts on parties other than the buyer and seller of water in a market transaction. Examples of third parties that might be adversely affected by a water marketing transaction include farm workers who may be directly impacted as land is fallowed to transfer water or businessmen in the local agricultural economy who incur indirect impacts as local economic activity declines.

In agricultural areas, many fear that the elimination of the numerous existing constraints on the transfer of water would devastate the California agricultural economy. Accordingly, many in the agricultural community favor protectionist economic policies that would restrict competition for water resources and protect local economies from a loss of water to California's urban areas. Because these protectionist attitudes are so strongly-felt, it is imperative that

we develop objective information regarding the possible third-party impacts of water marketing and appropriate policy approaches to mitigate these impacts.

Third-party impacts are undeniably an important policy consideration. However, it is important to keep the issue in perspective. In fact, the third-party impacts of a California water market would be relatively small--much smaller than the ordinary fluctuations that occur in the California agricultural economy on a regular basis and well within a range that is manageable by sound public policies. Third-party impacts should not be used as a rationale to stifle much needed transfers of water within California to meet the needs of the State's \$730 billion economy and its environment. Rather, agricultural and urban interests should work together to develop sensible strategies that promote the movement of water resources to where they will do the most good for the overall State economy, while protecting third-party interests from unreasonable harm.

TEN FACTS ABOUT THIRD-PARTY IMPACTS

1) Many transfers have no adverse third-party impacts. In California, water transfers to date have emphasized approaches such as conjunctive-use-partnerships and urban-financed agricultural conservation programs to make water available in urban areas. Such transfers do not result in adverse socioeconomic third-party impacts. Urban areas will continue to develop these types of programs. However, these transfers, particularly those involving conjunctive use, are significantly constrained by capacity restrictions and environmental concerns in the Sacramento-San Joaquin Delta. Facility improvements in the Delta are necessary to maximize the potential for these water management programs.

2) Falling transfers will involve only a small fraction of agricultural water use. Although there is significant long-term potential for conjunctive use and conservation-based transfers, the economic and environmental needs of the state will require some transfers based on the short-term and long-term falling of land. However, the additional water needs of the California urban economy, including Southern California and the San Francisco Bay area, during the next quarter century will be less than

two million acre-feet annually--about seven percent of current agricultural water use in California. Given the uncertainties surrounding future facilities in the Delta, it is difficult to predict how much water might be made available from transfers involving conjunctive use and other nonfallowing programs and how much water might be made available for transfer through the fallowing of land. For purposes of illustration, many of the estimates of potential third-party impacts discussed in this paper are based on land fallowing in the Central Valley sufficient to transfer 500,000 acre-feet of water. This volume of fallowing activity would result in the transfer of less than two percent of current agricultural water use.

3) The amount of land fallowing required to transfer 500,000 acre-feet of water to urban areas would directly affect less than 0.5 percent of farm workers. In a relatively open market for water, most sales that involve land fallowing would involve lands on which field crops are grown. Field crops account for only eight percent of agricultural employment but use more than half of the agricultural water in the state. Because crops that are not labor-intensive would dominate such a water market, the direct employment impacts would be relatively small, affecting less than 0.5 percent of all farm workers in the state for transfers that could make available 500,000 acre-feet of water annually.

4) Even in agricultural areas like the Central Valley, agricultural labor accounts for a relatively small fraction of the regional payroll. Because of the size of the economies in cities in the agriculturally intensive Central Valley, such as Bakersfield, Fresno, Stockton, and Sacramento, agricultural labor is a relatively small part of the regional labor market. For instance, in the southern San Joaquin Valley, all agriculturally related labor accounts for only 11 percent of the regional payroll.

5) The potential third-party impacts of a water market would be small compared to normal market fluctuations in the agricultural economy. In recent decades, actual employment levels in the California agricultural economy have varied on average from year to year by about 14,000 workers--more than seven times the possible direct employment impacts that would result from a transfer of 500,000 acre-feet of water. Seasonal employment fluctuations are even greater, often exceeding 100,000 workers.

6) The impacts of a water market would be small compared to the impacts of federal programs designed to reduce agricultural output. As stated above, during 1991, California farmers voluntarily enrolled about 700,000 acres of land in federal "set-aside" programs under which payments are made to reduce production and support agricultural prices. These programs represent roughly four times the amount of land that would need to be fallowed to transfer 500,000 acre-feet of water to the urban economy or environmental uses.

7) The labor market impacts of a water market would be very small compared to the historical effects of increased mechanization in the farm economy. Since 1950, farm labor in field crops has declined by more than 60 percent while production has increased, largely because of increased mechanization on the farm. For example, the introduction of the tomato harvester reduced the process tomato workforce by 80 percent, from 44,000 workers in 1963 to about 8,000 in 1983. Similarly, the cotton harvester reduced labor requirements for that crop, once the largest employer of agricultural workers in California, by 50 percent. The employment impacts of the tomato harvester alone were more than 20 times greater than those that would result from the transfer of 500,000 acre-feet of water. Moreover, expected growth in Bakersfield, Fresno, Modesto, Stockton, and other Central Valley cities can readily absorb workers released from agricultural activities due to water marketing, increased mechanization, or other market events.

8) The health of the agricultural economy depends upon the well-being of the broader urban economy. The health of the agricultural economy is inextricably tied to the urban economy, which requires reliable water supplies from water transfers and other sources. For example, San Joaquin Valley agriculture exports about 80 percent of its products for sale outside the local area.

9) Farmers purchase about half of their nonlabor inputs outside their local area. About 50 percent of the materials and equipment purchased by San Joaquin Valley farmers are purchased from firms outside the local area. This implies that the consequences of decisions made in a water market would not only be relatively small but also would be spread out over a broad geographic area.

10) Compensation strategies can be designed to mitigate the third-party impacts that do occur in a water market. None of the above facts are intended to imply that third-party impacts are unimportant or should be ignored as a matter of policy. The facts do suggest, however, that these impacts are well within the range of ordinary economic consequences that arise from market forces in a free economy. Indeed, third-party issues appear manageable and should not be used as a rationalization against the evolution of market-oriented institutions to more efficiently use California's water resources.

Strategies to deal with third-party issues arising from the implementation of water marketing could include the following:

- a) Promote a variety of transfer approaches and improve facilities, especially in the Sacramento/San Joaquin Delta, to increase the potential for conjunctive-use and conservation-based transfers.
- b) Encourage geographically broad-based markets and include percentage caps in water transfer legislation that limit the extent of fallowing-based water marketing in specific local areas. All major transfer legislation now under consideration includes such provisions.
- c) Compensate worker impacts that clearly and directly result from specific transactions. Several models of compensation in other industries exist that could provide insight into appropriate compensation strategies.
- d) Assure that the existing safety net provided by the local, state, and federal governments is adequately maintained to deal with the indirect consequences of market activity.
- e) Provide adequate funding with financial assistance from areas receiving marketed water for retraining programs to facilitate the movement of workers into the growing Central Valley urban economy. Existing farm labor assistance programs include the Employment Development Department Job Referral and Matching Service and the Job Training Partnership Act 402 Program, which provides both basic education and job-specific training for displaced farm workers. Funding for these programs could be increased or complementary programs could be developed.

REFERENCES

1. Levy, S. and R. K. Arnold. 1992. *The Outlook for the California Economy--A Special Supplement to California Economic Growth*. Palo Alto: Center for Continuing Study of the California Economy, 1992.
2. *Federal Reserve Bank San Francisco Weekly Letter*, No. 92-20, (May 15, 1992).
3. Spectrum Economics, Inc., *Cost of Industrial Water Shortages*. San Francisco: Spectrum Economics, 1991.

A WATER MARKETING FRAMEWORK THAT MINIMIZES THE SOCIOECONOMIC IMPACTS OF LONG-TERM WATER TRANSFERS

Dennis Wichelns*

ABSTRACT

Much of the current discussion regarding long-term water transfers in the western United States involves the definition and measurement of third-party impacts, regional economic impacts, and potential losses in public welfare. Water agency officials, farmers, and members of resource advocacy groups are concerned that long-term water transfers will remove the economic livelihood from the region that is selling the water, causing economic hardship and dislocation of labor and capital. Academicians, water resource professionals, and state legislators have suggested that a portion of the revenues received from water sales could be used to compensate residents of these areas. However, the economic damages caused by long-term water marketing are difficult to measure and an appropriate compensation mechanism has not yet been developed.

This paper proposes an alternative approach to the issue of economic damages caused by long-term water transfers. The goal is to minimize the potential economic impacts to reduce or eliminate the compensation that may otherwise be required. The paper presents a program that places a limit on the volume of water that may be transferred away from a local area, while permitting all landowners and water users in the area of origin to share in the economic returns from long-term water transfers. The program can be modified to generate revenues for compensation, if these become desirable.

THIRD-PARTY AND SOCIOECONOMIC IMPACTS

Public interest in the long-term voluntary marketing of water from agricultural users to urban areas has increased during recent years, as a result of persistent drought conditions in California and the perception that urban water demands may exceed affordable water supplies for many years into the future. Water marketing is viewed by many water policy authorities as a relatively low-cost method of augmenting urban water supplies, while encouraging farm-level improvements in agricultural water management. Western state legislatures and the United States Congress have passed legislation that promotes water marketing and removes some of the obstacles that limited the scope of water markets in the past.

With this increased interest in water marketing, there has also been an increase in the discussion regarding third-party impacts of long-term water transfers from agriculture to urban areas (Chan 1989, Colby 1990,

*Assoc. Prof., Dep. of Resource Econ., Univ. of Rhode Island, Kingston, RI

Gould 1989, Nunn and Ingram 1988, Shupe, Weatherford, and Checchio 1989). These transfers may generate significant economic and cultural impacts on rural communities where agriculture is the largest component of the local economy (Charney and Woodard 1990, Howe, Lazo, and Weber 1990, Weber 1990). In an arid region, water is an essential input in agricultural production and in all other economically viable activities. Input substitution opportunities that normally arise when one input or one production activity is removed from such a region will not be available in the case of long-term water transfers.

Much of the recent discussion regarding water transfers in California and in other western states raises the issue of mitigating or compensating for third-party impacts. Typically, third-party impacts are defined broadly to include several types of impacts arising from long-term water transfers. Among these are impacts on third-party water rights holders and impacts on individuals and communities that derive primary or secondary economic benefits from the use of water in agriculture. A partial summary of the third-party and socioeconomic impacts that are most often discussed in the literature is presented in Table 1.

Third-party water rights holders include the farmers and other landowners who reside or farm within the same surface water system or withdraw groundwater from the same aquifer as farmers who are selling water in long-term water transfers. Third-party rights holders may receive a smaller water supply due to the reduction in irrigation return flows that may result when other farmers deliver less water to farm fields, resulting in less surface runoff and less subsurface drainage water. Similarly, farmers who use groundwater may experience an increase in pumping depths if large volumes of groundwater are exported from the basin in long-term water marketing agreements.

The hydrologic and economic impacts on third-party water rights holders can be predicted to some degree of accuracy using existing models that describe interactions among irrigation and drainage activities and local surface water and groundwater resources. These quantitative estimates could be used to design a fee structure that might be implemented as a tax on water transfers, to achieve a socially optimal level of transfer activity and to raise revenue for compensating the impacted parties.

Quantitative estimates of economic damages and a suitable compensation mechanism will be much more elusive in the case of socioeconomic impacts. These impacts include the loss in economic activity in the area from which the water is transferred, due to backward and forward linkages in the agricultural sector (Howe, Lazo, and Weber 1990). They also include the reductions in public goods that occur when water is removed from the region (Colby 1988). Public goods include the riparian wildlife habitat, vegetative areas, and aesthetic amenities that will be affected by the long-term removal of water from an arid area. Cultural or anthropological resources, such as a community's cultural heritage, may also be impacted by long-term water transfers (Parden 1989). In addition, the economic development benefits which provided the original

Table 1. Categories of Third-Party and Socioeconomic Impacts of Long-Term Water Transfers, as Described in the Literature

Third-Party Water Rights Holders

The farmers and other landowners who reside or operate within the same surface water system or withdraw water from the same groundwater aquifer as the farmers who are developing long-term water marketing agreements. The third-party rights holders may receive diminished irrigation water return flows or may experience an increase in pumping costs as a result of permanent water sales from the region.

Agricultural Factors of Production

The labor, capital, and other inputs used in agricultural enterprises in the region from which water is being sold. Agricultural laborers will have fewer employment opportunities and equipment dealers will have fewer sales, as a result of long-term water transfers.

Backward and Forward Economic Linkages

The industries and companies that provide inputs to agriculture or that utilize agricultural products. Manufacturers of farm equipment and processors of agricultural crops will face a reduced demand for their services in the area of origin.

Local Community Cultural Impacts

The economic livelihood and cultural identity of small towns and rural centers may be altered as a result of the direct economic impacts and the backward and forward economic linkages that are affected by long-term water transfers.

Public Welfare

The public-at-large receives benefits from water used in agricultural production, including the maintenance of agricultural land, open space, riparian wildlife habitat, and the social values that some members of the public attribute to agricultural communities. These values may be diminished as a result of long-term water transfers.

motivation for constructing many of the water projects in the American West will be diminished or lost when the water is removed (Dunning 1977).

Private individuals engaging in voluntary water transfers usually do not consider the impacts on third-party rights holders or the socioeconomic impacts described above. Therefore, the socially desirable level of transfers will be exceeded in an unregulated water market. Public policies will be required to ensure that third-party and socioeconomic impacts are addressed sufficiently in water marketing agreements. The greatest challenge in designing appropriate public policies is developing accurate and credible predictions of socioeconomic impacts, so that the correct levels of compensation can be determined. An optimal compensation mechanism must also be identified.

CHARACTERISTICS OF A DESIRABLE FRAMEWORK

Public concerns regarding the efficient use of water resources and the socioeconomic impacts of long-term water transfers give rise to a set of characteristics that define a desirable and feasible framework for conducting long-term water transfers. For example, a comprehensive public policy regarding water transfers should be consistent with applicable state and federal laws, it should support voluntary long-term transfers of water from agricultural users to urban areas, and it should seek to protect against third-party and socioeconomic impacts. The policy should also minimize the transactions costs imposed on agricultural sellers and urban buyers, unless some level of transactions costs would be useful in achieving the socially optimal level of water marketing activity (Colby 1990). Finally, the water marketing policy should provide for equitable treatment of farmers within and among irrigation districts.

The water marketing policy should place minimal restrictions on district-level and farm-level decisions regarding the use of land and water resources. The policy should transmit the correct economic incentives to district managers and farmers, while allowing these individuals to make subsequent decisions regarding resource use. Policies that address district-level management practices or farm-level cropping decisions directly will likely be less desirable than policies that allow managers and farmers to choose optimal combinations of activities, once the correct economic incentives have been provided.

In particular, an effective water marketing policy should be defined in terms of water volume, rather than in terms of irrigable area. A water volumetric framework addresses the relatively scarce resource directly, without working through the land component of agricultural production. This is critically important for three reasons: 1) the relatively scarce resource in most situations is water and not land, 2) urban buyers of agricultural water are usually interested in obtaining the water resource and are not interested in purchasing agricultural land, and 3) third-party and socioeconomic impacts of long-term water transfers are often a

function of irrigated area, rather than water deliveries. Hence, by defining water marketing policies in terms of water volume, the correct economic incentives regarding the use of scarce water resources can be transmitted and the third-party and socioeconomic impacts of water transfers can be minimized.

Water transfer agreements that specify an area of land to be left idle will likely generate greater third-party impacts than agreements that describe a specific volume of water to be transferred. Leaving land idle reduces the demand for non-water inputs in agricultural production, leading to reductions in regional economic activity. Farmers can often make water available for long-term transfers by improving the efficiency of water use, without retiring land from production. In fact, the demand for non-water inputs often increases as farmers substitute labor and capital for water, in crop production. This increased demand would actually stimulate regional economic activity.

WATER MARKETING WITH TRANSFERRABLE CERTIFICATES

This paper presents a program that should enable voluntary water marketing to move forward in California and other western states, while public water officials are developing better information to address socioeconomic impacts. The program includes the desirable features of a public policy regarding long-term water transfers, described above. Specifically, the program includes a restriction on the volume of water that may be transferred from individual water districts, to limit the reduction of economic activity in local areas. This restriction may become a binding constraint on water sales in districts where a larger volume of water would be marketed in the absence of such a restriction. However, the social benefits of maintaining economic activity in the region are expected to offset this loss in water market revenues.

In cases where the restriction on water sales is binding, some farmers who wish to sell a portion of their water allotment will not be permitted to do so. This situation could result in disruptive competition within individual districts for available marketing allotments. The program proposed in this paper includes a tradable certificates program, for use within individual districts, to permit all landowners in the district to benefit from the economic returns to water marketing, even if some landowners do not actually sell their water allotment. This component of the program will enhance the acceptability of water marketing restrictions and promote efficient water management among all farmers in participating districts.

Volumetric Definition of Water Market Allotments

A socially desirable and effective water marketing program in which third-party and socioeconomic impacts are minimized will require that water allotments and water marketing agreements are specified on a water volume basis. Allotments and agreements based on land do not generate the correct economic incentives regarding water use and they may

exacerbate potential socioeconomic impacts. The volumetric water market allotments could be specified in acre-feet or as a proportion of a district's water supply, but they should not be defined in terms of irrigated area. In some districts, this may require that the original water allotment is also re-defined in terms of water volume, rather than in terms of irrigated area.

The program described in this paper requires that public water officials, in consultation with appropriate specialists, determine the maximum volume of water that can be marketed voluntarily from individual water districts without imposing serious third-party or socioeconomic impacts. This task might be completed in the near-term by simply choosing a relatively small proportion of a district's water supply as the volume that could be marketed, while requiring that the remainder of the district's water supply remain in the district. This approach would ensure that a safe minimum amount of water would remain in the district, so that third-party and socioeconomic impacts would be minimal. Better estimates of actual third-party and socioeconomic impacts could be developed over time, as water transfers are implemented.

The volumetric water marketing allotments for individual districts should be determined conservatively when this program is first implemented. If the total volume of water made available for marketing is considered later to be too small, it will be relatively easier to increase the marketing allotments, than it would be to reduce them.

Individual Transferrable Certificates

The public water authority that determines the district-specific water marketing allotments will issue a corresponding number of individual transferrable certificates (ITCs) to each district in the state or region where the program is being implemented. One certificate will permit the owner of that certificate to market one unit of water, provided that the owner also has a unit of water to sell. Farmers can use their certificates to market water outside of the district or they may sell their certificates to other farmers in the district, without selling any of their water allotment. This permits all farmers to benefit financially from water sales, whether they sell their water or retain it for use in agriculture.

Each water district will distribute its ITCs among all landowners in the district, according to their water allotment. For example, a 10,000-acre district with a water supply allotment of 3.0 acre-feet per acre and a water marketing allotment of 0.5 acre-feet per acre would receive 5,000 ITCs. The district would distribute the ITCs among all landowners, giving 80 ITCs to a landowner with 160 acres in the district and giving 320 ITCs to a landowner with 640 acres in the district.

Distribution of the ITCs throughout the district will permit all landowners to participate in the economic returns made possible by voluntary water markets, even if they do not actually sell any of their own water allotment. Farmers wishing to sell more water than their own

ITC allotment will permit, will need to purchase additional ITCs from other farmers in the district. As a result, the ITCs will develop a market value of their own, based on the net returns to water in agricultural production and the price of water sold in long-term transfers. Essentially, the demand and supply conditions for water in long-term transfers will also determine the price and value of the ITCs.

The ITCs will be tradable within the district to which they are initially allocated, but they will not be tradable among water districts. This feature of the program ensures that the regional socioeconomic effects will be minimized, by limiting the volume of water that can be transferred from any one water district. Although districts vary in size and in proximity to population centers, they do provide an existing institutional structure for implementing the water marketing ITC program. Adjustments in the geographic boundaries in which ITCs are permitted to trade could always be made in the future, if such adjustments would improve the social efficiency of the program.

The market price for water will vary among districts, due largely to location-induced differences in water transportation costs. Farmers in districts located nearer to the urban areas purchasing the water will receive a higher price than farmers in districts located further away. This program works to the benefit of the more remote water districts because they will be approached by urban buyers when all of the ITCs in districts located closer to the urban areas have been committed. This will occur sooner with district-specific volumetric limits on long-term water sales, than it would in the absence of these restrictions. The transaction price of ITCs will also vary among water districts for the same reasons that the price of water will be different.

In summary, there are three levels of activity required for implementation of the water market ITC program (Table 2). A state-level or regional authority would determine the maximum volume of water that could be sold in each water district, and issue the corresponding number of ITCs to each district. Districts would distribute their ITCs among all landowners and then permit water marketing to occur. Farmers would voluntarily buy, sell, or hold ITCs in accordance with their own water marketing objectives.

An Example of the Water Market ITC Program

A hypothetical example displays the net gains to each participant that result from the trading of individual tradable certificates (Table 3). Consider, again, one of the farmers in the irrigation district with a 3.0 acre-feet per acre water supply allotment and a 0.5 acre-foot per acre water marketing allotment. A farmer owning 160 acres of land in this district would receive 80 ITCs. Suppose this farmer wishes to sell 1.0 acre-feet per acre of his/her water supply allotment in a long-term water market transaction. The farmer would first need to obtain an additional 80 ITCs in order to sell a total of 160 acre-feet of water.

Table 2. Activities Required by State-Level and District-Level Authorities to Implement a Water Market ITC Program

State-Level or Regional Authority

Determine the maximum volume of water that may be sold in each water district.

Issue the corresponding number of individual transferrable certificates (ITCs) to the manager of each water district.

One ITC would permit the long-term sale of one unit of water.

Irrigation District

Distribute the district's ITCs to all landowners in the district, in proportion with each landowner's water allotment.

Allow landowners to buy and sell ITCs within the district.

Allow voluntary long-term transfers to occur, until all of the ITCs in the district are committed to water sales agreements.

Farm Level

Farmers wishing to sell a portion of their water supply allotment would need to obtain a corresponding number of ITCs.

Farmers wishing to sell less water than their allotment of ITCs would permit would be able to sell remaining ITCs to other farmers.

Table 3. Example of a Water Market ITC Program

District-Level: Suppose that a water district with a water supply equivalent to 3.0 acre-feet per acre is given ITCs equivalent to 0.5 acre-feet per acre. Each landowner would receive 0.5 ITCs for each acre of land.

Farm-Level: A farmer owning 160 acres of land would receive 80 ITCs in this program. Suppose the farmer wishes to sell 1.0 acre-feet per acre, rather than 0.5 acre-feet per acre. This would require the farmer to obtain an additional 80 ITCs from other farmers in the district.

Transaction Prices: Suppose the average annual net returns to water used in farming are \$60 per acre-foot and the annual equivalent of the urban offer price for water is \$150 per acre-foot at the district turnout. Suppose the long-term discount rate used to determine the capitalized value of water and ITCs is 7.5%. This generates a long-term agricultural value of water of \$800 per acre-foot and an urban offer price for water, in a long-term sale, of \$2,000 per acre-foot. Transaction prices for ITCs will range from \$0 to \$1,200 per ITC.

Results: Suppose the farmer selling water is able to obtain the 80 additional ITCs at a price of \$600 per ITC, or a total of \$48,000. The 160 acre-feet that are sold generate revenue of \$320,000. The net revenue to the farmer is \$272,000, or \$1,700 per acre. Farmers who have sold ITCs in this example have earned a total of \$48,000, or \$300 per acre, while retaining all of their water allotment.

The price of an ITC in the district will be determined by demand and supply conditions in both the crop production and water markets. For example, if the average net returns to water in the district are \$60 per acre-foot and the annual equivalent of the urban offer price for water is \$150 per acre-foot at the district turnout, a farmer selling an acre-foot of water can realize an increase in net returns of \$90 per acre-foot. Capitalizing the annual value of \$90 per acre-foot at a 7.5% long-term discount rate provides a maximum willingness to pay for an ITC of \$1,200 per ITC. The farmer buying ITCs would prefer to pay something less than \$1,200 for an ITC, while the farmer selling the ITCs would prefer to receive the full \$1,200. Hence, the actual transaction price will be within the range of \$0 to \$1,200 per ITC.

Suppose the farmer selling water is able to obtain the 80 additional ITCs at a price of \$600 per ITC, or a total expenditure of \$48,000 for ITCs. The farmer then sells the 160 acre-feet of water at \$2,000 per acre-foot (\$150 per acre-foot annually, capitalized at a 7.5% long-term discount rate), generating total revenue of \$320,000. The net revenue, after subtracting the cost of 80 additional ITCs is \$272,000, or \$1,700 per acre. Farmers selling ITCs in this example will earn a total of \$48,000, or \$300 per acre, while retaining all of their original water supply allotment.

Farmers selling their ITCs will be able to maintain full crop production activities, because they have not sold any of their water. In addition, they receive a cash payment for their ITCs from farmers wishing to sell water in long-term marketing agreements. In the future, if the farmers who had previously sold their ITCs decide to sell some of their water supply allotment, they will need to obtain ITCs from other farmers in the district. These could be purchased from farmers who have not previously sold any water outside the district and who have not sold their ITCs to other farmers. If all of the ITCs in the district have been committed to long-term water sales, farmers wishing to develop new water marketing agreements would need to buy-out an existing water marketing contract, in order to obtain the ITCs that were committed to that agreement. This feature of the ITC program permits farmers to change their intentions regarding long-term water transfers, while providing protection against third-party and socioeconomic impacts.

Farmers who choose to sell a portion of their original water allotment in a long-term water marketing agreement would still be permitted to conduct agricultural operations with their remaining water allotment. In some cases, farmers will be able to maintain the same average area planted and the same average production levels as they achieved prior to selling a portion of their water allotment. When this occurs, the regional economic effects of the water transfer agreement should be negligible and may even be positive if the farmer substitutes irrigation labor or capital for the water that has been marketed. Farmers might even choose to plant higher valued crops which require greater labor or capital inputs, as they respond appropriately to the higher opportunity cost for water that has been made evident by the long-term marketing opportunities.

SUMMARY AND CONCLUSIONS

The water marketing framework proposed in this paper is designed to minimize the potential third-party and socioeconomic impacts of long-term water transfers from agricultural to urban areas. The program includes volumetric definition of both the original water supply allotment and the water marketing allotment that is determined for each irrigation district in the state or region that is implementing the program. A state or regional water marketing authority would determine each district's water marketing allotment and then issue the corresponding number of individual transferrable certificates to each irrigation district. Farmers in the district would be allowed to buy and sell ITCs in order to conduct the level of water marketing that is consistent with their long-term goals.

Program parameters in this framework can be modified, over time, as additional information becomes available regarding the demand and supply of water in long-term marketing agreements and the third-party and socioeconomic impacts that actually arise when these agreements remove water from local areas of origin. In the near future, significant social benefits can be earned by permitting some water to be sold by agricultural users to urban areas. This framework should permit these long-term sales to occur, while protecting against large third-party and socioeconomic impacts. The framework also permits all farmers in participating water districts to benefit economically as a result of the long-term sales, even if they choose to retain all of their original water allotment. These characteristics of the water market ITC framework should enhance its acceptability among farmers and water industry professionals.

REFERENCES

- Chan, Arthur H., 1989. To market or not to market: Allocating water rights in New Mexico. Natural Resources Journal, 29(3):629-643.
- Charney, Alberta H. and Gary C. Woodard, 1990. Socioeconomic impacts of water farming on rural areas of origin in Arizona. American Journal of Agricultural Economics, 72(5):1193-1199.
- Colby, Bonnie G., 1990. Transactions costs and efficiency in western water allocation. American Journal of Agricultural Economics, 72(5):1184-1192.
- Colby, Bonnie G., 1988. Economic impacts of water law - State law and water market development in the Southwest. Natural Resources Journal, 28(4):721-749.
- Dunning, Harrison C., 1977. Reflections on the transfer of water rights. Journal of Contemporary Law, 4:110-117.
- Gould, George A., 1989. Transfer of water rights. Natural Resources Journal, 29(2):457-477.

- Howe, Charles W., Jeffrey K. Lazo, and Kenneth R. Weber, 1990. The economic impacts of agriculture-to-urban water transfers on the area of origin: A case study of the Arkansas River Valley in Colorado. American Journal of Agricultural Economics, 72(5):1200-1204.
- Nunn, Susan C. and Helen M. Ingram, 1988. Information, the decision forum, and third-party effects in water transfers. Water Resources Research, 24(4):473-480.
- Parden, Shannon A., 1989. The Milagro Beanfield War revisited in Ensenada Land and Water Association v. Sleeper: Public welfare defies transfer of water rights. Natural Resources Journal, 29(3):861-876.
- Shupe, Steven J., Gary D. Weatherford, and Elizabeth Checchio, 1989. Western water rights: The era of reallocation. Natural Resources Journal, 29(2):413-434.
- Weber, Kenneth R., 1990. Effects of water transfers on rural areas: A response to Shupe, Weatherford, and Checchio. Natural Resources Journal, 30(1):13-15.

ARTIFICIAL RECHARGE OF GROUNDWATER

Herman Bouwer*

ABSTRACT

Since planning for droughts must be done in wet cycles, storing surplus surface water behind dams or in aquifers is essential. Underground storage is enhanced by increasing the infiltration of water into the soil, using in-channel and off-channel spreading systems and basins. In-channel spreading is achieved with low dams or weirs that increase the width and depth of streams, or by constructing T- or L-dikes in the streambed to spread the water over the entire width of the bed. Off-channel systems are mostly specially constructed infiltration basins or old gravel pits. Contrary to what may intuitively be expected, shallow basins tend to give higher infiltration rates than deep basins because there is less compaction of clogging layers that accumulate on the bottom due to suspended solids and biological activity. This is demonstrated with a soils engineering analysis and with field data. Artificial recharge can also be important in temporary storage of water, for example, in connection with seasonal changes in the use of sewage effluent for irrigation or in the demand for drinking water. For the latter, such aquifer storage and recovery generally is much less expensive than building water treatment plants with enough peaking capacity or surface storage. Artificial recharge also can play a role in the reuse of wastewater because it provides treatment benefits, gives seasonal storage, and improves the aesthetics of water reuse by breaking up the pipe-to-pipe connection of direct reuse.

*Chief Engineer, U.S. Water Conservation Lab, ARS-USDA 4331 E. Broadway, Phoenix AZ 85040

Introduction

Storage of water in times of water surplus is becoming increasingly important to meet water demands in times of water shortage. Water shortages occur where demands exceed supplies, where over-pumping of groundwater diminishes groundwater resources, and where there are extended dry periods. The possibility of reduced rainfall due to global climatic changes and greenhouse effects is prompting water agencies to look at different scenarios so that they will be prepared for the future. Natural recharge of groundwater is particularly vulnerable to changes in rainfall, especially in zones with low rainfall where a small reduction in precipitation can cause a large reduction in groundwater recharge.

All these factors focus attention on increased storage, surface as well as underground storage. The latter is achieved through enhanced recharge of groundwater (for example, by vegetation management to reduce evapotranspiration) and by artificial recharge with surface infiltration systems or through injection wells. Sources of water for artificial recharge include any surplus surface water and water of impaired quality such as sewage effluent, storm runoff, or irrigation return flow.

Infiltration Systems

Infiltration systems require permeable soils, vadose zones without severely restricting layers that could cause excessive perched mounding, and unconfined aquifers with sufficient transmissivity for lateral flow through the aquifer without excessive mounding (Figure 1). Also, soils, vadose zones, and aquifers should not be contaminated with undesirable chemicals, and there should be no other water quality problems. Conventional infiltration systems can be grouped into in-channel and off-channel systems (Figure 2).

In-channel systems are weirs, dams or levees that spread the water over a streambed or flood plain, usually designed to be replaced or repaired after spring runoff or other flooding. Dams may be built with washout sections, while the smaller weirs and levees are considered expendable and easy to reconstruct completely. Off-channel systems may consist of old gravel pits or of specially built basins. These are most common in California, where there are hundreds of successful projects. Infiltration rates during inundation often range from 1 to 10 ft/day. Year-round recharge systems with periodic drying and cleaning of the basins are typically rated at 100-1,000 ft/year. Periodic drying and cleaning are vital because soil clogging lowers infiltration rates. Silt, clay and other fines can accumulate to form clogging layers from less than 0.1 in. to more than 2 ft thick. Even with clear water, biofilms can develop on the wetted perimeter, and algae can clog the bottom soil.

logging tends to be more severe when the water is stagnant as in basins than when it is moving as in recharge channels or T-levee systems. When infiltration rates drop too low, drying the system shrinks and partially decomposes algae, biofilms and other organic deposits. This may be sufficient to restore infiltration rates. Clogging material such as silt or clay deposits must be physically removed from the bottom by "shaving" with a front-end loader, scraping or other means. Plowing or disking the clogging layers into the soil will improve the bottom temporarily, but the fines will then accumulate deeper in the soil so that eventually the entire top layer must be removed. Optimum lengths of flooding and drying periods depend on the soil, the suspended-solids content and nutrient levels of the water, and the climate. Some recharge systems in arid regions operate only during rain or flooding. Other cycles are controlled by environmental factors (insect breeding, odors, slightly floating algae) or recreational demands. Thus, cycles may vary from four days flooding and 10 days drying to 11 months flooding and one month drying.

The water depth in infiltration basins should be carefully selected. The hydraulic heads of large water depths produce high infiltration rates, but they also tend to compress clogging layers, raising the hydraulic resistance of the bottom. Thus, contrary to intuitive expectations, deep basins can produce lower infiltration rates than shallow basins (Bouwer and Rice, 1989). Also, the rate of turnover of the water in a deep basin may be less than in a shallow basin, allowing more suspended algae to grow in longer exposure to sunlight. This aggravates the clogging by formation of an algal filter cake on the bottom, and by precipitation of calcium carbonate due to increases in the pH of the water resulting from uptake of dissolved carbon dioxide by photosynthesizing algae.

The second design criterion is that the ground-water table must be deep enough below the infiltration system so that it does not interfere with the infiltration process. This applies to the permanent water table and the mounding caused by recharging, as well as to perched ground-water mounds that may form on restricting layers in the vadose zone. Where infiltration rates are controlled by the clogging layer (which is the rule rather than the exception for basins and ponds), the water table must be 3 ft or more below the bottom of the basin. Where there is no clogging layer, the vertical distance of the groundwater table below the water surface of the infiltration system at some distance from the ponds should be at least twice the width of the infiltration system if infiltration rates are not to be encumbered by groundwater levels. Thus where groundwater levels are high, maximum

infiltration rates can then only be obtained with long narrow streams or basins spaced well apart. Equations have been developed to calculate the rise of groundwater mounds below infiltration systems (Bouwer, 1978, and references therein).

Infiltration systems must be tailored to local geohydrology, water quality and climate. In general, basins should be less than 2 ft deep and hydraulically independent so that each can be flooded, dried and cleaned according to its best schedule. Inlet structures must not cause soil erosion that could clog basin bottoms. Drying periods should be started before infiltration rates have reached low values. Drying is then accomplished by infiltration, and pumping or draining the basins is not necessary. Finally, there should be a number of basins for flexible operation, with some in reserve to handle maximum water flows.

Water Quality

For relative pure water, the most important quality parameters for groundwater recharge are suspended solids (SS), total dissolved solids (TDS) and major cations such as calcium, magnesium and sodium. Periodic cleaning is necessary when SS causes clogging of the wetted perimeter of infiltration systems. Where the SS content is too high, the water is first passed through desilting or presedimentation basins to reduce cleaning costs. Coagulants may be added for this process, and on-site experiments will determine the best combination of pretreatment and cleaning schedules for hydraulic capacity and economy of operation. TDS and concentrations of calcium, magnesium and sodium determine whether a clay is dispersed or flocculated and therefore whether it has a relatively low or high hydraulic conductivity. This affects clay in the clogging layer and further down. Thus, TDS, calcium and magnesium should be high enough and sodium low enough to keep clay in the clogging layer and below in a flocculated, relatively permeable state.

In infiltration systems, recharging sewage effluent, storm runoff or other polluted water can improve its quality. Suspended solids are removed, biodegradable organic matter is decomposed, microorganisms are taken out, concentrations of nitrate and synthetic organic compounds are reduced, and phosphate and heavy metals are immobilized. Because of this, groundwater recharge can be used as a step in the treatment train for reuse of wastewater. It is then called soil-aquifer treatment (SAT) or geopurification (Bouwer, 1991).

To protect high-quality native groundwater and nearby drinking water wells, SAT systems are designed as recharge-recovery systems where recharge water is pumped out of the aquifer again with strategically located interceptors. The

water typically can be used as such for irrigation and recreation and, with further treatment, for drinking. SAT systems are inexpensive and simple to operate, and enhance the aesthetics of using recycled sewage for public water supplies by breaking the toilet-to-kitchen faucet connection. Special regulations are being developed in California for blending of recharge water with native groundwater to allow potable use of the water after SAT without further treatment (Hultquist et al., 1991).

Well Injection Systems

Groundwater recharge with infiltration systems is not feasible where permeable surface soils are not available, vadose zones have restricting layers or are otherwise unsuitable, or aquifers have poor quality water at the top or are confined. For those conditions, groundwater recharge can be achieved with injection wells. To prevent clogging of the aquifer interface around the recharge well, the water should first be treated to remove all suspended solids. To minimize growths of biofilms, BOD, nutrients, and microorganisms should also be removed. Even then, a residual chlorine content still is necessary to control bio-clogging of the well and aquifer. Thus, water for well injection should be treated to essentially drinking water standards before it goes into the well. In addition, the wells should be frequently pumped (about 10 minutes per day, for example) and periodically redeveloped, depending on decreases in specific capacity for recharge. This makes groundwater recharge through wells much more expensive than recharge with infiltration basins. Where reclaimed sewage effluent is used for well injection, treatment benefits in the aquifer tend to be relatively small because aquifers usually are coarse textured. However, SAT systems with well injection still offer the benefits of aesthetics and improved public acceptance of water reuse (no pipe-to-pipe connection), and some quality improvement ("aging" and "polishing" effects).

Aquifer Storage and Recovery (ASR) Wells

A new and rapidly spreading practice in artificial recharge is the ASR well. These wells are combination recharge and pumping wells. They are used for recharge when surplus water is available, and pumped when the water is needed. ASR wells typically are used for seasonal storage of drinking water in areas where water demands are much greater in summer than in winter. Drinking water treatment plants then are designed for mean annual capacity. The winter surplus is stored underground with ASR wells, which are pumped in the summer to augment the production from the water treatment plant. The only treatment for the water from the wells then is chlorination. The combination of mean flow capacity treatment plants and ASR wells is cheaper than peak flow capacity treatment plants and no wells.

Artificial Recharge Issues

Currently, there are three main issues in artificial recharge of groundwater: health effects, system sustainability, and artificial recharge under difficult soil and hydrogeological conditions. Concern about health effects occurs primarily in recharge systems where the source water is of low quality; i.e., sewage effluent, storm runoff, or agricultural runoff or return flow. The main concerns are about toxic organic compounds ("bad TOC!") that have survived the SAT process, and about disinfection byproducts (DBPs) if the water after SAT is chlorinated (other disinfection processes may also produce DBPs). DBPs can also be present in the water before SAT, if sewage effluent is chlorinated before discharge and the DBPs are not removed by SAT. For these reasons, it may be best to only mildly chlorinate or otherwise disinfect the effluent prior to infiltration, and then use UV after SAT when the turbidity of the water is very low for final disinfection. Humic and fulvic acids may be formed in the soil during SAT. These compounds are known THM-precursors. Thus, the water after SAT preferably should not be chlorinated but disinfected with other techniques such as UV.

In general, adverse health affects from drinking water after SAT or low quality input water can best be minimized by designing SAT systems with complete, systematic recovery of the recharge water from the aquifer. This then allows post-treatment of water after SAT with the appropriate technology (activated carbon filtration, reverse osmosis, UV irradiation) to minimize bad TOC and DBPs in the water. Where the recovery of water after SAT is with randomly distributed wells in the aquifer system, post treatment is difficult and dilution with unpolluted native groundwater is relied upon to get bad TOC and other toxic materials to low concentrations. For example, new California regulations would allow only 20 to 50% sewage derived water in the well water, depending on the treatment of the sewage prior to infiltration (Hultquist et al., 1991).

Health effects are extremely difficult to assess. Epidemiological studies of the population drinking the water are extremely expensive and often inconclusive. Toxicological studies, including rodent bioassays on concentrates of the water after SAT, also may not be meaningful. Other health concerns are primarily microbiological and have to do with pathogens that may be ingested by eating raw vegetables irrigated with sewage water after SAT, inhaling aerosols, and accidental ingestion where water after SAT is used for swimming. There is also concern about contact with the water as with parks and playgrounds irrigated with the water, or farmers using the water for irrigation.

Sustainability of SAT systems has to do with the possible accumulation of certain minerals and organic compounds in the soil and aquifer and how this

ffects the underground environment. Most SAT processes are renewable and stainable (removal of BOD, NO_3 , turbidity, and microorganisms). However, some chemicals may go through SAT (refractory organics), and some may accumulate in the soil and aquifer (adsorbed organics, metals, phosphate). Little is known about accumulating effects, although SAT systems generally are considered as having very long useful lives (decades, centuries). More knowledge on the sustainability of SAT and the proper closing and decommissioning of SAT projects is needed.

Because artificial recharge and SAT offer distinct advantages over other options (surface storage, in-plant treatment), interest is growing in doing artificial recharge and SAT under unfavorable conditions, such as less permeable soils, shallow bedrock, or restricting layers in the vadose zone. Under such conditions, protocols for step-by-step site investigation procedures must be set up to evaluate the conditions and to make sure that there are no "fatal flaws" that make recharge and SAT essentially impossible. The costs of these investigations may be high, but the costs of an undetected fatal flaw may be much higher. SAT will be more expensive per acre foot of water for less favorable than for favorable conditions, but it may still be cheaper and more advantageous than other options.

Conclusions

Artificial recharge with infiltration systems is an effective way for storing water underground and for improving the quality of the water, especially if it is sewage effluent or other water of low quality. Where surface infiltration is not feasible or possible, aquifers can be recharged through injection wells. This process, however, requires pretreatment of the water to essentially drinking water standards, and is much more expensive (often an order of magnitude more) than recharge with surface infiltration systems. Artificial recharge is an important tool in water resources management, storing surplus water during times of adequate supplies for use in times of water scarcity. Artificial recharge with full recovery of the water from the aquifer also will be an important tool for water reuse because it provides low cost treatment and storage of the water, and it enhances the aesthetics and public acceptance of water reuse by breaking up the pipe-to-pipe connection of direct reuse of wastewater.

REFERENCES

1. Bouwer, Herman, 1978. Groundwater hydrology, *McGraw-Hill, New York NY*, 480 pp.
2. Bouwer, Herman, 1991. Groundwater recharge with sewage effluent. *Water Sci. and Techn.* 23:2099-2108.
3. Bouwer, Herman and R. C. Rice, 1989. Effect of water depth in groundwater recharge basins on infiltration. *J. Irrig. and Drain. Eng.* 115:556-567.
4. Hultquist, R.H., R. H. Sakaji, and T. Asano, 1991. Proposed California regulations for groundwater recharge with reclaimed municipal wastewater. Proc. 1991 Specialty Conference on Environmental Engineering, Am. Soc. Civ. Engrs, Reno, Nevada, 759-764.

LONG-TERM STORAGE THROUGH INDIRECT RECHARGE

Larry R. Dozier¹

Clifford A. Neal²

ABSTRACT

The Central Arizona Project is nearing completion and is currently operating in partial capability. Central Arizona finds itself with a plentiful water supply available from the Colorado River but without the physical or economic resources to fully use the supply. The state of agricultural economics is such that irrigation is not profitable using the high cost CAP supply. Yet as we look toward the future, central Arizona can expect shortages of Colorado River supplies 25 to 50 years in the future and short term loss of supply from system outages due to maintenance or unplanned failures.

The Central Arizona Water Conservation District, working with the Arizona Department of Water Resources and local irrigation districts, is developing indirect recharge programs to promote present day use of available Colorado River supplies instead of groundwater pumping. At the same time, the programs provide long-term storage for protection against temporary system outages and shortages in long-term supply. While 1992 will be the first year for such programs by CAWCD or anyone in Arizona, we hope it will demonstrate a win-win program for all.

BACKGROUND

As the Central Arizona Project (CAP) is nearing completion of construction, the Central Arizona Water Conservation District (CAWCD)³ is planning ahead to enhance operational capability. In 1992, the CAP was capable of making deliveries through approximately 90% of the 330 mile long system. With the full pump diversion capability of 3000 ft³/sec and a "normal" water supply available from the Colorado River, the CAP has the

¹Assistant General Manager, Central Arizona Water Conservation District, Phoenix, Arizona

²Engineer/Hydrologist, Central Arizona Water Conservation District, Phoenix, Arizona

³CAWCD is the agency created by the Arizona state legislature to operate the CAP and repay the United States for reimbursable construction costs associated with the project.

opportunity to use 1.5 million acre-feet (MAF) per year. However, in 1992, actual use is expected to be only about one-half of that amount. Water available to CAP, but not used, most likely will not remain in storage in the Colorado River system but will be used by California.

Many CAP allottees will not be taking their full allocation for several years. The CAP was planned to meet the future growth needs of municipal and industrial (M&I) and Indian users. In the interim, it was to replace current groundwater use for agriculture and, to some degree, for M&I purposes. Growth in the M&I sector has slowed. With the current depressed agricultural economic conditions in central Arizona, the irrigated acreage is probably less than one-half of the potential maximum. In many instances, the cost to pump groundwater is less than one-half the cost of CAP water; consequently, groundwater is often used instead of CAP water. The result is, although we have the capability to deliver all of the Colorado River water available to CAP, there will be a significant amount of water available to Arizona that will not be used or stored for future use unless something is done. These current conditions of supplies exceeding demand will not last. In fact, municipalities in the Phoenix and Tucson areas are currently seeking to acquire additional water supplies for use in the future as populations continue to increase. One logical source of water to satisfy future needs is today's excess water.

A primary objective of the CAP was to replace the current use of pumped groundwater by agriculture with the use of renewable surface water supplies from the Colorado River. The conserved groundwater supply would then be available for use during critical periods in the future when Colorado River supplies are short due to drought. Yet it is the availability and use of that groundwater which plays a major role in today's demands for CAP water by the agricultural entities served by the CAP. A number of the irrigation districts (IDs) have an allocation of federal hydropower which can be used to pump groundwater at a relatively low price. In order to maintain the allocations to federal hydropower, the IDs must use it to provide water to lands within their service areas, otherwise they face the threat of losing the allocation due to non-use. The agricultural entities need to maintain their hydropower allocations for two reasons: (1) CAP cannot deliver all of the water that the agricultural subcontractors use during peak months due to CAP aqueduct capacity constraints, and (2) the CAP supply available to agriculture declines as M&I uses grow. Because groundwater is less costly than CAP water, and because the IDs want to exercise the right to all of their hydropower allocation, groundwater is used as the basic water supply and CAP water serves as a secondary source. Therefore, a significant amount of the agricultural water demand is still being served by groundwater despite the availability of CAP water.

CAWCD has continually sought ways to maximize the use of the CAP system, to effectively use Arizona's share of the Colorado River supplies, and to reduce Arizona water users' reliance on groundwater. As such, we have been involved in plans to directly recharge the excess CAP water supplies. Yet, increasing direct use in lieu of groundwater pumping appeared to be a less costly and more readily available alternative. Therefore, in 1991, we began to earnestly pursue opportunities for indirect recharge.

RECHARGE CONCEPTS AND OPPORTUNITIES

Arizona has a strong framework for management of groundwater resources. The 1980 Groundwater Management Act (GMA) provides the basis for management and accounting of the use of groundwater. A subsequent amendment to the GMA provided for the underground storage and recovery of water supplies through direct recharge projects. A later amendment made provisions for underground storage through reduction in groundwater pumping.

Indirect recharge operates on the basis of surplus CAP water being used in place of groundwater. Upon demonstrating that a substitution has taken place, in-lieu recharge credits, which enable the holder of such credits to remove groundwater for subsequent use, are created. The opportunity to purchase excess CAP water and to create, hold, and use in-lieu credits is available to CAWCD and other individual entities.

The CAP is currently delivering water to 10 IDs, nine of which are located within the boundaries of the state's three groundwater Active Management Areas (AMAs). All of these IDs are pumping some groundwater and offer an opportunity for development of indirect recharge projects. Initial efforts focused on the two largest IDs (about 85,000 acres each) within CAWCD's service area, the Maricopa-Stanfield Irrigation and Drainage District (MSIDD) and Central Arizona Irrigation and Drainage District (CAIDD). Success of developing these two projects cleared the way for subsequent projects involving the seven remaining IDs located within the AMA boundaries, Roosevelt Water Conservation District (RWCD), Tonopah Irrigation District (TID), Queen Creek Irrigation District (QCID), San Tan Irrigation District (STID), Chandler Heights Citrus Irrigation District (CHCID), Hohokam Irrigation and Drainage District (HIDD), and New Magra Irrigation and Drainage District (NMIDD).

Background

IDs served by CAWCD fall generally in two categories: (1) Those which control all water deliveries to the individual farmers (including groundwater), and (2) those which deliver only CAP water to farmers upon specific request by the farmer. CAIDD, MSIDD, RWCD, STID, and CHCID fall into the first category, while TID, QCID, HIDD, and NMIDD fall into the second category. Those IDs in category one above are steadily improving their capability to operate as conjunctive use districts, where both surface water and groundwater sources are commingled to optimize operations. Water is delivered to the individual farms through a district owned distribution system. The irrigation district controls the water wells within its boundaries and pumps groundwater for delivery directly to an adjacent farm or into the distribution system for use elsewhere in the district. Water orders from the individual farmers are satisfied from any source available to the district and the farmers pay for it on a "postage stamp" price schedule that is independent of the source.

Those IDs in the second category above do not maintain control of the wells within the district. The individual farmers own and operate the wells and, therefore, decide whether to pump groundwater or use CAP water. If the farmer chooses to use CAP water, an order is given to the ID, and the ID delivers the CAP water through a district-owned distribution center.

Several IDs are operationally integrated with one or more Electrical Districts (EDs). For example, MSIDD is the primary customer of Electrical District No. 3 and CAIDD is the primary customer of Electrical Districts Nos. 4 and 5. Some of the EDs have contracts with the United States for hydropower generated by the Hoover, CRSP, and Parker-Davis projects. Groundwater pumped with federal hydropower is the least expensive source of water available to these IDs.

The IDs are also contractors for CAP water under both interim and long term subcontracts. Some IDs also have other sources of surface water. The IDs can also purchase steam generated electrical power from Arizona Public Service or Salt River Project either through the Arizona Power Authority (APA) or directly. Groundwater pumped with such power may be more expensive than CAP water. Steam power is sold to the EDs and subsequently to the IDs at rates which include a monthly capacity charge based on the irrigation districts' peak use.

Generally, any water needs which exceed available surface water supplies and hydropower-pumped groundwater supplies are met with CAP water or groundwater pumped with steam power. IDs with relatively shallow

groundwater levels find groundwater pumped with steam power less expensive than CAP water, while other IDs with greater pumping depths use steam power only as a last resort when CAP outages or capacity constraints limit the availability of CAP water. Since steam power is sold with both energy and capacity rate components, the IDs will try to schedule the CAP water during peak water demand periods to reduce the payment for capacity to the most expensive pumping power supplier.

Operations During the Recharge Period

Under current policy, surplus CAP water is available for recharge at a reduced price. The ID participating in the recharge project (the "recipient") must agree to reduce groundwater pumping on a gallon for gallon basis in exchange for the indirect recharge water provided to it. The entity who purchases the indirect recharge water (the "permittee") accrues the recharge credits.

Indirect recharge requires that there is both adequate capacity in the CAP canal and adequate demand by the recipient. As a practical matter, these conditions will most often occur simultaneously in the shoulder months on either side of the peak summer demand months. Day-to-day CAP operations will be minimally affected, as recharge water will only be delivered on a space-available basis after all orders for CAP water for direct use have been met.

In an effort to make indirect recharge a viable operating option for IDs with federal hydropower allocations, a method was developed to ensure that the hydropower allocations would be maintained even if the associated power was not used to pump groundwater within the affected ID's service area. In such a case, the participating ID agrees to take delivery of indirect recharge water and forego pumping an equivalent amount of groundwater with its hydropower. The "unused" hydropower is paid for by the participating ID and scheduled to CAWCD for use in delivering all or a portion of the ID's regular CAP water order. The ID is required to pay CAWCD only the non-energy component of the current CAP price for CAP water delivered with the ID's hydropower. Under this plan, the participating ID does not risk losing its hydropower allocation because the power is still being used to deliver water to lands within its service area.

Where CAWCD participates in indirect recharge projects within the Phoenix or Tucson AMAs, recovery is not expected to be a serious concern. Cooperating entities will take future CAP deliveries from our recharge credits using their service area wells as long as we pay the pumping cost. In this case, the CAP customer will continue to pay the

current postage stamp rate for any CAP water recovered and delivered as part of their CAP allocation.

Outside the urban AMAs, a recovery method must be identified and provisions for recovery made in the recharge agreement. CAWCD proposes to recover its underground storage credit by exchange. Essentially, the IDs will submit their water schedules in the usual manner. CAWCD would exercise options obtained via agreement to require them, to the extent that pump capacity is available, to use the CAP underground storage credits to meet some or all of their CAP water orders as well as the orders of Indians and the small M&I entities reachable through their distribution systems. This will leave an equal amount of water in the canal for other users.

Recharge credits may be recovered during times of Colorado River water supply shortages, during planned or unplanned system outages when scheduled CAP deliveries cannot otherwise be made, or at any other time when recovery is beneficial to overall operation of the project. If, in the future, we decide that we have accrued more recharge credits than are needed, we may sell those in excess of our needs.

Financial Arrangement and Ongoing Projects

The CAWCD has nine projects on-going in 1992 with two different financial arrangements. The established price for CAP water to be used for recharge in 1992 is \$38/ac-ft which represents the incremental cost of \$36/ac-ft for energy to pump the water from the Colorado River to the delivery point and \$2/ac-ft for an administrative cost. This price does not include the related fixed operation and maintenance cost of \$16/ac-ft. In the most straightforward arrangements, the IDs have identified that their incremental savings for not pumping groundwater is about \$13/ac-ft. Consequently, CAWCD pays \$25 and the ID pays \$13 of the \$38 cost. The ID receives CAP water for use at approximately the same out of pocket cost as groundwater and enjoys the benefits of less pump use and a generally raised groundwater table when pumping is required. The CAWCD gains groundwater recharge credits for the cost of \$25 ac-ft with no capital cost outlay for recharge or recovery facilities.

In some more complicated arrangements that involve hydropower exchanges, the CAWCD pays the full \$38/ac-ft cost and delivers water to the ID at no cost. In turn, the ID purchases the hydropower equivalent to what would have been needed to pump groundwater and directs that hydropower to CAWCD. CAP water delivered to the ID using the ID's hydropower is paid for at \$16/ac-ft, the fixed O&M component of the CAP

water price. The CAWCD then markets the additional project power made available as a result of the exchange to enhance the overall revenue available to the CAWCD. One complicating factor for both parties is that the CAP requires about 1600 Kwhr to deliver one acre-foot and the participating IDs use about 850-1000 Kwhr to pump an acre-foot of groundwater. Careful recordkeeping is necessary to demonstrate that the proper amount of energy is scheduled to CAP and only that amount is credited to the ID for subsequent delivery of CAP water.

Table 1 provides a summary of the active projects in 1992, the expected water recharged through each project, and the cost to CAWCD.

Table 1 - CAWCD 1992 Actual and Projected Indirect Recharge Deliveries and Costs

Indirect Recharge Water Recipient	Max Annual Volume (AF/Yr)	Involves Power Exchange	CAWCD Cost	1992 Actual and Projected Indirect Recharge Deliveries (Acre-feet)												Total
				Jan	Feb	Mar	Apr	May	Jun	Jul	Aug	Sep	Oct	Nov	Dec	
CAIDD	110,000	Yes	\$38	0	123	1,659	4,174	4,208	7,916	11,982	0	0	0	0	0	30,062
		No	\$25	0	0	0	0	0	0	14,429	28,000	14,000	1,500	1,000	1,000	59,929
MSIDD	120,000	Yes	\$38	0	1,062	5,677	4,191	9,127	8,768	9,531	9,100	7,800	1,100	1,000	1,000	58,356
		No	\$25	0	0	0	0	0	0	14,185	11,200	12,200	4,400	1,500	1,000	44,485
RWCD	50,000	No	\$25	0	0	0	0	0	0	3,561	3,000	2,000	2,000	2,000	2,000	14,561
San Tan	5,000	No	\$25	0	0	42	58	367	549	516	850	625	300	250	100	3,657
Tonopah	15,000	No	\$25	0	0	0	1,142	2,373	2,417	2,838	2,750	1,000	500	0	0	13,020
Hohokam	40,000	No	\$25	0	0	1,919	1,849	1,960	4,609	7,113	10,000	2,400	0	0	680	30,530
Queen Creek	28,000	Yes	\$38	0	0	0	699	539	676	857	1,000	500	0	0	0	4,271
		No	\$25	0	0	1,794	1,976	3,442	4,094	4,040	5,000	1,500	200	100	100	22,246
Chandler IIs	3,000	Yes	\$38	0	0	0	120	134	142	160	140	130	140	100	50	1,116
		No	\$25	0	0	0	212	284	202	104	100	60	30	10	0	1,002
New Magma	40,000	Yes	\$38	0	0	0	0	1,971	2,429	0	3,100	2,400	0	0	0	9,900
		No	\$25	0	0	0	0	1,669	0	2,876	3,500	1,500	500	0	0	10,045
Total	411,000	--	--	0	1,185	11,091	14,421	26,074	31,802	72,192	77,740	46,115	10,670	5,960	5,930	303,180
Total CAWCD Costs				\$0	\$45,030	\$372,643	\$479,917	\$859,577	\$1,054,153	\$2,097,690	\$2,116,920	\$1,293,665	\$282,870	\$163,300	\$161,900	\$8,927,665

Includes actual deliveries through July 1992.

INSTITUTIONAL REQUIREMENTS

Prior to implementing an indirect recharge program, several institutional arrangements are necessary. After initial agreement with an ID, the first step is the state permitting process administered by the Arizona Department of Water Resources (DWR). The heart of this process is a sound engineering and operational plan that demonstrates that groundwater would have been pumped if the in-lieu project were not in operation. The plan must outline an accounting process which demonstrates the anticipated reduction in groundwater pumping. Some tools in this process include historic groundwater pumping records, cropping pattern, cropped acreage, crop consumptive use, electrical use records, and contracts for electrical power. Each project has its own unique arrangement. The DWR process includes a public notice process which provides opportunity for protest and for resolution of any controversy.

Where hydropower exchange is part of the project, it is necessary to develop an agreement with the supplier and scheduler of the hydropower. In the projects that CAWCD is operating, the Western Area Power Administration is the contractor for the hydropower to the IDs and is the power management agency for CAWCD. This agreement is necessary to ensure that the power allocation is not lost because the power is still being used to pump water to the land.

Appropriate agreements identifying the operating plan, recovery plan, costs, and accounting procedures must be developed between the indirect recharge project permittee and the water recipient.

CONCLUSIONS

Indirect recharge provides a comparatively low cost method of increasing the short term utilization of the CAP and providing long-term storage of available Colorado River supplies that would otherwise be lost to Arizona. An evaluation of current and projected economic conditions, water supply conditions, and anticipated water demand indicates that excess water supplies may be available for 10 to 15 years, but additional water supplies will be needed in 25 to 40 years. With the passage of legislation enabling the establishment of indirect recharge programs in 1990, CAWCD moved aggressively to implement a number of such projects in 1992. Nonetheless, water supplies and opportunities still exist. The main question is: "How much long-term storage can be justified (at what cost) in consideration of today's economic conditions?"

At whatever level determined to be justified, indirect recharge provides storage for long-term water supply, operational flexibility, and increased project utilization at the lowest cost when compared to surface storage, direct recharge, and development of new alternative water supplies.

**MITIGATING AGRICULTURAL IMPACTS
ON GROUNDWATER THROUGH DESALINATION**

William E. Warne¹

Neil M. Cline²

During the closing decades of the Nineteenth Century, there was a growing realization that Federal programs for the settlement and development of the Nation's western frontier were inadequate to overcome the problem of aridity in the lands beyond the 25-inch rainfall line which waveringly followed the 100th meridian.

The Homestead Act of 1862 had been successful in the settlement of the Plains States. In the dry valleys to the West, however, settlers seldom could comply with the five-year residency and development requirements in order to get the title to their homesteads. Not lacking in ingenuity, they diverted creeks and streams whenever they could reach them to water their crops. Contests, sometimes even gun fights, accompanied helter-skelter efforts by riparian land owners to divert water from the erratic streams. New concepts arose to govern the water developments, and old ones were modified to fit the circumstances. The diverter who was first in time became also first in right. The water was considered to be the common property of all the people, and rights attached only to its use. A water right extended indefinitely, so long as the water was being beneficially used in the place and for the purpose for which it had been acquired.

After 20 years of agitation in the western states and territories, Theodore Roosevelt, on coming into the Presidency in 1901, endorsed efforts to

1) Staffer of the Bureau of Reclamation in Washington D.C., 1935-1943 and Assistant Commissioner, 1943-1947. He was Assistant Secretary of the Interior for Water and Power, 1947-1951; and Director of the California Department of Water Resources 1959-1966.

2) General Manager, Santa Ana Watershed Project Authority (SAWPA), Riverside, California.

establish a national program. His support led to the Federal Reclamation Act of June 17, 1902. The Department of the Interior quickly organized the Reclamation Service, which later became the Bureau of Reclamation, and began the task of bringing order to western irrigation development by establishing at least one reclamation project in each of what are now the eleven western states. These projects, for the most part, were highly successful in regulating the water sources, and in founding sound agricultural communities among which towns and cities grew. The Service helped in the development of institutions such as irrigation districts, and the era of ditch bank shoot-outs was left behind.

After World War I, homesteads in the reclamation projects were in great demand among the returning servicemen. Frequently, scores of applicants competed for each plot that was open for settlement. Even the agricultural depression that set in during 1920 and led to defaults in settlers' repayments of their construction charges, did not dim the enthusiasm for the federal reclamation program. The Congress enacted moratoria on repayments, extended the repayment periods of the water users' contracts from 10 to 20, and then to 40 years. The Reclamation Project Act of 1939 added a ten year development period during which the construction charges, always to be repaid without interest, were postponed.

When in December of 1928, the Boulder Canyon Project Act was signed by President Calvin Coolidge the most ambitious river control project undertaken to that time was placed in the hands of the Bureau of Reclamation. This project broke ground in many fields. The Colorado River drained parts of seven of the eleven original reclamation states. Its flows varied from flood to drought in every year and its annual flows fluctuated by eight or ten magnitudes. It had entrenched itself in grand canyons so that its waters over hundreds of miles could not be reached by people on the rims.

The Bureau proceeded to design and build Hoover (nee Boulder) Dam, a structure without precedent in size, incorporating in the design and plan multiple uses of the water to be impounded in Lake Mead, a

reservoir of a capacity to conserve roughly twice the average annual flow of the river, in order to generate electric energy, supply municipal water to the Los Angeles Basin, Southern Nevada, and Central Arizona, and to protect downstream irrigation projects from flood and drought. The dam paid for itself in 50 years and has built a Colorado River development fund with the excess power revenues.

The Bureau's success put it in line for a major role in the development of the river basin projects in the West in the period of 1933 to the post World War II years, when it built the Central Valley Project in California, the Grand Coulee Dam - Columbia Basin Project in Washington, and the irrigation and power phases of the Missouri Basin development, the latter in cooperation with the Corps of Engineers, which would build the main stream dams. The opportunities for further developments in the West on the order of these, however, were being exhausted.

In 1950, the Bureau was flying high. Its reputation was near its zenith. Its staff experts were cooperatively loaned to design projects in China, Thailand, Jordan and elsewhere. But the Bureau domestically was confined to the West, and its leaders could see little challenge of scale ahead in that region but development of the Upper Colorado River. They were penetrating Alaska, and examining Hawaii, but programs demanding the full scope of the Bureau's expertise for various reasons did not seem imminent.

In the Summer of 1950, an interior official, returning to Washington from an assignment in Guam, was booked on a bucket-seat military transport that refueled on Johnston Island enroute to Honolulu. The refueling stop was extended by the necessity to make some minor repairs that took all afternoon. The Naval Officer who was in charge of the depot and airfield that covered most of the island, learned that his unexpected visitor had some jurisdiction over water programs of the Department of Interior. For want of something better to do, he ordered up a jeep and took his visitor to inspect the 50,000 gpd desalter that supplied fresh water from the sea. The desalter had rendered the desert island highly

useful as a refueling, and supply base during the Pacific War.

The Navy officer was used to shipboard desalters throughout his career, and thought nothing special had been done when the Navy brought the technology ashore at Johnston Island at the outset of the war. It was all in a day's work. The Interior official, however, was amazed at what he saw.

This was the time in the United States when anything seemed possible and nothing impossible. There were whispering that atomic power might be harnessed to electric generators and produce electricity at costs lower even than the initial rate set on falling water to be used in the generators at Hoover Dam, which was half a mill per KWh. The two technologies, desalination and atomic power, might be tied together to solve many of the water problems that Interior was wrestling with in the West, and that were beginning to appear in other regions of the Nation.

On arrival back at his desk in Washington, the official called together a group of department water experts. A task force was formed under Goodrich W. Lineweaver, an Assistant Commissioner of Reclamation, studies were begun, and in a few months a draft of an authorization bill for research and development of desalination technologies was produced.

By the time the bill was cleared by all of the reviewing agencies and considered in the various committees in the House and Senate, some more realistic appraisal of the chances to obtain virtually free electric energy from atomic fission, and thereby make the water produced by energy-intensive desalting processes cheap enough to use in irrigation, had begun to appear. Nevertheless, Public Law 448, 82nd Congress, Chapter 568-2nd Session, as approved by President Harry S. Truman on July 3, 1952 retained the production of irrigation water for agriculture as the leading objective of the new program that it placed in the Department of Interior. The initial appropriation of \$125,000 to finance the program was made during the 1953 fiscal year.

A new Secretary placed the water research and development unit in his office, not in the Bureau of Reclamation. This unit became the Office of Saline Water, later the Office of Water Research and Technology, and nurtured other desalination technologies to go with distillation. Its work attracted world-wide attention. It is rightfully credited with the inspiration of the development of the Persian Gulf desalters that supply potable water to all of the cities along the South Shore of the Gulf and those bordering the Red Sea. The desalting boom that has placed reverse osmosis plants in most of the municipal water distribution systems of the cities on the coasts of Florida can be credited to the program, although the OWRT was phased out a decade ago, and its diminished remnants scattered in other interior agencies.

The Bureau of Reclamation had little part in the interior's desalination push, but when the controversy over the quality of Colorado River water that the United States was delivering to Mexican irrigators became a threat to peace along the border, responsibility for the design, construction, and operation of the world's largest reverse osmosis desalination project at Yuma, Arizona, was placed in the Bureau. The Colorado River historically has been the Bureau's charge. The Water Treaty of 1944 between the United States and Mexico, fixed the quantity of water that the United States must deliver to Mexican water users at roughly 1,500,000 acre feet per year. The language was not clear on the subject of the quality of those waters; at least the quality provisions were differently perceived.

Degraded drainage water was pumped from the groundwater aquifers under irrigated lands of the Bureau's Wellton-Mohawk Project at the lower end of the Gila River basin directly into the Colorado River below Imperial Dam. During periods of low flow in the Colorado River these brackish drain waters elevated the salinity of the water delivered to Mexican users to levels that the irrigators said damaged their crops. Protest riots followed in Mexicali. A State Department study brought a "definitive solution" which involved extending the Wellton-Mohawk drain paralleling the river channel clear to the Gulf of California, and, in order to

preclude the loss of the use of most of the drain waters, which were needed to fill out the allocations of water that had been made to both United States water users and to those of Mexico, the report recommended a giant desalter.

The report led directly to the Colorado River Salinity Control Act of 1964, which directed the Bureau to construct the desalter. After 18 years, the desalter in 1992 has begun operating at about one fourth of its capacity. A part of the delay in completing the great facility and beginning desalination of the drainage water was due to a period of high flows in the Colorado River which made the wastage of the drainage water of no significance to the managers of the river, especially since the diversions into Central Arizona had not yet begun. Requirements of the treaty were readily met during the wet cycle without the expense of operating the desalter.

Nevertheless, the Yuma Desalter was the first employment of the desalination technologies in mitigation of water problems incidental to irrigated agriculture. The treaty obligations, and the hostility engendered in Baja, California towards the United States irrigators, who were their nearest neighbors, may have motivated the Congress, but, the Bureau was finally using the new technologies as an element in its traditional western water management program, as had been anticipated in 1950.

Another and far more pervasive influence on water resources development, whether in the arid West or elsewhere in the Nation, has been the sensational rise in the influence of environmental concerns. Environmental activists have successfully challenged and, in instances, upset such time-honored precepts as first in time is first in right, extension of water rights so long as the water is beneficially used, and the primacy of municipal users and irrigators in the pecking order among water users. The very foundations of some State and Federal water projects in the West have been shaken by the application of the doctrine of Public Trust in the Mono Basin litigation seeking to curtail long-established diversions by the cry of Los Angeles streams feeding the saline sink. For more than a

decade in California, new water developments, planned for the Central Valley Project and the State Water Project have had to be shelved. Released of stored water during drought periods to mitigate environmental and fishery problems have been made at the expense of shorting water deliveries under contracts with municipal and agricultural water users. These contracts of long standing are the bases of the repayments that make the projects economically feasible.

Sea water desalination has been turned to by an increasing number of coastal towns and cities in California as a result of the impacts of the drought, now in its sixth year, unbridled population growth, which has outrun the developed water supplies, and the reallocation of project water to fish and wildlife and other environmental uses.

Concomitantly, overused groundwaters have been degraded, by seepage of agricultural wastewaters into the aquifers from which both municipalities and farmers pump. In instances, health officers have been forced to close down wells.

A new order of desalination plants using membrane processes has begun to appear in such places as the Santa Ana Watershed in Southern California and the Salt River Valley in Arizona. It seems that after all desalination technologies may have a significant place in preserving and further developing irrigation in the West. Desalting sea water for coastal populations averts demands for exchange of water from agricultural users; a practice growing in popularity despite dangers inherent in cannibalizing farm communities. The appearance of toxic elements in groundwater basins that have been used for community services present critical problems, not only in the West, but widely in industrialized regions of the Nation. Desalters can restore these waters.

Reclamation Commissioner Dennis B. Underwood, in testifying before the Senate on Environment and Public Works on Senator Paul Simon's S. 481 last year, gave his enthusiastic support to reauthorization of a revival of research in and development of desalination and other advanced water

technologies to meet the emerging problems associated with water quality. In Section 2, the Declaration of Policy in the Simon bill closely follows the statement in the original 1952 Act. It places uses of the water sciences for agriculture first. The Commissioner said the Bureau was now ready to press forward with demonstrations of how desalting could help meet currently developing water supply problems in the West. When questioned, he said that the Bureau was also prepared to carry the program to other parts of the country where needs are frequently great. The urge to escape the western regional cage remains.

Just as Hoover Dam propelled the Bureau of Reclamation into the forefront of the era of vast river basin developments, the Yuma Desalter may serve to make the Bureau the leader in the new era of water development.

Here are thumbnail case histories of some of the new order of desalination projects that are making their appearance in this decade in the Pacific Southwest.

Groundwater resources have been and remain the most reliable water supply throughout Southwestern United States. Historically groundwater was the only source of supply for most of the 100 years of active farming that has occurred in this region. However, as urbanization has occurred, particularly in Southern California, there has emerged a problem with groundwater quality attributed primarily to agricultural practices, landfill operations, industrial programs, wastewater discharge and sea water intrusion. The accumulation of total dissolved solids (TDS) and nitrate in addition to volatile organic compounds in the groundwater supply has caused thousands of wells to be abandoned. Continuing degradation is expected to occur as contaminants in the vadose zone are leached to the water table, or are conveyed as plumes in subsurface flow.

In the arid southwest, where competition for available water resources has always been intense, the potential loss of any water resource is unacceptable. The Metropolitan Water District of Southern California (MWD) in an aggressive program

to control the pervasive diminution of supply has introduced its "Groundwater Recovery Program" to assist local agencies in combating the loss of groundwater reserves. The Groundwater Recovery Program provides that if a local water agency constructs a groundwater recovery system to salvage brackish water, MWD will purchase the supply and will pay, in 1992-93 up to \$572 per acre-foot for the water. MWD will in turn market the water to its customers at the wholesale rate of \$322 per acre foot, so that the local user pays the same as if the water were imported from Northern California or the Colorado River. Under this program MWD buys high and sells low. Metropolitan expects to expand this program to 200,000 acre-feet per year in the next decade.

This innovative and progressive program has stimulated the consideration and implementation of many new brackish water desalting systems in recent months. Some examples:

ARLINGTON DESALTER, Riverside, CA

The Arlington Basin contains about 300,000 acre-feet of water degraded by agricultural leachate from historic citrus grove operations. The average quality of the supply is 1100 mg/l TDS and 90 mg/l Nitrate. Because of the quality, all pumping has been discontinued which will result in impaired groundwater seeping to the surface and draining to the Santa Ana River and elsewhere, thereby contaminating downstream and adjacent water supplies.

The Santa Ana Watershed Project Authority (SAWPA) a joint powers agency of 5 local water districts that manage the water resources of the Santa Ana River, has constructed the Arlington Desalter facility. This plant is designed to produce 4000 acre feet of desalted supply that is blended with 2000 acre feet of untreated groundwater to yield a total of 6000 acre feet per year of potable supply available for direct groundwater replenishment uses.

The facility is a reverse osmosis plant fed by 5 wells. The brine is discharged to the Santa Ana River Interceptor, an industrial discharge line that is tributary to Orange County's treatment works, where the brine is commingled with local waters, and ultimately discharged to the Pacific Ocean. The average cost of the desalted water: \$400 per acre foot.

TUSTIN DESALTER, Tustin CA

The City of Tustin, CA has lost six wells in the last several years to excessive nitrate and TDS. In cooperation with the Orange County Water District (OCWD) the City has installed an ion-exchange system and a Reverse Osmosis desalting plant operating from water supplied by the impaired wells. The annual production for domestic use is about 3500 acre feet per year at a cost of \$500 per acre foot. A second stage of this program is currently in design stage and will add another 3200 acre feet of water to the city's drinking water supply. The proposed facility will use reverse osmosis technology to treat impaired water supplied by three wells. The estimated cost of the product water is \$480 per acre foot. The new plant is anticipated to be under construction in 1993 and on line in 1994.

IRVINE DESALTER, Irvine CA

The vast Irvine Ranch area of Orange County, California has been intensely farmed for over a century. In the early years the ranchers relied upon local groundwater, and since the early 1950's have used large quantities of imported Colorado River water for irrigation to raise both citrus and a wide range of row crops.

A combination of heavy fertilization, irrigation with relatively high (600-700 mg/l TDS) mineralized Colorado River water, and recent contamination, including TCE, believed to have originated from several military installations on the Ranch, has caused the OCWD and the Irvine Ranch Water District to enter into an agreement to construct, operate and, in cooperation with MWD, fund a 6700 acre foot

per year desalination facility. The desalter is expected to cost about \$30.0 million, and will provide potable water for local use for an estimated \$600 per acre foot. Anticipated completion date is 1995.

SAN JUAN CAPISTRANO, CA

The San Juan Basin in South Orange County California was at one time pumped heavily to support citrus and field crops. Naturally occurring groundwater quality was marginal, and has further degraded with time due to the agricultural return percolation. The current quality in the ranges from 2000 mg/l adjacent to the Coast to 350 mg/l in the upper basin area. A management plan to utilize the basins storage capacity in conjunction with artificial and natural recharge has been devised. It is planned that up to 5000 acre feet per year will be pumped in the lower basin which will cause some controlled sea water intrusion. The water will be desalted using reverse osmosis technology and used for potable purposes in the San Juan Capistrano area. The management plan anticipates that on an emergency basis, the short term yield of the basin will be increased to 10,000 acre feet per year. The plant is expected to be on line by 1994. Estimated costs of product water \$550 AF.

OCEANSIDE, CA

The City of Oceanside, California in San Diego County is planning to construct a 2.0 MGD desalination facility to salvage impaired groundwater that has degraded as a result of agricultural activity. The site design work has been completed, the production and monitoring wells have been constructed and site preparation has begun. The bids to construct the proposed reverse osmosis plant are expected to go out in the fall of 1992. Estimated water cost: \$400 AF.

CHINO, CA

The lower Chino Basin, in San Bernardino County, California is the location of the largest concentration of dairy stock in the United States. There are currently 300,000 dairy cattle occupying about 15,000 acres. The mix of historic agricultural activities in the Chino Valley and the on-going dairy operations has resulted in widespread loss of local groundwater resources to TDS and nitrate. To prevent further deterioration of local supplies and to protect the nearby Santa Ana River, SAWPA is preparing to construct the Chino Desalination System. The project will include two 6.0 MGD desalination units using either reverse osmosis technology or an electro dialysis reversal process. The quality of local groundwater ranges from 800 mg/l TDS to 1100 mg/l TDS and nitrate from 50 mg/l to 300 mg/l. The treated water about 12,000 acre feet per year will be utilized by nearby cities to offset imported water requirements. The estimated cost of the project is \$48.0 million. The product water will cost an estimated \$570 per acre-foot. The plants and support systems are presently being designed, and are expected to be on line in 1994.

**AGRICULTURE'S IMPACT ON WATER RESOURCES
IN EASTERN EUROPE:
BULGARIA, HUNGARY, AND ROMANIA**

James M. Wolf¹

ABSTRACT

Irrigation and other agricultural practices have had a profound impact on the environment in Eastern and Central Europe. The focus here is on water resources, the impact of irrigation on the environment, and the impact of agriculture on surface water and groundwater. Main impacts have been:

- Environmental degradation resulting from irrigation's heavy reliance on energy for lifting and pressurizing the water; and
- Degradation of surface water and groundwater from various sources, including agriculture. Agriculture's impact derives primarily from feedlots and from non-point sources such as fertilizers and pesticides.

Increases in prices for fertilizers, pesticides, and energy will generally have positive impact upon water resource quality, and on the environment.

BACKGROUND ON THE IRRIGATION SECTORS

Countries in Eastern and Central Europe have large irrigation sectors (see Table 1). The command area in Romania compares in size to that in California; Bulgaria can irrigate an area similar to that in Colorado; the irrigation command in Hungary can be compared with that in Arizona. Unlike the situation in the western United States, Eastern European irrigation is largely supplemental. Sprinkler irrigation is the dominant mode of application.

¹ Senior Irrigation Specialist, Development Alternatives, Inc., Sacramento, California

TABLE 1

IRRIGATION SECTORS IN BULGARIA, HUNGARY, AND ROMANIA

	BULGARIA	HUNGARY	ROMANIA
Cropped Area (ha)	4,600,000	4,700,000	10,000,000
Area Commanded by Facilities (ha)	1,200,000	400,000	3,200,000
Irrigated Area (ha)	930,000	290,000	2,500,000
Sprinkler Irrigation (%)	45	75	87
Average Head (m) (elevation + pressure + losses)	130	65	145

ENERGY DEPENDENCE

The irrigation sectors in Bulgaria and Romania are highly dependent on energy. Most water used for irrigated agriculture must be lifted several times before it can be applied to the land. Romania pumps 80 percent of its irrigation water from the Danube River; the water is lifted several times before it is in position to use in agriculture. Bulgaria obtains about 20 percent of its irrigation water from the Danube, again through a series of lifts. Other smaller rivers supply water for irrigation, but this also must be lifted into offstream storage reservoirs (there are over 800 in Bulgaria) prior to application. This is quite unlike the situation in Northern California, where water is stored in the mountains and flows by gravity to irrigate lands below.

Eighty-seven percent of Romania's irrigated area is irrigated by sprinklers. In Bulgaria, about 0.5 million hectares — 45 percent of the irrigated area — rely on sprinkler irrigation. Sprinkler methods typically require pressurization equivalent to 35 meters of head for successful on-farm application.

The electromechanical systems (pumps and motors) used are notoriously inefficient. Romanian authorities estimate electromechanical efficiency at 59 percent. Breakdowns are frequent. Leakage is common, and much water must be repumped. Hydraulic efficiency was estimated by Romanian authorities at 40-70 percent, which may not be much different from systems in other countries.

The combination of lifting and pressurization results in an average energy expenditure for the country estimated at 130 meters by Bulgarian Ministry officials. Irrigation consumes 14 percent of all energy used by the agricultural sector.²

Romanian authorities have estimated energy expenditures for irrigation at 145 meters.³ Assuming an average water application of 0.232 meters per hectare over 2.5 million hectares, a volume of 5,800 million cubic meters will be required. Power requirements are estimated at 3,900 million kilowatt-hours per year, or approximately 5.5 percent of Romania's electrical power consumption.⁴

If energy production leads to pollution problems — and it clearly does — then irrigation's demand for power in Bulgaria and Romania contributes to pollution. Eighty-two percent of Romania's electrical power comes from burning coal and hydrocarbons.⁵ Power production that uses coal and hydrocarbons degrades the environment. Irrigation's dependence on energy in these two countries fuels this degradation.

Factors that contribute to huge energy expenditures should be examined in an effort to reduce energy dependence. There may be opportunity to reduce lifts if the governments adopt programs to support development of small-scale local water-supply sources (small streams, springs, and groundwater). These programs may favor land privatization and property downsizing. Because of scale considerations, little attention was devoted in the past to developing small-scale local sources.

Opportunities to reduce dependence on sprinkler irrigation would also reduce energy demands. If investments were made in land leveling, on-farm applications could be done by means of gravity. Micro-jet and drip irrigation are two other application

² *World Energy Statistics and Balances, 1985-1988* edition, International Energy Agency, Paris, 1990.

³ Institute for Studies and Design of Land Reclamation Projects.

⁴ Commission Report on Irrigation and Drainage, 1990-1991.

⁵ Romanian Electricity Authority Report for 1990.

methods that consume less energy than sprinkler irrigation.

Energy efficiency can be improved by upgrading pumps and motors, replacing inefficient equipment, and investing in conveyance facilities to save water. A World Bank loan for Romania has been approved to fund an irrigation and drainage study establishing priorities for the subsector. The loan will enable the country to upgrade certain irrigation systems.

Based on prevailing energy prices in the world market, costs are about \$0.30 per 1000 cubic meters per meter of head — or about \$40 to lift and pressurize 1000 cubic meters (assuming combined energy requirements of 130 meters).⁶ If a crop requires an irrigation application of 23 centimeters, the energy costs to supplementally irrigate one hectare are calculated at \$92. Although these costs are not unusual by U.S. standards, agricultural users in Bulgaria currently pay a set fee of about \$1.40 per hectare per year plus a volumetric charge of \$0.11 per 1000 cubic meters, or about \$1.65 to irrigate one hectare. Such pricing fails to recover power costs, let alone charges for maintenance or for recovery of capital costs.

The primary issue in irrigation is efficiency — not the common problem of efficiency of water delivery and conveyance loss, but rather efficiency of energy use. This is not an argument to levy higher water charges upon users; they simply will not be able to pay these higher charges. Rather, the case is made that Bulgarian and Romanian irrigation is inherently energy-intensive, and some person or some entity ultimately has to pay the bills.

SURFACE WATER POLLUTION

Throughout the region, water pollution is a major concern. The Romanian Ministry of the Environment estimates that, of wastewater returned to rivers and streams, only 10 percent is adequately treated, 60 percent is partially treated, and 30 percent is discharged without treatment. According to Ministry sampling of monitored river lengths, 39 percent falls

⁶ Converted from figures provided in Keller, Jack, and Ron Bliesner, *Sprinkle and Trickle Irrigation*, Van Nostrand Reinhold, 1990, p. 18.

nto the top category of water suitable for drinking with only minor treatment, 30 percent falls into a category requiring moderate treatment, 12 percent equires a high degree of treatment, and 18 percent is unfit for most uses.

Industrial and Urban Wastes

ontamination from toxic industrial wastes discharged o rivers is a high-priority concern throughout the egion. The principal contaminants are organic aterials, heavy metals, ammonia, and suspended solids. roblems are evident even to a casual observer: the requency with which industries discharge effluent to streams; color changes in rivers; and floating debris, ils, and foams. The World Bank, the European Bank for econstruction and Development, and others will provide upport to help countries clean up some of the most olluted rivers. One less-known but more insidious roblem is the discharge of radioactive leakage from ulgaria's nuclear power plant at Kozloduy into the rainage system of the Asparuhov Val irrigation system and from there into the Danube.

nother priority concern is the discharge of partially reated municipal sewage from large cities such as ucharest, Budapest, and Sofia, and from smaller cities s well. International funding has been targeted for onstruction of water treatment plants for Budapest and ucharest.

Agricultural Pollution from Feedlots

griculture's contribution to surface water pollution as been less obvious, but substantial. Livestock eedlots are the principal agricultural source of urface water pollution. It is not coincidental that eedlots have been concentrated along major waterways ecause, typically, raw or partially treated effluent rom feedlots is discharged to rivers and streams.

n Bulgaria, 5,400 feedlots discharge an estimated 33 illion cubic meters of wastewater per year, creating a emand for water equivalent to 10 percent of municipal nd industrial water supplies for the country. Two-hirds of the feedlots do not meet environmental tandards. Most of the feedlots have experienced ecurrent problems with the treatment technologies they mploy and, at times, wastes cannot be treated or ontained.

In Romania, large livestock feedlots — each with more than 30,000 animals — discharge an estimated 125 million cubic meters of effluent per year, about the equivalent in volume to sewage effluent expected from a U.S. city with a population of one million. Swine wastewater has 3-4 times the Biologic Oxygen Demand (BOD₅) content of domestic wastewater. On a per capita basis, and allowing for average body weight, each pig produces about double the quantity of organic waste that a human produces.⁷ If the amount of organic waste produced by the 7.2 million swine on large feedlots is compared with that produced by the city of Bucharest, we find that there is five times more organic pollution generated by swine feedlots than by Bucharest. It was estimated that less than five percent of the large swine complexes meet effluent standards (100 milligrams/liter) for BOD₅ discharge.⁸ Also contained in the wastes are large quantities of suspended solids, nitrogen, phosphorus, potassium, and pathogens.

GROUNDWATER CONTAMINATION

Severity of the Nitrate Problem

Groundwater in Romania is heavily contaminated with nitrates. Shallow groundwater is unfit for drinking, exceeding the Romanian (and U.S.) standard — 10 parts per million of Nitrate-N or 45 parts per million of nitrates — in 40 percent of the cases. One survey, done in 1988 by the Institute of Public Health, covered 12,554 rural wells in 2,720 villages throughout the country. It showed 36 percent of the wells contaminated with nitrate concentrations exceeding the standard.⁹ Nitrate concentrations were worst in irrigated agricultural areas of the country. A second

⁷ Pigs weighing 35 kilograms produce about 105 grams of BOD₅ per head per day; adult humans produce 54 grams of BOD₅ per capita per day. Source: Donald L. Day, *Report on Visit to Romania, May 26-June 6, 1975*, UNDP Report: Romania 3102, 1975.

⁸ Environmental Research Engineering Institute, Bucharest.

⁹ Cuca, M., Liliana Ursa, Ioana Iacob, and I. Petra, "Determination of Nitrate Levels in Groundwater in Rural Areas of Romania with an Appreciation of Public Health Aspects," *Caiet Metodologic I*, 1990.

urvey, by the Irrigation and Drainage Research Institute in 1991, reported on analyses of 850 groundwater samples from irrigation systems. Forty-one percent of the samples contained Nitrate-N concentrations in excess of 11.3 parts per million.

Bulgaria, the situation is similar. In three regions of the country, the ten-year average concentration of Nitrate-N was 16 to 22 parts per million. In these regions, it is estimated that 70-80 percent of the population is exposed to drinking water that contains too much nitrate. In eight other regions of the country, 35 to 45 percent of the population uses drinking water with above-standard concentrations of nitrates. In the remaining eight regions of the country, 2 to 30 percent of the population is similarly posed.

Put the nitrate contamination problem into perspective, we can make comparisons with analyses carried out on groundwater in the United States. U.S. Geologic Survey sampling of 124,000 wells over 25 years revealed that only 6.4 percent had Nitrate-N concentrations in excess of 10 parts per million. An A survey, published in 1990, of 1,350 groundwater sources showed that only about two percent of the wells exceeded the standard.¹⁰

Over five million Romanians rely on wells as their source of drinking water. High concentrations of nitrates in drinking water can be fatal to babies under three months of age. The Romanian Institute of Public Health estimates that each year 150-200 Romanian infants develop methemoglobinemia, or "blue-baby syndrome," which is caused by an excess of nitrates in drinking water. Nitrate pollution is much more widespread in Bulgaria and Romania than in Hungary. In fact, even in Hungary, dozens of cases of methemoglobinemia, including some deaths, are reported each year.

Causes of and Solutions to the Problem

Hotspots, discussed above, are one likely main point source for nitrogen in groundwater in Bulgaria and Romania. Bulk handling of fertilizers may be another point-source contributant. Other non-agricultural

¹⁰ Nitrate Occurrence in U.S. Waters, USDA, Washington, D. C., September 1991, p. 2

sources for nitrate contamination include human waste, vehicle discharge, and industrial pollutants.

Nitrates also enter groundwater from non-point sources such as nitrogenous fertilizers. In the centrally planned economies, the supply of fertilizer to state farms was closely geared to crop requirements.¹¹ However, because average yields were low — for example, Romania realized only 2.8 tons of maize per hectare and 3.2 tons of wheat per hectare — the crops failed to extract all the fertilizer that was applied, and a portion of the nitrogen ended up in the groundwater. In Romania, over the 11-year period from 1980 through 1990, it is estimated that 500,000 metric tons of nitrogen were applied in excess of crop requirements and were lost to ground and surface water. In Bulgaria, it was estimated that application of nitrogenous fertilizer exceeded uptake by 37 percent.

Groundwater Contamination from Organics and Heavy Metals

Data from Bulgaria and Romania show scattered evidence of organic and heavy metal contamination of groundwater. For example:

- Chlorinated hydrocarbon residues in groundwater tend to be in the nanogram range (10^{-9} grams per liter). This is considered an acceptable background level. Bulgaria banned use of chlorinated hydrocarbons in 1967; Romania banned their use in 1984.
- Organophosphates are sometimes — though rarely — reported in groundwater. Concentrations are very low — less than one microgram per liter. Where a problem exists, it has been associated with a specific point source of application.
- 2,4,D has been found in groundwater and surface waters at concentrations on the order of 10^{-8} to 10^{-7} grams per liter. Insofar as drinking water standards are concerned, Bulgaria does not permit any concentration of pesticides in water.

¹¹ During the 1980s, the average amount of nitrogen applied through chemical fertilizers was 108, 120, and 75 kilograms per hectare in Bulgaria, Hungary, and Romania, respectively.

- Triazine, Atrazine, and Simazine have not been detected in Bulgarian groundwater, but in Romania, Triazine and Atrazine have been found in groundwater near the herbicide manufacturing plant at Pitesti.
- Lead and cadmium have been encountered in groundwater near Bulgarian chemical plants in Vratza, Smolen, and Mihailovgrad.

In none of the countries is groundwater quality testing widespread nor is it done with regularity. Although organic compounds and heavy metals have been detected in groundwater in Bulgaria and Romania, the Hungarian Ministry of Agriculture states that pesticide levels in groundwater, soils, and plant material are far lower than limits set for health protection.¹² Against this attention is the fact that pesticide use in Hungary — 7 kilograms of active ingredient per hectare per year — is 40 percent higher than in Romania or Bulgaria. Light-textured soils and intense agricultural activity in central Hungary, between the Danube and Tisza rivers, make this area particularly vulnerable to groundwater contamination.

NATIONAL AND INTERNATIONAL RESPONSES TO THE PROBLEMS

Strapped for funds, the Eastern European countries are not paying much attention to environmental concerns. Furthermore, the ministries of the environment in these countries tend to be newly established and therefore weak in comparison with the ministries of industry.

The European Community, the European Bank for Reconstruction and Development, and the World Bank are interested in making loans to countries in this region for environmental clean-up. The World Bank has prepared Environmental Sector Strategies for Bulgaria and Romania, and will make loans to these countries for environmental programs. Priority concerns are nuclear safety and industrial clean-up. Relative to the urban and industrial sectors, agriculture is not a priority for environment-related funding.

¹² Fesus, I., et al., *The Environmental Impacts of Agriculture in Hungary*, Ministry of Agriculture, Budapest, 1991

The U.S. government's response has been very weak. Numerous missions have occurred, yet few agricultural programs are in place. There has been intense rivalry between USDA and A.I.D. over which agency will represent the U.S. government in programs related to the agricultural sectors in the region. USDA is unable to think beyond a seminar circuit and a series of Best Management Practices demonstration plots; A.I.D. is more concerned with economic restructuring and privatization than with environmental issues. And with new funding demands for programs for the former Soviet Union, funding for agriculture/environmental programs in Eastern Europe was recently cut by 90 percent.

POLICY CONCERNS AND PRICES

Following their transition to market economies, all the Central and Eastern European countries instituted marked price increases for fertilizers and pesticides. As a result, use of nitrogenous fertilizers in Romania, decreased from 75 kg/ha during the 1980s to 15 kg/ha in 1991. Bulgaria and Hungary also cut back on fertilizer use, though not so dramatically. If nitrogenous fertilizer use remains low, this is likely to have a positive impact on nitrate levels in groundwaters.

However, the solution to the non-point source nitrate problem is not to cut back on fertilizers. Their rate of use in Bulgaria and particularly in Romania are already among the lowest in Europe. If yields can be increased, nutrient uptake will also increase and, with better production levels, an economic base will be in place to support environmental improvement. Cutting back on fertilizer inputs weakens the possibility for creation of an economic motor behind environmental improvement.

Best Management Practice Programs (of fertilizers) have been recommended by some as a way to address problems of nitrate contamination. Instead, the first priority should be directed to contamination generated by feedlots, for these represent a significant part of the problem — and dealing with point-source contamination will have a larger return in the short term.

Similarly, pesticide price increases have resulted in a decrease in pesticide use and a decreased probability of chemical residues in waters.

energy price increases will have a positive impact upon the environment. Highly subsidized energy prices remain a disincentive to increasing efficiencies in irrigation systems. Also, if the price was right, large livestock enterprises would be encouraged to convert current problems of livestock waste treatment and disposal into opportunities for biogas and energy production.

NONPOINT SOURCE POLLUTION: AGRICULTURE AT RISK - REAUTHORIZATION OF THE CLEAN WATER ACT

Thomas F. Donnelly ¹

ABSTRACT

Scientific studies and testing suggest that nonpoint source² pollution of our Nation's lakes, rivers, and streams is, today, the number one cause of water quality degradation. Agriculture is considered by some as the single most serious problem area. Until 1987, the federal government, states, localities, and the private sector have concentrated their financial and technical resources on addressing point source³ pollution. The Clean Water Act Amendments of 1987 for the first time attempted to address the more difficult problem of nonpoint source pollution.

Early next year, the 103rd Congress will attempt to reauthorize the Clean Water Act. One of the paramount issues to be addressed in this reauthorization is the management and control of nonpoint sources of pollution. From the standpoint of continued economic viability, agriculture and livestock operations are clearly at risk. The basic choices are quite simple. The ultimate approach to solving the nonpoint source problem will be either one based on voluntary technical assistance-incentives approach or a strict regulatory approach using "ecological integrity" as a yardstick.

This paper will examine both alternatives and present a case in favor of the voluntary-technical assistance-incentive based approach.

INTRODUCTION AND BACKGROUND

On January 3, 1993 the 103rd Congress of the United States will attempt to reauthorize the Clean Water Act as one of its highest priorities. Clearly, addressing the problem of nonpoint source pollution particularly from agriculture and livestock operations will be of primary importance. Agricultural operations nationwide are at risk as Congress and the Nation turn their attention to better management and control of nonpoint sources of pollution.

The Federal Water Pollution Control Act of 1972 (PL 92-500, commonly called the Clean Water Act) has been an incredibly successful environmental statute. Considering the state of our Nation's waters when the Act was passed, the

¹ Executive Vice President, National Water Resources Assn., Arlington, VA

² Rodgers, William H. Jr. Environmental Law. West Publishing Co. 1984. p. 375. a "point source" is "any discernible, confined and discrete conveyance, including but not limited to any pipe, ditch, channel, tunnel, conduit, well, discrete fissure, container, rolling stock, concentrated animal feeding operation, or vessel or floating from which pollutants are or may be discharged." Not defined in PL 92-500.

³ 33 U.S.C. A. § 1362 (14) A nonpoint source is and source of water pollution not associated with a discrete conveyance.

"fishable, swimmable" goals of the Act were immensely ambitious. We have made incredible progress in many areas improving the quality of our Nation's waters. This progress has, however, required a tremendous financial commitment on the part of the American taxpayer and industry. In twenty years the federal, state, and local governments, combined with industry, have spent over \$140 billion (federal funding accounts for approximately \$50 billion) in an effort to achieve the "fishable and swimmable" goals of the Act. Note that virtually all of this funding has been dedicated to controlling pollution from point sources. Admittedly, the goals and objectives of the Act have not entirely been met. Today, 30 percent of all assessed river and stream miles fail to fully attain designated water quality. Twenty five percent of lakes are impaired and an additional 20 percent are threatened by pollution.⁴ A 1988 report on the quality of our Nation's waters by the U.S. Environmental Protection Agency (EPA) indicated that nonpoint pollution is the source of the remaining problem for 76 percent of the impaired lake acres, 65 percent of the impaired river and stream miles, and 45 percent of the impaired estuary square miles.

The Water Quality Act of 1987 added a new section (Section 319) to the Act to address all aspects of nonpoint source pollution. Until the 1987 Amendments, nonpoint sources of pollution were virtually exempt from the regulatory requirements of the Act and enjoyed a somewhat uncertain legal status. In any event, the focus of the statute for fifteen years and the resulting regulatory program was solely the control of point sources of pollution. In fact, EPA's "Water Strategy Paper," published April 30, 1973 concedes "nonpoint source activities will not be oriented at first towards aggressive control and enforcement."

The 1987 Amendments authorized \$400 million to implement the management programs for nonpoint source pollution under Section 319. To date, only a small fraction of that amount has been appropriated.

NONPOINT SOURCE POLLUTION AND THE ACT: SECTION 319

Section 319 of the Clean Water Act required each state to prepare an assessment report identifying those navigable waters which are impacted or threatened by nonpoint source pollution and the sources of pollution for each portion of the navigable waters identified.

The state assessment reports varied greatly in quality, detail, and content. However, the data provided a relatively comprehensive mosaic of the magnitude and effects of nonpoint source pollution throughout the Nation. According to EPA's analysis of the state assessments, agriculture is the Nation's largest contributor to nonpoint source pollution. In fact, states attributed 41 percent of their nonpoint source problems to agriculture.⁵ This is not a new reevaluation, A Soil Conservation Survey study in 1971 estimated that agriculture is responsible for

⁴ U.S. Environmental Protection Agency. 1992. Managing Nonpoint Source Pollution. Washington, DC.

⁵ Ibid

50 percent of the total sediment contaminating U.S. inland waterways, and that half of this reaches the oceans carrying with it a wide range of organic and inorganic contaminants.

Section 319 further required each state to prepare and submit to the EPA Administrator for approval a management program for nonpoint source problems identified in the state's assessment report. Fundamentally, the management programs were required to: a.) identify best management practices (BMPs) and measures that would be adopted to reduce pollutant loadings from nonpoint sources, b.) identify programs to achieve implementation of BMPs, c.) identify sources of federal and other funding to support control activities, and d.) identify federal projects and programs that will be reviewed for consistency with the management plan. Today, every state has submitted its management plan for EPA approval and the Administrator has approved all but two of the plans. In its final report to Congress on Section 319, "Managing Nonpoint Source Pollution," EPA praises the accomplishments of the states in identifying and developing management plans as required by Section 319 of the Clean Water Act. Privately, however, sources within EPA, USDA, and USGS estimate that only about 10 percent of the plans are credible. This fact alone has prompted some lawmakers in Congress to support abandoning the Section 319 program in favor of a strict regulatory approach.

SENATE BILL 1081: REGULATORY APPROACH BASED ON "ECOLOGICAL INTEGRITY" STANDARDS

On May 15, 1991, Senator Max Baucus (D-MT) introduced Senate bill 1081, a bill to reauthorize the Federal Water Pollution Control Act. In his floor statement introducing the legislation Baucus stated, "The bill builds on the existing nonpoint control program in section 319 of the Clean Water Act. Funding for State nonpoint source control programs is expanded substantially, and EPA is directed to define minimum elements of approvable State programs. Other amendments related to nonpoint source pollution control would provide new authority for management of nonpoint pollution sources on Federal land, targeting of agriculture assistance programs to State identified water quality problem areas, better management of commercial fertilizers and funding of the Rural Clean Water program."⁶

In reality S. 1081 rather than building on the existing 319 program would, if enacted, change the scope and direction of the program from a state-managed incentive-based program to a program of strict "enforceable management measures" for agriculture controlled by EPA.

Section 15 of S. 1081 is the primary section relating to the management and control of nonpoint sources of pollution. This section is vague and quite ambiguous; however, it clearly is directed at agriculture and it leans heavily towards pollution prevention by "enforceable management measures." The bill identifies sediment and discharges from "hydromodifications" (i.e., dams and diversions) as pollutants

⁶ Congressional Record. Vol. 137, Wednesday, May 15, 1991, No. 73, p. S5904
U.S. Government Printing Office

and would require EPA to promulgate new mandatory national management measures for them and for fertilizers, pesticides, and sediments. It shifts the program focus from state established best management practices to federal technology-based standards. These national technology-based standards would be developed by EPA and uniformly applied across the country without regard to regional differences in climate or hydrology.

The bill places the burden of proof on the farmer or discharger to show that he has made maximum use of best available technology (BAT) within his economic capability. As a means of enforcement, the bill would open up the financial records of individuals to EPA and state enforcement agencies.

Other features of S. 1081 that are troubling to the agricultural community include:

- o a requirement that fertilizer sales, which are currently registered and regulated in most states, be regulated nationally;
- o an increase in permit fees that would impose an annual \$2500 fee on small feedlots and could require a similar fee of other small farmers; and
- o a requirement that the U.S. Department of Agriculture enter into mandatory contracts with rural land owners to maintain BMPs

The legislation assumes that farming practices and animal waste facilities are the greatest contributor to nonpoint source pollution, while ignoring the effect of combined sewer overflows, atmospheric deposition of pollutants, and persistent problems with violations of National Pollutant Discharge Elimination System permits by industry.

The legislation is ill conceived in that it : greatly impacts programs established under the 1990 Farm Bill and other USDA programs without a significant role for the Department, ignores good science and cause and effect relationships, calls for a non-degradation standard for waters within National Forests (virtually unachievable), and requires EPA to regulate the management of all federal lands.

Today, the Clean Water Act complements and supports state water law and water rights. S. 1081 is troubling to the West, in particular, in that it would supplant the clean water focus of existing federal law and substitute a regulatory "ecological integrity" program. Natural conditions of water bodies would become paramount. A direct assault on state water laws and water rights would occur because withdrawal of water from streams and lakes is necessary for the exercise of water rights and diversions of water from streams and lakes always changes the natural conditions of water bodies.⁷ Consequently, the Clean Water Act would become a national instream flow law.

⁷ National Water Resources Association. 1992. Testimony on S. 1081 (Submitted for the record and prepared by Gregory J. Hobbs, Jr., Attorney, Davis, Graham, and Stubbs, Denver, Colorado)

The instream flow program of a reoriented Clean Water Act would be implemented through the water quality criteria setting process (PL 92-500, Section 304) and the water quality standards program (PL 92-500, Section 303). Criteria setting under Section 304 of the Clean Water Act sets the basis for water quality standards which are enforced upon the states under Section 303 of the Act in connection with classified water uses.

S. 1081 defines "hydromodification" as a pollutant. Hydromodification is the alteration of water flows by means of water facilities such as diversions, dams and reservoirs. Restrictions against water diversion and storage would certainly be the result of Section 304 criteria under S. 1081. The water quality standards program of Section 303 of the Act would be amended by S. 1081 to implement the new "ecological integrity" purpose by means of strict antidegradation requirements. S. 1081 would, therefore, subject diversions, dams and reservoirs to water quality standards which would determine the flow required to remain or be restored in streams and lakes for the purpose of ecological integrity. An EPA document "Biological Criteria" plainly sets forth this objective which would lead to EPA regulation of water depletions. S. 1081 would also add to the Clean Water Act new interstate water management programs which could override state water law, water rights and interstate water entitlements.⁸

The National Water Resources Association has urged the Congress to reinforce Section 101(g) of the Act, which was meant to protect the state allocation systems and the exercise of water rights and to use it as a "yardstick" for the evaluation of all additions, deletions or modification to the Clean Water Act.

A FORMULA FOR SUCCESS

We believe, quite strongly, that a strict regulatory approach to the problem of managing nonpoint source pollution will not work. Furthermore, such an approach would cost a staggering amount of money, be administratively unenforceable, and cause unwarranted economic upheaval in rural communities throughout the Nation.

For several months, representatives of virtually all of the major water and agricultural associations and organizations have been working on principles upon which federal, state and local programs can be developed to adequately address nonpoint pollution from agriculture. It has been a difficult exercise bring together the diverse interests groups in order to support a common course of action. Some of the principles were based, in part, on an earlier effort by the U.S. Committee on Irrigation and Drainage as outlined in "How Can Irrigated Agriculture Exist With Toxic Waste Regulation."

Following are the principles which we hope will lead to workable amendments to the Clean Water Act that build upon the successes of the Section 319 program:

- o The Clean Water Act does not stand alone in protecting America's waters from nonpoint source pollution. Other ongoing programs at

⁸ Ibid

the federal, state and local level must be fully funded and implemented in a coordinated manner with the Clean Water Act. These include the environmental protection programs of the 1985 and 1990 Farm bills, the Safe Drinking Water Act, the Endangered Species Act, the Coastal Zone Management Act, etc.

- o Current Clean Water Act language contains potentially effective nonpoint source pollution prevention provisions embodied in Section 319. Although this nonpoint source Section has been historically underfunded and has suffered from EPA and state bureaucratic roadblocks, it is the preferable vehicle for nonpoint source pollution prevention. Changes which occur during the Clean Water Act reauthorization should reinforce existing nonpoint source pollution provisions.
- o Given the highly localized but diverse nature of nonpoint source pollution, reducing its impact on America's waters requires a different approach than control of point source pollution, such as site-specific natural resource management systems designed to protect state-identified beneficial uses of water and encourage voluntary participation through education and incentive-based programs.
- o States should continue to lead the effort to identify and resolve their priority nonpoint source water problems through administration of Section 319 funds. States should cooperate with federal agencies to harmonize objectives and coordinate funding for national and regional nonpoint source reduction programs. The goal should be to protect natural resources and designated water uses, including use by agriculture.
- o In order to optimize the positive impact of limited the Clean Water Act resources, nonpoint source management programs should be directed by states to priority areas based on problem assessments which identify water bodies with impaired or threatened uses and which represent achievable nonpoint source reduction goals.
- o Nonpoint source pollution management programs should be developed on a hydrologic unit, watershed-wide basis whenever possible.
- o In order for Section 319 to work at the state and local level, the U.S. Department of Agriculture must be an active partner in delivery of education and technical assistance to agriculture.
- o Voluntary agricultural pollution prevention practices have obtained the best results when locally designed and applied. Any regulatory actions should be implemented at the discretion of state and local authorities only after it has been clearly demonstrated with assessment data that the voluntary approach is insufficient to meet identified goals.

- o Ongoing monitoring and assessment research are critical for identifying and properly addressing nonpoint source problems. A strong financial commitment to research, monitoring and assessment projects is imperative.
- o Recognizing the long-term commitment our country has had to point source pollution reduction, success with nonpoint source reduction will require an equal commitment of time and resources.

VOLUNTARY PROGRAMS THAT WORK

Rural Clean Water Program: The Rural Clean Water Program (RCWP) is a 15 year project begun in 1980. Its objectives are threefold: (1) to improve water quality and beneficial uses in the most cost-effective manner possible, consistent with the production of food and fiber, (2) to help rural landowners and farmers practice nonpoint source pollution control, and (3) to develop and test programs, policies and procedures designed to control agricultural nonpoint source pollution.

The program is administered by the U. S. Department of Agriculture's Agricultural Stabilization and Conservation Service in cooperation with several federal, state and local agencies and RCWP coordinating committees. A total federal appropriation of \$64 million has funded 21 watershed projects in 22 states across the country.

The RCWP has proved a successful experiment upon which future programs for the control of nonpoint source pollution and improved water quality can be based. The following selected project profiles demonstrate what can be accomplished by a modestly funded but well coordinated voluntary program:

- o **Rock Creek, Idaho:** Fishing and contact recreation in Rock Creek were impaired by sediment, bacteria and other pollutants discharged into the creek from irrigation ditches. Early installation of sediment retention structures and irrigation management systems, followed by a gradual shift to conservation tillage, has resulted in measured decreases in suspended sediment levels and a steady increase in rainbow and brown trout populations.
- o **Snake Creek, Utah:** Snake Creek is a minor tributary to Deer Creek Reservoir, a heavily used recreational resource and water supply for about 500,000 people. Eutrophication and bacterial problems in the reservoir are caused only partly by nutrient and bacterial loadings from Snake Creek. Successful treatment of all eight animal operations in the 700-acre project area has reduced both average phosphorus concentration and fecal coliform levels by about 90 percent. The success of the RCWP has led to spin-off implementation in other parts of the watershed, resulting in measured water quality improvements in Deer Creek Reservoir.
- o **Long Pine Creek, Nebraska:** The trout fishery in Long Pine Creek is impaired by high sediment loadings derived from streambank erosion and irrigation discharge. Agricultural, domestic and municipal uses of the groundwater supply are impaired by high

nitrate (5-10 percent of sampled wells exceed the drinking water standard) and pesticide levels resulting from fertilizer and pesticide usage. Irrigation water management that includes tailwater recovery is being emphasized to help control the sediment problem. Fertilizer and pesticide management are being implemented through an Extension Service-sponsored producer association. The association promotes deep soil sampling to use nitrogen deep in the soil profile and pest scouting to tailor pesticide use to need.

Alliance for a Clean Rural Environment: The Alliance for a Clean Rural Environment (ACRE) is a nonprofit, non-political group which produces and distributes timely information that agricultural chemical users can follow to reduce or eliminate their impact on water supplies. These materials are easy to understand and use, yet factual and based on proven scientific research. Subjects include: safe agricultural storage, handling, mixing, and loading; protecting surface water through conservation farming methods; proper sealing of abandoned wells to protect ground water; protecting wetland waterfowl and aquatic life; and on-farm planning for water quality protection.

ACRE publishes information for farmers, ranchers, vegetation managers, commercial chemical applicators and others in agriculture who deal with crop protection chemicals. Information appears in hundreds of magazines and newsletters, as well as programs on radio and television. Workshops and agricultural dealer educational programs are also sponsored by ACRE to help foster wider understanding of agriculture's responsibility for protecting water quality. Those receiving ACRE information help protect water quality by using sound chemical handling practices in their daily activities. ACRE cooperates with many other public and private groups. Together, they form an informational network that makes a positive difference in today's agriculture.

ACRE forms alliances with farm, commodity, grower and educational organizations, rural conservation advocacy groups and related agricultural and environmental interests at the state, regional and national level. These alliances help boost ACRE's effort to produce locally appropriate materials and participate in regional projects of other groups.

What have these voluntary experiments shown us? They have shown us that: a) low-cost voluntary programs are appealing and supported by most farmers and farm communities, b) voluntary best management practices can and do improve water quality, c) federal, state and local agencies can develop cooperative programs that effectively address problems on a watershed or site-specific basis, and d) education must become an integral part of any program if it is to succeed.

Miscellaneous Federal Programs: There are several federal programs which if coordinated and funded adequately could make substantial progress in better management of pollution from nonpoint sources.

One such program is the Water Quality Incentive Projects (WQIP) program. The WQIP program provides technical assistance and incentive payments to farmers to achieve the source reduction of nonpoint source contaminants to both surface and ground water supplies. It is a program which is targeted to regions with identified

water quality problems and solutions focus on management practices. The program has shown promising results. Unfortunately, the WQIP program was only funded at \$6.75 million in FY-1992.

The Conservation Reserve Program (CRP) was authorized by the 1985 Farm Bill. Under the CRP, farmers enter into contracts to remove highly erodible land from production for a minimum of 10 years. The farmer thereby receives annual rental payments for the land removed from production and technical and financial assistance in managing the land to reduce soil erosion. The USDA estimates that the program results in an annual reduction of 61 million pounds of pesticide, 2.4 million tons of fertilizer, and 215 million tons of sediment loadings into water bodies.

These are just a few of the examples of federal and nonfederal programs which work and will provide the kind of results sought by the sponsors of S. 1081 if they are adequately funded and allowed the time to show results.

SUMMARY AND CONCLUSIONS

Agriculture has a strong record of support for programs which enhance and protect our Nation's natural environment. Understanding the need and given the proper technical and financial assistance, farmers nationwide have reacted positively to rural environmental programs.

Faced with a sizable budget deficit and a staggering national debt, it is a certainty that Congress cannot dedicate the level of funding or commitment to the management of nonpoint source pollution that it did to control of point source pollution. Therefore, it is imperative that the limited resources available be used efficiently and effectively.

Progress is being made in the management and control of nonpoint source pollution through a myriad of private, state and federal programs. These programs must have a chance to work. S. 1081 would create an inflexible bureaucratic nightmare administered by an agency of government which has no understanding of or working relationship with American agriculture.

A coordinated voluntary program that targets limited resources, builds on the success of existing agricultural pollution prevention practices, and recognizes that progress will take time and commitment, can work.

REFERENCES

- Alliance for a Clean Rural Environment. 1992. ACRE Promotional Packet. Washington, DC.
- Hobbs, Gregory J. Jr. and Raley, Bennett W. 1988. "Water Quality versus Water Quality: A Delicate Balance." Rocky Mountain Mineral Law Institute. Vol. 34. pp. 24-1 - 24-64.
- National Water Resources Association. July 1991. Testimony on S. 1081. Gregory J. Hobbs Jr. Arlington, VA.
- North Carolina State University. 1992. "Evaluation of the Experimental Rural Clean Water Program." North Carolina Cooperative Extension Service. Raleigh, North Carolina.
- Pifher, Mark T. November 1990. "Section 319 and Hydrologic Modifications: Another Assault-Part I." The Colorado Lawyer. pp. 2251-54.
- Pifher, Mark T. December 1990. "Section 319 and Hydrologic Modifications: Another Assault-Part II." The Colorado Lawyer. pp. 2445-47.
- U.S. Congress. May 15, 1991. Statement (Senator Baucus) Introducing S. 1081. Washington, DC.
- U.S. Environmental Protection Agency. 1990. "Biological Criteria." Office of Water Regulations and Standards. WH-585. Washington, DC.
- U.S. Environmental Protection Agency. 1990. "Rural Clean Water Program." Office of Water. WH-553. EPA 440/4-90-012. Washington, DC.
- U.S. Environmental Protection Agency. 1991. "Nonpoint Source Watershed Workshop." Office of Research and Development, Office of Water. EPA/625/4-91/027. Washington, DC.
- U.S. Environmental Protection Agency. 1992. "Managing Nonpoint Source Pollution." Office of Water. WH-553. Washington, DC.

HOW PROBIOTIC FERTILIZERS IMPROVE IRRIGATION EFFICIENCY, BUFFER SALTS, AND REDUCE NITRATE INFILTRATION INTO GROUNDWATER

Kenneth R. Martin

Robert Ellsworth, Ph.D.

ABSTRACT

Since the advent of chemical fertilizers there has been a loss of humus in most agricultural soils and a diminishing of the vital biological dynamics which were present in less intensive chemical farming. The loss of healthy top soil is well documented. Salt problems are significant in virtually all irrigation areas, and the deterioration of soil structure with resulting reduction of irrigation efficiency is well-known.

Probiotic technology, which takes into account the biological potential of soils, can reverse these trends and enables the farmer to use "environmentally friendly" fertilizers which restore and build healthy soil by increasing the humus complexes in soils. The dramatic change in soil structure improves water infiltration and water release efficiency, and buffers harmful salts in water and soil.

University research has shown that nitrate fertilizers can be maintained in the root zone with less leaching of nitrate and other agrichemicals due to biological complexing and chelation. Probiotic technology enhances the natural processes in the soil while biodegrading the detrimental chemical residue that has accumulated in soil.

Humus is a biological soil derivative which has received insufficient research attention. The pressure to develop high production agriculture utilizing salt-based fertilizers and a host of chemicals has been the focus of most agricultural research. The residual of many of these compounds has been detrimental to the health and vitality of the natural biological systems. Soil conditions have generally deteriorated. This deterioration contributes to erosion which is responsible for significant losses in fertile soil every year.

EFFECT OF MICROBES ON SOIL STRUCTURE AND FERTILITY

There seems to be a limited amount of information on soil biological dynamics and how these dynamics affect irrigation efficiency, soil fertility, crop response, and farm profits which is available to the grower.

Soil scientist F. Lyle Wynd¹ (1963) has wisely stated, "The plant eats at the second table—the plant gets what the microbes give it!" The research literature confirms that the microbe is the superior competitor over the plant for nutrients in a nutrient-deficient environment.

To a great degree, plants are dependent upon microbes for balanced nutrition. Microbes need the same essential nutrients as plants. If the biological environment is not restricted by harsh chemicals or other detrimental practices, microbes are able to feed on nutrients needed for their metabolism.

Several nutrients including phosphate and potassium are usually chemically bound soon after application as fertilizer and are subsequently unavailable for immediate plant nutrition. As the biological community utilizes nutrients needed for microbial support, they are converted to nutrients which are ultimately available to the plants.

THE IMPORTANCE OF AEROBIC MICROBIAL FUNCTIONS

Wilson,² (1992) reports that most of the characteristics that we normally associate with a productive soil are either directly or indirectly associated with aerobic biological activity. Microbial activity determines the tilth of a soil through flocculation, aeration, and humus formation. A healthy soil is very much a living entity that is teeming with a wide variety of micro-organisms. However, many of our agricultural soils are not biologically healthy. Modern intensive farming often requires extensive use of agrichemicals and salt-based fertilizers. Large scale farming, which use heavy machinery to maintain timely planting and harvest schedules, often creates significant soil compaction. Compaction becomes a serious factor, reducing water infiltration and moisture retention. In addition compaction restricts free movement of water and salts downward, resulting in salt accumulation in the root zone of the soil.

Wilson further states that significant improvement in soil flocculation by the action of agricultural probiotics serves an important function in many agricultural soils. High alkalinity and salinity pose a serious problem in many coastal and arid areas. Sodium salts are especially damaging to both crop yield and soil structure. Probiotic fertilizers buffer salts by dissociation and organic chelation and immobilization of the component elements. Dissociated salts are far less damaging to crops and soil and remain dispersed in the soil profile rather than concentrating at the upper levels of the root zone. Multiple applications of probiotic fertilizers during the growing season is most effective in salt management.

Probiotic technology which takes into account the biological potential of soils can reverse detrimental trends in soils and establish an "environmentally friendly" agrichemical relationship which restores and builds healthy soil by increasing the humus complexes in soils. Growers using probiotics report a dramatic change in soil structure which improves water infiltration and water release efficiency while buffering harmful salts in water and soil.

PROBIOTIC FERTILIZERS

Probiotic fertilizers are composed of natural biological systems, buffers, organic acids, nutrients, and energy systems which are formulated to balance the soil and enhance the indigenous microbial soil population which is usually at low levels in modern agriculture. Probiotic fertilizers are formulated by complexing plant nutrients with probiotic compounds forming more environmentally friendly fertilizers.

Probiotics help bio-degrade chemicals and other substances that are detrimental to biological activity and add energy and nutrients needed for optimal microbial activity. The complete degradation of these harmful substances yield carbon dioxide, water, and humus. When enhanced with probiotics this microbial reservoir becomes a vital source of available nutrients for plant life.

As the humus fraction develops it provides an organic reservoir of complexed nitrogen and other nutrients which are organically stabilized. This reduces the nitrogen solubility, enabling the soil to retain this nitrogen which would otherwise leach past the plant root zone and become a potential groundwater contaminant.

As organic residues and probiotic fertilizers are added to soil, the microbes utilize the fertilizer to provide the energy to convert organic matter to humus developing a rich organic bank of nutrients which crops can access when needed.

The balance of this paper consists of University research and field trials which demonstrate the effect of probiotic fertilizers on water infiltration, irrigation efficiency, nitrogen fertilizer efficiency, reduction of nitrogen leaching, and buffering of salts in soil.

EFFECT OF PROBIOTIC FERTILIZER ON WATER INFILTRATION

These field trials were conducted by Waldon Laboratories of Ripon, California in 1987.

Objective

To determine infiltration rate changes in a low organic and low cation exchange capacity soil following the application of "Lase", a probiotic fertilizer, which enhances humus formation and soil flocculation.

Materials and Methods

The test soil was Ripon sandy loam, (1% organic matter, with a Cation Exchange Capacity of 14). This soil has no noticeable water penetration problems.

Twenty-five furrows, 12 inches wide and 4 inches deep, were laid out on 30 inch centers 30 feet long. Irrigation tubing was placed along the end of the furrow with one 3 inch gate at each furrow. Water was supplied by a 500 gallon tank, gravity fed.

The soil was allowed to air dry to 12 inches then the water was applied to one furrow at a time to a depth of 3 inches until all 500 gallons were used. The total number of feet of furrow watered were measured.

The soil was allowed to air dry again and the Lase was applied to the test areas and all furrows were watered to allow normal penetration and action.

The soil was allowed to air dry again then 500 gallons of water was applied as in the first irrigation. The total number of feet of furrow was again measured.

The rate and time of flow was constant for each irrigation based on constant gate openings and water head.

Results

The final irrigation, untreated control, covered 390 feet with 500 gallons. The final irrigation, Lase treated, covered 240 feet with 500 gallons of water. This represents an infiltration rate increase of 38% (390 feet minus 240 feet divided by 390 feet), expressed as water absorbed per foot of row. The control absorbed 1.28 gallon/foot of row while the Lase treated absorbed 2.08 gallons/foot of row for a 62.5% increase.

Conclusions

The single Lase application produced a substantial increase in water infiltration rate in this soil. Experience has shown that as probiotics improve water infiltration, they also improve water retention and release to the plants. This results in improved irrigation efficiency.

PROBIOTIC EFFECT IN IRRIGATION WATER REDUCTION

Using probiotics to develop a humus-rich soil provides improved water efficiency. The following chart shows the improved efficiency reported by the Visalia Country Club in Visalia, California.

When given the challenge to reduce water consumption, West³ investigated methods to accomplish water reduction while maintaining excellent playing

conditions. In 1990, it was necessary to water the turf 7 days per week for 15 minutes twice daily to keep the grass from water stress. Even then puddles of water formed on the course and water runoff occurred.

West was introduced to Huma Gro probiotic fertilizers in November of 1990. He applied the probiotic "Thatch" to improve water penetration and absorption. By spring of 1991 the soil "black layer" was dissipating, plant root depth and mass had increased from 3" to over 12", and the water was penetrating the soil profile.

Fig. 1

Water Use Comparison 1990 vs 1991

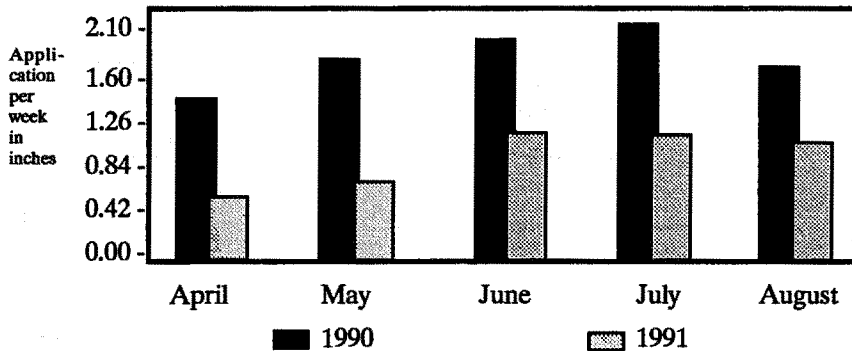

Fig. 2

	Weekly Water Application		Inches of Water Reduction for the month
	1990	1991	
April	1.35	.50	3.4
May	1.74	.75	4.95
June	2.03	1.00	4.12
July	2.10	1.06	4.16
August	1.87	1.00 (1st week's data)	4.00 (est)
Total reduction Y.T.D.			20.63 inches

Due to the increased water infiltration, the irrigation pattern in 1991 was changed to 3 days per week resulting in a significant reduction in water applied, greater root depth and mass, and little or no puddling of water and/or runoff. This resulted in a turf with excellent playing conditions and easier maintenance. Water savings with less stress to the turf resulted from the use of Huma Gro probiotic fertilizers.

PROBIOTIC FERTILIZERS ALLOW REDUCED WATER AND NITROGEN REQUIREMENTS

A field trial conducted by Culver and Ellsworth⁴ demonstrated the effect of probiotic fertilizers on water and nitrogen usage.

Water / Nitrogen Usage Study

Location: Lemoore area, Kings County, California.
Crop: Wheat

History of both plots were similar with previous crops of silage corn. Soil preparation, pre-irrigation, and planting were also similar.

Fig. 3

Fertilizer	Nitrogen Applied (lb/acre)	Cost of Fertility (\$/acre)	Water applied following pre-irrigation	Water Cost	Yield of silage (Tons/Acre)	Crop value ^{1/} (\$/acre)	Net Return above Fertilizer Price (\$/acre)
Huma Gro	54	41.50	0.5 Acre Ft.	10.00	11.59	231.80	180.30
Conventional	170	44.20	1.5 Acre Ft.	30.00	7.66	153.20	79.00

1/ Based on a value of \$20/ton for winter forage.

The fertilizer, irrigation input, crop yield, and net return per acre for the two fields are shown in Fig. 3. Fifty-four units of nitrogen were applied in the Huma Gro probiotic fertilizer field, compared to 170 units of nitrogen in the conventional fertilizer program field. One post-plant irrigation was necessary in the Huma Gro field, compared to three in the conventional field.

The net return over fertilizing cost was \$180.30 per acre in the Huma Gro field, compared to \$79.00 per acre in the conventional field resulting in an increase of \$101.30 for the Huma Gro field. The water savings of one irrigation in the Huma Gro field (\$10.00) compared to three in the conventional field (\$30.00) was an additional economic advantage, as well as irrigation labor savings.

Improved water absorption and release to the crop contributed to improved irrigation efficiency in the Huma Gro field. As a result of the positive changes in the soil structure that occurred in the Huma Gro field, post-harvest ripping of the soil was not necessary in preparation for planting the following crop of silage corn. Ripping was necessary under the conventional fertilizer program.

The Huma Gro probiotic fertilizer provided the following advantages:

- a) Increased yield
- b) Comparable fertility costs with reduced nitrogen application
- c) Reduction in irrigation costs
- d) Reduction in tillage costs.

NITROGEN EFFICIENCY AND LEACHING FIELD TRIALS

In Othello, Washington in the Columbia Basin Region, field trials of growing potatoes were conducted including one at Washington State University research station near Othello and in a commercial grower's field, comparing Huma Gro probiotic fertilizers and conventional fertilizers.

Washington State University Potato Trials

During the 1989 planting season near Othello, Washington, the Huma Gro company authorized and supported a field trial of its probiotic fertilizers on the production of *Solanum tuberosum* "Hilite" potatoes. One function of the testing procedure was to check the level of post-harvest residual soil nitrate. Hiller and Ellsworth⁵ reported the design and results of the test.

For the function in question, the test-plots were replicated three times on a fine sandy loam soil. The Huma Gro probiotic fertilizer program was compared to a conventional fertilization program. One test plot was treated with the Huma Gro probiotic fertilizers the prior fall season.

"Hilite" potato seed was planted on all test plots and grown for the entire season. Tillage practices on all plots were identical. One plot fertilized conventionally received 312 lbs per acre of nitrogen fertilizer while the other plot had 193.5 lbs of Huma Gro complexed nitrogen.

Tests were made both during and after the growing season for residual soil nitrate levels. Soil samples were taken at harvest from both treatments and tested for NO₃ levels. Test results are shown in Fig. 4.

Fig. 4

Nitrate Analysis of Soil Following Harvest

Depth	HUMA GRO plots lbs NO ₃ per acre	Conventional plots lbs NO ₃ per acre	% Difference
Top Ft.	79	66	19.7
2nd Ft.	52	84	(38.1)
3rd Ft.	39	78	(50.0)

Figure 5 was derived using the data from Fig. 4. It should be noted that Huma Gro nitrates remained closer to the soil surface than the conventional fertilizer. With the conventional fertilizer, nitrates remaining after the growing season were spread throughout the soil profile. Huma Gro nitrates on the other hand, remained primarily in the top of the soil profile. The concentration of Huma Gro nitrates decreased as the depth of soil increased.

Fig. 5

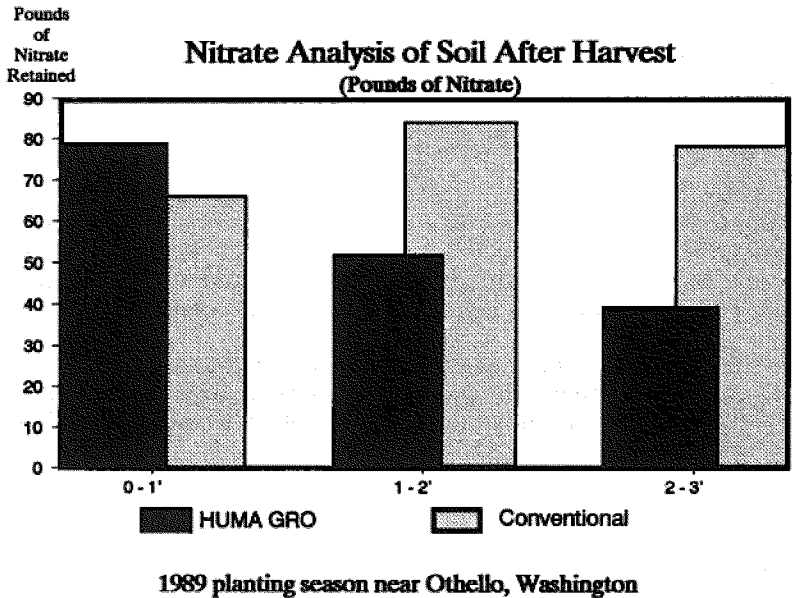

Soil Nitrates Comparison Washington Field Trial

Soil samples were obtained and analyzed for residual NO_3 from two adjoining fields following potato harvest near Othello, Washington in 1989. Samples were taken to represent the first foot, the second foot, etc., down to the fifth foot. Results are shown in Fig. 6. As in the WSU plots the residual levels of NO_3 in the soil from the Huma Gro fertilizer were higher at the 0 to 3' level and lower at the 4' and 5' level than the conventional fertilizer plots. The nitrates from the conventional fertilizer plots appear to be moving deep into the soil profile raising some serious questions about potential ground water contamination.

fig. 6

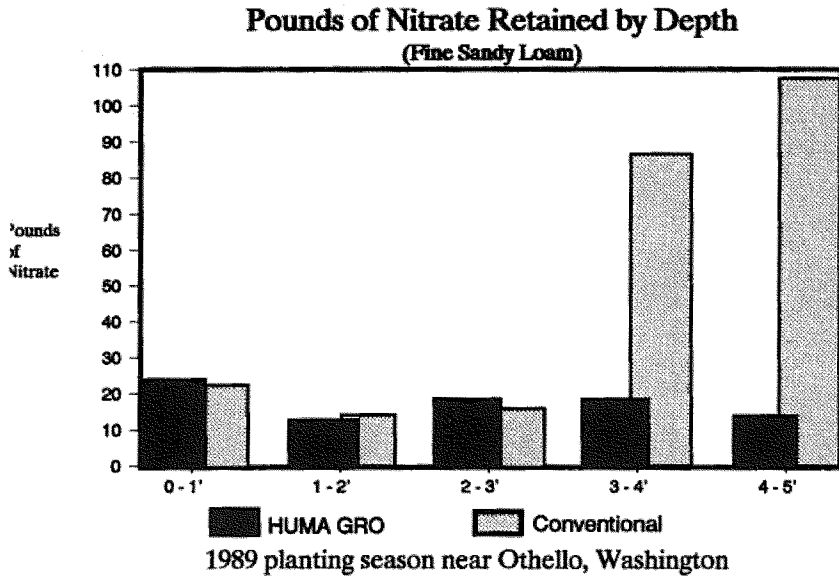

Conclusions

In this test, Huma Gro nitrates remained within the root zone to a greater extent than did those from conventional fertilizer practices. The conventional plots nitrate levels at the 3-4' and 4-5' depths indicate greater nitrate leaching than the Huma Gro plots.

SLOWING NITRATE LEACHING IN FARM SOILS

Ellsworth,⁶ conducted field demonstrations showing the effectiveness of Huma Gro probiotic fertilizer in reducing nitrate leaching in farm soils near Fresno, California. The following is a description of the field trial with resulting graphs showing how probiotics kept the nitrogen in the root zone, reducing the opportunity for nitrogen to be leached into the groundwater.

A field trial comparison analysis between two equal soil conditions was conducted near Fresno, California in 1991 to evaluate nitrate stability in the top three feet of soil.

Procedure

Twenty-five gallons of Calcium Ammonium Nitrate was applied to one plot in a plum grove. A similar quantity (25 gallons per acre) of the same product with the addition of Huma Gro probiotics "Octavol" (8 oz/20 gallons) and "Octagen" (64 oz/20 gallons) was applied to an adjacent plot at the same time. These probiotic products complex nitrogen for improved availability with less nitrogen loss from the root zone. Following two irrigations, soil samples were taken from 0-1', 1'-2' and 2'-3' depths in both areas.

Fig. 7

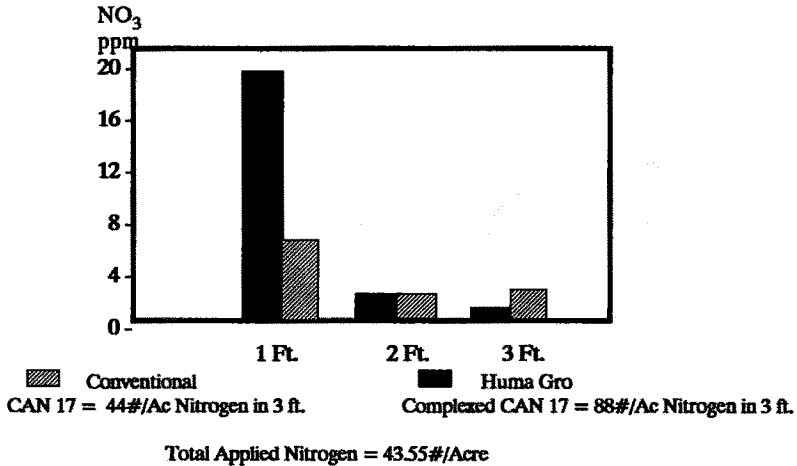

Results & Discussion

The results shown in Fig. 7 demonstrate the feasibility of holding applied nitrogen in the plant root zone. The complexed CAN 17 (Huma Gro) plot contained 3 times more nitrogen in the top foot of soil (the primary root feeding area) than the non-complexed CAN 17 plot. The total nitrate nitrogen in the three foot range shows nearly a 2 to 1 (84-44) advantage for the complexed plot. The short term economic advantages are immediately apparent. The long term decrease in nitrogen leaching can significantly reduce aquifer contamination.

Huma Gro probiotic fertilizers preserve the nitrogen availability while protecting the environment.

PROBIOTICS BUFFER SALTS IN SOIL

Ralston⁷ of Triple R Farms of Maricopa, Arizona has been using Huma Gro probiotic fertilizer since 1979. Soil samples were analyzed from four fields in February 1979 prior to using probiotic fertilizers. These same fields were analyzed in October 1985 after 7 growing seasons utilizing probiotic fertilizers, showing a significant reduction of soil pH without the use of gypsum or other products generally used to alter soil pH. The following graph shows the pH before and after 7 growing seasons of probiotic soil treatment.

Fig. 8

Soil pH Analysis on Four Fields
Triple R Farms, Maricopa, Arizona

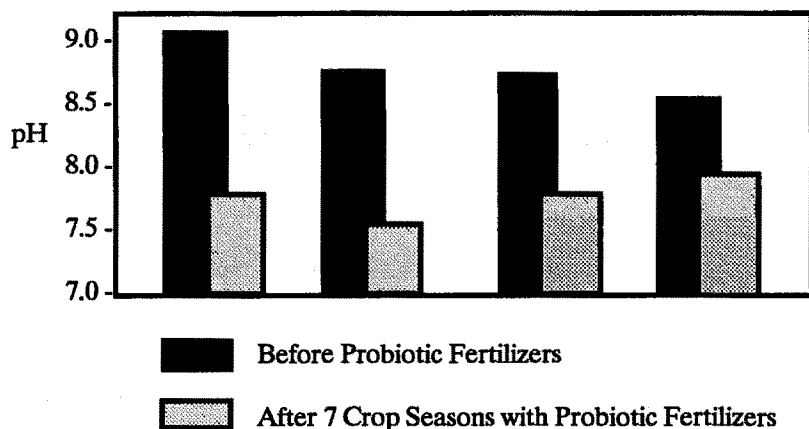

The surrounding desert soil is very low in organic matter. Most farms in this region have soils which analyze .5% to .8 % organic matter.

During this same period noted in Fig. 8 the organic matter analysis increased from an average of .5% organic matter in 1979 to an average of 2.3% organic matter in 1985 after 7 cropping seasons. This increase in organic matter occurred in a crop program of cotton without rotation. The probiotic fertilizers provide biological activity for decomposition of cotton stalks and roots forming humus which provides a buffering of salts and reduction of pH.

SUMMARY

The far-reaching effects of replacing conventional fertilizer with probiotic fertilizers offers encouragement that many of the soil and water problems in irrigated agriculture can be reversed.

Harnessing the natural power of the soil microbes by utilizing probiotic technology as prescribed by Huma Gro is now a practical reality. Growers utilizing probiotic fertilizers report significant improvement in soil and farming conditions as follows:

- * Improved structure and tilth of soil
- * Increased levels of humus in the soil
- * Reduced disease and pathogen incidence
- * Bio-degradation of toxic residual chemicals including previous applied pesticides
- * Reduced amounts of fertilizer and chemicals to grow crops establishing an effective Low Input Sustainable Agriculture (LISA) alternative
- * Reduced nitrogen leaching out of the crop root zone
- * Improved water infiltration, retention and release to the crop which improves irrigation efficiency
- * Reduced tillage costs
- * Buffering of damaging salts in the soil and water, reducing the effects of salinity and alkalinity

There is a possibility of treating irrigation water at the water district level to improve soils for improved water efficiency. Probiotics encompasses technology utilizing both organic and inorganic chemistry. Probiotics softens the impact of agrichemicals on soil while enhancing the biological potential in the soil. Soil biochemistry and microbiology offer a great hope for further improvements in the field of probiotic fertilizers.

REFERENCES

- 1/ Wynd, F. Lyle, 1963, *The Living Soil*.
- 2/ Wilson, Norman, 1992, *Huma Gro Blend in The Growing Edge*, Vol. 3, March . 2 - 4.
- 3/ West, Rick, 1990, Visalia, California Country Club, *Water Efficiency Evaluation With Probiotic Fertilizers*
- 4/ Culver, Dennis, 1990, Ellsworth, Robert , Ph.D., *Effects of Probiotic Fertilizers on Water & Nitrogen Efficiency*
- 5/ Hiller, Larry, 1991, Ellsworth, Robert, Ph.D., *Potato Field Trials with Probiotic Fertilizers*
- 6/ Ellsworth, Robert, 1991, *Effects of Probiotic Fertilizers on Nitrate Leaching*.
- 7/ Ralston, Bob, 1986, *Probiotics Buffering of Salts in Soil*.

HYDROELECTRIC PROJECT LICENSING:

POSSIBLE LESSONS FOR AGRICULTURAL WATER USERS

Richard A. Westmore¹

ABSTRACT

Most U.S. Hydroelectric projects are subject to the relicensing requirements of the Federal Energy Regulatory Commission (FERC). Over 150 operating projects have licenses which expire on December 31, 1993. Applications for relicensing of these projects were required to be submitted to the FERC by December 31, 1991. The Federal licensing process stipulates that project owners must consult with natural resource agencies and the public to identify the impacts of project operations on the natural environment and possible measures to enhance environmental values by modifying project operation.

Experience gained during the recent hydroelectric project relicensing activity may be extremely valuable to the community of agricultural water users. Presently, the Federal government does not regulate diversions of surface water for irrigated agriculture, nor is a formal agency consultation process required. Generally, diversions for agricultural use only are "regulated" by established water rights and any other State-imposed requirements to maintain flows in the stream below a point of water diversion. When irrigation diversion dams require major repairs or replacements, projects fall under the review of the Department of the Army Section 404 permitting process. At this time, operational impacts may need to be addressed in order to obtain needed permits.

Over the past two decades, the number of Federal regulations designed to protect water quality and environmental values have grown dramatically. These regulations are strict, enforceable, and backed by national environmental groups and the public in general. Given the present regulatory climate, it seems likely that requirements for agency consultation and impact evaluation may eventually be applied to operating projects involving diversions of water for irrigated agriculture.

Recent experiences in FERC licensing, and hydroelectric development and operation, provide some valuable insights into what irrigation interests may expect in the future, as battles intensify over water for developmental needs

¹Project Manager, Senior Water Resources Engineer, GEI Consultants, Inc., Denver, Colorado

versus maintaining environmental values. Hydroelectric project relicensing experience suggests that even small irrigation project operations could be impacted if government gains increased abilities to regulate the operation of irrigation projects. Such regulation could be an outgrowth of the Clean Water Act reauthorization, which will be further considered by Congress in 1993.

INTRODUCTION

In December 1991, the Federal Energy Regulatory Commission (FERC) received over 150 applications for licenses to operate existing hydroelectric projects. These submittals to FERC were part of relicensing efforts conducted by hydroelectric project owners throughout the U.S. for projects having current licenses under the Federal Power Act that will expire on December 31, 1993. Relicensing activities for all of these projects, as well as all new hydroelectric projects and expansions of existing facilities, are being conducted under the regulations of the Electric Consumers Protection Act (ECPA) of 1986. ECPA requires a formal consultation process to involve the concerned natural resource agencies and the public in identifying and resolving issues relating to project construction, operation, and maintenance, as they relate to the project's effects on the natural environment. During hydroelectric project relicensing, issues relating to project operations have been the most sensitive and confrontational.

Most of the "Class of '93" hydroelectric projects have been operated in the same manner for at least 30 years, when licenses were issued, and many have operated for over 80 years. These projects have become part of the "environments" in which they exist, and owners have been very reluctant to consider changing the operations of these projects to meet the environmental and land management objectives of State and Federal natural resource agencies. For their parts, the resource agencies contend that the hydroelectric project owners have benefited from the present operation practices for at least several decades and that "pay-back" time is at hand.

The FERC is charged with attempting to balance the so-called "developmental values", associated with continued project operations to maximize energy production, against the "environmental values", associated with modifying project operations to reduce environmental impacts and/or provide environmental enhancements. A wide variety of resource agencies have been involved with relicensing activities.

<u>State</u>	<u>Local</u>	<u>Federal</u>
• Natural Resources (Fish and Wildlife)	• Towns and Cities	• U.S. Fish and Wildlife Service
• Health	• Counties	• Forest Service
• Water Quality	• Special Districts	• Bureau of Land Management
• Historic Preservation		• EPA
• Parks/Recreation		• Corps of Engineers

Each agency has its own particular areas of concern, interests, expertise, and legal standing.

Many hydroelectric projects, particularly those in the 1 to 50 megawatt (MW) capacity range, involve diversions of water from a stream into canals or penstocks which bypass a portion of the natural stream channel. These diversions may alter streamflows in several miles of stream channel, while a portion of the natural flow is used to generate electricity. The amount of water diverted and the associated impacts on the natural flow regime are similar to diversions of water for irrigated agriculture.

In fact, agricultural water diversion may have more significant impacts than those for hydroelectric power. Diversions for irrigated agriculture usually affect more miles of channel before return flows re-enter the stream; water is consumptively used; and the quality of water returned to the stream can be degraded due to increased organic and chemical constituents. On the positive side, irrigation diversions usually do not occur year-round in most areas of the U.S., whereas diversions for hydroelectric generation normally involve year-round operations. In the Western U.S., diversions for irrigated agriculture are subject to water rights allocations, which tend to provide for maintenance of flows between diversion points to satisfy intervening water rights priorities. Nonetheless, diversions of water for irrigation supplies have the same types of environmental impacts as those diversions which are used to generate hydroelectric power.

KEY ENVIRONMENTAL ISSUES

A complete assessment of key issues emerging from the relicensing submittals of December 1991 has yet to be compiled by the FERC or others.

However, the key environmental issues in relicensing of hydroelectric projects across the U.S. appear to be:

- Impacts of hydroelectric operations on aquatic resources, including aquatic habitat, fisheries, water quality, and the stream channel itself.
- Recreational resource impacts.
- Threatened and Endangered (T&E) Species impacts.
- Impacts on visual resources and aesthetics.

Of the impacts listed above, aquatic and recreational impacts associated with diversions and flow alterations appear to be the most significant and difficult to resolve. Alterations of streamflows directly affect the quantity of aquatic habitat, stream fisheries, recreational use of the stream (for fishing, boating and rafting), and usually are perceived by the resource agencies and the public to affect visual and aesthetic resources in a negative way. The FERC licensing experience for both new and existing projects clearly demonstrates that the resource agencies, with a large measure of public support, want to see streams with flow regimes more closely matching natural conditions.

Hydroelectric power plants normally are sized to generate power during the low-flow season, which in the Western U.S. typically occurs during the winter months. At small "run-of-river" hydro plants, energy is produced throughout the winter months with turbines set at or near minimum operating levels. During spring snowmelt, the turbines operate at maximum output; however, spillage usually occurs at the hydro plant diversion dams. For most of the year, many of these small hydroelectric plants utilize virtually all of the available streamflows to produce energy. This type of operation is in many ways, typical of irrigation diversion operations, except during winter months when many irrigation systems are not operated. Also, irrigation diversions often withdraw a larger portion of the peak streamflow, particularly if diverted water can be conveyed to off-channel storage reservoirs for use later in the irrigation season.

Aquatic Resource Impacts

Aquatic Habitat: Hydroelectric and irrigation water diversions reduce streamflows and usually reduce the amount of habitat available to support aquatic life. A variety of study methods are available to evaluate the effects of flow reductions on aquatic habitats. The most popular and accepted method is called IFIM (Instream Flow Incremental Methodology). A variety of physical and biological parameters are used to simulate the relationship between streamflow and aquatic habitat over the range of streamflows for a

"typical" year or an entire hydrologic simulation period. Results of IFIM are expressed in terms of Weighted Usable Area (WUA) of aquatic habitat. The difference in the amount of WUA with and without operation of the project is a measure of the aquatic impacts attributable to the project's alteration of natural streamflows.

For a small (1.4 MW) hydroelectric project in Colorado, which diverts nearly all streamflows during the September through May period, the difference in WUA attributable to project operations was found to be only 10 to 20% of the "without project" condition. Further studies indicated that WUA could be restored to 40% of the "without project" condition, but only if hydroelectric generation would be reduced by 25%. Full restoration of aquatic habitat based on IFIM was found to reduce generation by 50%. Resource agency goals for aquatic resource management seek to maintain a self-sustaining aquatic ecosystem (U.S. Fish and Wildlife) or to maintain 40% of theoretical maximum habitat (U.S. Forest Service). These requirements could involve significant reduction in the amounts of water diverted for hydroelectric energy production and, similarly, the amounts of water diverted for agricultural use.

Fisheries: Reductions in aquatic habitat directly affect the quality of stream fisheries. Water diversions typically reduce the number and size of fish, which in turn affects terrestrial species dependent on fish as a source of food, as well as the recreational use of the stream for fishing.

At the previously mentioned small hydroelectric project in Colorado, the resource agencies (Colorado Division of Wildlife, U.S. Fish and Wildlife, and U.S. Forest Service) stated that one of their joint management goals was to restore a "self-sustaining wild trout fishery" in the 4 miles of streams affected by diversions for hydroelectric energy production. This goal would require the project owner to significantly curtail energy production. The project lands include three reservoirs formed by the diversion dams. All three contain fish, are heavily utilized for recreation, and are stocked periodically by the State. While acknowledging the recreational benefits of these small reservoirs, the Federal agencies have not been willing to consider that the fisheries in the reservoirs provide any sort of replacement or mitigation of the stream fishery impacts caused by project operations.

Water Quality: Hydroelectric projects can have significant water quality impacts, particularly in terms of dissolved oxygen and water temperature. However, these impacts typically are greatest in the tailwaters of hydropower dams and are less significant at "diversion-type" hydroelectric projects. This occurs because of water quality changes that occur in larger reservoirs. Small hydroelectric and irrigation diversion dams do not cause

significant alterations of water quality, except in terms of downstream flow changes which can impact quality due to reduction in the natural assimilative capacity of the stream.

A key issue that very likely will be faced by irrigators in coming years is the degradation of water quality due to irrigation return flows. Reauthorization of the Clean Water Act is pending in Congress. As currently written, the U.S. EPA, in cooperation with the States, will be regulating stream water quality using biological parameters in addition to the traditional chemical parameters. Non-point pollution sources may include "hydromodification" created by dams and hydropower facilities. Further, the draft water quality legislation would grant States the authority to regulate and protect water use in addition to water quality. This is a significant departure from the present water quality laws which regulate actual discharges to navigable waterways. Changes in water quality that affect biological indicators, while still meeting chemical standards, probably will be subject to regulation under the new Clean Water Act.

Stream Channel Maintenance: Natural resource agencies are becoming increasingly concerned about the effects of diversions on the integrity of natural stream channels. This concern is manifested primarily by the U.S. Forest Service, which usually raises concerns about channel degradation on stream segments in its jurisdiction. Alterations of the natural flow hydrographs are believed to create reductions in channel conveyance capacity and allow encroachment of vegetation and aggregation of channel beds, which affects aquatic productivity. The problem does not appear to be significant if Spring "flushing flows" of 200% of the mean annual flow (MAF) occur each year. These types of flows usually occur at small hydroelectric plants because they are designed to operate at peak capacity with flows much less than 200% of the MAF. Agricultural diversions typically are designed to divert larger amounts of flow and, therefore, may be subject to greater security from the standpoint of their impacts on channel maintenance.

Recreational Resources

Key issues related to recreation at hydroelectric projects involve boating (both stream-based and flatwater), fishing, picnicking, hiking, and camping, as well as other recreational pursuits. The FERC requires that project owners provide recreational amenities at operating hydroelectric projects as a condition for obtaining a license. Periodic recreation inspection of hydroelectric projects are made by FERC staff in order to check on compliance. In the past, provision of access, picnic areas, and campgrounds was adequate. Today, hydroelectric project owners have much more difficult compliance requirements.

Higher flows often need to be provided in order to maintain the usability of streams for whitewater rafting, kayaking, and canoeing. The owner must weigh competing demands for the same resource, while maintaining the viability of his operations. For example, flows that may be optimal for canoeing may be less than desirable for fishing. The amount of aquatic habitat in terms of weighted usable area may peak at a specific flow rate that is too low to maintain "optimal" conditions for canoeing or rafting. Additional releases of water to satisfy boating interests may cause reductions in aquatic habitat and diminish the quality of fishing.

Threatened and Endangered (T&E) Species

T&E species always are considered in Federal evaluation of hydroelectric projects for licensing or relicensing. In Nebraska, protection of T&E species along the Platte River (whooping crane and piping plover) has, in part, dictated how hydroelectric and irrigation projects may be operated. In Colorado, attempts are being made to recover endangered fish species (Colorado squawfish, razor-back sucker, and humped-back chub). Recovery apparently may require significant changes to the operation of hydroelectric projects, as well as irrigation and municipal water storage and diversion projects. Generally, aquatic T&E issues will require that streamflows be maintained at higher levels during key life stages of the endangered species.

Visual Resources and Aesthetics

The public is becoming increasingly sensitive to the visual and aesthetic impacts associated with diversions of water for a variety of man's uses, including hydropower, municipal water supply, and irrigated agriculture. This sensitivity is expected to translate into increased demand to see "water in the stream". In Boulder and Fort Collins, Colorado, as well as other communities, urban stream beautification programs have been carried out or are planned. In addition to various visual improvements, habitat restoration, and recreational access, these programs also involve maintenance of minimum flow levels. Both Boulder and Fort Collins have obtained water rights to maintain instream flows at minimum levels needed for aesthetic and visual reasons. The State of Colorado has an active program for acquiring water rights to maintain instream flows.

Wetlands

Protection of wetlands and maintenance of riparian habitat are defined national goals. Relicensing of hydro projects has provided agencies with the opportunity to request mitigation for past wetland impacts. Technologies associated with man-made wetlands are improving dramatically; therefore,

creation of wetlands is expected to be part of mitigation and enhancement requirements for water diversion projects.

EFFECTS OF INCREASED REGULATIONS ON IRRIGATION DIVERSIONS

Diversions of water for hydroelectric energy production are regulated through the FERC licensing process. FERC licensing rules require that project owners consult with the natural resource agencies and the public during the licensing process, as well as when projects are being considered for relicensing. This formal consultation process involves thorough identification of issues and quantification of resource impacts through field and office studies agreed upon by the project owner and the agencies. As indicated in the preceding paragraphs, key environmental issues usually can be anticipated in advance based on prior experience with similar projects and knowledge of local environment in which the project is operated.

Under ECPA, the FERC is charged with "balancing" developmental issues (energy production, dependable capacity, revenues, renewable vs. non-renewable energy, etc.) with non-developmental issues (instream flows, fisheries, recreation, T&E species, aquatic habitat, etc.). This balancing process involves the project's owner, the natural resource agencies that have standing with respect to the project's operations, and the FERC staff. Balancing does not involve a dollar-for-dollar comparison because environmental values usually are not amenable to monetary quantification. As an example, the "value" of instream flow to maintain aquatic habitat can be measured in terms of weighted usable area (WUA). Increasing the amount of WUA by changing the operation of a hydroelectric project will result in more flow bypassing the project's turbine(s) and reduced energy output. A comparison of the incremental gain in WUA with the corresponding reduction in energy production gives an indication of the "bang-for-the-buck" associated with providing more instream flow.

Conceivably, the impacts of agricultural water diversions on aquatic habitat could be evaluated in the same way. A regulation to protect or enhance the aquatic ecosystem, if imposed under the reauthorized CWA for example, could involve estimation of the amount of required instream flow below the point of diversion, which could be estimated using IFIM methods. The result could be a reduction in the ability to divert water for agricultural use in order to maintain WUA at a desired level.

FERC licensing is accomplished in a formal three-stage process requiring significant commitments of time and financial resources. Licensing costs

are borne by the project owner. The average cost to relicense each of the 157 projects with licenses expiring in 1993 will be about \$1 million. Two small projects in Colorado each having diversion capacities less than 50 cfs required in excess of \$250,000 per project for relicensing.

The three-stage process includes:

- Stage I Consultation with the resource agencies to identify environmental concerns and to scope studies to identify the magnitude of environmental effects attributable to hydroproject operation.
- Stage II Consultation involves undertaking scientific studies to quantify environmental effects. Typical studies include IFIM modeling, fish population sampling, recreational use surveys, etc. As potential adverse effects on the environment are identified, FERC expects the hydro plant owner to begin working with the agencies to identify operational changes that will enhance the local environment. A final application for license completes Stage II.
- Stage III Consultation involves FERC review of the license application, preparation of an environmental assessment to comply with National Environmental Policy Act (NEPA) requirements, negotiations with the resource agencies, and completion of the "balancing" of developmental and environmental values.

Overall, the process can take up to three full years to complete.

A similar consultation process could be required for agricultural water diversions, involving intensive interaction with regulatory agencies and the public, time-consuming and expensive studies, and difficult compliance activities. Fortunately for irrigators, no federal agency currently has "FERC-like" authority to regulate agricultural water diversions. Could such an agency come into being? Perhaps, but the more likely scenario is that movement to a biological approach for managing stream water quality may empower existing regulatory agencies to require more complete assessments of impacts associated with all types of stream diversions and flow alterations. This could be required in order to obtain a Section 401 water quality certification when diversion structures are rehabilitated or to obtain an NPDES permit if the reauthorized Clean Water Act enables regulation of dams as point sources of water pollution. It seems clear that regulations will be moving toward biological, as well as chemical indicators of overall stream health. If so, the amount and quality of aquatic and riparian habitat, as well as water quality, will be of concern to the regulatory agencies.

At the risk of sounding alarmist, a picture can be painted of increasing regulation of agricultural diversions brought on by increasing concern over aquatic habitat impacts and related environmental effects. Agricultural diversions seem likely to be targeted because, at least in the Western U.S., 80-90% of the water diverted from streams is used for agriculture and public perceptions are that many irrigation users are wasteful of water. If regulations over irrigation diversions become reality, what can be expected? Based on hydroelectric relicensing experience, irrigation interests can expect:

- Extensive consultation and involvement with the natural resource agencies to identify impacts and solutions to environmental problems;
- Expensive studies to identify problems and remedial solutions; and
- Complicated, costly compliance with mandated instream flow, water quality, habitat improvement, and recreational use goals of the resource and regulatory agencies.

In tight economic times, increased costs to meet new regulations may have severe negative impacts on the economic viability of irrigated agriculture in certain regions of the country. It behooves the agricultural water user groups to begin strategic planning to deal with the prospect of increasing regulation of water diversions. This should include: development of basic understandings of how irrigation diversion projects are currently impacting environmental resources; evaluation of how potential changes in operation may affect farm revenues; and anticipation of potential regulatory compliance requirements.

MITIGATING ENVIRONMENTAL IMPACTS OF WATER MANAGEMENT PROJECTS: EXAMPLES

Michael Day¹

Brian Ehlers¹

Dale Melville¹

ABSTRACT

Water management projects undertaken by public agencies often require mitigation measures to reduce or offset potential environmental impacts. Negotiating, designing, administering and constructing mitigation measures often involves significant expenditures of time and money. The resulting costs and delays can affect the feasibility of the project. Creative ways can often be found to satisfy environmental concerns without "killing" the project. Examples from recent projects in California's San Joaquin Valley by Laguna Irrigation District, Dudley Ridge Water District, James Irrigation District, Raisin City Water District and the Lost Hills Water District are presented and discussed.

INTRODUCTION

Projects which improve water management, including those designed for water conservation, groundwater recharge and drainage management, are generally supported by public opinion, national and state governments and by many environmentalists. However, when public agencies seek to undertake these types of projects, they quite often find that potential environmental impacts, even relatively minor ones, stand as road blocks to funding, design, construction and operation. As a result, project managers and engineers find themselves spending considerable time, and the agency's money, seeking ways to mitigate those impacts. This paper summarizes the authors' experiences with several water management projects undertaken by irrigation and water districts in the San Joaquin Valley of California.

¹ Registered Civil Engineers, Provost & Pritchard Engineering Group, Fresno, California

CEQA PROCESS

The California Environmental Quality Act (CEQA) of 1970 governs the actions that local agencies must take when sponsoring a construction project to ensure that protection of the environment is included in the planning process. CEQA is California's version of NEPA, the National Environmental Policy Act. This paper does not attempt to explain CEQA or NEPA.

Condition of Funding

Projects constructed by local agencies, but funded by state bond issues (like the projects given as examples later) are especially subject to delays during the CEQA process. Since funding for design and construction is contingent upon the CEQA process being completed, other parties have the power to bring a project to a complete stop by raising objections during the CEQA process. Some parties have been known to take advantage of this process and hold a project hostage to their own agenda.

Endangered Species Act

The most common potential environmental impacts of water management projects which become an issue in the San Joaquin Valley are those which involve threatened and endangered species. The Endangered Species Act (ESA) governs the actions which must be taken when there are potential impacts to plants or animals listed as threatened or endangered. Both the Federal government and the State of California have their own lists of threatened and endangered species. When a plant or animal on one or both lists exists, or is suspected to exist, within or near the project site, the regulatory agency(s) responsible for protecting that species will require mitigation measures to offset the potential impacts (whether perceived or real).

In the San Joaquin Valley, the agencies responsible for protecting endangered species are the California Department of Fish and Game (DFG) for State listed species and the United States Fish and Wildlife Service (USFWS) for Federally listed species.

The ESA is an incredibly powerful law. It in essence places the protection of threatened and endangered species above all other considerations. Practical and economical factors are not considered in its enforcement. It has even been interpreted by a judge as meaning that protection of threatened and endangered species takes priority over the national defense.

Because of the ESA's strength, the agencies which administer it are in a position to dictate mitigation measures. In the example projects given, the DFG is further empowered by the fact that it is a branch of the same State government which is providing loan funds to the projects.

Other Environmental Impacts

Other potential environmental impacts encountered by some water management projects involve other powerful laws or regulations including the Migratory Bird Treaty Act, wetlands laws, the Clean Water Act, the State Fish and Game Code, archeological protection laws and the California Toxic Pits Cleanup Act. Project conflicts with any of these laws or regulations must be resolved during the CEQA process before the project can proceed.

Mitigation Measures

When there is a potential conflict with the ESA, other laws or regulations, the project manager is in a position to negotiate mitigation measures with the party who raised the objection. Sometimes this can be as easy as hiring a biologist to perform a survey to demonstrate that the listed species does not exist in or near the project area.

Other conflicts may require altering the project's alignment, changing the design of the project, adding new facilities for wildlife enhancement, purchasing other lands to set aside for wildlife habitat, applying for a streambed alteration agreement, etc. Generally, on water management projects of the size the authors have dealt with (relatively small compared to major water supply projects sponsored by the U.S. or State governments) there is a way to satisfy environmental concerns. The challenge is to find a resolution which minimizes additional costs and time delays to the project.

Looking for Win-Win Solutions

Often the key to resolving environmental concerns lies in looking for "win-win" situations, i.e. looking for opportunities to satisfy the environmental concern, but in a way which also benefits the project's agency. Finding the win-win situation usually requires meetings with the concerned parties to brainstorm and negotiate a mutually agreeable resolution. This process demands that the project manager look at the project from different viewpoints and think in creative, innovative ways.

Don't Expect Reasonableness

To the sponsoring agency, the concerns of those who raise objections during the CEQA process are sometimes unreasonable. But whether they are reasonable or not, the agency rarely has a choice but to address those concerns since the project cannot proceed otherwise. Some of the example projects discussed later encountered objections with questionable reasonableness.

Costs of Mitigation Measures

Even when win-win situations are found, mitigation measures invariably involve substantial costs. Not the least of which are various consultants' fees incurred during the resolution process. Although the costs may be substantial, they must be maintained at a level not to kill the project. Mitigation costs on the example projects were on the order of 1 percent of the total project cost.

Time Delays

Perhaps the greatest effect that the CEQA process has on water management projects are the time delays that usually result from the need to mitigate environmental impacts. The CEQA process for a project which is declared categorically exempt or for which a negative declaration is prepared and is not challenged may only take a few months. But a mitigated negative declaration or the preparation of an environmental impact report can take several months or even years to complete. The time delays often push back construction for similar periods of time. Project managers and sponsoring agencies must learn to anticipate time delays and plan the project schedule accordingly.

Often CEQA is not the only process delaying a project. For instance, the agency administering the loan may have other conditions that must be met by the project sponsor before funding can be disbursed. Agreements or permits with other agencies may be necessary; public hearings and other activities may also effect project schedules.

EXAMPLE PROJECTS

Examples of water management projects for which mitigation measures were required are presented below. A summary of the specifics of each project is given for each project in Tables 1 through 5, while the following text discusses the unique aspects of each project. Figure 1 shows the location of the districts involved.

Laguna Irrigation District's South Island Canal Project

When the Laguna Irrigation District decided to pipe its South Island Canal (an earthen canal with high seepage losses) the DFG objected that piping the canal would result in loss of habitat for shorebirds. In spite of the fact that District or DFG staff had never seen shorebirds on the banks of the canal, a mitigation agreement was eventually reached in which the District would construct a new regulation reservoir as part of the project to provide alternative habitat.

A regulation reservoir had been needed by the District, and a win-win situation began to develop. The regulation reservoir was designed with input from the DFG to maximize shoreline and shallow water for wading shorebirds. The large shoreline with interior levees provided cells in the reservoir, allowing the District to operate all or only a portion of the reservoir, whereby seepage losses from the reservoir can be minimized when only minor flow regulation is needed.

Dudley Ridge Water District's Service Area 3 Improvements

The Dudley Ridge Water District replaced earthen canals in its Service Area 3 with concrete lined canals and pipelines. The DFG objected that the project would reduce shorebird habitat, San Joaquin Kit Fox dens could be disrupted during the construction and the lined canal would block kit fox movements. A mitigation agreement eventually was negotiated in which the District (1) constructed an island in an existing regulation reservoir to provide habitat for shorebirds, (2) imposed construction restrictions on the earthwork activities and provided crossings for kit fox over the newly lined canal.

Although the agreement cost the District some time and money, it also provided some benefits. The creation of the island in the regulation reservoir was coordinated with an expansion of the reservoir to provide the District with needed additional regulation storage. The restrictions on earthwork never became a factor during construction, and in the design phase, it was mutually concluded that the new and remodelled canal structures could also serve as bridges for kit fox crossings.

James Irrigation District's Eastside Canal Lining

The DFG and USFWS were concerned that construction activities from James Irrigation District's project to reduce seepage losses by concrete lining and piping its eastside canals would kill Fresno Kangaroo Rats. After consultations with these agencies the District retained a biological consultant to perform a reconnaissance survey to locate any evidence of

kangaroo rats and their habitat. When the biologist found kangaroo rat habitat and tracks, the District hired the biologist to set traps so he could determine whether they were Fresno Kangaroo Rats or another non-listed species. Six consecutive nights of trapping found only non-listed kangaroo rat species. This process took nine months and over \$25,000 to complete. Obtaining a permit to trap the kangaroo rat was an especially time consuming and frustrating process.

Raisin City Water District's Groundwater Recharge Project

The Raisin City Water District is planning a groundwater recharge project which has also required mitigation measures. The proposed canal alignment was altered to avoid a small parcel of native land (never developed into agriculture because it is a radio tower site) because it was suspected to be potential habitat for the Fresno Kangaroo Rat, San Joaquin Kit Fox, Burrowing Owls and Blunt Nosed Leopard Lizard. The USFWS also insisted that a survey be conducted for kit fox near the proposed recharge basin site because one kit fox had been seen 17 years ago, 5 miles away. The local biologists for DFG were certain that there were no kit fox in the area, but yielded to the USFWS request. The ten-night scent station and five-night spotlight surveys found no kit fox. If kit fox had been found, the USFWS would have required that the District purchase land three times the size of the recharge basin site as set-aside habitat for kit fox. Although the basin site is agricultural land in production, the agricultural field may have been an area "where Kit Fox could browse".

The District questioned the reasonableness of the requirement for a kit fox survey, but spent the money and time required because it had no choice, if the project was to proceed.

Lost Hills Water District's Evaporation Ponds

Since 1986, the Lost Hills Water District has been involved with the operation of farmer-owned evaporation basins for subsurface agricultural drainage. Naturally occurring levels of selenium have been a concern in agricultural drainage along the westside of the San Joaquin Valley since adverse effects to waterfowl were documented at Kesterson Reservoir. Efforts of the \$60 million San Joaquin Valley Drainage Program have had little impact for implementing solutions to drainage and wildlife issues. Pond operators, such as the Lost Hills Water District, are subject to regulatory and political enforcement of the Migratory Bird Treaty Act (MBTA) which could force closure of the evaporation basins to protect against any loss of migratory shorebirds or waterfowl. Beneficial and adverse impacts of evaporation ponds containing parts per billion of selenium and other salts are being weighed by the scientific (and politi-

cal) communities; the question may become whether a 5% adverse impact outweighs a 95% beneficial impact of the evaporation basins to waterfowl.

The costs borne by the Lost Hills Water District to modify ponds in an attempt to mitigate environmental impacts is shown in Table 5. Even with this enormous level of financial commitment related to mitigation, the results of waterfowl impact studies currently being conducted at the request of the regulatory agencies, are likely to recommend significant additional mitigation measures be implemented. In the case of agricultural evaporation basins, even when the CEQA process has been complied with years ago, the compliance with the MBTA continues as pond operators struggle to find economical mitigation measures which satisfy environmental groups.

CONCLUSION

The mitigation of environmental impacts will continue to be a part of the process of constructing water management projects. If current trends continue, the process will become increasingly difficult. Project managers will need to become more skillful in working through the process by anticipating potential environmental concerns early in the planning stage, and by working with biologists and regulatory agencies to develop mutually agreeable mitigation measures.

Hopefully in the future, the country's politicians can be convinced to modify some of the existing environmental laws to balance protection of species with economic and practical considerations, give local fish and wildlife biologists more flexibility in implementing the laws, and streamline the process.



FIGURE I
AGENCY LOCATION MAP

Table 1. Project Summary
Laguna Irrigation District
South Island Canal Project

Project Purpose	Reduce seepage losses
Project Facilities	1.2 miles of 42" and 36" cast-in-place conc. pipe 20 acre regulation reservoir associated water control structures
Total Project Cost	\$536,000
Funding Source	Proposition 44: Water Conservation and Water Quality Bond Law of 1986
Environmental Costs	\$156,293 (29% of total project cost) Preparation and Processing of CEQA Documents Consulting Engineer's Fees: \$3,828 Attorney's Fees: \$240 District Costs: \$500 County Filing Fee: \$25 Subtotal: \$4,593 Construction of Mitigation Measures Design Fees: \$18,000 Costruction of Reservoir: \$124,000 Construction Inspection: \$9,700 Subtotal: \$151,700
ESA Listed Species	Western Snowy Plover – CSC, 2 Long Billed Curlew – CSC, 2
Mitigation Required	Compensation for "loss of habitat" Elected to construct regulation reservoir
Time Required	CEQA Process took 6 months to complete

Codes for Tables 1 – 5

- CSC = California DFG "Species of Special Concern"
- ST = Listed as Threatened by the State of California
- SE = Listed as Endangered by the State of California
- 2 = Category 2 Candidate for Federal listing
- FE = Listed as Endangered by the Federal Govt.

Table 2. Project Summary
 Dudley Ridge Water District
 Distribution System Improvements, Service Area 3

Project Purpose	Reduce seepage losses
Project Facilities	7.7 miles of 12" to 27" PVC pipeline 3.2 miles of concrete lined canal associated water control structures
Total Project Cost	\$3,107,000
Funding Sources	Proposition 24: Clean Water Bond Law of 1984 Proposition 44: Water Conservation and Water Quality Bond Law of 1986
Environmental Costs	\$32,163 (1.0% of total project cost) Preparation and Processing of CEQA Documents Consulting Engineer's Fees: \$5,000 Biological Consultant Fees: \$1,925 Attorney's Fees: \$400 County Filing Fee: \$50 Subtotal: \$7,375 Construction of Mitigation Measures Land purchase (pond site): \$10,330 Design Fees: \$1,160 Earthwork: \$12,525 Construction staking: \$773 Subtotal: \$24,788
ESA Listed Species	San Joaquin Kit Fox – ST, FE Blunt Nosed Leopard Lizzard – SE, FE Western Snowy Plover – CSC, 2 Long Billed Curlew – CSC, 2
Mitigation Required	Restrictions on earthwork activities Kit Fox bridges over lined canal Constructed island in regulation reservoir
Time Required	CEQA Process took 4 months to complete

Table 3. Project Summary
James Irrigation District
Eastside Canal Lining

Project Purpose	Reduce seepage losses
Project Facilities	3.25 miles of 18" to 36" plastic pipe 11.5 miles of conc. lined canal associated water control structures
Total Project Cost	\$4,250,000
Funding Sources	Proposition 82: Water Conservation and Groundwater Recharge Bond Law of 1988 and Certificates of Participation
Environmental Costs	\$25,670 (0.6% of total project cost) Preparation and Processing of CEQA Documents Consulting Engineer's Fees: \$7,800 Biological Consultant Fees: \$13,720 Attorney's Fees: \$1,000 District Costs: \$600 DFG Filing Fees: \$2,500 County Filing Fee: \$50 Subtotal: \$25,670
ESA Listed Species	Fresno Kangaroo Rat – SE, FE
Mitigation Required	Survey and trapping for kangaroo rats to verify that no listed species were present
Time Required	CEQA Process took 9 months to complete

Table 4. Project Summary
 Raisin City Water District
 Groundwater Recharge Project

Project Purpose	Groundwater Recharge
Project Facilities	3 miles of unlined canal 2.75 miles of 66" cast-in-place concrete pipe 68 acre recharge basin associated water control structures
Total Project Cost	\$2,400,000
Funding Source	Proposition 82: Water Conservation and Groundwater Recharge Bond Law of 1988
Environmental Costs	\$28,630 (1.2% of total project cost) Preparation and Processing of CEQA Documents Consulting Engineer's Fees: \$4,125 Biological Consultant's Fees: \$6,600 Attorney's Fees: \$400 District Costs: \$600 DFG Filing Fee: \$1,250 County Filing Fee: \$25 Subtotal: \$13,000 Construction of Mitigation Measures Alignment Change: \$15,000 Post Construction Bio. Survey: \$630 Subtotal: \$15,630
ESA Listed Species	Fresno Kangaroo Rat – SE, FE San Joaquin Kit Fox – ST, FE Burrowing Owl – CSC
Mitigation Required	Changed canal alignment to avoid taking potential habitat. Performed 11 day scent station and 6 night spot-light survey for Kit Fox.
Time Required	CEQA Process took 18 months to complete Election has added a 6 month delay

Table 5. Project Summary
 Lost Hills Water District
 Evaporation Pond Improvements

Project Purpose	Meet State waste discharge requirements Reduce impacts to shorebirds Improve flexibility of pond operations
Project Facilities	Purchase 540 acres of evaporation ponds 5.25 miles subsurface interceptor drains 3 interceptor drainage sumps with pumps 89,300 cubic yards of earthwork 5 transfer structures 1 mile PVC pipe and valving
Total Project Cost	\$2,670,000
Funding Sources	Proposition 44: Water Conservation and Water Quality Bond Law of 1986
Environmental Costs	\$1,169,000 plus \$64,000 per year Capital Costs (Estimated): Construction Improvements: \$650,000 Participation in funding EIRs: \$35,000 Contingency for Wildlife Mitigation Measures: \$394,000 Research Projects: \$90,000 Subtotal: \$1,169,000 Annual Costs (Estimated): Waterfowl Monitoring and Hazing: \$12,000 Water Quality and Biological Monitoring and Testing: \$19,000 Administration: \$5,000 Pond Levee Maintenance: \$8,000 Research Budget: \$20,000 Subtotal: \$64,000
ESA Listed Species	Western Snowy Plover – CSC, 2 Long Billed Curlew – CSC, 2
Mitigation Required	Not determined yet
Time Required	CEQA Process took 6 months to complete 4 years to get loan approved

CENTRAL VALLEY PROJECT WATER SUPPLY SHORTAGES

Chester V. Bowling¹

ABSTRACT

The persistent 6 year drought in the Central Valley of California has increased the focus on water supply decisions made by the Bureau of Reclamation. As a key manager of water resources in California, Reclamation has faced intense competing uses for supplies from the Central Valley Project. The population growth in California and renewed emphasis on environmental issues, particularly endangered species, has challenged project operators and managers to address all aspects of its water allocations. Decisions must be viewed from the perspective of both authorized project purposes and changing priorities of water use.

BACKGROUND

Central Valley Project

The Central Valley Project (CVP) was authorized for construction by the Secretary of the Interior and made subject to Reclamation laws by the Rivers and Harbors Act of August 26, 1937. The 1937 act also provided that the dams and reservoirs "shall be used, first for river regulation, improvement of flood control; second, for irrigation and domestic uses; and, third, for power." Subsequent laws, directives, and orders have expanded the authorized purposes of the CVP.

The CVP consists of 20 reservoirs with a combined storage capacity of approximately 11 million acre-feet, 8 powerplants and 2 pumping-generating plants with a maximum capacity of about 2 million kilowatts, and more than 500 miles of major canals and aqueducts. Most of the project is operated as integrated unit consistent with its planning and design. Two exceptions are the Friant and East Side Divisions which are normally operated independently as single reservoir systems.

There are 2 major watersheds in the Central Valley: the Sacramento River in the north and the San Joaquin River in the south. The 2 river systems join at the Sacramento-San Joaquin

¹Chief, Water Operations Branch, Central Valley
Operations Coordinating Office, Bureau of
Reclamation, Sacramento, California

Delta (Delta) where the waters commingle before emerging through the Carquinez Strait into San Francisco Bay and thence to the Pacific Ocean. While most of the project water supply comes from the Sacramento Basin, more than half of that supply is delivered to agricultural and urban contractors south of the Delta. Because the CVP and the State Water Project (SWP) use the Sacramento River and the Delta as common conveyance facilities, reservoir releases and Delta exports must be coordinated to ensure that each project retains its parts of the shared water and bears its share of joint obligations to protect inbasin uses including the water required to maintain Delta water quality standards set by the State Water Resources Control Board (SWRCB). The Coordinated Operations Agreement (COA) between the United States and the State of California which became effective in 1986 defines the rights and responsibilities of the 2 projects and provides an accounting mechanism to guide operations.

1987-1992 Drought

The Central Valley is experiencing one of the worst droughts of record. Runoff in the Sacramento River Basin during the last 6 water years has been about 54 percent of the 50 year average, only slightly above that of the 1929-1934 period. In the San Joaquin River Basin, these last 6 years are drier than any previous consecutive 6 year droughts. Only the 1976-1977 drought can compare to the severity of the current conditions. While the State as a whole, and the CVP, mitigated the economic impacts of the first 3 drought years with use of stored water reserves, both surface and ground, recent impacts have been more severe. The CVP contractors have seen their deliveries reduced during the last 3 years as discussed later in this paper. Loss of hydroelectric power has significantly increased energy costs for project power customers and many other Californians. The drought has also had an increasingly adverse impact on the quality and cost of recreation. Possibly the most severe impacts of the drought have been on the environment and the fish and wildlife that depend on the forests, wetlands, and rivers for food and habitat. Many of these impacts began with the first dry weather in 1987 and have had accumulative impacts as the drought has continued.

DECISION CRITERIA

The CVP is operated as an integrated unit. Many project demands, for both water and power, may be met by releases from any one of several project reservoirs. Demands in the Delta and south of the Delta may be met from any northern CVP reservoir.

Decisionmaking criteria can be grouped in 5 basic categories: reservoir storage criteria, streamflow criteria, water quality, energy requirements, and water deliveries. These criteria are interrelated to a large degree. Operations decisions are made after considering the criteria in light of current and forecasted conditions. Some of these criteria are summarized below.

Reservoir Storage Criteria

Reservoir storage is a function of inflow and releases. Operators have the responsibility for maximizing the capability to store inflow while also maximizing the amount of water stored to serve water needs. Decisions are made with consideration of not only individual reservoir criteria but those of the entire project. Another dimension is added to the decisionmaking by the need to address CVP storage south of the Delta which can only be filled with water exported from the Delta. This condition leads to questions about the geographic distribution of water in storage, and if or, when the water should be moved from upstream storage to downstream storage.

Flood control is a primary function of several CVP reservoirs. Shasta, Folsom, Friant, and New Melones Dams have flood control criteria determined by the Corps of Engineers. Trinity and Whiskeytown Dams were not authorized for flood control, however, safety of dams criteria (overtopping) at Trinity Dam and power regulation considerations at Whiskeytown Dam have the effect of providing incidental flood protection to downstream areas.

Maintaining adequate cold water pools in project reservoirs to provide satisfactory water temperatures for downstream fisheries has become a significant factor affecting operations. In recent years concerns about temperature effects on salmon production have been emphasized. In 1990 The State Water Resources Control Board ordered the CVP to meet certain water temperature criteria in the Sacramento River between Keswick Dam and Red Bluff. On the Trinity River, the Regional Water Quality Control Board has established water temperature criteria between Lewiston Dam and the confluence of the North Fork Trinity River.

The need for cooler water is greatest in the summer and fall months, particularly for winter-run chinook salmon in the upper Sacramento river. Unfortunately, drawdown of the reservoirs coincide with this need for cold water resources. The large CVP reservoirs have stratified water temperatures, with the coldest water at the deep levels which are not completely accessible. In fact, at Trinity and Shasta Dams, water has

been released from low level outlets, bypassing the powerplants, to maximize its use for temperature control. CVP operators have been managing the project in 1992 to protect endangered winter-run chinook salmon in the upper Sacramento River by keeping as much cold water in storage at Shasta Reservoir as practical. Clair Engle, Folsom, and New Melones have been operated to assist temperature control to the extent that resources allow, however, the endangered winter-run salmon has been the first priority.

Project reservoirs provide numerous recreational activities. Although there are no specific recreational operations requirements, the reservoirs are operated to achieve peak water conservation levels in the late spring or early summer months. This operation coincides with the beginning of the peak recreational season and, thus, provides the optimum recreation benefit in most years. Reservoir recreation does suffer during dry years and has been significantly impacted during the current drought.

Concerns for the following year water supply are manifest in the volume of water (carryover storage) that CVP operators attempt to retain in the reservoirs. In water short years, the objectives for carryover obviously influence the amount of water available to meet the needs that year. The carryover objectives have been established on an annual basis in consideration of current water demands, forecasted water supply, cold water supplies, power system requirements, and other project capabilities. The carryover objective reflects risks of varying future hydrologic conditions beyond the end of the current year. Prudent operations require that carryover storage be high enough to provide protection for dry years, but low enough that water is not needlessly spilled in wetter years. Carryover analyses also address the needs and refill capabilities of individual reservoirs. Because the configuration of the CVP often facilitates use of a combination of reservoirs to meet downstream demands, it is prudent to use the reservoir that has the greatest opportunity to be filled in the following year. The refill capability of CVP reservoirs vary widely based on annual inflow, reservoir storage space, and assumed release requirements. For example, Folsom Reservoir on the American River receives an average annual runoff of 2.8 million acre-feet, has a storage capacity of about 1 million acre-feet, and has minimal release requirements except for flood control during the November through April period in most years. The high refill potential of Folsom Reservoir can be contrasted with the low potential of Clair Engle Reservoir on the Trinity River which receives average annual runoff of about 1.2 million acre-feet and stores 2.4 million acre-feet.

Streamflow Criteria

Streams below project dams support both resident and anadromous fisheries. While resident fisheries are affected by release fluctuations, the anadromous fisheries are the most sensitive and are present in many streams year around. Maintaining water conditions favorable to spawning and later outmigration of the young are the operators' biggest concerns. During the spawning period, care must be taken to attempt to establish releases that can be sustained until the eggs hatch. If releases are reduced and the redds are de-watered, the eggs die. Once the eggs have hatched and the young are ready to leave the rivers and go to sea, migration may be assisted with release fluctuations to encourage downstream movement.

When the CVP was authorized, regulation of flow in the Sacramento River for navigation was recognized as a project purpose. Minimum flows in a specific reach of the lower Sacramento River were to be maintained for commercial navigation. Because the water was held at a year around minimum flow for navigation, water users that divert from the river were able to locate their pump intakes accordingly. For more than 20 years there has not been any commercial navigation in this portion of the Sacramento River, however, navigation flows cannot be eliminated without affecting the pumping capability of the water users. Project operators continue to maintain the navigation flow requirements in most years but have reduced flows in critical water supply conditions.

Water Quality

Controlling salinity in the Delta is a major constraint on project operations. Regulation of Delta outflow is the only method available to the CVP and SWP to meet their shared responsibilities for water quality. The State Water Resources Control Board has established water quality standards for various purposes and under different hydrologic year classifications to be met at locations throughout the Delta in their order, D-1485. The D-1485 standards are more stringent than the CVP contractual standards and, thus, control water quality operations in the Delta.

A comprehensive monitoring system in the Delta provides the operators with near real-time data for daily decisionmaking. Analyses of historical operations and water quality data provide estimates of monthly and annual Delta outflow needs under varying levels of project exports. Operators must coordinate CVP and SWP reservoir releases to meet Delta requirements which consist of Delta outflow, Delta consumptive

use, and project exports. In planning operations sufficient water must be reserved by each project to meet its forecasted obligations in the Delta. To meet full deliveries to CVP contractors south of the Delta, full use of CVP export capacity is required. On the other hand, the SWP currently has some export capacity in excess of its annual supply and can often regulate outflow by temporary reductions in its exports.

The CVP has several other instream water quality concerns. As mentioned previously, water temperatures are important water quality criteria. The SWRCB orders establishing temperature standards in the upper Sacramento River also included standards for turbidity and dissolved oxygen.

At Spring Creek Debris Dam highly toxic acid mine drainage is intercepted and regulated before its release to Keswick Reservoir and the Sacramento River. By a memorandum of agreement with several agencies, criteria have been established for acceptable concentrations of copper and zinc below Keswick Dam. Therefore, outlet releases from Spring Creek Debris Dam are a function of the concentrations of these metals and the release being made at Keswick. Dilution of uncontrolled spills from the Debris Dam are a major concern because the water must be released from Shasta reservoir at times when the water is not otherwise needed downstream. In 1992 almost 100,000 acre-feet of water was released from Shasta Reservoir for such dilution.

Energy Requirements

The enabling legislation for the CVP identifies power as one of the authorized project purposes. Power produced at project power plants is used to meet project pumping loads. It is also marketed to Preference Customers and any excess is banked or sold to the Pacific Gas and Electric Company (PG&E). Revenue from the power sales is used to repay all of the project power feature costs as well as repaying a portion of the project costs allocated to irrigation users.

The objective of the operator is to match energy generation with energy demand with consideration of seasonal energy production and electrical capacity and seasonal demands and contractual requirements. Although hydroelectric generation is a product of water operations, the project often has flexibility in which facilities are used to satisfy the water and power needs. Despite these efforts, often insufficient energy is produced to meet all contractual demands and energy must be purchased from other sources. This energy deficit was recognized before the project was built, and was a partial

cause for the need for a contract with PG&E to "firm" the power from the CVP. Key contract provisions relate to the amount of electrical capacity and energy produced by the CVP, the amount of capacity and energy that can be marketed, and the level and means of capacity and energy support provided to the project.

Water Deliveries

Except in times of shortage, the project will make available the amounts of water specified in terms of its contracts for water service and water rights settlement agreements. Conditions of shortage are defined in the water rights settlement contracts on the basis of specific amounts of forecasted inflow to Shasta Reservoir. For all other CVP water contractors, water availability shortages are determined by hydrologic and storage conditions. There are a number of differing numeric shortage provisions within CVP water contracts, but for planning purposes, all contracts can be grouped as agricultural, urban, or water rights settlements. With the exception of water rights settlement contractors, shortages are allocated equally among contractors from the same service area, to the extent individual contracts and project capabilities permit. In practice, during years of shortage, all agricultural contractors and some urban contractors have received equal reductions in allocations. Some urban contracts prevent shortages until agricultural contractors have been reduced by 25 percent. Sacramento River water rights contractors are limited to 25 percent reductions in availability. San Joaquin River Exchange contractors are limited to a deficiency schedule which approximates 25 percent reductions.

The decision-making process for allocating the water supply available to CVP contractors involves runoff forecasting, operations forecasting, and reservoir carryover storage needs. In simplistic terms, the decision comes down to a comparison of the forecasted conditions resulting from drawing on storage during the current water year to satisfy the allocated water supply with the risks of potential impacts in the following year or years. There is no current set rule curve or formal risk analysis established to make that comparison and decision. However, the current process, which has evolved through 6 years of persisting drought conditions, is a basis for the allocation decision.

Soon after the beginning of the water year, there is a development of operation forecasts for differing levels of assumed water supply during the year. Because of wide variability in weather conditions from year to year, no relatively accurate runoff estimates are available before

February, so the early operations forecasts are based on runoff quantities representative of various year types and carryover storage. The purpose of developing these early forecasts is to provide some initial direction and a method of assessing current and future conditions and preliminary implications of alternative decisions. The operations forecasts yield information on allocations, reservoir storage, releases, electrical generation and capacity, Delta exports, Delta outflow requirements, and Delta inflows on a monthly basis. By developing an array of possible conditions, operators and management can early on evaluate potential problems in advance of the first official water allocations announcement on February 15. Usually, an initial array of operations forecasts is consolidated and presented to management in December. That array is updated in January. The early forecasts may or may not include assumed water supply shortages depending on the initial reservoir storages and the severity of the assumed hydrology of each forecast. The number of forecasts developed are not limited.

In February, the forecasts of runoff and project operations are used to determine the first water allocations announcement for the current year. Water rights contracts contain shortage provisions based on inflow to Shasta Lake, and the contracts require notice of shortages to be given no later than February 15. Actually, all the agricultural contractors need to know about their water allocation as soon as possible so that they can make the decisions. Therefore, when shortages have been necessary, they have been declared in February, on the basis of a conservative forecast. This strategy avoids the likelihood of imposing a greater shortage later when substantial investments have already been made. The shortages can and have been relaxed subsequent to the February announcement when improved hydrologic conditions increase the runoff and reservoir carryover storage projections. The shortages to water rights contractors must be rescinded when the forecasted Shasta inflow exceeds the specific contractual provisions while other contractors may continue to be subject to shortages on the basis of insufficient water availability.

The water supply decision reflects assessments of both total reservoir storage upstream of the Delta and individual reservoir storages. Because the integrated project operations are focussed on Delta requirements, the total storage available to meet those requirements is the basic measurement of water supply. And because the Delta requirements include project exports to satisfy deliveries of the declared water supply, the process can be iterative to achieve the balance between storage and water supply. The storage levels in individual reservoirs are subject not only to the water supply needs but also to the

geographical distribution of precipitation during the year and minimum streamflow needs below each reservoir. The monthly operations forecasts are used to identify both total and individual reservoir storage needs and impacts.

Normally a median forecast (50 percent exceedance probability) is used to determine the water allocations to water rights settlement and other project contractors. More conservative forecasts are used at the same time to assess the effect of possible subsequent dry conditions to project operations. In years of reduced storage and project flexibility, a very conservative (90 percent exceedance) forecast has been used to reduce the risk of subsequent conditions being drier than the initial forecast. This practice may result in the allocation of deficiencies in deliveries to contractors in February which are rescinded later; however, the risk of not imposing deficiencies in February which may be warranted in later forecasts is reduced substantially. Conservative forecasts have been used in water allocation decision-making in water years 1989, 1990, 1991, and 1992.

PAST WATER DELIVERY DECISIONS

Project water deliveries under long term contracts were reduced in 1977, 1990, and 1991. In 1977, 1991, and 1992 water rights settlement contract deliveries were reduced. In 1989, water delivery reductions were announced for all long-term contractors and water rights contractors, but were later restored. Interim water delivery and deliveries under temporary contracts were suspended in 1989.

The rationale for each year's water allocation decisions has varied depending on current conditions, operations objectives, economic factors, and availability of alternative sources of water. Still the process employed in making this decision, the factors considered, and the timing of the decisions will have much in common from year to year. The water allocation decision has been made over the last 5 years in a management team situation. The CVP operators have presented recommendations and forecasted information to management who have made the final decisions. It is informative to consider the decisions made in past years, and the eventual outcome of those decisions.

Water Year 1977

This was the driest year of record for the CVP. Water deliveries were reduced to all contractors for the first time in CVP history. Water rights holders received their minimum

supplies, 75 percent; agricultural received 25 percent, and urban 25-50 percent. Despite the delivery reductions, reservoir storages had to be drawn down during the water year from 3.6 million acre-feet (MAF) to 1.3 MAF, lowest in project history. The reservoir drawdown in 1977 was not so much a discretionary act as it was the combined result of the low runoff and many inflexible requirements on project operations. By the end of 1977, however, the major CVP reservoirs were at or near their minimum levels for multipurpose operations. Fortunately, very wet conditions in 1978 ended that drought and water deliveries were supported at "demand" levels until 1989, the third year of the current drought.

Water Year 1988

This was the last year in which CVP contractor water deliveries were not reduced. It is noteworthy that the February "most probable" water supply forecast that year was only slightly below normal. Based on the forecasted conditions, the Bureau of Reclamation made a commitment to full water deliveries early in the year even though the months of February and March were extraordinarily dry. Actual runoff in Water Year 1988 was equivalent to about the 95 percent exceedance level of the February forecast. CVP projected storage was reduced from 6.3 MAF at the beginning of the year to 4.6 MAF at the end of water year 1988.

Water Year 1989

In February 1989, when the water supply forecasts were indicating a high probability of another "critical" runoff year, the Bureau adopted a strategy for assessment of water delivery capability with a reduced water supply. The main elements of this strategy were: 1) To determine CVP water available for delivery by using a forecasted supply that has a 90 percent chance of being exceeded; and, 2) To establish an objective for system carryover storage for the end of water year 1989 to prepare for a subsequent "critical" runoff year. An initial objective of 3.6 MAF was adopted for carryover storage as it would enable the CVP to operate in water year 1990 under conditions similar to water year 1977. In other years, carryover storage was defined as the level needed to protect project capabilities for one year during a repeat of the historical worst-case conditions.

Using the forecasts based on February 1 conditions, water deliveries were estimated to be 75 percent for water rights holders, 50 percent for agricultural contractors, and 50 to 75 percent supply for urban contractors. These allocations were confirmed based on March 1 conditions. During March 1989, the

entire Central Valley experienced extremely wet weather, and forecasted conditions changed accordingly. Full water deliveries were restored with the exception of interim and temporary contracts. Central Valley Project reservoir storage increased from the initial forecast of 4.6 MAF to 5.1 MAF by the end of water year 1989.

Water Year 1990

In February 1990, the water supply forecast was for a "critical" runoff year. Using the same criteria as 1989 for assessing water delivery capability, the Bureau announced in February that 1990 water deliveries would be 75 percent of contractual supplies for water rights, 50 percent for agricultural contractors, and 50 to 75 percent for urban contractors. Subsequently, weather conditions were so dry that the 90 percent exceedance runoff forecasts were reduced in updates made in March, April, and May. The Bureau confirmed the planned water deliveries, although projected carryover storage was reduced to about 2.9 MAF. The extraordinary and unseasonable storms of late May 1990, provided a major boost to CVP capabilities. Water rights holders were restored to 100 percent deliveries based on the Shasta inflow criteria. Other contractors' supplies were not increased across the board, but additional water was retained in storage, and some additional deliveries were made under hardship criteria. Carryover storage at the end of Water Year 1990 was 4.0 MAF, down from the previous year's 5.1 MAF but still a major recovery from the conditions forecasted as late as May.

Water Year 1991

Until March, 1991 was drier than 1977. The 90 percent exceedance forecasts based on February conditions indicated that the CVP could only support deliveries at 1977 levels (75 percent to water rights holders, 25 percent to agricultural contractors, 25 to 50 percent to urban contractors), and then only by drawing storage down to 0.6 MAF. By March, forecasted conditions were unimproved. Then, during the wettest March on record, several consecutive storms greatly improved the water supply forecast. Despite the wet March, Water Year 1991 was still the driest year of the 5-year drought. Water deliveries were not generally increased, although "hardship" deliveries were approved. Carryover storage at year-end was 3.3 MAF, down from 4.0 MAF the previous year.

Water Year 1992

This year planning for water deliveries and carryover storage was complicated by not only the persistence of the drought but

also by our consultation with the National Marine Fisheries Service (NMFS) pursuant to Section 7 of the Endangered Species Act. In the spring of 1991 Reclamation requested formal consultation with respect to effects of CVP operations on the winter-run salmon in the Sacramento River. After discussions between Reclamation and NMFS, we began to develop a document entitled Central Valley Project Operations Criteria and Plan (CVPOCAP) (USBR 1992). To provide further information for the ESA consultation we also initiated work on a Biological Assessment of the impacts of CVP operations on the winter-run salmon and the bald eagle. Late in 1991 Reclamation and NMFS agreed to focus the CVPOCAP and Biological Assessment (USBR 1992) and the Section 7 consultation on 1992 operations so that a Biological Opinion (NMFS 1992) could be completed by NMFS prior to February 15, 1992, when initial water allocations would be made.

On February 14 NMFS issued an opinion that found 1992 CVP operations were likely to jeopardize the continued existence of the winter-run salmon. However, the opinion identified a reasonable and prudent alternative consisting of a set of actions that Reclamation in cooperation with the California Department of Water Resources (CDWR) would implement to avoid jeopardy in 1992. These actions include: 1) maintaining minimum flows from Keswick Dam to ensure safe rearing and downstream passage of juvenile winter-run salmon; 2) maintaining specific daily average water temperatures in the 26 miles of spawning grounds of the upper Sacramento River between Keswick Dam and Balls Ferry to ensure optimum survival of eggs and emergent fry; 3) opening the Red Bluff Diversion Dam gates for a longer period to time to improve passage of adult and juvenile salmon; 4) closing the Delta Cross Channel gates for a specific period to reduce diversions of juveniles into the central and south Delta; 5) modifying operations of the Suisun Marsh Salinity Control Structure to reduce diversions of juveniles into Montezuma Slough; and, 6) establishing an operations and management group to ensure that the actions called for by the reasonable and prudent alternative are implemented.

Through January 1992 storage in CVP reservoirs remained at levels lower than at any time since 1977 and early forecasts of runoff were again critically dry. The initial water delivery allocations announced by Reclamation in February recognized the need to conserve water for 1992 and 1993 to support sufficient deliveries to help avert health, safety, and economic hardship problems and to assist in meeting the reasonable and prudent alternative. Those initial allocations were 50 percent to Sacramento River water rights contractors, 50 percent for urban contractors, no supply to agricultural contractors, and a target of 50 percent of historical supplies for wildlife

refuges. For Sacramento River water rights holders and agricultural contractors, this was an unprecedented reduction. Despite the significant shortages, the 90 percent exceedance forecast showed a carryover storage of about 2 MAF, down from 3.3 MAF at the beginning of the water year.

Precipitation in February and March improved the CVP water supply outlook. On March 20, 1992, Reclamation announced that agricultural contractors would receive a 25 percent supply, urban contractors would receive 75 percent of historical use, Sacramento River water rights contractors were restored to a 75 percent supply, and wildlife refuges would be targeted at 75 percent of historical use. The supply for the San Joaquin River Exchange contractors remained at 75 percent as previously announced. At this time the reservoir carryover storage projection had improved to 2.8 MAF.

Since the March 20 declaration, the overall water supply condition has not changed materially. Through water exchanges, an allocation of some hardship water supplies is being made available to agricultural contractors and to refuges. The reasonable and prudent alternative was modified in April by including restrictions on CVP and SWP Delta exports from April 11 through April 30 to minimize entrainment of juvenile winter-run salmon at the export facilities. To-date we have been attempting to operate in accordance with the provisions of the NMFS biological opinion.

FUTURE WATER DELIVERY DECISIONS

The water supply decisions in 1993 and beyond will be shaped by not only hydrologic conditions but also by Section 7 consultations and by decisions of the SWRCB on Bay-Delta water quality standards. Reclamation is proceeding with a long term CVPOCAP and Biological Assessment in cooperation with the CDWR that would permit the NMFS to issue a long term biological opinion prior to February 1993. Action is expected by the SWRCB on October 1, 1992, to establish interim water quality standards for the Delta.

Obviously, we are all hoping for good precipitation in the next several years which would allow the CVP to meet as much of its contractors' needs as practical while improving fish and wildlife conditions.

REFERENCES

- (USBR 1992) Bureau of Reclamation, Mid-Pacific Region, February 1992. Interim Central Valley Project Operations Criteria and Plan
- (USBR 1992) Bureau of Reclamation, Mid-Pacific Region, February 1992. Biological Assessment for U. S. Bureau of Reclamation 1992 Central Valley Project Operations
- (NMFS 1992) National Marine Fisheries Service, Southwest Region, February 1992, Biological Opinion

**DROUGHT, SUPPLY SHORTAGES AND E.S.A.
CAN THE FARMER SURVIVE**

JEAN P. SAGOUSPE*

My name is Jean Sagouspe and I am a farmer from Los Banos, California. Los Banos is a small farming community on the westside of the San Joaquin Valley. I am the President of the San Luis Water District, (SLWD) which receives its water supply from the Federal Central Valley Water Project, (CVP). SLWD encompasses 52,000 acres of diverse farming acreage which includes row, field, vegetable and permanent crops.

I was born and raised in Los Banos and farm some of the same property that my family purchased in the 1930's. I have been involved in the "conversion" of desert land to highly productive agricultural land and I'm afraid I am now witnessing its return to desert conditions.

In this presentation I will review how the past six years of drought affected my operations and the local area. I will also review what we have done to minimize the impacts and how we have adjusted to survive the current drought situation. Finally, I'd like to tell you what I see for the future.

California is currently experiencing an unprecedented six years of continuous drought. The initial three years of drought had little effect on the way we did business. We had a similar experience with the '76-'77 drought. There were many lessons learned from the previous encounter with Mother Nature that were quite valuable. By taking what we learned from the first time around, we were able to make it through the first two years with minimal effect on farm operations. Generally we survived the first two years of the drought through the operational flexibility of the CVP. Although supplemental water wasn't available, we were allocated 100% of our contract supplies. By the third year the CVP's flexibility was gone and our supplies were cut in half to 1.1 acre feet per acre, (AF/AC).

*President, San Luis Water District; President, Widren Water District

San Luis Water District receives virtually all of its water from CVP surface imports. We have very few wells within the district. It became apparent that with a 50% supply of water for the 1990 crop year, we would need to become more creative to handle our reduced allocation.

1990 adjustments included changes in cropping patterns. Crops were chosen that used less water but still provided an adequate amount of revenue. Making major cropping changes has a tendency to cause an imbalance in the supply and demand curve for these crops. This is precisely what happened. Methods of irrigating changed and systems were replaced, where practical. This led to more drip systems on various crops, use of sprinklers, timing the applications of water and a general expansion into the field of irrigation science. Farmers began using the help of professional firms to manage their water scheduling. Due to the high capital outlay for the systems, uncertainty of water deliveries and the ever increasing cost of the water being delivered, significant changes were difficult to achieve.

As we completed the 1990 crop year we were essentially out of water. (Normally we would have enough water remaining for fall/winter crops and/or pre-irrigation for the following crop year.) This put us in the October/November time period and still a full three months from being able to receive the next years' allocation.

The 1991 year was full of hope and despair. We were hopeful that the rains would return to normal or better, and depressed when they didn't. What eventually came out of the winter of 1991 was the continuation into our fifth dry year and allocations of only 25% of our normal contract supply, (six inches per acre).

This was the beginning of some really anxious moments. We developed management strategies for our 25% supply which basically minimized our losses so we could survive until better times returned. In addition, our water districts, whose only source of income is through water sales, began developing serious financial problems.

Previously controversial and restrictively regulated water marketing options became common place. The price of water skyrocketed to levels that none of us were prepared for. Bankers were backing out of farming commitments previously made. This also marked the first time that water availability was the prerequisite for doing business. There were massive layoffs on the farm that trickled down to related agricultural businesses. Yes, 1991 was a year like no other. There wasn't much that anyone could do except 1) purchase supplemental supplies at unreasonably high cost 2) refine our water usage over the previous year 3) and to idle land. Let me tell you that when a farmer has to idle his land you might as well cut out his heart!

The year was a financial disaster. Many farmers had gambled on the purchase of high priced supplemental well water and water from the State pool, (a statewide water clearing house). As a result of higher production costs and surprisingly low commodity prices this gamble failed. By the time the year was over many were out of business.

As we left behind the disastrous 1991 crop year, many of us felt that the worst was finally over. We would pick up the pieces, reduce the size of our operations and hope that 1992 would be better. It surely couldn't be any worse. We were wrong again; it did get worse. The record setting sixth consecutive dry year not only resulted in continued cut backs for water contractors, but initiated the implementation of the Endangered Species Act, (ESA), on the CVP operations.

The Bureau, along with agriculture, was to find themselves in a new and unique position. The Endangered Species Act was going to play a major role in our future. In the spring the Federal Bureau of Reclamation, (Bureau), announced a 0% supply to agriculture and a 50% supply for urban users. The balance of the water available was to be used for the protection of the endangered Winter Run Salmon by maintaining water quality standards and temperatures set for the Sacramento/San Joaquin Delta system.

What we had previously thought to be as bad as it gets had just gotten much worse. This meant a complete and total disaster for the Westside of the San Joaquin Valley and for much of the State as well.

The Bureau did a wonderful job managing its supplies, mitigating the fish losses and with the help of Mother Nature, was able to ultimately allocate 25% of normal water contract supplies. This was far short of what was needed but much better than zero deliveries.

There isn't much that can be done when you have successive years with cuts in water supply. More and more farmers are at the end of the line and by the end of the 1992 season, unfortunately many will not be in business.

As I look back over the past six years of drought, I ask myself what we could have done differently. I don't think we could have done much else, especially in the past three years. You have to have adequate water to survive! The percentage of savings attainable through new technology is not that significant. In many cases the capital expenditures can't be justified -- and even when they can it's difficult to get necessary financing when you have uncertain supplies, uncertain commodity prices and wildly fluctuating water costs.

As we prepare for the 21st century let's ask one question, CAN THE FARMER SURVIVE? I believe the farmer can survive but new policies must be developed that address the following issues in order to insure survival.

There will have to be fair compensation to growers willing to fallow their lands in order that others with a higher demand might use the water saved.

We must have clear understanding and fair practices for prioritizing available water and its uses. (ENVIRONMENTAL, URBAN, AGRICULTURAL)

We need to work toward major water conservation and storage projects like Los Banos Grandes Dam, Auburn Dam and the conjunctive use of water within the Sacramento and San Joaquin Valley ground water basins.

More reclaimed urban waste water needs to be diverted for agricultural and other irrigation requirements.

Before expanding development, urban areas will need to plan for and secure water supplies.

The Endangered Species Act (ESA) must not be over used by environmental groups to control water diversions, growth, and self serving interests. New Congressional Legislation needs to be carried by a courageous congress to better protect and preserve California's number one industry. (Agriculture - \$21 Billion Annual Output.*)

There is excellent State Legislation encouraging water transfers within California. The State and Federal bureaucratic agencies need to join in the spirit of water transfers and do a better job of facilitating these transfers. Transfers are currently bottled up by the Department of Water Resources (DWR) and the United States Bureau of Reclamation (USBR). Limited rulings developed and imposed by these agencies need to be challenged and evaluated by a court of law.

Local water districts need to have better access to both Federal and State facilities for the wheeling of water. For all water conserved, reclaimed or unused, including CVP and State Project Water, (SWP), the grower/district should receive direct compensation from water marketing opportunities without excessive penalties paid for carriage losses, or wheeling cost to Federal and State agencies.

Water transfers should not be held up by Fish and Game interest beyond reasonable considerations.

The State Department of Water Resources, (DWR), should not monopolize water transfers through the State Water Bank. It should be left up to individuals and districts to strike their own deals and to compete openly with the Water Bank. Consideration needs to be given to third party effects but are being overplayed and used as a vehicle to stop or curb transfers.

Until these issues are resolved the farmer that relies on imported water will be at considerable risk. He may become the next Endangered Species.

*See California Farmer September, 1992, p10, A Tough Season.

AVOIDING PITFALLS IN CANAL AUTOMATION

Dr. B.T.A. Sagar¹

INTRODUCTION

Canal automation has come to age and is now a proven method of ensuring efficient water distribution in large irrigation systems in many countries. It is often opined by some engineers in the water management field that such efficient management of water can minimize the dire effects of droughts on farmers. Automation, if properly designed, can ensure such efficient water management. Automation is defined as "a procedure or control method by which a water system is operated by mechanical and/or electronic equipment that replaces the human observation effort or decision".

Canal automation is a coordinated application of several fields of engineering disciplines such as:

- Canal Designs
- Canal Structures
- Canal Hydraulics
- Hydraulic Transients
- Gates and Hoists
- Automation of Gates
- Telemetry
- Communications
- Electronics
- Computers/Microprocessors

AUTOMATION CONCEPTS AND METHODS

Confusion usually occurs in understanding due to indiscriminate use of terminology without clear definitions. Canal automation primarily involves two basic tasks: operation and control. Each of the tasks is based upon a concept to be followed and a method to implement, as outlined below:

		<u>Concept</u>	<u>Method</u>
A.	Operation	Upstream	Constant U/S Depth
		Downstream	Constant D/S Depth
			Constant Volume
			Controlled Volume
		<u>Concept</u>	<u>Method</u>
B.	Control	Upstream	Local Manual
		Downstream	Local Automatic
			Supervisory
			Combination

¹ Head, Hydromechanical Division, ATC Engineering Consultants, Inc. (ECI), 5660 Greenwood Plaza Boulevard, Suite 500, Englewood, Colorado 80111, U.S.A.

a. Operation Concepts

It should be noted that operation concepts and methods entirely deal with water, whereas, control concepts and methods deal with instrumentation, data acquisition, control gates and their response. An upstream operation concept is used when conditions or constraints upstream of the system govern. Collector systems typically represent upstream operation concept. Downstream operational concept bases operation upon downstream conditions or demands. Most irrigation systems are based upon downstream operation concept.

b. Operation Methods

Operation methods refer to the operation of the canal pool between check structures, based upon the location of a pivot point on the water surface at which the canal depth is maintained constant. Thus, in the constant downstream method of operation, the pivot point is kept at the downstream end of the pool and in the constant upstream depth of operation, the pivot point is maintained at the upstream end of the pool. In the constant volume method, the pivot point is at the center of the pool. In the controlled volume method of operation, pivot point can vary on the pool surface anywhere between the check structures.

However, the difference between upstream control and downstream does not always relate to pivot point. A downstream pivot point can be used for either. In upstream control, the gate immediately downstream of the pivot point is used in maintaining a constant depth. In downstream control, the gate at the upstream end of the reach is used to maintain a constant depth.

It is good to note that a constant downstream method of operation permits the canal banks to slope downward along the canal length, resulting in overall economy. This method, therefore, is more common. However, with the advent of modern techniques of supervisory control methods, controlled volume method of operation is becoming increasingly popular as it offers greater flexibility.

c. Control Concepts

A downstream control concept refers to response of gate(s) at the check structure based upon information of instruments located downstream of the gated structure. Similarly an upstream control concept refers to response of the gate(s) based upon information from instruments located upstream of the gated structure. It must be noted that a downstream control concept is entirely incompatible with upstream operation method. Similarly, an upstream control concept is inefficient with downstream operation concept although may not be impractical.

d. Control Methods

Control methods refer to method of controlling the gates at the check structures in order to implement the selected operation concept and method. The four primary control methods are: local manual, local automatic, supervisory and

combination. A detailed discussion of the various control methods are beyond the scope of this paper and the reader is referred to References 1 and 2. The following are typical cases of automation for canal systems:

Case 1

Downstream operation concept plus downstream constant depth operation method plus upstream control concept using local automatic or semi-automatic supervisory control method.

Case 2

Downstream operation concept plus downstream control method plus upstream control concept using semi or fully-automatic supervisory or combination control methods.

Local manual control method is the historical method of operating the gates manually by a ditch rider. Local automatic control methods use Littleman, Colvin or El-Flo type equipments. While Littleman and Colvin basically fulfill upstream control concept, El-Flo fulfills the downstream control concept. The author has come across many books referring to Littleman and Colvin as suitable for upstream "operation" method which is not a correct statement. It should read as upstream "control" method. The Northern Colorado Water District effectively uses a Littleman controller for the control of their canal system.

e. Manning's Coefficient

It is a known fact that canal lining roughness, which can be described as Manning's n , plays a key role in canal hydraulics. It is almost impossible to pin down the exact value of n during the design stage, as the value can lie between a significantly wide range of values. For example, the value of n can be anywhere between .011 and .016 for concrete lined canals. Several factors influence the roughness and the associated n value, such as workmanship, type of forms and type of lining, vegetation, growth of algae, concrete abrasion, and lining deterioration. Thus, the roughness can also vary during canal operation. It is, therefore, necessary to establish the probable range of values of n appropriate for the lining proposed for the canal during design stage. While the canal size and discharge depths should be based upon maximum probable value of n , it is a safe practice to use lowest probable value of n for computing hydraulic transients including the rate of rise and fall of water depths. The author has come across some designers assuming maximum value of n for hydraulic transient computations as well. Such practice may fail to predict rapid transients with potential to overtop canal banks or pull down the canal lining.

f. Method of Characteristics vs. Implicit Method

The partial differential equations-continuity equation and momentum equation involved in determining hydraulic transients can be solved using either

method of characteristics or implicit method. The USBR program, like USM (unsteady state model), uses method of characteristics. Programs have been developed using implicit method. Some engineers are of the opinion that implicit method may give unreliable results when applied to simulation of emergency flows in the canal if the Courant condition for stability is ignored. The usual condition required is:

$$\Delta t \leq \Delta x / c + u$$

where	Δt	=	time interval assumed in computations
	Δx	=	distance of canal reach in computations
	c	=	wave velocity
	u	=	canal flow velocity

It usually will be found necessary to use smaller time intervals or shorter reaches for a given flow velocity to satisfy the stability criterion when using implicit method to satisfy the above criterion.

g. Gates

Various types of gates have been used in canal systems of which the fixed-wheel, slide and radial gates are the most common. As the gate slots tend to collect silt with consequent increase in friction and uncertain gate response, radial gates should be preferred over fixed-wheel and slide gates for canal automation, as the radial gates need no gate slots and result in overall economy requiring relatively less maintenance. Although gate discharge coefficients are not constant and are not always accurately predictable by algorithms, the discharge coefficients for radial gates can be calculated to a reasonable degree of accuracy by the computer programs using algorithms developed by USBR. While using such algorithms, however, it is important to ensure that the bottom seal configuration of the proposed gates is identical with those used in the USBR standard designs (Figure 1). Flat rubber seal strips should be used for bottom seal of the gate and not other shapes like music note. Otherwise, considerable error could result. Also, care should be taken to locate bottom horizontal beam high enough above the gate bottom seal avoiding flange protruding into flow which will cause flow disturbance and consequent discharge variation. Such a situation can also contribute to gate vibrations and downpull resulting in improper gate response during automation.

h. Gate Hoists

While slide gates necessarily require hydraulic hoists, radial gates permit operation by electric motor operated rope drum hoists, which are environmentally more acceptable since no oil leakage of hydraulic system is involved. Rope drum hoists also respond excellently to automation requirements if variable speed motors are used. Prestretched ropes are desirable to eliminate any potential errors in gate position indication which may be possible due to rope stretch or creep.

Fiber Optics vs. Metallic Cable

For telemetry and supervisory control and data acquisitions (SCADA) systems, the fiber optic case is performed in modern designs over the metallic cable. The following are the advantages and disadvantages.

I. Fiber Optic vs Cable Communication Systems

Advantages

- a. Immunity to electromagnetic and electrostatic fields.
- b. Wide band width for high bit rate capability.
- c. No cross talk between fibers.
- d. Unaffected by lightning or electrical storms.
- e. No government licensing required.
- f. Small size, weight, flexibility and ease of handling surpasses that of multipair metallic cable.
- g. Suitable for continuous data scanning supervisory control and data acquisition systems.
- h. Voice and data can be transmitted simultaneously.
- i. Excellent channel expansion capability.
- j. Long life (35 years).
- k. User has complete control over communication system.
- l. High security against undesired monitoring of communications.

Disadvantages

- a. Short transmission distance without repeaters.
- b. Power is required at repeater locations. If not available, must be provided over metallic wire within fiber optic cable.
- c. Additional electronic equipment is required to convert the electrical signals into light and back to electrical signals.
- d. Special splicing equipment is required.
- e. Special termination and connector equipment is required at termination points.
- f. Repair to buried cable installation is costly and complicated.

II. Twisted Pair Metallic Cable Communication Systems

Advantages

- a. Medium band width and bit rate capability.
- b. No government licensing required.
- c. Suitable for continuous data scanning supervisory control and data acquisition system.
- d. One pair can be used for voice communications.
- e. Additional pairs allow for easy channel expansion capability.
- f. Long life (35 years).
- g. User has complete control over communication system.

Disadvantages

- a. Buried cable susceptible to damage.
- b. Lightning protection for each pair is required.
- c. Special design and filtering is required to reduce cross talk between cable pairs.
- d. Special grounding is required near high voltage lines.

Microwave and Radio Communication Systems are also used in certain conditions where fibre optic or metallic cable is too expensive.

ACKNOWLEDGEMENT

The author acknowledges with thanks the valuable suggestions made by Dr. Henry Falvey, Clark Buyalski and Edward Serfozo.

REFERENCES

1. USBR "Canal Automation Manual", Volume 1, 1991.
2. D. Zimelman, "Planning, Operation, Rehabilitation and Automation of Irrigation Water Delivery Systems", Proceedings of Symposium, Irrigation and Drainage Division, ASCE, July 1987.
3. Ven Te Chow, "Open Channel Hydraulics".
4. Clark P. Buyalski, "Canal Radial Gate Discharge Algorithms and their Use", U.S. publication.

AZSCHED Computer Software for Irrigation Scheduling

Lee J. Clark¹
Edward Martin³

Donald C. Slack²
Fred A. Fox, Jr.⁴

ABSTRACT

AriZona irrigation SCHEDuling (AZSCHED) software provides irrigation scheduling information on 15 crops in up to 60 fields, with different planting dates, soil types and irrigation strategies. AZSCHED uses the soil water balance method for irrigation scheduling with water-use being estimated by a Modified Penman equation and heat-unit based crop coefficients. The weather data are supplied by localized historical weather data supplemented with real-time weather data. Weather data can be input manually or from computer files. An irrigation prediction report is generated in which fields being scheduled are prioritized by date and the amount of water needed to restore the soil profile to field capacity. The program was written in Quick Basic and compiled into a compact, user-friendly and attractive package.

INTRODUCTION

Irrigation scheduling programs have been in use for many years. Of those programs that have been developed, many have had an "Achilles heel" which is evidenced in the fact that they are not widely used. The weakness may have been that: it didn't track water use well, it required too expensive hardware, it used too much memory, it wasn't easy to run, it required too many inputs, it was only useful in a very small geographical area, or it didn't fit a large farm with many fields. These weakness were considered in the development of this software.

¹Director, U of A Safford Agricultural Center, Safford, AZ.

²Professor and Head, Dept. of Agric. and Biosystems Engineering, U of A, Tucson, AZ.

³Extension Irrigation Specialist, U of A, Maricopa, AZ

DESCRIPTION

AZSCHED (AriZona irrigation SCHEDuling) software (Fox, etal, 1992) provides a computer based information system for the management of water applications on up to 60 fields with different crops, planting dates, soil types and irrigation strategies. Twenty field summaries are shown on one screen and three screens make up the 60 fields that can be run by the program at one time. If more than 60 fields are needed, more than one subdirectory can be created so any number of fields could be scheduled. Each of the subdirectories would have to have the weather updated independently. This would give the user the opportunity to schedule fields in different geographical areas with different weather bases. Nine crops were available in the first release of the software, these 9 crops are listed in Table 1 along with 6 new crops which are being tested this year.

Table 1. Crops incorporated in the current version of AZSCHED and new crops that will be included in the next version.

No.	Original crops	No.	New crops
1	Cotton	10	Broccoli
2	Sweet corn	11	Lettuce
3	Wheat	12	Carrots
4	Barley	13	Cauliflower
5	Soybeans	14	Green onions
6	Cantaloupe	15	Potatoes
7	Grain sorghum		
8	Safflower		
9	Late grapes		

The program is menu driven and the user begins by initializing a field. To initialize a field, the following data are needed: The planting date, the crop selection, management allowed deficiency (MAD), irrigation efficiency, the available water holding capacity of the soil and the initial available water content. After these inputs are entered, the program sets up the field using these parameters, a historical weather data base and the Modified Penman equation (Doorenbos and Pruitt, 1977) to predict when the field would next need water. Current weather data and predicted weather data can be added to improve the accuracy of the irrigation prediction. An overview of the menu structure is shown in Figure 1.

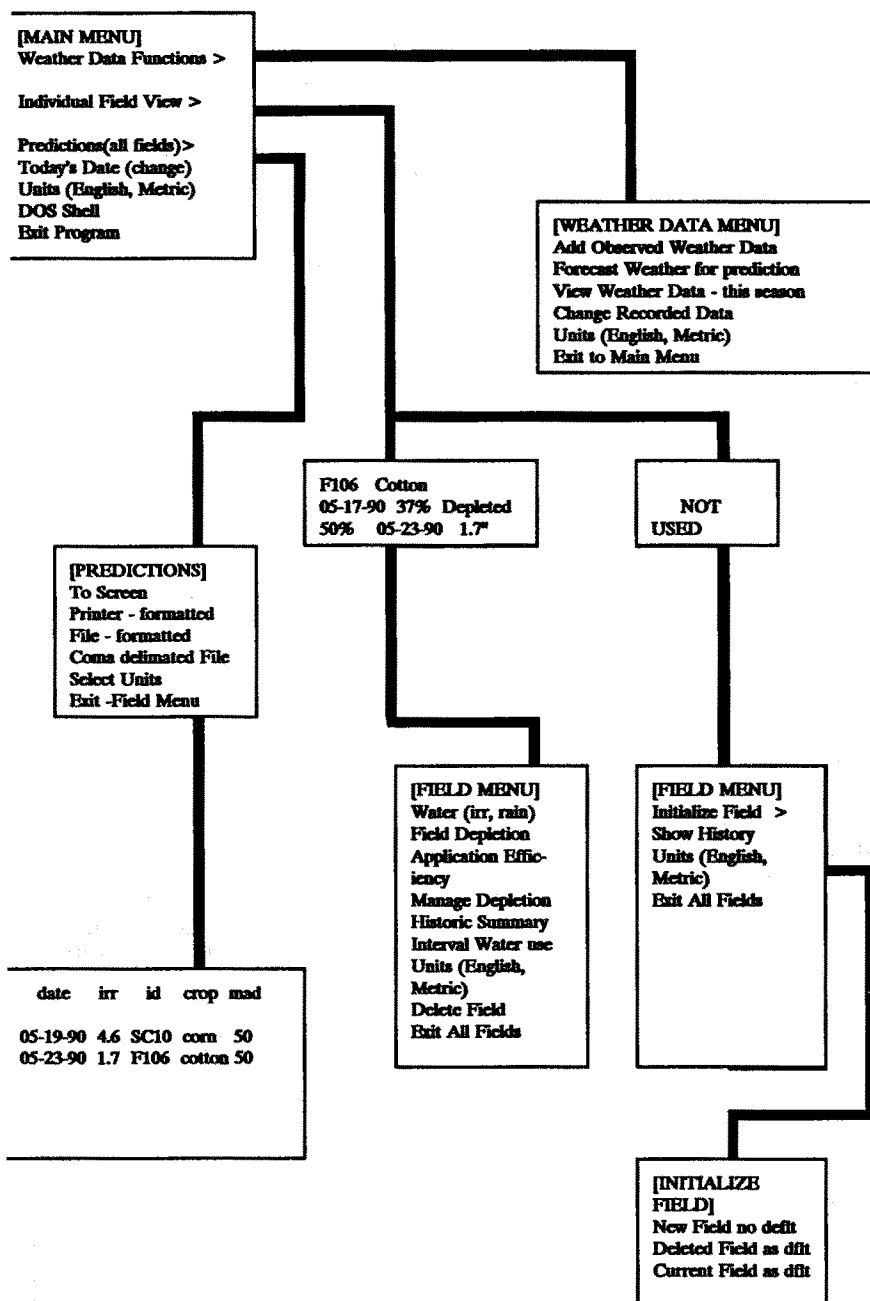

Figure 1. Menu tree from main menu.

The power of the software is shown in its irrigation prediction report. This report, Table 2, lists all fields being scheduled in order of their irrigation needs, showing the date that an irrigation is needed and the amount of water that should be applied to restore the soil to field capacity.

Table 2. Sample irrigation prediction report.

date	irr (in)	id	crop	mad (%)
05-11-91	3.2	FWHT	Wheat	50
05-11-91	4.3	HBAR	Barley	50
05-13-91	3.3	C3WV	Wheat	50
05-23-91	2.7	A240	Wheat	40
09-06-91	3.6	GIR4	Cotton	40
09-07-91	5.4	GIR6	Cotton	60
09-13-91	4.5	GIR5	Cotton	50

METHODS

Soil-Water Balance

Scheduling irrigations involves determining when the soil water deficit will result in an unacceptable level of plant water stress. AZSCHED estimates the amount of soil water in the plant root zone using the soil water balance principle. The soil storage volume for plant available water is determined by the rooting depth of the crop. Roots are grown in the program from seeding depth to the maximum depth (specified in the crop.dat file) at a rate directly proportional to the crop coefficient. The amount of water available to the crop is defined as the difference between field capacity and permanent wilting point. Estimates of available water by soil texture are shown in Table 3.

Table 3. USDA Ranges of values of available water by soil texture.

Soil Texture	Available Water Range (in/ft)
Sand	0.8 to 1.2
Sandy loam	1.1 to 1.8
Loam	1.7 to 2.3
Clay loam	2.0 to 2.6
Silty loam	2.2 to 2.8
Clay	2.4 to 3.0

As soil water is depleted, the plant has more difficulty removing water from the soil, thus decreasing the evapotranspiration from the plant. This decrease in evaporation is accounted for by the use of a dryness coefficient (K_d) developed by Jensen, et al (1971). Soil surface evaporation is estimated using a factor (K_s) from Kincaid and Heerman (1974), which decreases wet soil surface evaporation as the crop coefficient (K_c) increases. The adjusted crop coefficient then is $KC = K_c * K_d + K_s$.

Heat unit based crop coefficients

Calculation of actual crop evapotranspiration (E_{ta}) using a reference evapotranspiration (E_{To}) multiplied by a crop coefficient (K_c) is the basis for most irrigation scheduling programs. Many crop coefficient curves relate K_c to the stage of crop development as a function of time from planting or emergence. For many crops, however, it is recognized that physiological development is more closely related to heat units than to calendar date. Thus in AZSCHED, crop coefficients are developed as a function of heat units. With crop coefficients developed by heat units, the program tracks crop water use more accurately in years that differ from the norm and in different climatic regions.

Crop coefficients are supplied to the program from the crop.dat file. The crop coefficients in this program were normalized by heat units (Scherer et al, 1990a) and are created for use in a location based on the heat units that are received. Figure 2 shows three crop coefficient curves developed from two different sites. Differences are seen at a particular site on two different years. Yuma is a much warmer site than Safford and the year 1991 had a much cooler spring than 1989. It can be seen from the curves that if the heat units are accumulated faster the curve is shifted to the left. This indicates that the crop is developing faster and will need water earlier. In 1991 the Safford curve did not drop off at the end of the season. This indicates that the crop was terminated before its full potential was reached.

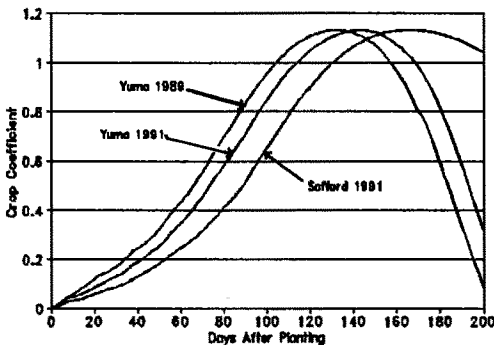

Figure 2 Variation in crop coefficients for cotton at two locations in Arizona

Weather data bases

For accurate predictions into the future, the program uses a historical weather data base. AZSCHED contains historical data bases for the agronomically important regions in Arizona. For areas outside of Arizona, one must select an Arizona region that is similar or develop a separate weather file. The historical weather files contain the following data for each day of the year: Maximum temperature, minimum temperature, maximum relative humidity, minimum relative humidity, 24 hour wind (at 2 meters), day/night wind ratio, and horizontal solar radiation. All of these parameters are used in the Modified Penman equation. Local 5-day forecasts can be entered into the program to supplant the historical weather data base and increase the accuracy of predictions. Real-time weather data from local instrumentation must be entered for maximum accuracy in water use calculations. This data can be inputted directly as raw data files from the AZMET system in Arizona or can be added manually. Locally available data normally consists of maximum and minimum temperatures and sometime humidity information. This information is inadequate to determine evapotranspiration, so default weather data from the historical file supplies the rest of the data necessary for the calculations.

Adapting the program to specific field conditions

Default weather vs. AZMET weather vs. on-farm weather: Default weather is the average of long term historical weather taken from National Weather Service and AZMET records. Long term average values do not reflect the variation of weather from year to year and therefore provide the lowest level of prediction accuracy. On-farm weather information is best if the instruments are properly installed and all the required weather parameters are measured. AZMET (or comparable) weather station data, if located in the same climatic area, will provide prediction accuracy approaching that of good on-farm weather measurements and in most cases exceed that of poor on-farm measurements. In a warmer than normal year, the predicted date of irrigation using good weather data could be as much as 5 days earlier than the date predicted using default weather.

The estimate of soil water holding capacity: The estimate of soil water holding capacity is the most crucial value entered at the initialization of the field. If AZSCHED does not appear to accurately predict irrigation dates, the soil water holding capacities may need to be revised. If the soil water holding capacity is estimated to be greater than the actual value, the predicted date of irrigation will be delayed, resulting in a greater level of water stress than intended by the predetermined management allowed depletion. The program is not designed to handle perched water tables. The plants will have access to water that the program indicates has been lost to leaching. In cases where the water holding capacity of the soil is not accurately known or where perched water tables may be present, percent water depletion in the program may be set to zero after an irrigation that restores the soil profile to field capacity. This will allow the program to run without cumulative errors. Initializing a new field with better estimates of the soil water holding capacity is the best solution, however.

The Estimate of Initial Water Content: Early season irrigation prediction are highly dependent on this estimate. Estimating the initial soil water content at a value higher than the actual value will delay the first irrigation, resulting in higher water stress levels than intended. Estimating a lower initial value will predict a first irrigation date earlier than needed and decrease the irrigation efficiency.

The Measurement of Water Applied: The program accuracy is only as good as the measurements entered. This is particularly true for the volume of water applied. Over estimation of the water volume applied will result in greater stress to the plants, since the volume of water delivered will be less than that entered into the program. Under estimation will result in more frequent irrigations and more water loss through leaching.

The Estimate of Irrigation Efficiency: This value may be quite difficult to estimate depending on the irrigation system. Water may be lost by deep percolation through the root zone, through evaporation or by surface drainage at the bottom of the field. Irrigation efficiency in surface systems will also change during the season, especially when cultivation is stopped and the surface becomes sealed and compacted from the flow of water. Over estimation of irrigation efficiency can result in under application of water and will result in a greater stress for the plants.

CONCLUSIONS

The AZSCHED program has been successfully used for scheduling irrigation on cotton at two locations in Arizona (Clark, etal, 1990b; Clark, etal, 1991a, Scherer, etal, 1990b) and on wheat at one location (Clark, etal, 1990a; Clark, etal, 1991b). As with any irrigation scheduling method, a certain amount of time must be invested to have a successful program. Because of the menu driven structure, the program is easy to learn and can be run by a user with little computer skill. After the fields are initialized the program should be updated at least weekly with weather, irrigation and rainfall data. With practice, the weather data can be downloaded from AZMET and loaded into AZSCHED in less than 15 minutes. Updating each field takes less than 5 minutes. To print out a prediction sheet with all fields listed is almost instantaneous (depending on the speed of the printer).

The AZSCHED program runs on IBM-PC or compatible computers running DOS 2.0 or higher and required less than 512 Kilobytes of RAM.

A manual describing the software and a diskette containing the program are available at a cost of \$10. They can be ordered from:

Agricultural Communications and Computer Support
Department of Agricultural Education
The University of Arizona
715 North Park Avenue
Tucson, AZ 85719
(602) 621-7176 FAX (602) 621-8688

REFERENCES

- Clark, Lee J. and Eddie W. Carpenter. 1990a. A Comparison of Irrigation Scheduling Methods on Durum Wheat, Safford Agricultural Center, 1988-90. Forage and Grain, A College of Agriculture Report, Series P-84, The University of Arizona, Tucson, AZ. 6pp.
- Clark, L.J., E.W. Carpenter, T. Scherer, D. Slack, and F. Fox. 1990b. Irrigation Scheduling on Long And Short Staple Cotton, Safford Agricultural Center, 1989. Cotton, A College of Agriculture Report, Series P-81, The University of Arizona, Tucson, AZ. 5pp.
- Clark, Lee J., E.W. Carpenter, T.F. Scherer, D.C. Slack and F. Fox, Jr. 1991a. Irrigation Scheduling on Long and Short Staple Cotton, Safford Agricultural Center, 1990. Cotton, a College of Agriculture Report, Series P-87, The University of Arizona, Tucson, AZ. 8pp.
- Clark, Lee J. and Eddie W. Carpenter. 1991b. The Use of AZSCHED to Schedule Irrigations on Wheat. Forage and Grain, A College of Agriculture Report, Series P-90, The University of Arizona, Tucson, AZ. 4pp.
- Doorenbos, J. and W.O. Pruitt. 1977. Guidelines for Predicting Water Requirements. FAO Irrigation and Drainage Paper No. 24. Food and Agriculture Organization of the United Nations. Rome. 144p.
- Fox, F.A., JR., T.F. Scherer, D.C. Slack and L.J. Clark. 1992. Arizona Irrigation Scheduling (AZSCHED Version 1.01): Users Manual. Cooperative Extension, Agricultural and Biosystems Engineering. The University of Arizona, Tucson, AZ. Publication number, 191049.
- Jensen M.E., J.L. Wright and B.J. Pratt. 1971. Estimating Soil Moisture Depletion for Climate, Crop and Soil Data. Transactions of the ASAE 14(5):954-959.
- Kincaid, D.C. and D.F. Heerman. 1974. Scheduling irrigations using a programmable calculator. ARS-NC-12. USDA.
- Scherer, T.F., F. Fox, Jr., D.C. Slack and L. Clark. 1990a. Near real-time irrigation scheduling using heat-unit based crop coefficients. Proceedings of 1990 ASCE National Conference on Irrigation and Drainage Engineering. July 9-13, 1990. Durango, CO.
- Scherer, T.F., D.C. Slack, L. Clark and F. Fox, Jr. 1990b. Comparison of Three Irrigation Scheduling Methods in the Arid Southwestern U.S. Proceedings of the Third National Irrigation Symposium. The Irrigation Association and American Society of Agricultural Engineers. pp.287-291.

DETERMINATION OF IRRIGATED CROP CONSUMPTIVE WATER USE BY REMOTE SENSING AND GIS TECHNIQUES FOR RIVER BASINS

David G. Wagner¹

Roger M. Hoffer³

Terence H. Podmore²

ABSTRACT

This paper outlines a method for using remote sensed data from Landsat TM satellites and geographic information systems (GISes) to model the evapotranspiration requirements of irrigated cropland within the Cache la Poudre River basin, a tributary of the South Platte River. The flexibility of a GIS allows the model to evaluate specific crops or combinations of crops growing in any specified area or sub-area of the basin over any fraction of the growing season and to compute the spatially distributed crop evapotranspiration. Development of this model will allow modeling and evaluation of the South Platte Basin which contains a significant percentage of the irrigated lands of the Colorado Front Range. Progress on this project to date includes the classification of irrigated agricultural crops. Five major irrigated crops have been identified using Landsat TM multitemporal data sets and computer aided classification techniques. Crop species classification accuracies range from 65 to 94 percent. These crop maps comprise the crop map data layers for the evapotranspiration GIS model. Additional work to be accomplished in the first quarter of 1993 is the programming of the GIS model and the generation of weather and soils data layers and development of the basin water balance. The basin water balance will be used for checking the accuracy and precision of the evapotranspiration model.

INTRODUCTION

With the development of satellite platforms for remote sensing of vegetation, weather, and soil characteristics, and the development of Geographical Information Systems (GIS), the ability to acquire spatially distributed information about crops, weather, and the water resources is now available to the agricultural engineer and to managers of water resources.

This paper outlines a method for using remote sensed data from Landsat TM satellites and GISes to model the evapotranspiration requirements of irrigated cropland within the Cache la Poudre River basin. The flexibility of a GIS allows the model to evaluate specific crops or combinations of crops growing in any specified area or sub-area of the basin over any fraction of the growing season and to compute the spatially distributed crop evapotranspiration (E_c).

¹ Ph.D Grad. Student, Dept. of Agric. and Chem. Engr., Colo.State Univ.

² Professor, Dept. of Agric. and Chem. Engr., Colo. State Univ.

³ Professor, Dept. of Forest Sciences. Colo. State Univ.. Ft. Collins. CO.

Development of this model will allow modeling and evaluation of the South Platte Basin which contains a significant percentage of the irrigated lands of the Colorado Front Range. Accurate computation, prediction, and management of irrigation requirements in the South Platte River Basin would then allow more accurate allocation of Colorado water resources to the needs of an expanding urban population and industrial base within the State of Colorado and neighboring states.

DESCRIPTION OF STUDY AREA

The Cache La Poudre River basin is the major tributary of the South Platte River, located in north-central Colorado. The study area defined for the project contains the irrigated crop land of the Poudre basin. A small area of the Lone Tree Creek basin adjacent to Greeley, Colorado, contains contiguous irrigated crop land supplied by irrigation canals running through the Poudre basin. Excluding the Lone Tree basin cropland would detract from the GIS model integrity.

The area contains lakes and reservoirs used for irrigation of crops, rural subdivisions, farmsteads, irrigated crops, some rangeland, and river floodplains with wetlands and riverine ecosystems. Fort Collins (population 90,000) and Greeley (population 60,000) are located within the study area.

The Cache la Poudre River flows from west to east along the lower edge of study area. Major land cover classes within the riverine system include riparian vegetation, non-agricultural grasses, quarry-gravel extraction and rural subdivisions common to the river flood plain. The Poudre River is a meandering alluvial river overlaying an unconfined and connected aquifer which supports an extensive gravel extraction industry.

A bench land approximately 30 to 50 feet above the floodplain contains intensively irrigated cropland, rural subdivisions and feedlot operations. Drainage is from north to south with slightly rolling swales under cropping activity. Elevations range from 4650 feet above sea level at the southeast corner of the study area at the river surface to 5400 feet at the highest point in the northwest corner of the site.

THE STUDY PROBLEM

The use of a raster based GIS with a 28.5x28.5 meter pixel (picture element) size allows the variability of vegetation biomass (derived from remote sensed crop data) and associated vegetation transpiration and soil evaporation to more accurately predict the spatial variability of evapotranspiration over the land cover of a river basin. With the ability to correctly assess evapotranspiration over tributary basins or major river basins, basin-wide water management is enhanced. The accurate estimation of evapotranspiration forms the basis of control of almost every use of water in the Western United States. The ability to correctly assess the evapotranspiration of water through vegetation, primarily

irrigated cropland, wetlands and urban irrigation affects the following water management areas:

Trans-basin transfer of water controlled by historic consumptive use of the water rights holders,

maintenance of in-stream flows for the preservation of endangered species (Meyer, 1990),

maintenance of riparian ecosystems,

reduction of nutrients in river aquifers,

change of water from agricultural to municipal use, and

the determination of irrigation water demands and distribution and scheduling of water diversion to headgates at the appropriate time and in the correct amount.

Since evapotranspiration studies traditionally use lysimeter data for either alfalfa or grass reference E_t (a point value), when crop E_t rates are computed, discrepancies arise due to the nonhomogeneity of the crops within a field. When study areas as large as a river basin are considered, the assumptions for homogenous crop or vegetation coverage do not hold. The need for ground truth or ground reference data to verify the evapotranspiration model for large areas is costly. Recent work (Seevers, 1990; Seevers et al, 1990) substitutes vegetation indices in the evapotranspiration computation method as a surrogate for the crop coefficient. Sufficient research has been done to verify the effectiveness of using vegetation indices to eliminate costly development of field reference data by relating the vegetation indices to changes in biomass and leaf area. This study will evaluate the use of vegetation indices and the potential accuracy of that computation method, as compared to the use of crop coefficients in the Penman-Monteith evapotranspiration computation.

Specific objectives

To determine the acceptable levels of accuracy and precision for identifying the types and spatial distribution of agricultural crops at a river basin level and to determine the accuracy and precision measurement parameters.

To determine the magnitude and type of scale-up factors derived from using ET point estimates based on lysimeter evapotranspiration reference data and single station weather data as the basis for spatially distributed GIS-based evapotranspiration models extending over river basins or other large areas.

To determine the difference in precision and accuracy of computation of large area evapotranspiration using crop species based crop coefficients and surrogate vegetation indices derived from Landsat TM satellite imagery.

METHODOLOGIES

The project was developed in two phases; the generation of crop maps as a GIS data layer by remote sensed data from Landsat TM satellite imagery, and the development of a geographic information system model for computing the spatially distributed evapotranspiration.

Phase 1: Remote Sensing And Development of Crop Maps

- a. Assembly of existing digitized data base materials. This digitized map information contains land use, political and geographic information, elevation data for land surfaces as well as water table elevations, and soils information at the county level. Weather data for the study area is obtained from the Northern Colorado Water Conservancy District's (NCWCD) weather net for the basin.
- b. USGS supplied 9-track Landsat TM satellite imagery for May, July and September, 1991, was downloaded to ERDAS Remote sensing/GIS software. Imagery has been previously georectified by the USGS.
- c. The portion of the Landsat scene for the Poudre River hydrologic basin was extracted from the data set.
- d. Using grid sampling techniques, test sites were randomly selected that approximated the proportional amounts of vegetation types within the Poudre River Basin. These test areas were not used for generating training statistics for the classification operation.
- e. The May, July and September images were combined into a multitemporal image
- f. Unsupervised classification techniques were used to develop training statistics for vegetation classification within the study area scene.
- g. The May, July and September non-enhanced 7 band satellite spectral images were classified to Level III of the U.S. Geologic Survey Land Use and Land Cover Classification System (Anderson et al., 1976) using maximum likelihood classification algorithms.
- h. Using image preprocessing techniques, the May, July, September, and combined multitemporal images were enhanced to develop a select number of vegetation indices and image transforms for classification using the same classification techniques described above. The goal for this step was to select indices and transforms which have previously been shown to correlate to biomass, leaf area and evapotranspiration characteristics of irrigated crops. These indices and transforms will be used to determine the effectiveness of classifying transformed images into biomass, leaf area or other surrogate land cover maps (GIS data layers) that will provide equivalent or better

accuracy in modeling evapotranspiration characteristics of the irrigated agricultural crops.

The classified maps were evaluated using information obtained from the NCWCD's Irrigation Management Program, to determine the classification accuracy and precision.

Phase 2: Development of the GIS Model

The general steps used in developing the GIS model are as follows:

Basic and derived data layers needed for the GIS model are as follows:

1. Temperature
2. Wind Speed
3. Solar Radiation
4. Relative Humidity
5. Crop Coefficients or surrogate vegetation indices
6. Vegetation maps (more generally land cover maps)
7. Summary daily evapotranspiration
8. Cumulative growing season evapotranspiration
9. Kriging coefficients for distributing weather data
10. Weather station location
11. Rainfall
12. Soils
13. Districts (for definition of sub-areas)
14. Irrigation water requirements
15. Growing degree days

Process weather data into appropriate data layers. An external data base of weather station data will be used with a weather generation model to preprocess weather data into a spatial data base that will include data layers appropriate for the model run. For example, if daily E_t is desired, the weather generation model will provide a data layer for computing E_t from daily weather characteristics. The weather generation model will probably take the form of a separate GIS.

Using GIS algebra, the GIS is programmed with command functions for developing data layers which can be used to compute reference evaporation. Data layers are wind speed, rainfall, temperature, relative humidity, solar radiation.

Data layers are developed containing crop coefficients for crops identified within the study area. Depending on the evaluation of the effectiveness of surrogate vegetation indices, data layers containing these indices are included.

- d. Data layers containing vegetation classes, reference ET and crop coefficients are used to compute ET for selected NCWCD IMS sites for selected time periods.

Verification of the Model

The model is verified both on a field scale and a basin-wide scale. NCWCD evapotranspiration values for individual fields can be used to verify the model for differing time periods throughout the irrigation season as NCWCD has accurate data for crop types and both reference ET and crop ET values for individual fields throughout the 1991 irrigation season. This time period corresponds to the satellite imagery dates used to develop the model.

- a. With crop data provided from NCWCD, the accuracy of the remote sensed satellite processed vegetation classification is compared to ground verified crop types for specific field sites.
- b. The model output is compared with irrigation ET's computed and used by the NCWCD during the 1991 irrigation season for NCWCD IMS sites
- c. The seasonal river basin ET is computed for all irrigated lands and for urban irrigated lands. A water balance is computed for the river basin for an irrigation season. The difference between river basin inputs and outputs and change in aquifer storage will approximate the consumptive use in the basin.
- d. If satisfactory simulations are achieved indicating conformance to the NCWCD field E_t estimates +/- 10 percent, and conformance to +/- 15 percent of the Poudre River hydrologic basin water balance, the software template is finalized and a demonstration of the model to interested agencies is scheduled.

RESULTS TO DATE

The land cover classification was completed using six data sets containing Landsat 5 TM data for May, July and September, 1991. The data sets included both TM spectral data bands and transformed spectral data in the form of normalized difference vegetation (NDVI) indices and Tasseled Cap transformations. Both multitemporal and unitemporal data sets were evaluated with one, two and three date unitemporal and multitemporal combinations used. Initial clustering with ISODATA clustering algorithms yielded a minimum of 12 land cover categories that effectively represented the land cover category actually found within the study site.

Considering only agricultural crops species, the 15 TM spectral band data set identified most of the predominate crops in the study area at accuracies greater than 86 percent. Lesser prevalent crops such as onions were identified at about 60 percent. The Tasseled Cap transformation identified the four predominate crops at accuracies above 94 percent and the NDVI vegetation

index data set ranked third, identifying the four predominate crops at accuracies greater than 79 percent. The 10 TM spectral band data set for July-September yielded the lowest accuracy in identifying crop species at 40 percent for pinto beans but with alfalfa, corn and sugar beets at accuracies above 78 percent.

ACKNOWLEDGEMENTS

The author wishes to thank Dr. Darell Zimbelman and Gary Hoffner of the Northern Colorado Water Conservancy District for their kind assistance in furnishing agricultural data for the study site. The Landsat imagery was furnished and the work was supported by EROS Data Center, U.S. Geological Survey, Sioux Falls, S.D., as part of a land cover classification project for the North Central area of Colorado - Contract No. 14-08-0001-A0748. The USDA-Agricultural Research Service, Great Plains Systems Research has contributed computer facilities. Dr. Roger Hoffer, Director of the Remote Sensing Program, Department of Forest Sciences, Colorado State University has contributed greatly of his time.

REFERENCES

- Anderson, J.R., E.E. Hardy, J.T. Roach and R.E. Witmer. 1976. A land use and land cover classification system for use with remote sensor data. In *Geological Survey professional paper 964*, pp.1-28. Washington,D.C.: United States Government Printing Office.
- Meeyer, C.H. 1990. *Western water and wildlife: the new frontier*, New York, New York: National Audubon Society.
- Leevers, P.J. 1990. Evapotranspiration Volume Estimates With the Use of a Normalized Difference Vegetation Index Transformation of Satellite Data. *Proceedings: U.S. Army Corps of Engineers Seventh Remote Sensing Symposium, Integration of Remote Sensing with the Physical Sciences. Portland, Oregon, May 7-9,1990*. U.S. Army Corps of Engineers, Portland, Oregon, pp.116-137.
- Leevers, P.J., F.C. Sadowsky, and D.T. Lauer. 1990. An Investigation of Spectral Change as Influenced By Irrigation and Evapotranspiration Volume Estimation in Western Nebraska. *Climatic Change*, 17,pp.265-285.,

GIS AND CONJUNCTIVE USE FOR IRRIGATED AGRICULTURE

J.W. Fredericks¹

J.W. Labadie²

ABSTRACT

A microcomputer based geographic information (GIS) is presented for decision support in conjunctive use of groundwater and surface water for irrigated agriculture. A powerful, yet low-cost, raster GIS for PC's called IDRISI is utilized for preparing and processing grid-based spatial data for MODRSP, a modified version of the USGS 3D finite-difference groundwater model, MODFLOW. Spatially distributed stream-aquifer response coefficients are generated and then used within a generalized river basin network model called MODSIM. The GIS is also used for displaying and analyzing results of conjunctive use schemes. Integration of GIS, MODFLOW, and MODSIM allows analysis of conjunctive use plans with consideration of decreed flow and storage rights, river calls, exchanges, trades, and plans for augmentation. The hydrologic components include: reservoir seepage, irrigation infiltration, groundwater pumping, channel losses, return flows, river depletion flows due to pumping, and aquifer storage. Capabilities of the decision support system are demonstrated on a 70 mile section of the Lower South Platte River, Colorado.

INTRODUCTION

Water has always been the key to the success of agriculture in the West. In a state such as Colorado, where 75% of the water is used for agriculture, the importance of meeting the water needs of irrigated agriculture in quantity and quality will remain a major issue in the 1990's. Faced with the prospect of increased competition for available water from a growing urban sector and a moratorium on new large-scale water projects, irrigated agriculture will have to depend on effective management of currently available resources.

Because of the complexities involved in river basin management, computer based models are finding increasing acceptance as tools to assist water users and water managers in developing improved basin wide and regional strategies. In the western U.S., these efforts are complicated by the administrative and legal constraints dictated by water right issues and the interdependence of surface and groundwater users. Some of the areas where computer based models have been identified as having high potential for providing better decision support include daily water administration, drought contingency planning, voluntary basin wide management, groundwater exchange program evaluation, recharge and augmentation project management, and regional scale modeling to resolve conflicts between urban and agricultural water users (Caulfield et al, 1987).

To support this modeling effort, a microcomputer based river basin decision support system (DSS) has been developed for improved conjunctive use management of

¹Graduate Research Assistant, Department of Civil Engineering, Colorado State University, Ft. Collins, Colorado 80523

²Professor, Department of Civil Engineering, Colorado State University, Ft. Collins, Colorado 80523

groundwater and surface water for irrigated agriculture under appropriation water rights doctrine. A finite difference groundwater flow model (MODRSP) has been linked with a river basin network model (MODSIM) using database management (DBMS) and geographical information system (GIS) technology.

DSS STRUCTURE AND FEATURES

The DSS has been structured around decision support system theory. Decision Support System (DSS) can be defined as " an interactive computer-based support system that helps decision makers utilize data and models to solve unstructured problems" (Sprague and Carlson, 1982). DSS software should have three sets of technical capabilities (Sprague, 1980):

1. Database management software (DBMS)
2. Model base management software (MBMS)
3. Software for managing the interface between the user and the system, the dialogue generation and management software (DGMS).

The DSS has been designed to model long term river basin planning activities, daily river administration, and river management options such as groundwater augmentation. Groundwater modelling of stream-aquifer return flows is done using response coefficients which can be calculated from numerical or analytical methods. Groundwater management is accomplished using a network simulation model which is able to represent even the most complex river basin systems. The DSS can operate in a microcomputer environment and incorporates commercial, non-proprietary, or supported public domain software. Geographical Information (GIS) and data base management (DBMS) system technology is used to process data available from sources such as public domain databases, published maps, or digital maps. The ability to incorporate appropriation water rights, to model stream-aquifer events, and to allocate river basin water resources according to user specified operational rules and demand priorities provides the user with a powerful river basin modeling tool.

The components of DSS are presented in Figure 1.

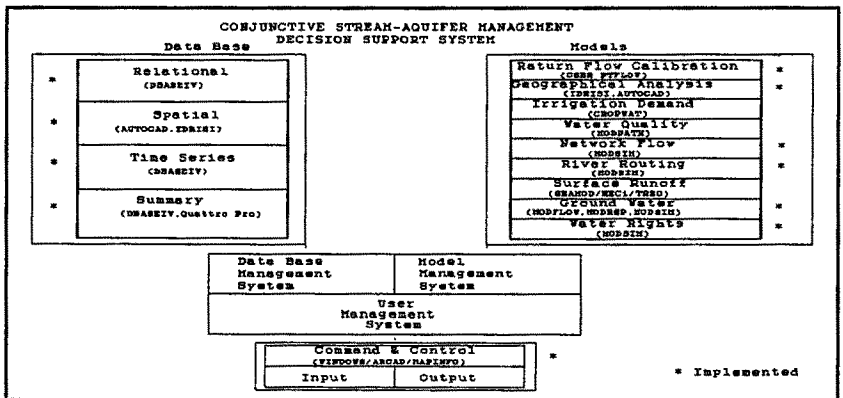

Fig 1: Conjunctive Stream-Aquifer Management Decision Support System

The database component is supported using DbaseIV, a data base management package that can be used to create, organize, and access a database; and Quattro Pro, a spreadsheet package with graphics and database support.

GIS and spatial analysis is supported through several different software packages. IDRISI is a grid based geographic analysis system, developed at Clark University, that is designed to provide inexpensive access to computer-assisted geographic analysis technology. AUTOCAD is a general purpose computer aided design (CAD) program that can be used to prepare a variety of two dimensional drawings and three dimensional models. SURFER is a powerful and flexible tool for creating contour or surface plots of three dimensional data. The USGS General Cartographic Transformation Package (GCTP) is the standard computer software used by the National Mapping Division for map projection computations.

The modeling component is supported by several well documented and recognized water resource models. MODSIM is a river basin network simulation model developed at Colorado State University. MODFLOW is the USGS Modular Three-Dimensional Finite-Difference Groundwater Flow Model. MODRSP, developed at Arizona State University, is a modification of the USGS MODFLOW finite difference model that can be used to calculate drawdown, velocity, storage losses, and capture response functions for multi-aquifer groundwater flow systems. PTFLOW is a USBR river water balance program that can be used to calculate reach gains and losses between stream gages given diversion and inflow data.

A user interface was designed to run under a DOS operating system using WINDOWS, a graphical environment that allows users to run more than one application at a time. It also allows users to access the virtual memory capabilities of the Intel 80386/486 processor, allowing WINDOWS applications to use more memory than is available. The desktop mapping software, MAPINFO, was used to integrate database information with maps. The application language, MAPBASIC, was used to customize MAPINFO to create custom applications, perform sophisticated geographic SQL queries, and create custom menus and dialog boxes.

INVENTORY OF DATA RESOURCES

An inventory of data resources was carried out as part of the DSS development process. Although a number of the data sets reviewed are unique to Colorado, most of the data required to support the DSS are available from local, state, or federal agencies involved in collecting and monitoring water resource data in other States.

The type and amount of data available from the US Geological Survey (USGS) is quite extensive. USGS Ground Water Site Survey Database (GWSI) includes data on depth of well, ground surface elevation at well, specific capacity, transmissivity, well location, pumping capacity, seasonal water levels, and well use. Published groundwater maps which show hydrogeologic characteristics such as well location, bedrock configuration, aquifer delineation, water table contours, saturated thickness, and transmissivity are available for many major aquifers (Hurr, Schneider, and others, 1972). Digital Line Graphs (DLG) providing digital representation of cartographic information such as hypsography (contours), hydrography (water), vegetative surface cover, boundaries, survey control markers, transportation, manmade features, and U.S. Public Land Survey System (township, range, section) are available for most areas. Land Use and Land

Cover (LULC) data can provide information on nine major land classes such as urban or built-up land, agricultural land, range land, forest land, water, and wetlands. The Geographic Names Information System (GNIS) is an automated database system on geographic names. LANDSAT provides satellite photos. Digital Elevation Model (DEM) data is elevation data interpolated from USGS maps. Northern Great Plains AVHRR Data Set is NOAA-9 Advanced Very High Resolution Radiometer (AVHRR) data which is 1 kilometer grid data for bands 1-5 afternoon satellite coverage that has normalized difference vegetative index images.

Another source of data is the Colorado Division of Water Resources. Typical databases include: Water Rights database which contains data on structure type, source, location, use, appropriation date, and decreed amount; Diversion and Reservoir database which provides information on daily diversion and reservoir levels; Well File which includes information on location, well number, uses, well permit number, owner, yield, depth, well elevation, appropriation date, and pumping data where available; Aquifer Water Levels, an annual publication of water levels in various aquifers; Water Talk, a telephone hookup to satellite water monitoring system that provides on line access to streamflow at important stream gage locations; Streamflow database which contains data collected from stream gage network monitoring stations; and Daily Report of River Flows and Ditch Diversions prepared by Water Commissioners.

Cross section data for tributaries and streams at road crossings is available from the Bridge Division of the Colorado Department of Transportation.

US Soil Conservation Service has prepared State-County Soil Digital data (STATSCO) which contains information on soil type, vegetative cover, drainage potential, etc.

The Colorado State Climatologist maintains a Climatology Data Base which contains daily data on precipitation, evaporation, temperature, and solar radiation.

The National Oceanic and Atmospheric Administration maintains: Climatological Data of Colorado, a monthly publication of Colorado climatology data; Evaporation Atlas for Contiguous 48 United States, a published estimate of average and seasonal evaporation for free water surface; and Mean Monthly, Seasonal, and Annual Pan Evaporation for The United States, which provides estimated pan evaporations based on observations from Class A pans and meteorological measurements that can be used to develop free water surface maps.

Bureau of the Census is the source for the Topographically Integrated Geographic Encoding and Referencing System (TIGER files). These files are a compilation of digital maps of the entire U.S. and an accompanying data base that integrates accurate map data with related geographic information and population statistics. The TIGER files include digitized data on hydrography, roads, and political boundaries.

The US Bureau of Reclamation has conducted many river basin hydrologic studies. The South Platte River Point Flow Study is an historic accounting of monthly streamflows for the period 1931-1983 at defined locations along the South Platte River taking into consideration diversions, tributary inflows, and reach gains and losses

Bureau of Land Management has been tasked with preparing the Coordinate Conversion Database that will allow conversion of Public Land Survey data to Latitude-Longitude coordinates; however this is still not available for eastern Colorado.

Bijou Irrigation Company maintains their own detailed records. The Augmentation Report (HRS 1983) provides the engineering data used to develop a plan for augmentation for 196 wells operating under the Bijou Irrigation System. The Well Consumptive Use Data Base contains data on well owner, well permit number, net consumptive use demand for 1985-1991. The Well Decree Data Base contains information on well owner, well permit number, location, decreed pumping rate, and SDF. The Recharge Accounting Forms are monthly accounting forms on recharge amounts for the Bijou Irrigation Company. Project Maps have also been prepared on well and recharge locations.

ROLE OF GIS IN THE MODELING PROCESS

Geographic Information Systems (GIS) provide a number of capabilities which have become essential in the implementation of an effective water management decision support system. A few of the characteristics often attributed to GIS (Loucks, Taylor, French, 1985; Goulier and Forest, 1987) include the ability to display and graphically summarize data input and output, to improve data input and editing, to provide an effective interface between models and modelers and models and data bases, and to improve the comprehension of spatial and time varying information. The DSS integrates several GIS and spatial analysis tools and software packages such as AUTOCAD (CAD/CAM, vector), IDRISI (raster), and SURFER (surface modeling). A number of support utilities were written to convert USGS DLG, USGS DEM, and TIGER files into AUTOCAD DXF and IDRISI file format. The USGS General Cartographic Transformation Package (GCTP) was modified to support AUTOCAD DXF file format. Figure 2 shows steps used to extract digital map data from U.S. Bureau of Census TIGER files (Bureau of the Census, 1989).

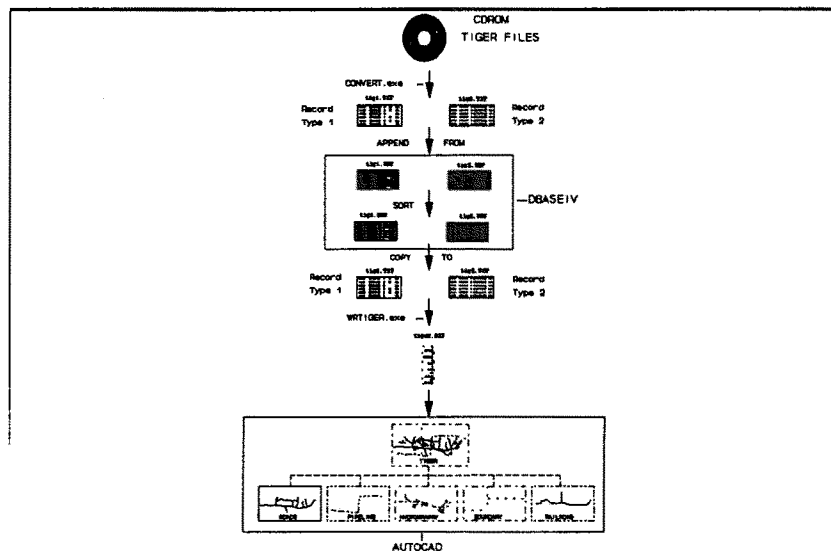

Fig 2: Procedures Used to Import TIGER Files into AUTOCAD

STREAM-AQUIFER MODELS

The various hydrologic conditions usually considered in stream-aquifer management models are listed in Table 1 and graphically presented in Figure 3.

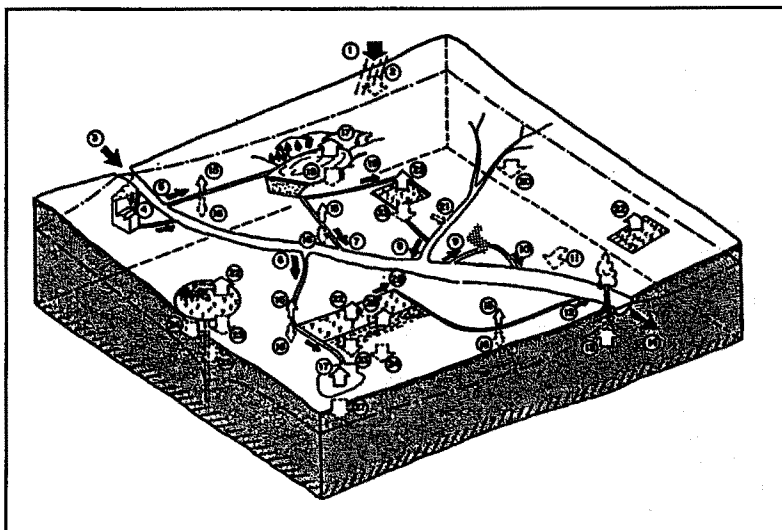

Fig 3: Representation of the Stream-Aquifer System
(Morel-Seytoux and Restrepo, 1987)

Table 1: Correspondence Between Physical Model and Numerical Codes

No.	Description
1	Precipitation
2	Infiltration from precipitation
3	Upstream river inflow
4	Diversion from stream to industrial area
5	Diversion from stream to reservoir
6	Diversion to canal supplying irrigated land
7	Spillway from reservoir to stream
8	Tributary inflow to stream
9	Diversion from stream to municipal area
10	Return flow from city to stream
11	Aquifer return flow to stream
12	Surface return flow to stream
13	Phreatophyte loss
14	Downstream river outflow
15	Canal evaporation (e.g., diversion and reservoir spill canal)
16	Canal recharge to aquifer
17	Evaporation from reservoir and artificial recharge area
18	Reservoir recharge to aquifer
19	Reservoir release to supply area
20	Tributary recharge to aquifer (stream not in hydraulic connection with the aquifer)
21	Aquifer return flow to tributary
22	Evapotranspiration from cultivated area
23	Infiltration from irrigated area
24	Effective infiltration from irrigated or bare soil area
25	Aquifer withdrawal by pumping well
26	Evaporation from bare soil
27	Area of artificial recharge to aquifer
28	Surface drainage from irrigated field

The stream-aquifer modeling process has traditionally been viewed as a saturated groundwater flow problem (Pinder, 1988). Several of the more common modeling methods include:

- * Channel Water Balance (Schafer, 1979; Wright, 1980). This method uses multiple linear regression based on water balance equations to determine time and spatially variant return flow coefficients.
- * Glover's Analytical Solution (Glover, 1978; Labadie, et al, 1983). The linear form of the Boussinesq partial differential equation for one dimensional groundwater flow is used to generate sets of response coefficients for different groundwater flow processes.
- * Stream Depletion Factor Method (Jenkins, 1968; Moulder and Jenkins, 1969; Taylor and Luckey, 1972; and Hurr, Schneider, and others, 1972; Warner, Sunada, and Hartwell, 1986). The Glover equation is solved graphically; dimensionless curves and tables are developed to compute the rate and volume of stream depletion by wells. Regional groundwater numerical models have been used to develop SDF factor contour maps.
- * Finite Difference Numerical Model (McDonald and Harbaugh, 1988). The partial differential equation for groundwater movement in a heterogeneous and anisotropic medium is solved using a finite difference method. This method uses a finite set of discrete points or grids to represent the system and replaces the partial differential equations with terms calculated from the differences in potentiometric head at these grid points. The result is a system of simultaneous linear difference equations.
- * Discrete Kernel/Response Function Approach (Maddock, 1972; Morel-Seytoux and Restrepo, 1987; Maddock and Lacher, 1991). Linear system theory is applied to the groundwater flow equation. The response of the groundwater system due to external excitation such as pumping, recharge, or infiltration at any point or time can be expressed as a set of unit coefficients independent of the magnitude of the excitation. Integrated with a finite difference groundwater model, resultant flows can be superimposed to determine net effects at a single location due to a series of excitations or at a series of locations due to a single excitation.

The DSS allows a user to model stream-aquifer interaction using the discrete kernel/response function approach, the Glover equations, or predefined SDF values.

GENERATING STREAM-AQUIFER RESPONSE COEFFICIENTS

The DSS uses MODRSP (Maddock and Lacher, 1991) to generate numerical stream-aquifer response coefficients. MODRSP, a modification of the USGS MODFLOW finite difference model (McDonald and Harbough, 1988), can be used to calculate drawdown, velocity, storage losses, and capture response functions for multi-aquifer groundwater flow systems. Capture response functions can be generated for stream-aquifer leakage, reduction of evapotranspiration losses, leakage from adjacent aquifers, flows to and from prescribed head boundaries and increases in natural recharge or discharge from head dependent boundaries. (Maddock and Lacher, 1991A).

The procedures required to generate spatially distributed stream-aquifer response coefficients for use in a stream-aquifer management model are shown in Figure 4.

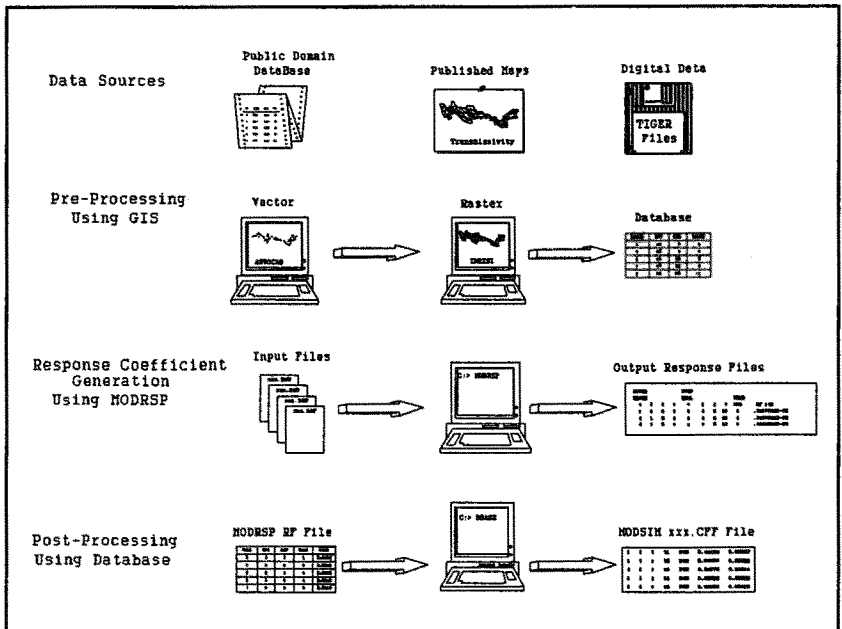

Fig 4: Using MODRSP to Create Response Coefficients

Data Preprocessing for MODRSP

GIS and DBMS procedures were used to prepare aquifer transmissivity, boundary, well, and river reach input data files used by MODRSP. Figure 5 illustrates procedures used to prepare boundary files.

Execution of MODRSP

MODRSP is written in FORTRAN programming language. Large model simulations (50,000 cells) can be run on a microcomputer by compiling MODRSP using Microsoft Fortran 5.1 and running under Microsoft Windows. Figure 6 shows the input and output files required for MODRSP. A well documented user manual is available for MODRSP (Maddock and Lacher, 1991)

Data Postprocessing for MODRSP

The coefficients output from MODRSP represent groundwater flow responses over a user defined time period at a single river grid due to the pumping of a unit discharge for a single period at a single well. These results must be summarized by river reach before they can be used in a stream-aquifer management model. This is done using database procedures.

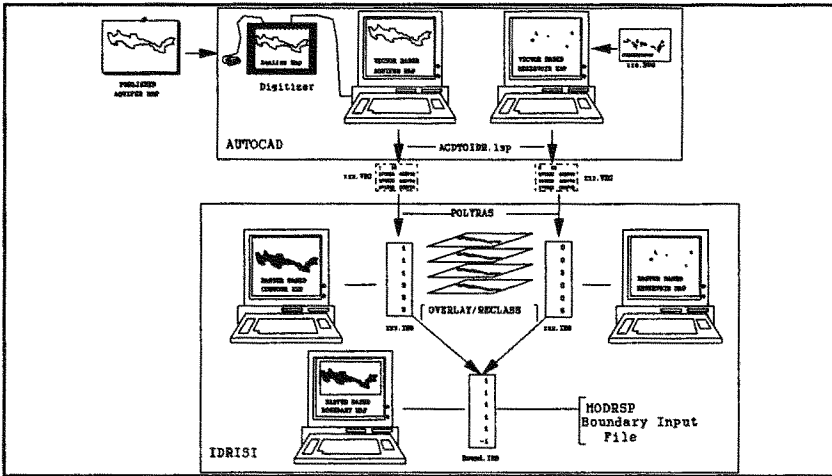

Fig 5: MODRSP Boundary File

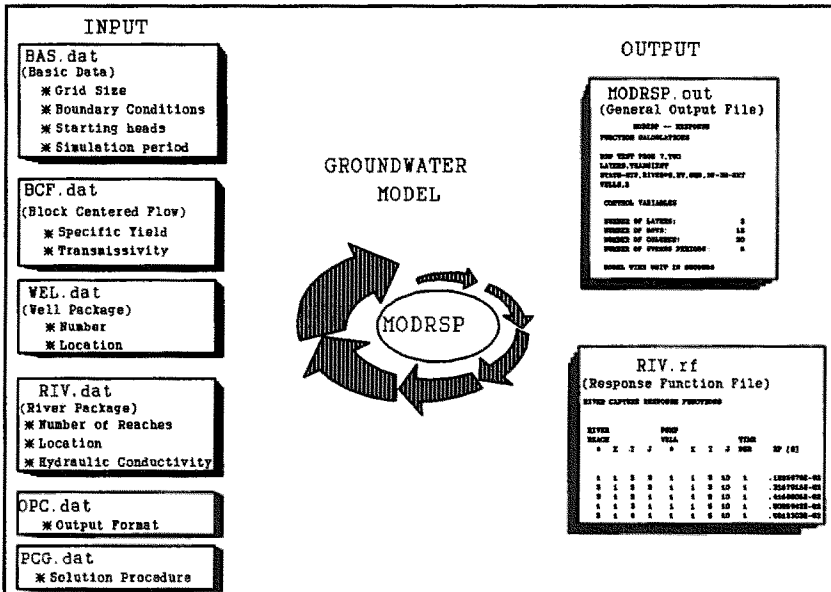

Fig 6: MODRSP

STREAM-AQUIFER MODELING USING MODSIM

MODSIM (Labadie, 1987) is an interactive river basin management model. It is a capacitated network flow model in which the components of the system are represented as nodes (reservoirs, diversion points, points of inflow, demand locations, etc.) and links having specified direction of flow and maximum capacities (canals, pipelines, river reaches). An optimization algorithm, RELAX (Bertsekas and Tseng, 1988), is used to iteratively solve the flow network problem while satisfying mass balance and maintaining link flows within required limits. Solution by the network optimization algorithm insures that available system flows are allocated according to user specified operational rules and demand priorities.

An updated version of MODSIM allows the user to model long term river basin planning activities, daily river administration, and river management options such as groundwater augmentation. MODSIM is designed to handle appropriation water right features such as decreed diversions, direct release from a reservoir to a downstream diversion point, reservoir storage accounts, diversions at alternate points, exchanges, trades, recharge, and augmentation plans.

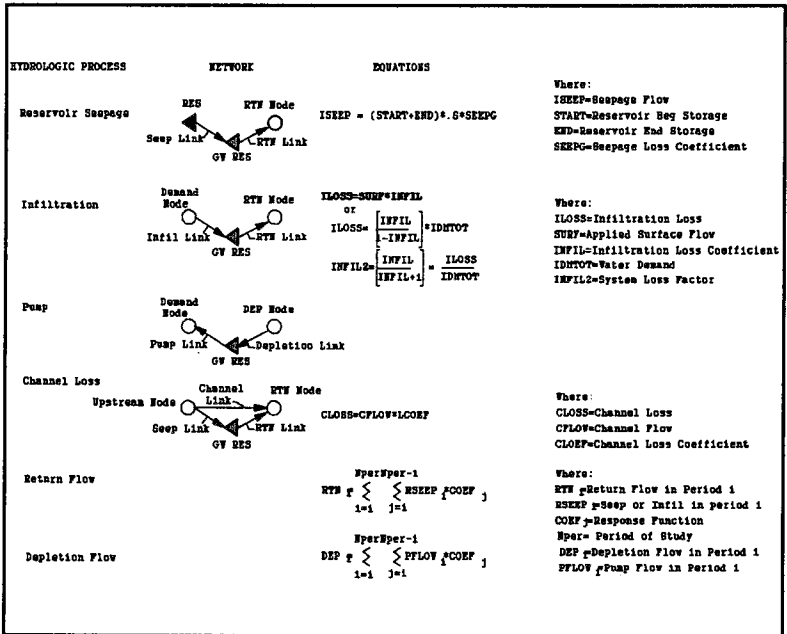

Fig 7: MODSIM Stream-Aquifer Functions

The Stream-Aquifer module within MODSIM allows the user to consider reservoir seepage, irrigation infiltration, pumping, channel losses, return flows, river depletion flows due to pumping, and aquifer storage as shown in Figure 7.

Other features which can be modeled include, overbank storage, channel routing, and divided flows. Stream-Aquifer return/depletion flows are simulated using response coefficients calculated using one dimensional equations developed by Glover (1974), McWhorter (1972), and Maasland (1959). Groundwater response coefficients estimated from other methods such as the SDF method, the 3-D groundwater finite difference model MODRSP (Maddock and Lacher, 1991), or the discrete kernel generator, GENSAM (Morel-Seytoux and Restrepo, 1987) can be read in as external data files. If spatially distributed stream-aquifer response coefficients have been generated using MODRSP they can be used to allocate groundwater return/depletion flows to multiple return/depletion flow node locations any where in the river basin network system as shown in Figure 8.

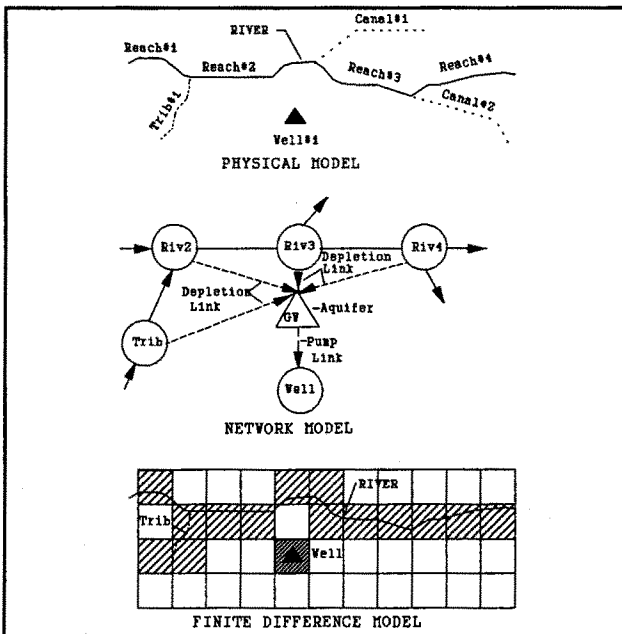

Fig 8: Stream-Aquifer Models

CASE STUDY

To demonstrate the capabilities of the DSS a reach along a 70 mile section of the Lower South Platte River, Colorado, between the Kersey and Balzac river gage stations under administrative control of State Engineer's Water District #1 was selected for study purposes. A river system network shown in Figure 9 was prepared which includes 9 reservoirs, 20 diversion points, 50 direct decree diversions, 30 storage decree diversions, and 9 recharge areas. Other network nodes were designated for exchanges, trades and alternate points of diversion. A groundwater grid network with 370 by 140 grids (1000 ft x 1000 ft cell) shown in Figure 10 was developed using GIS techniques. Spatially distributed stream-aquifer response coefficients were generated for the Bijou Irrigation Company augmentation plan (HRS 1993) which involves 200 wells and 32

recharge events. Conjunctive use management was demonstrated through monthly simulation of historical recharge and groundwater augmentation efforts for the Bijou augmentation plan. The consequences on daily river administrative of the South Platte River of various augmentation scenarios was then compared. An interactive graphical user interface was prepared for viewing the results of the study.

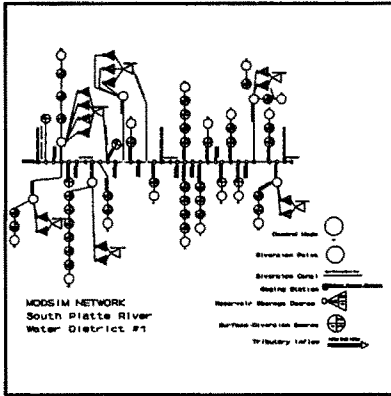

Fig 9: MODSIM Network

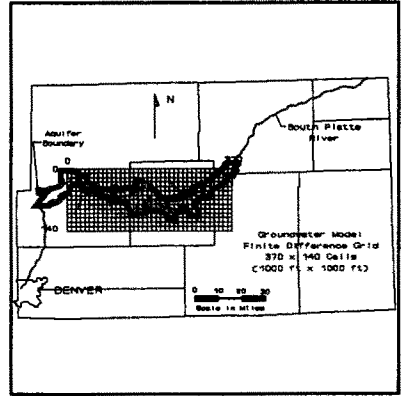

Fig 10: Finite Difference Grid

Comparison of response coefficients generated by the finite difference method and using SDF values for a single well located within the study area are shown in Figure 11. Results from the finite difference model show that 95% of the depletion flows to the well are drawn from the river and its tributaries within a 3 year period, while the SDF method accounted for only 68 % of the depletion flows during the same period. These results also show that tributary flows can provide a major source of water for well depletion and should not be ignored in the development of augmentation plans. For the well represented in this example 54 % of the depletion flow was drawn from tributary sources as shown in Figure 12.

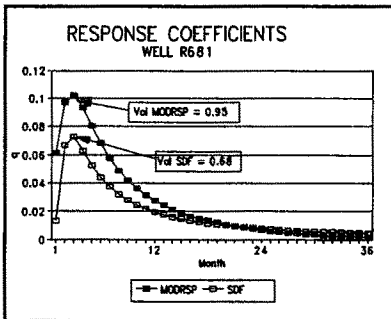

Fig 11: Comparing Response Coefficients

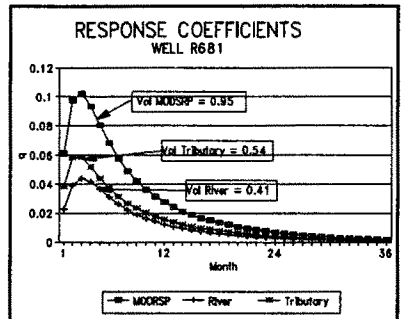

Fig 12: MODRSP Response Coefficients

CONCLUSIONS

A micro-computer based geographic information (GIS) is presented for decision support in conjunctive use of groundwater and surface water for irrigated agriculture. Spatially distributed stream-aquifer response coefficients are generated using the finite difference groundwater flow model, MODRSP, GIS and DBMS techniques. The river basin network simulation model, MODSIM, uses these coefficients to allocate return/depletion flows to any number of return/depletion flow nodes anywhere in the network. The use of MODSIM as a stream-aquifer management model was demonstrated by evaluating the effects of a major augmentation plan on daily river administration of a portion of the Lower South Platte River, Colorado.

REFERENCES

- Bertsekas, D.P. and P. Tseng. 1988. Relaxation methods for minimum cost ordinary and generalized network flow problems. *Operations Research* 36-1: 93-114.
- Bureau of the Census. 1989. TIGER/Line precensus files, 1990 Technical Documentation. U.S. Department of Commerce, Washington D.C..
- Cauffield, H.P., etal. 1987. Voluntary basinwide water management: South Platte River Basin Colorado. Completion Report No. 133. Colorado Water Resources Research Institute, Colorado State University, Ft. Collins, Colorado.
- Glover, R.E. 1978. Transient groundwater hydraulics. Water Resources Publications, Fort Collins, Colorado.
- Goutler, I.C. and D. Forest. 1987. Use of geographical information systems (GIS) in river basin management. *Water Science Technology* 19-9: 81-86.
- HRS Water Consultants, Inc. 1983. Bijou Irrigation Company plan for augmentation engineering report. Lakewood, Colorado.
- Hurr, R.T., P.A. Schneider Jr., and Others. 1972. Hydrogeologic characteristics of the valley fill aquifer in the Brighton, Greeley, Weldona, Brush, Sterling, and Julesberg Reaches of the South Platte River valley, Colorado. U.S. Geologic Survey Open File Report Prepared in Cooperation with the Colorado Water Conservation Board, Water Resources Division, Colorado District, Lakewood, Colorado.
- Jenkins, C.T. 1968. Computation of rate and volume of stream depletion by wells. *Hydrologic Analysis and Interpretation. Techniques of Water-Resources Investigations of the U.S. Geological Survey, Book 4 Chapter D1.* United States Printing Office, Washington D.C.
- Labadle, J.W., S. Phamwon, and R. Lazaro. 1983. Model for conjunctive use of surface and groundwater: Program Consim. Completion Report No. 125. Colorado Water Resources Research Institute, Colorado State University, Ft. Collins, Colorado.
- Labadle, J.W. 1987. Program Modsim: River Basin Network Flow Model for the Microcomputer. Department of Civil Engineering, Colorado State University, Ft. Collins, Colorado.
- Loucks, D.P., M.R. Taylor, and P.N. French. 1985. Interactive data management for resource planning and analysis. *Water Resources Research* 21-2: 102-113.
- Maasland, M. 1949. Water table fluctuations induced by intermittent recharge. *Journal of Geophysical Research* 64-5: 549-559.
- Maddock II, T. and L. Lacher. 1991. MODRSP: a program to calculate drawdown, velocity, storage and capture response functions for multi-aquifer systems. HWR No. 91-020. Department of Hydrology and Water Resources, University of Arizona, Tucson, Arizona.
- Maddock III, T. 1972. Algebraic technological functions from a simulation model. *Water Resources Research* 8: 100-104.

- Maddock III, T. and L. Lacher. 1991A. Drawdown, velocity, storage and capture response functions for multiaquifer systems. *Water Resources Research* 27-11: 2885-2898.
- McDonald, M.G. and A.W. Harbough. 1988. A modular three-dimensional finite difference groundwater flow model. *Modeling Techniques. Techniques of Water-Resources Investigations of the United States Geological Survey Book 6 Chapter A1. United States Printing Office, Washington D.C.*
- McWhorter, D.B. and Others. 1972. Analytical model of stream-aquifer systems with pumping and recharge. Completion Report Submitted to Colorado State Engineer's Office, Denver, CO.
- Morel-Seytoux, H.J. and J.I. Restrepo. 1987. SAMSON - Vol. I - users manual. Colorado Water Resources Research Institute, Colorado State University, Ft. Collins, Colorado.
- Moulder, J.E. and C.T. Jenkins. 1969. Analog-digital models of stream aquifer systems. *Groundwater* 7-5: 19-24.
- Pinder, G.F. 1988. An overview of groundwater modelling. *Groundwater Flow and Quality Modeling. E. Custodio et al (eds): 119-134. D. Reidel Publishing Company.*
- Schafer, J.M. 1979. An interactive river basin water management model: synthesis and application. Technical Report No. 18. Colorado Water Resources Research Institute, Colorado State University, Ft. Collins, Colorado.
- Sprague, R.H. 1980. A framework for the development of decision support systems. *MIS Quarterly* 4-4: 1-26.
- Sprague, R.H. and E.D. Carlson. 1982. Building effective decision support systems. Prentice Hall Inc.
- Taylor, O.J. and R.R. Luckey. 1972. A new technique for estimating recharge using a digital model. *Groundwater* 10-6: 22-26.
- Warner, J.W., D.K. Sunada, and A. Hartwell. 1986. Recharge as augmentation in the South Platte River basin. Technical Report No. 13. Colorado Water Resources Research Institute, Ft. Collins, Colorado.
- Wright, C.E., ed. 1980. Surface water and groundwater interaction. Studies and Reports in Hydrology. Series 29. United Nations Publication.

MAPPING TECHNOLOGY IN THE '90's FOR GIS APPLICATIONS TO IRRIGATION AND DRAINAGE

Larry J. Edwards, Ph.D.¹

ABSTRACT

Mapping technology, specifically photogrammetry and its related disciplines, has been extensively employed for irrigation and drainage engineering and management applications since becoming a practical tool in the post World War II era. The computer, space and information systems revolution of the '80's has radically changed the methods and potential for photogrammetric mapping applications. All aspects of photogrammetry have been affected including ground control surveys, aerial photography, stereo-restitution and map compilation, and cartography, the form in which maps are presented or published. The NAVSTAR Global Positioning System (GPS) satellites are used extensively to rapidly establish highly accurate ground for mapping projects. GPS is also used to improve aerial photography operations by providing an accurate flight line guidance system. Future GPS developments will permit instantaneous and highly accurate positioning of the aerial camera system at the moment of exposure. The analytical stereo plotting instrument developed and the close of the '50's is rapidly becoming the industry standard for the measurement and conversion of aerial photographs into highly precise maps and spacial data. The evolution of the personal computer and computer graphics has led to the "digital map" and the "digital terrain model" which in turn provides powerful management and analysis capabilities for geographically distributed data through the use of Geographic Information Systems (GIS).

DEVELOPMENT OF PHOTOGRAMMETRY

In order to better appreciate the dramatic changes which are taking place in the terrain information disciplines it helps to look back over the last 150 years to the beginnings of photogrammetry as a means of collecting terrain data. The first aerial photographs taken from hot air balloons in France in the late 1850's were more of a curiosity than of practical value. But within the next year Napoleon was using photos

¹General Manager, Aero-Metric Engineering, Inc.,

taken from balloons as a reconnaissance tool in preparation for battle. An just four years later an officer in the Union Army used photographs taken from a tethered hot air balloon to plot the position of enemy targets for artillery aiming.

The principals of perspective and stereoscopy which are so important in photogrammetric processes were developed and defined by an artist and an astronomer, both Germans, in the last half of the 16th century. But it was in the closing years of the 19th century that engineers and surveyors began to apply these to the photographs taken from either balloon cameras or terrestrial cameras in order to "precisely" determine positions of objects in the photos with respect to each other, and with respect to the location of the camera from which the photos had been taken, thereby giving birth to the discipline called "photogrammetry", the art and science of making reliable measurements from photography. These mathematical relationships still govern our discipline today.

Much significant work was accomplished by these early pioneers in terms of surveying and mapping, including the use of a photo theodolite, a combination of a camera and a surveying instrument, for surveys of the U.S. and Canadian boundary. In this same time period, the late 1890's and early 1900's, water related engineering projects were among the first to utilize this new discipline of photogrammetry. Reconnaissance mapping for the Lynn Canal and the Portland Canal in Alaska was prepared using a surveying camera in conjunction with a plane table.

But the invention of the aircraft was the first real breakthrough which spurred on the development of aerial photogrammetry as a mapping discipline. The first photographs known to be taken from an aircraft were taken appropriately by Wilbur Wright in 1909, with the earliest known application of aerial photos for mapping purposes being documented in 1913.

During both World War I and World War II military uses advanced the science of photogrammetry. The technological revolution which followed saw improvements in optics and the mechanical systems for stereo restitution and measurement systems making photogrammetry a practical tool available to almost everybody.

During this period almost every discipline of natural science had its group of scientists developing applications of aerial photography to that science, soils,

forestry, agriculture, geology geography and hydrology. Civil engineers began to use low level photography and stereo restitution to prepare large scale maps for engineering projects. Most major universities included some aspect of photogrammetry in their engineering, cartography or applied science curriculums and instituted significant research programs as well.

Agencies such as the Tennessee Valley Authority played significant rolls in the development of photogrammetric technology as well as application. A large photogrammetric survey of the entire Tennessee River Watershed was instituted prior World War II. Experience from this project and research by TVA lead to the first domestic production of instruments for the routine preparation of topographic maps from aerial photography. From the TVA to the extensive programs of the Bureau of Reclamation, water resource needs were a fundamental influence on the development of photogrammetry during its adolescent years.

TRADITIONAL USES OF PHOTOGRAMMETRY IN WATER RESOURCES

Before examining the changes taking place in photogrammetry in the '90's, let us review for a moment some of the traditional applications which have been made of the capabilities of photogrammetry since its acceptance as a commonplace tool for gathering and presenting terrain information.

Photogrammetry is both a qualitative and a quantitative discipline. Aerial photos can be used by themselves for the information they present about the character of the terrain. Landuse, soil and vegetation type, geology and drainage can be interpreted by knowledgeable users by what they "see" or infer from the photo evidence. Using specialized equipment photogrammetrists can make measurements in three-dimensional space of the terrain surface and the features thereon. These measurements can be converted to precision graphics, or maps. This is the quantitative aspect.

The use of photogrammetry by the Tennessee Valley Authority to map the Tennessee River watershed for planning and evaluation of the Tennessee Valley projects has already been mentioned. The USDA Soil Conservation Service has been a large consumer of photogrammetric services to acquire photography for soil and land use mapping, the qualitative aspect, and for the preparation of large scale topographic maps for drainage basin erosion, drainage and runoff control planning and de-

sign, the quantitative aspect.

The US Army Corps of Engineers has been instrumental in the development of photogrammetry since its introduction in the United States and a major user of its capabilities for their many water resource related projects. All of the navigable waterways directories and River Book maps have been compiled by a combination of photogrammetry and hydrographic survey. During the 1970's and '80's the Corps, the Federal Emergency Management Agency (FEMA) and other agencies made extensive use of photogrammetry for the floodplain delineation and mapping program. Not only was photogrammetry used to make topographic maps of the flood plains, but it was also used to compile the cross sections of the flood plain surface, which when combined with below water cross section surveys formed the basis for flood routing calculations and determination of water surface profiles.

The US Bureau of Reclamation has used the services of photogrammetry for its extensive reservoir and canal system projects. Topographic maps of varying scales are used for reservoir delineation, and dam and recreation site design, strip maps for canal design. Cross sections of the terrain compiled by photogrammetric measurement along the centerline of canals, access roads, and across borrow areas are used for earthwork computation.

The conversion of simple aerial photo images into scale rectified photomaps and orthophotos is another photogrammetric process which has extensive application in irrigation and drainage. I have previously managed a project in Haiti where rectified photomaps were required for the delineation of land use and ownership within a large agricultural delta area for the implementation of a major irrigation and drainage project for the rice and vegetable industry in the valley.

These examples indicate how photogrammetry has been used in traditional applications for water resource, irrigation and drainage applications throughout the last 40-50 years with the results being traditional photos, maps and cross sections for the most part.

PHOTOGRAMMETRY IN THE '90'S

The computer, space and information systems revolution of the '80's has had more impact on the mapping industry in a short time than any other factor in the histo-

ry of the discipline. All aspects of what we do and the way we do it are being affected. This includes the ground control surveys necessary for accurate mapping, the aerial photography, the map data compilation process, and the cartographic completion process or the manner and form in which the map data is presented.

For example, five years ago the typical large scale map prepared by photogrammetry was drafted by scribing or engraving a negative copy which was then printed onto a sheet of photosensitive mylar. Some completed maps, less than 5 percent of all produced, were delivered in some form of computer data file. Today, it is safe to say that at least 95 percent of all the mapping produced is delivered in a digital computer graphics format. Hard copies of the mapping if they are furnished at all are most likely created not by scribing or ink drafting but by computer driven pen plotters and laser film writers.

Let's now take a look at the changes which are taking place in each area of the mapping process and what that will mean in terms of the possibilities for use in irrigation and drainage applications. The way things are done in photogrammetry, and in some cases the things that can be done are going to change radically.

Ground Control Surveys

Surveying capability has progressed over the years from the compass and chain, to the transit and tape, to the theodolite and electronic distance meter, to the total station of today. A colleague of mine working in the area of developing technology for surveying said about fifteen years ago, "Some day the surveyor will be able to walk around with a brief case in his hand and make measurements automatically." He was close. Though the accuracy is still limited, there are electronic receivers about the size of a pocket transistor radio or hand held calculator which will report and record its location and that of its user in latitude and longitude or other coordinates as it is moved about over a project area.

This capability for rapid positioning is based on the Department of Defense's NAVSTAR Global Positioning System satellites, commonly called simply GPS. A single GPS receiver recording signals from four or five of the NAVSTAR satellites will give its position on the ground to an accuracy of plus or minus 100, 20 or even 10 meters. This space age technology can be envisioned in a simplified manner as a resection survey to the

unknown occupied location from the know position of the several satellites overhead at the time of the observations or measurements. Ultimately, a network of 21 satellites will give 24 hour a day capability anywhere in the world for position determination.

While the currently available precision for a single GPS receiver working alone is limited, when three or more receivers are operated simultaneously, originating on known triangulation stations, and proceeding in a systematic manner throughout a network of ground points to be surveyed, results having position accuracies in the range of 1:100,000 to 1:1,000,000 are commonplace.

Five years ago while performing GPS surveys it was necessary to place receivers on a point and to record data from the satellites for periods ranging from 30 minutes to over an hour. Now it is possible to achieve the same results in 15 to 30 minutes per point with thenew receivers just on the market within the last 6 months. These receivers and their associated data reduction and adjustment software have the capability of producing lessor orders of survey position accuracy, such as Second or Third Order, 1 part in 10,000 to 1 part in 50,000, when operated in different methods. Recently our survey crews determined the horizontal state plane coordinates of 80 points for a seven mile long project which was to be mapped at a scale of 1"=50' (1:600) within only 40 total staff hours for the crew. Also, with GPS no longer is it necessary to have line of sight visibility between the survey stations, only between the receiver and the satellite.

While GPS methods are producing extremely good results for horizontal positions, because of the geodetic survey principals which govern, the results for the vertical component or elevation are not as easily obtained nor as reliable or precise as the horizontal position component. Most surveyors are being conservative in the application of GPS for the determination of elevation for mapping control and are still using various types of differential leveling for this purpose. We have successfully applied GPS positioning to determine elevation for mapping having contour intervals of 5 feet (1.5 meters) or more. But we can expect this to improve further in the '90's.

Aerial Photography

A number of changes have taken place which improve the capability of photogrammetry as a result of improved photography. These include improved lenses on our

cameras, both in terms of resolution capability and residual image distortion caused by design limitations and manufacturing flaws. These improvements are a direct result of computer aided design and computer aided manufacturing. Films are being produced with greater resolution capability than ever before.

But there are several major changes in the overall camera systems which are having profound effects on the capability of photogrammetry and the methods of operation. One which is relatively common in most recently manufactured camera systems is called Forward Motion Compensation or simply FMC. FMC causes the film to move in the camera, while the shutter is open for the $1/100$ or $1/200$ of a second, at a velocity in the film plane which is exactly relative to the speed of the aircraft over the ground. This eliminates the blurring of the photo image caused by the motion which has been inherent in aerial photography since inception.

Another recent development is a practical and operationally satisfactory gyro stabilized camera mount. Because of turbulence it is impossible to fly a photo aircraft straight and level at all times. Gyro stabilized mounts have been tried by the military as far back as the '60's, but until the last year satisfactory commercial models have not been available. The less tip or tilt present in a photo the less compensation is required for geometric distortion in the mapping instruments, and the better the map which can result.

But technology is on the verge of a two major breakthroughs for aerial photography and the mapping process. The GPS positioning system is the basis for one aspect of change in aerial photography and subsequent mapping. At present GPS receivers installed in aircraft are capable of providing precision airborne navigation and flight guidance along predetermined flight lines. This will be of major consequence when aerial photography is required over large undeveloped areas and in third world areas where existing maps are not adequate to enable precision visual navigation.

Low level photography was required over the rice paddies in the river delta in Haiti which I mentioned previously. It was impossible to rely on visual navigation because all of the land looked the same from the air at 150 miles an hour. The solution to the flight line location was to place tall guyed poles on the ends of each flight line with large colored flags which could be visible to the flight crew. A similar technique, placing large arrows made of plastic strips at the

ends of the proposed flight lines, has been used by our crews for projects in the relatively featureless range land of the high plains region of Colorado. With GPS navigation exact flight line tracking can be achieved in situations like these by simply inputting the latitude and longitude of the flightline endpoints.

In a further application along the same direction, research is actively underway using GPS systems to record the precise position of the camera in the aircraft at the moment of exposure. For this purpose ground GPS receivers located at known control points record satellite data at the same time as the receiver in the aircraft coupled to the shutter of the camera. The coordinates of the camera position in three dimensional space can be determine fairly precisely, as with GPS surveys for the determination of ground control points. Research has demonstrated the technical feasibility to conduct photogrammetric mapping from aerial photography obtained in this manner with little or no ground control, but refinements are required to the GPS receiver antenna design for operational considerations and to the software and the technique before accuracies will be sufficient for practical application (Erlandson etal, 1991).

Over the years photogrammetrists have generally classified the imagery obtained from the air recorded directly on film through a camera lens as "photography", and that which is recorded on some sort of magnetic media by some type of electronic sensor as "remotely sensed data". Technology has now advanced to the stage that the possibility of recording an array of digital data in the form of pixels (picture elements) on a digital memory chip instead of a piece of photosensitive film is not only feasible but a reality. Recently my wife and I had our picture taken for our church directory, and a moment afterward viewed the photo on a high resolution computer terminal. As with the GPS positioning, only refinements are needed before this will become a practical method of "photography" for photogrammetric applications.

Photogrammetric Measurements and Restitution

Computers, scanners, digital computer graphics systems as they have developed in the '80's have changed the way we are now converting photos to maps. The projection and optical mechanical stereoplotters which have been the mainstay of the mapping equipment for the last 40-50 years have been almost completely replaced by computer controlled instruments. Instead of the stereo

image of the photographs being optically and mechanically projected into a plane of reference for measurement, the spacial orientation and relational measurement of the two photos forming a 3-dimensional stereoscopic view are performed analytically hundreds of times each minute on a continuous basis as the operator views the photos and moves about in the view. At Aerofetric Engineering for example, twenty out of our twenty-eight instruments are of the analytical type, whereas only three years ago the ratio was the opposite. The analytical stereoplotters provide many refinements and options in the mapping process. For example, the effects of imperfections in the camera lens can be programmed into the plotter which will then be removed analytically and differentially as the operator maps from different portions of the photo. Likewise the radial displacement effects of atmospheric refraction can be eliminated, as can the warping effects of earth curvature. The computer can remember the orientation parameters for each photo which has been set up and used for mapping. If the operator needs to reset a model, all that is necessary is to enter the photo identification number.

More significant however for some water resource applications is the capability of being able to program the instrument to cause the operator to take measurements of the ground surface at finite locations. This is particularly advantageous for the collection of profiles across floodplains for flood flow calculations. Given the location of the endpoints and deflection points along the desired cross sections, when input into the analytical instrument's computer, the operator's field of view will be moved precisely along the line connecting the ends and deflection points so that the elevation and distance along the line can be measured and recorded in the system's computer.

In a similar manner the instrument operator can program the system to "drive" him to finite spaced grid value locations in order to measure a grid elevation model, or along evenly spaced profiles for a terrain profile model.

The most significant change in the last five years is the transition from the mechanically drawn map manuscript and manual drafting to computer-aided drafting (CAD) systems. The affordability of fast, powerful personal computers and workstations, and the availability and widespread implementation of user-friendly CAD systems, such as Intergraph's MicroStation, and Autodesk's AutoCad, has allowed the photogrammetrist to use

digital computer graphics to create the maps of the '90's.

The use of these CAD systems, analytically compiled terrain data, and the advent of high resolution photo scanning instruments has also made possible the digital orthophoto. Many of you may have used orthophotos as a map base in your irrigation and drainage projects because of the advantages they offer, showing the photo image of the ground in an exact scale representation, with superimposed reference grid, and perhaps also the contours or other information. These orthophotos can now be prepared analytically and presented in digital image format for use with CAD systems.

GEOGRAPHIC INFORMATION SYSTEMS AND MAPPING

There is quite possible not a single scientist or engineer working in the areas of resource applications and management that has not heard of geographic information systems or GIS. What is a GIS? It is quite simply an assemblage of computer hardware and software which provides for the management of information which is geographically distributed in its nature through the use of digital computer data bases related to digital computer graphics. Some GIS systems provide capability to do relational queries, perform relational analyses and create complex reports and maps from different types of data stored in the data bases.

For example the two papers preceding this one on the program dealt with GIS applications, and imagery or mapping (Podmore and Wagner, 1992; Fredericks and Labadie, 1992). During another conference this last summer three papers dealt with GIS applications in hydrology (Shamsi, 1992; Vieux, 1992; Jones and Nelson, 1992).

GIS is becoming a powerful tool enabling questions to be asked and answers to be created which were not previously possible. The state of the art capability in photogrammetry is able to provide the digital maps and digital terrain data which are fundamental to a GIS.

Photogrammetry in the '90's is able to provide maps and map data in forms and formats not previously available. Concepts such as map scale and accuracy no longer have the same meaning in CAD or GIS systems as they previously had with hard copy maps. CAD systems allow the user to change scale upon desire. Therefore, it is more important to be concerned with positional accuracy

f mapped data, level of detail and content rather than map scale for CAD and GIS applications. Knowing the accuracy requirements and intended use the professional photogrammetrist can design the mapping process to meet the specific GIS users needs.

In the past it has been usual to think of the presentation of terrain data in the form of a topographic map with the surface configuration and relief depicted by contours at some preselected interval. In computer-aided design and GIS systems contours are no longer necessarily needed, nor are they necessarily the best way to express topography for analysis and modelling. Consequently, the photogrammetrist is doing less and less "contouring", and more and more terrain modelling. Instead of mapping points of equal elevation along a line, the technicians may compile randomly distributed spot elevations which depict the land surface, called mass points, with three-dimensional line strings along discontinuities such as crests, breaks in slope and the axis of drainages, called break lines. These terrain models can be used to model drainage and irrigation canals, or floodplains for flow analysis (Vieux, 1992; Jones and Nelson, 1992), and can be used to model reservoirs for the calculation of stage storage tables.

Mapping technology in the '90's is able to provide more data and different types of data than ever before. It is the primary source of the geographic base map for GIS systems. Much of the data needed for irrigation and drainage systems design and management can be provided through photogrammetry more effectively to meet the water resource challenges of the '90's.

REFERENCES

- Erlandson, John P., Kenneth D. Graybeal and Allan Yonker. 1991. GPS-controlled photogrammetry demonstration project. Proceedings of the 1991 Surveying Conference, US Army Corps of Engineers, US Army Engineer Topographic Laboratories, Fort Belvoir, VA.
- Fredericks, Jeffrey W. and John W. Labadie. 1992. GIS and conjunctive uses for irrigated agriculture. Proceedings of the 1992 National Conference on Irrigation and Water Resources in the 1990's. U.S. Committee on Irrigation and Drainage, Denver, CO.
- Jones, Norman L. and James Nelson. 1992. Drainage analysis using triangulated irregular networks. Proceedings of the Eighth National Conference on Computing

in Civil Engineering. American Society of Civil Engineers, New York, NY.

4. Podmore, Terence H. and David G. Wagner. 1992. Determination of irrigated crop consumptive water use by remote sensing and GIS techniques for river basins. Proceedings of the 1992 National Conference on Irrigation and Water Resources in the 1990's. U.S. Committee on Irrigation and Drainage, Denver, CO.

5. Shamsi, Uzair M. 1992. GIS, remote sensing and master water plan: a case study. Proceedings of the Eighth National Conference on Computing in Civil Engineering. American Society of Civil Engineers, New York, NY.

6. Vieux, Baxter E. 1992. Finite element modeling of storm water runoff using grass: GIS. Proceedings of the Eighth National Conference on Computing in Civil Engineering. American Society of Civil Engineers, New York, NY.

THE USE OF SATELLITE DATA RELAY BY THE U.S. GEOLOGICAL SURVEY
FOR NEAR REAL-TIME HYDROLOGIC DATA COLLECTION

William G. Shope, Jr.

ABSTRACT

The U.S. Geological Survey maintains the basic hydrologic data-collection network for the United States. The Geological Survey is upgrading the network with computer-based communications to acquire, telemeter, process, and disseminate hydrologic data in near real-time. These upgrades include satellite data relay through the Geostationary Operational Environmental Satellite (GOES), data-collection platforms at more than 3,500 Survey gaging stations, six direct-readout ground stations, and a network of minicomputers that allows data to be processed and disseminated in near real-time. Satellite data relay provides valuable information to the water-user community on a timely basis for flood warning, irrigation control, reservoir management, and water-quality monitoring. Data relay also helps improve the operation of the data-collection network, which enhances the availability and quality of the hydrologic data. This paper describes the Survey's use of GOES for data relay, and the steps underway to upgrade telemetry equipment deployed and data processing procedures utilized for near real-time data collection beginning in 1976.

INTRODUCTION

The U.S. Geological Survey operates the hydrologic data-collection program that provides an information base to a wide variety of water-resources planning and management activities in the United States. The data-collection program and information base are in transition to more automated technologies that will speed the flow and analysis of data from thousands of remote data-collection stations to user facilities. This transition includes upgrades to data-collection and recording equipment at hydrologic stations, telemetry systems for automated data retrieval and networks of computers to analyze and distribute the data to users across the Nation. National economic growth over the past 30 years has been accompanied by an increase in the number of hydrologic data users who issue river forecasts, operate irrigation systems, navigational waterways, and hydro-power generating plants, and who manage reservoirs for flood-damage prevention, water supply, and recreation. These

* Hydrologist, U.S. Geological Survey, Reston, Virginia

requirements result in the need for more hydrologic data on a more timely basis, which requires that data be collected and delivered to users through automated telemetry and computerized data processing and distribution systems. This paper describes the U.S. Geological Survey's use of satellite telemetry and computers for the collection and processing of near real-time hydrologic data.

U.S. GEOLOGICAL SURVEY HYDROLOGIC DATA-COLLECTION NETWORKS

In fiscal year 1991, the U.S. Geological Survey collected hydrologic data from about 11,600 surface-water stage and discharge stations, 33,400 wells where water level and(or) pumpage data are collected annually or more frequently, and 3,300 surface-water stations and 8,600 wells where water-quality data are collected. Data from most of these stations are collected during onsite visits by U.S. Geological Survey personnel or observers who collect water samples and(or) make hydrologic measurements. Where continuous data records are needed, data are collected by use of automated recorders and/or telemetry units supplemented by manual measurements that are used for calibration and correction. The U.S. Geological Survey computes continuous discharge from stage (water-level) data records collected at 7,300 stream sites. Continuous water-level data records also are collected at 800 lakes and reservoirs, and about 2,400 wells throughout the Nation. Continuous water-quality data are obtained from 650 surface-water stations.

Many of the cooperative data-collection programs that the U.S. Geological Survey conducts with more than 1,000 Federal, State, and local government agencies, support operation of the 7300 automated hydrologic data-collection stream-gaging stations. The U.S. Geological Survey normally constructs the stations, installs and operates the sensors and recorders, makes periodic measurements to determine the relationship between streamflow and stage, retrieves and processes the stage data to compute instantaneous and mean discharges, and publishes the daily mean-discharge values. For more information on the Water-Data Program of the Survey, the reader is directed to a report by Condes (1991).

TELEMETRY OF HYDROLOGIC DATA

The procedures for acquiring data from the hydrologic data-collection sites and manually entering the data into a computer are manpower intensive and time consuming. These two factors are obstacles to providing more data on a timely basis. The U.S. Geological Survey is expediting the process through the use of new automation and data-telemetry technologies. The methods for automating the collection of data for continuous record

tations have evolved over the last 40 years from spring or weight-driven mechanical devices to electronic instruments that use new communication and computer technologies.

The telemetry of data from remote data-collection sites is being accomplished by a variety of methods. The major components of a telemetry system are: the sensors that measure stream stage, encoders that convert the sensor output to forms suitable for transmission, a transmission system that provides the link from a remotely-operated sensor to another location, and a data reception and distribution facility that receives, sorts, decodes, checks, and distributes the data. The component that characterizes the communications system is the transmission media. Conventional telemetry methods applied over the past 15 years include land lines (telephone) and high-frequency and ultrahigh-frequency (microwave line-of-sight) radios. Extraterrestrial methods applied within the past 17 years include meteorburst and satellite data-collection systems. The reader is referred to a report by Halliday (1979), for more information regarding telemetry systems.

U.S. Geological Survey Use of Telemetry

For many years the U.S. Geological Survey has provided space in some of its gaging stations for equipment that uses line-of-sight radio networks or landline telephone systems to transmit data for the water-management requirements of other agencies. Although the data collected by these traditional telemetry systems are extremely useful for the intended purposes, they lack the content the Survey requires for computing continuous stage and discharge records. For this reason, prior to the mid 1970's, the Survey did not actively utilize the available remote-telemetry systems except in source specific local applications. The value of real-time data collection to the Survey was changed with the use of satellites to relay data from remote sites. Satellite relay not only provides the water-data user with the timely data, but also provides the Survey with an opportunity to automate its data-collection activities and to monitor remotely the condition of on-site instrumentation.

The Geological Survey does not require telemetry to fulfill its basic internal mission to collect, interpret, report, and archive environmental data. The Survey does not impose time-limits on its data reports that require real-time data. The additional operating costs (\$1500-\$2000 per year, per station) on top of the cost of data relay equipment (\$3500-\$5000 per station), limits the Survey's ability to install and operate telemetry at its data-collection stations. The Survey's involvement with telemetry is driven primarily by the requirements of other Federal, State, and local agencies need for real-time hydrologic information from data-collection stations operated by the Survey. The cost for the Survey to install and operate

telemetry at these stations is, in most cases, paid for by the action agencies that require real-time data for flood forecasting, irrigation control, reservoir management, and water-quality monitoring. In many cases, real-time data are acquired by the action agencies through their own data telemetry reception facilities.

The Survey considers real-time data received from its data-collection stations to be provisional, unedited data subject to revision and thus not available for general release. The Survey does not consider data transmitted in real-time to be an end product; however, such data, when appropriately decoded, edited, interpreted, and quality-controlled, provide an excellent opportunity to improve the Survey's data-collection operations, the quality of hydrologic information, and timelines for data availability. These benefits are significant to the Survey, but are considered secondary to the benefits derived by the action agencies in accomplishing their missions.

Telemetry Selection

The evaluations conducted by the Survey and many other Federal agencies have shown that satellite telemetry, when compared with other telemetry systems, is generally cost-effective, reliable, easy to install and operate, able to cover vast areas, and extremely flexible in carrying a wide variety of data transmissions that can be scheduled to meet user needs. For reasons of compatibility with other federal agencies, economics, flexibility, and large area coverage, the Survey has chosen to use the Geostationary Operational Environmental Satellite (GOES) Data Collection System (DCS) operated by the National Earth Satellite, Data, and Information Service (NESDIS). The GOES-DCS is provided at no cost to the Survey and other Federal, State, and local government agencies under a Memorandum of Agreement with NESDIS, which is a component of the National Oceanic and Atmospheric Administration. This agreement specifies NESDIS as the operator of the satellites, the primary ground receiving station, and a data-distribution center. The reader is referred to National Oceanic and Atmospheric Administration (1979) for detailed information on the GOES DCS.

GOES Data Collection System

The GOES data-collection system uses Earth-orbiting satellites to relay transmissions from networks of data-collection sites to one or more receiving stations. A satellite data-collection system is made up of data sensors linked to small radios called data-collection platforms (DCPs) that transmit data to satellites which immediately relay the data to Earth receiving stations that forward the data to data handling and distribution facilities.

The commercially available GOES DCPs can satisfy most needs for collecting and reporting hydrologic data. Users define the rates at which DCP's collect and temporarily store data from sensors and subsequently transmit these data to the GOES satellite. Data collection from the sensors may be programmed to take place at 15-, 30-, or 60-minute intervals, and the DCP transmissions normally are scheduled by the users at 4-hour intervals. These self-timed transmissions consist of messages that contain, at a minimum, all data collected from the sensors since the last transmission. In some cases, the messages are extended to include data from one or more previous transmissions, thus providing redundancy in data transmission. Most of these DCP's also contain an alert feature that triggers unscheduled data transmissions within several minutes of the detection of a data value that has exceeded a user-defined threshold or differential when compared with the previous sensor value. An example of this is a rapid change of stream stage or rate of precipitation during a critical hydrologic event. Alert messages normally contain the most recent set of values collected. DCPs developed in the late 1980's and early 1990's costing approximately \$3,000, have significantly increased capabilities over older models. These DCP's can provide on-site data conversion, statistical summaries, and do other analytical tasks. Messages transmitted from the DCPs are received by GOES and immediately relayed through retransmission back to Earth. Data are received from GOES by the NESDIS primary satellite ground receive station at Wallops, Virginia, as well as user-owned and operated stations referred to as a Direct-Readout Ground Station (DRGS). The Wallops station is used by NESDIS as the centralized facility for all data reception and for monitoring, command, and control of the GOES spacecrafts.

Major users of the GOES system have turned to local passive (receive only) DRGS' in an effort to reduce system complexity, increase timeliness of the data, and reduce dependence on land lines. These DRGS', which cost \$40,000-\$100,000, provide a user immediate access to the data relayed from GOES. The DRGS comprises an antenna, radio receiver, decoding equipment, and a minicomputer that functions as a system controller. This controller is powerful enough to manage the operation of the radio receiver, decode the DCP messages, flag and disseminate alert messages, store the decoded data in a temporary file, monitor the performance of the DCP transmissions, provide access for multiple users, and forward data to other computers collocated at the users offices.

During the early 1980's, the U.S. Geological Survey began to process and install satellite DRGS'. The U.S. Geological Survey currently is operating DRGS' at Harrisburg, Pennsylvania; Columbia, South Carolina; Denver, Colorado; San Juan, Puerto Rico; Fort Worth, Texas; and Tacoma, Washington. For additional

information on the development of a distributive system for satellite telemetry see Shope and Paulson (1983).

The five major components of the U.S. Geological Survey's satellite telemetry system are shown in Figure 1. Surface-water level data are collected at a continuous-record station and relayed via the GOES satellite to a user-operated DRGS. Data are acquired continuously from the DRGS by one of the Survey's primary computers located near the DRGS, entered onto the Survey's telecommunications network (Distributed Information System), and delivered to the offices that operate the data-collection stations. The telemetry system, when operating properly, can automatically deliver data messages to the office in a matter of hours (minutes for alerts).

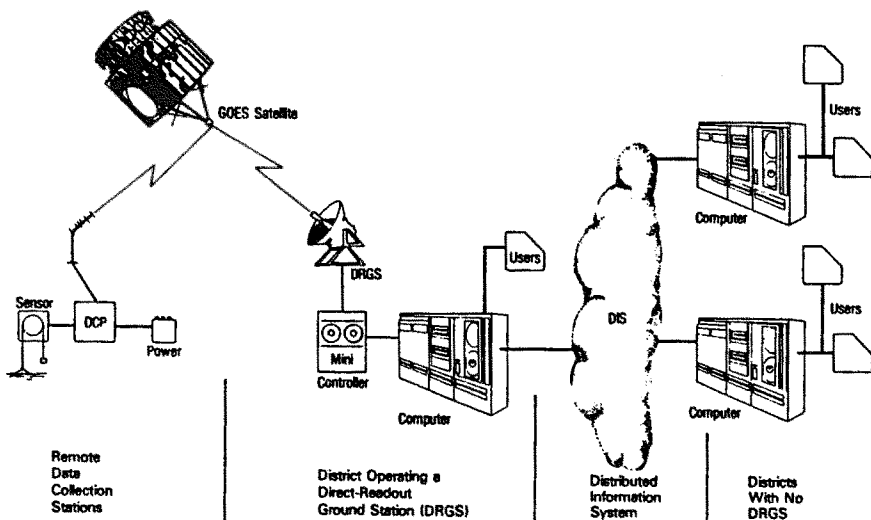

Fig. 1. -- Hydrologic data collection by use of satellite telemetry and a Distributed Information System

Advances in Telemetry of Hydrologic Data

The Survey is in the process of upgrading its telemetry system to provide greater capacity, better reliability, and lower operating and maintenance costs. The first step in this upgrade is to replace the DRGS's. The DRGS's have limited receiving capability in both signal acquisition and numbers of DCP's that can be supported. The Survey has to increase the numbers of DRGS's or find an alternative, given the increasing number of

CP's and the need to improve reliability. The cost of purchasing, operating, and maintaining additional DRGS's has deferred expansion.

The Survey has evaluated several alternatives to replace the DRGS and has selected a new data distribution service supported by NESDIS. NESDIS, with interagency funding, contracted in fiscal year 1990, for a commercial Domestic Communications satellite (DOMSAT) broadcast service. Real-time data users will be able to obtain messages broadcast from the DOMSAT through the use of low-cost (\$18,000-\$22,000) Local-Readout Ground Stations (LRGS). A diagram of the data flow from the DCP's to the user data processing facility is shown in figure 2. DCP's attached to sensors acquire data and make periodic transmissions to GOES. These messages are relayed to the NESDIS Command and Data Acquisition Facility at Wallops Island, Virginia. The NESDIS Data Acquisition and Processing System (DAPS) provides time tags to the DCP messages, appends transmission performance indicators and provides the message to a DOMSAT uplink radio transmitter. DOMSAT receives the messages and retransmits the data for acquisition by receive stations (LRGS). Receive stations are connected directly to the users processing facility. A dedicated DRGS data quality monitoring station (DQM) is operated by NESDIS at Wallops to insure proper operation of the DOMSAT link.

A prototype LRGS provided under the DOMSAT contract, has been under evaluation at the Survey facilities located at the Denver Federal Center in Lakewood, Colorado, since January 1991. The contract awarded by NESDIS provides 9 years of DOMSAT service and also provides two LRGS', one to the Survey to serve as a prototype and the DQM unit at Wallops, Virginia, for monitoring DOMSAT performance.

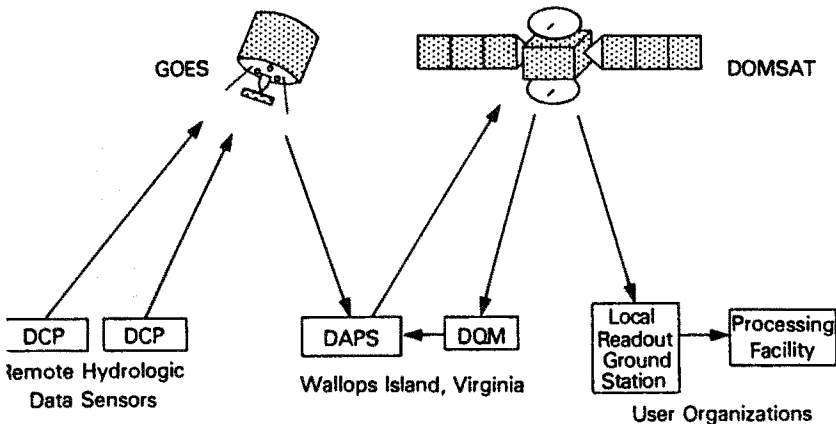

Fig. 2 -- Data flow diagram: DCP to processing

The LRGS' and DRGS' do not transmit to the satellite, monitor its health, command it and its sensors, or copy imagery; therefore, they can be dedicated to serve the single requirement of collection of real-time telemetered environmental data. Because the LRGS and DRGS can be colocated with the user or data collection network field manager, the number of communication links have been reduced, control of real-time data-collection operations has been given to the field manager, and responsiveness to user needs has been improved. As a result of these and other factors, LRGS' and DRGS' have become increasingly beneficial to users of the GOES telemetry system.

COMPUTER PROCESSING

The upgrades in real-time data collection coincide with, and are being coordinated with and linked to, the Survey's procurement of a new generation of office computers (workstations), and development of new computer software. The new computers are the second version of the Survey's Distributed Information System (DIS-II). DIS II (Harbaugh, 1986) includes the computer hardware and software supplied by the vendor such as the operating system. The software under development for hydrologic data editing, storage, computation, analysis, and reports processing is the second version of the National Water Information System (NWIS). The NWIS (Edwards and Putnam, 1987) software and databases will operate on the DIS-II computers.

The data collection and computer systems discussed in this paper cover a series of operations that begins with the automated measurement and collection of data in the field and ends with the entry of the data into the NWIS II databases. Most of the data entered into these databases result from laboratory analysis of field samples, field measurements, and data manually retrieved from automated data-loggers. Real-time data telemetered to Survey offices comprise a small but growing share of the data entering NWIS databases.

Data carried or telemetered to the central office are entered into the computers, converted to a standard NWIS input format, and entered into the Automated Data Processing System (ADAPS). ADAPS (Dempster, 1990) is a component of the NWIS used for processing and storing data collected from automated continuous-recording field instruments. The control and data-handling functions for the steps outlined above are carried out by a variety of microprocessors, computers, and specialized computer software. The following sections are devoted to presenting a more detailed summary of the new computer software that supports the hydrologic data-collection processes.

Data Conversion

Entry of data from field instrumentation into the NWIS data bases presents a major problem due to the lack of a complete set of standards in one of the critical steps in the data transfer process. Data transfer from sensors to DCP's and then to the telemetry system is supported by standards. Electrical (RS-232) and coding (ASCII) standards help support the data transfer; however, no standards exist for format, organization, and content of the files that are output from DCP's. The manufacturers of DCP's determine the format for data records stored in the field. None of these formats are compatible with the data input requirements for NWIS. This lack of standards for DCP record formats is being resolved by the Survey through the establishment of a standard input format for the NWIS ADAPS database and the development of an extensive software package termed the Device Conversion and Data Entry System (DECODES). The role of DECODES is depicted in figure 3, as are the data acquisition system (sensor/DCP), personal field computer, the instrument scripts (commands) and configuration library, and the NWIS ADAPS database. The personal field computer (PFC) is carried by the field technician and is used to program the DCP (using scripted commands) and acquire data from the DCP computer memory when the unit is used as an on-site logger. DECODES has been developed to act as the general-purpose data record or file format converter. DECODES will accept data files from a variety of

INSTRUMENT CONTROL/DATA HANDLING SYSTEM

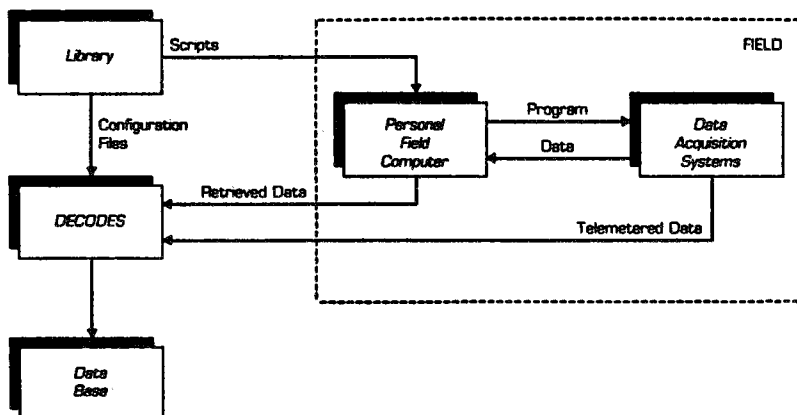

Fig. 3 -- Instrument Control and Data-Handling System

sources, and with the aid of a user-furnished configuration file that describe the input data file, convert it to the format that is accepted by ADAPS.

Prior to the development of DECODES, DCP messages were converted to an ADAPS-acceptable format in the DRGS using vendor-supplied proprietary software. The Survey's replacement of the DRGS's with LRGS's moves the DCP message conversion function to the district data processing computers. DECODES operating on these computers supports ADAPS input for data from DCP's and electronic data loggers (EDL's). Data from EDL's are retrieved manually by a field technician and DCP data are retrieved through an automated telecommunications system.

DECODES can convert both fixed and variable-interval data from most DCP's and EDL's as long as the recorder can produce ASCII data files and identify any format changes unambiguously; if the data format changes, some code must be present to identify to DECODES that the format has changed. DECODES converts data from all DCP's in use by the Survey, whether recorded in ASCII or binary format. DECODES is written in the C programming language and has been designed to operate under several computer operating systems. DECODES maintains a database of configuration information to support the conversion process. In addition, DECODES includes an option to upload data from either a PFC, laptop, or hand-held computer.

Data Processing

DECODES converts input files to the standard NWIS entry format and will place the records into an output file for processing by NWIS computer software procedures. A standard ADAPS entry procedure (SENTRY) will periodically access the output files and will, for DCP records, automatically institute screening, computation, and database entry routines. The process will be user-initiated for files entered from EDL's through the PFC. The processing of river-stage values collected by a DCP is used in the following text as an example of the processing steps in ADAPS. Stage values can automatically be screened for errors and flagged. The stage values are then converted to unit stream-discharge values, using a rating table with manually-supplied shift and datum corrections. The unit values are placed into the ADAPS database and daily mean values of discharge are computed and stored if there are sufficient unit values. ADAPS also stores, temporarily, instrument performance data as well as environmental data. The performance data can be monitored by the use of graphics software, the Automated Instrumentation Monitoring System (AIMS), or various application computer programs written by personnel of Survey District offices. The AIMS computer programs produce summary performance and exception reports that can be used to identify instrumentation problems.

SUMMARY

The U.S. Geological Survey collects hydrologic data from many streams, rivers, lakes, reservoirs, and ground-water wells throughout the United States and Puerto Rico. As a part of the data collection effort, the Survey supports a nationwide telemetry network to assist those Federal, State, and local government agencies that require near real-time data. The availability of near real-time data is important for river forecasting, irrigation control, and reservoir management, and provides many benefits to the Survey in operating its data-collection network. Conventional telemetry using telephone and land-based radio has been in use for many years, but the advent of satellite data relay capabilities in the 1970's permitted the Survey to develop a national system in cooperation with the satellite operator, NESDIS, and those agencies that depend on the Survey for hydrologic data collection.

The Survey has developed an automated system that includes automated battery-operated DCP's connected to sensors that periodically measure various types of hydrologic data such as river stage, temperature, and lake levels. These data are transmitted from more than 3500 remote stations to GOES at 4-hour intervals. GOES retransmits the data messages to the earth where the messages are received by NESDIS and user-operated DRGS's. Data are automatically forwarded to the Survey's office computers where the messages are converted to a standard format and entered into the NWIS for records processing, database storage, and data retrieval. When the telemetry system is operating properly, the data collection process from measurement (sensors) to records processing and database storage is carried out in a matter of hours (minutes for alerts) without human intervention. The Survey is upgrading the telemetry network by replacing its DRGS's with a DOMSAT link between LRGS's located at district offices and the NESDIS GOES data-collection system control station at Wallops, Virginia. Coupled with this effort, is the utilization of the Survey's new network of computer workstations, and the development of software (DECODES) that standardize the conversion and entry of DCP messages into the Survey's data processing system.

REFERENCES

- Dempster, G. R., Jr., 1990, NWIS National Water Information System User's Manual: U.S. Geological Survey Open-File Report 90-116, Volume 2, Chapter 3, Automated Processing System.
- Condes de la Torre, A., 1991, Operation of Hydrologic Data-Collection Stations by the U.S. Geological Survey in 1991: U.S. Geological Survey Open-File Report 91-172, 52 p.

Edwards, M. D., and Putnam, A. L. 1987, Conceptual Design for the National Water Information System: U.S. Geological Survey Bulletin 1792.

Halliday, Robert, 1979, The Use of Satellites in Hydrometry. Hydrometry: Principles and Practices, John Wiley and Sons, Inc., New York, N.Y.: 427-447.

Harbaugh, A. W. 1986, Water Fact Sheet, U.S. Geological Survey, Department of the Interior Distributed Information System: U.S. Geological Survey Open-File Report 85-649: 2 p.

National Oceanic & Atmospheric Administration, 1979, Geostationary Operational Environmental Satellite/Data Collection System: National Oceanic and Atmospheric Administration Technical Report NESS 78, Washington, D.C., 80 p.

Shope, W. G., Jr., and R. W. Paulson, 1983, Development of a distributive system for handling real-time hydrologic data collected by the U.S. Geological Survey: Proceedings, 1983 Hydrological Applications of Remote Sensing and Remote Transmission, Hamburg Symp., International Association of Hydrological Sciences Publ. no. 145.

REACHING TO THE SKY: CLOUD SEEDING FOR WATER SUPPLY

by

Maurice Roos¹

ABSTRACT

Cloud seeding to increase precipitation has been widely practiced in California for many years. Silver iodide is the commonly used seeding agent. The theory of how artificial ice nuclei augment natural precipitation by increasing the conversion of cloud water into snow or rain is fairly well understood. For certain orographic situations liquid propane appears to be a superior seeding agent. The California Department of Water Resources is conducting an experimental demonstration program in the northern Sierra Nevada using liquid propane as a seeding agent. The experimental program is described with some commentary on the first year of operation and the societal concerns of people in the target area about the project.

INTRODUCTION

Cloud seeding for water supply is a relatively new technology. It had its infancy in 1946 when important discoveries at the General Electric Research Laboratories in Schenectady, New York, led to practical methods of modifying large volumes of cloud at reasonable cost. The technology is still developing.

Purposes of weather modification can include clearing fog or stratus clouds, suppressing hail, or reducing lightning and wind, but most cloud seeding projects are intended to provide additional precipitation in the form of rain or snow. Some of the longer running projects in California have been underway for about 40 years - since early 1951 for the Southern California Edison Company Upper San Joaquin River project, since January 1955 on the Kings River (except for a gap from 1981 to 1987), and since 1954 in the Lake Almanor

¹Chief Hydrologist, California Department of Water Resources, 1416 - 9th Street, P. O. Box 942836, Sacramento, CA 94236-0001

drainage of the upper Feather River area. On the coast, some seeding has occurred in Santa Barbara County on and off since December 1950.

The difficulty of statistically proving results in something so highly variable as natural precipitation cooled initial enthusiasm for cloud seeding programs. During the 1970s and 1980s, some ten to twelve cloud seeding projects continued to run in California. The number tended to rise during dry periods as might be expected. During the past two water years 20 cloud seeding projects were operating in California. The 1991-92 project locations are sketched on Figure 1.

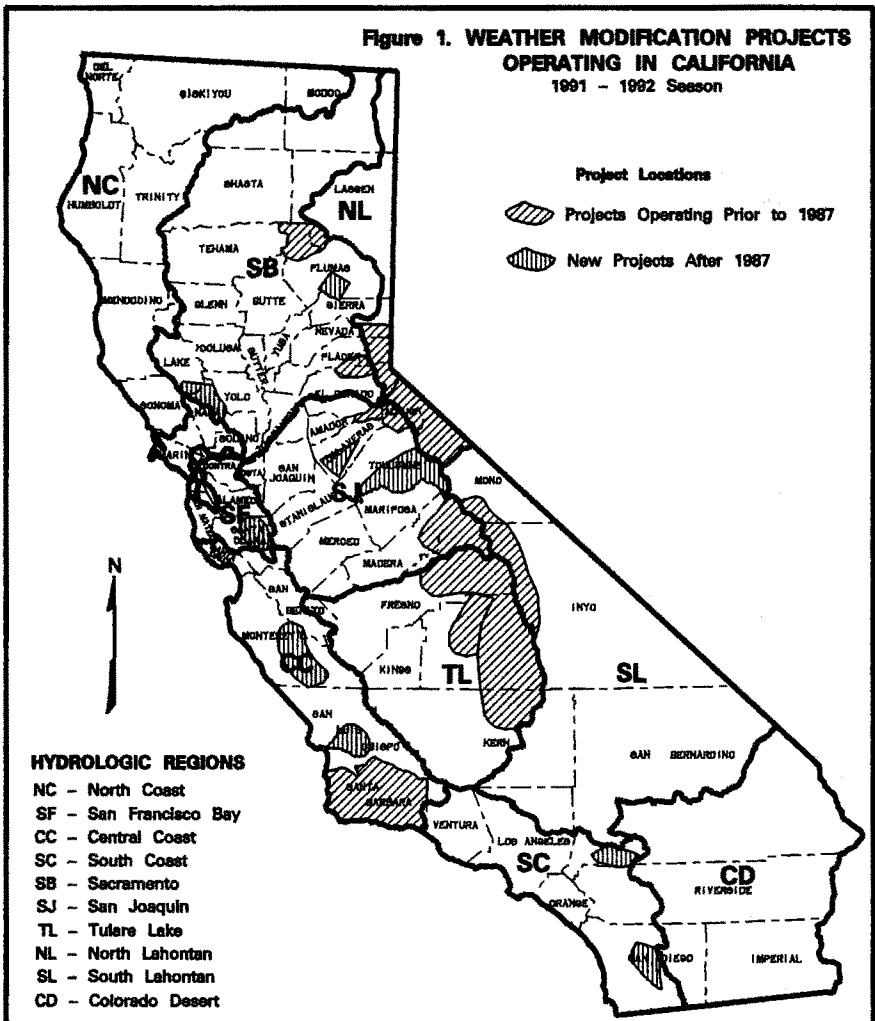

The increase in interest and activity during the current 6-year drought is, to some extent, a measure of desperation. What else can a water manager do? Nevertheless, partly through the support of federal programs in the U.S. Bureau of Reclamation and NOAA, increasing technical groundwork is supporting the basic theory of cloud seeding to enhance precipitation.

THEORY

When air is cooled past the point of saturation (100 percent relative humidity) excess water vapor condenses to form tiny cloud droplets. These droplets form around particles known as cloud condensation nuclei, CCN. Among the microscopic aerosol particles always present in the air, those that are large and hygroscopic are most likely to serve as condensation nuclei. A few of the natural aerosols are special in that cloud droplets can freeze on them or ice crystals can form directly from water vapor. These are called ice nuclei. Usually there is an abundance of CCN but a scarcity of ice nuclei in the atmosphere.

Most clouds are made up of a vast number of water droplets. These cloud droplets are so small it takes one million of them to make one raindrop. These droplets exist in liquid form down to as cold as -40°C or -40°F . When this happens, the droplets are said to be supercooled. The presence of supercooled water in the clouds indicates a scarcity of natural ice crystals in the air.

In the "cold rain" process, tiny ice crystals which are present in the cloud grow into snowflakes at the expense of liquid droplets. The process requires ice crystals, so it takes place only where temperatures are below freezing. (The snowflakes may melt on the way to the ground to fall as raindrops.) As temperatures get colder, more natural ice nuclei are activated. Even in the tropics tops of clouds are often high enough to be below freezing.

The "warm rain" process became known after scientists observed that rain often falls in the tropics from clouds existing entirely at above freezing temperatures. The mechanism for this process is coalescence where larger droplets collide with and coalesce with smaller droplets to eventually form raindrops. Coalescence of liquid droplets can take place below freezing also.

Since many natural clouds are deficient in ice nuclei, injection of artificial ice nuclei can assist nature to start the cold rain precipitation process and increase slightly the efficiency of the rain making process. Seeding with appropriate types and numbers of ice nuclei at the right time and place can enhance precipitation. Silver iodide is commonly used to enhance precipitation because it is a very good ice nucleant. Silver iodide generators can produce as many as 10^{15} particles from one gram of silver iodide. Solid carbon dioxide (dry ice) can also be used to enhance precipitation if applied from an airplane to instantly freeze a path of the tiny liquid cloud droplets. These tiny ice crystals can then be effective nuclei to form snowflakes and start the precipitation process. Liquid propane acts the same way as dry ice in that it chills a zone of liquid particles into ice crystals. The remainder of this paper discusses the use of liquid propane as a seeding agent.

WHY PROPANE?

Almost all operating weather modification projects in the U.S. use silver iodide as the seeding agent. It is applied either from the air or via ground generators which burn a solution of silver iodide and acetone, sometimes with other ingredients, in a propane flame to generate a stream of nuclei. Use of ground generators is much less costly than aerial application, but there are questions about whether the seeding material from ground generators can rise high enough to be effective in orographic precipitation situations. The effectiveness of silver iodide depends on the temperature; it is not very effective at temperatures above -5°C .

During the early phases of the SWP Feather River program, named the Lake Oroville Runoff Enhancement Program (LOREP), rime ice probes were installed on a mountain top in the area. Results from the four years 1987-1991 (which were all drought years) were revealing. The elevation was 6400 feet (1950 meters). The icing indicates supercooled cloud water passing over the peak. Only about 15 percent of the time was the temperature -5°C or colder. About 75 percent of the supercooled water went by in the temperature window -5 to -0°C . Figure 2 shows the six year record of icing at Red Mountain from 1987 through 1992. It is also worthy to note that, even though these were dry years, there were an average of about 250 hours of supercooled water per season from November through April. Thus, it

as apparent that many hours of opportunity existed if an agent could be found to work in the "warmer" temperature window just below freezing, and which could be applied from ground dispensers. Liquid propane seemed to meet the need.

Figure 2. TEMPERATURE DISTRIBUTION

Icing at Red Hill 1987 - 1992

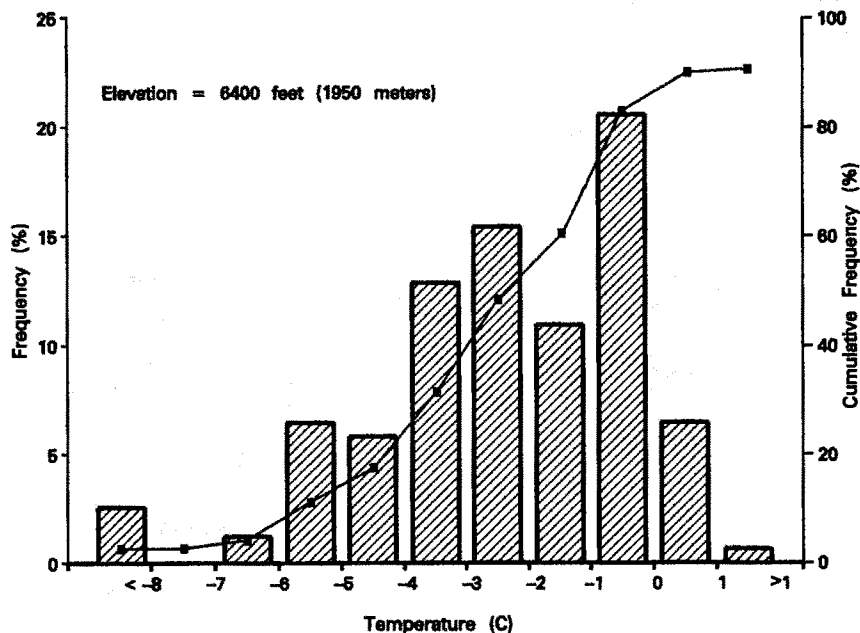

The expansion of liquid propane through a nozzle into a gas produces a small zone of intense cold, instantly freezing the tiny supercooled water droplets into ice crystals which then become the seeding agent. The literature showed that the liquid propane could generate about 5×10^{11} crystals at -2°C . This compares to around 10^{11} to 10^{12} for some special complexes of silver iodide at -5°C (but which are virtually ineffective at -4°C or warmer). The propane will not work if temperatures are above freezing -- the little ice crystals will turn back into water. So now, liquid propane has been identified as a material which is practical and which will work in temperatures just below freezing and which could be dispensed at the ridge tops. Calculations of dispersion indicate that dispensers need to be located cross wind about 3 Km, (2 miles) apart to target an area 10 to 20 Km (10-15 miles) downwind. At a dispersion rate of 2 to 3 gallons per hour, 1000 gallons of propane would be enough to last a season.

THE PILOT PROJECT

In order to test the viability of the use of propane as a seeding agent in the Feather River basin, an experimental 5-year project was proposed and has been underway one year. The necessary environmental documentation and permit process took two years. For the test, 10 propane dispensation units were installed on the ridge between the Middle Fork Feather River and the North Fork Yuba River to the southwest of Johnsville and Plumas Eureka State Park. (See map on Figure 3).

Figure 3. LOCATION MAP
Lake Oroville Runoff Enhancement Prototype Program

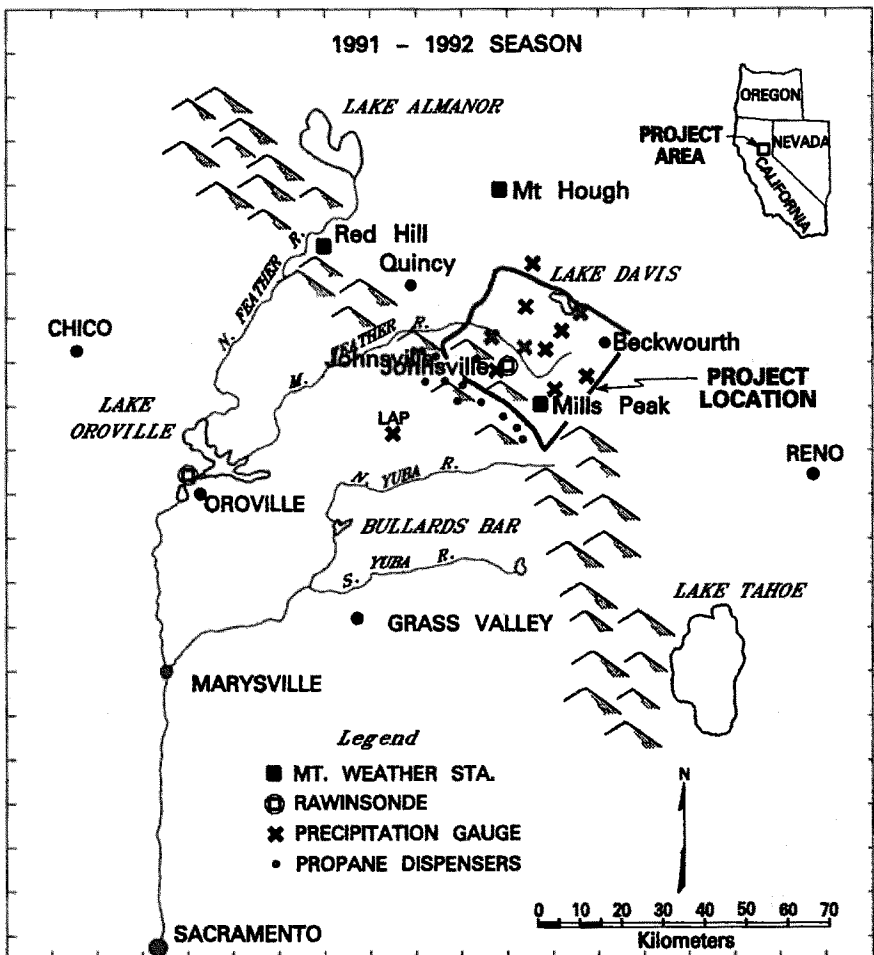

A dispenser consists of two 500-gallon propane tanks, airlifted in by helicopter during the fall, with a vertical standpipe which has three nozzles and a radio controlled valve, flow meter and thermocouple positioned in the propane spray. The valve can be activated by radio; the temperature probe senses whether the propane is actually being released, and the 2nd and 3rd nozzles are for back-up in case the first one gets clogged. By way of the State's telemetry system, the units can be turned on or off from State Water Project headquarters in Sacramento. If no signal is received after six hours, the units will automatically turn off. During the experimental period, when icing conditions are right, as determined by the mountain top icing sensors, 6-hour blocks of time will be randomly seeded or not seeded, with about a 3 to 2 ratio of seed and no-seed events. Figure 4 shows a typical mountain top dispenser unit.

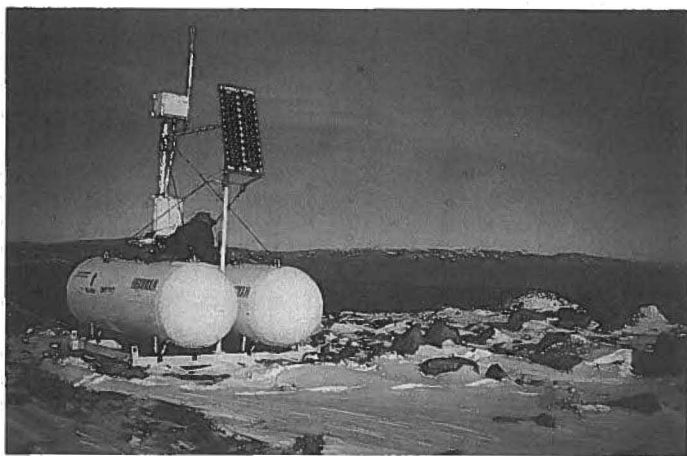

Fig. 4 Typical Mountaintop Dispenser

Permission to operate was obtained from the U.S. Forest Service (on whose land most of the dispensers are located) in November 1991. The 1991-92 season was not a good one in the northern Sierra Nevada, with much less than average orographic precipitation, but 174 hours were seeded and the information is being analyzed. The staff scientist on the project estimated that about 10,000 acre-feet of added precipitation had been generated, but the data is not sufficient to statistically demonstrate an increase.

Calculated rates of production under favorable icing conditions would be about 10 AF per hour per dispenser or 100 AF for the group of 10. This works out to about 0.01 inch per hour in the target area of additional snow water equivalent. In an average season, these rates could add another 30,000 AF or so, of which about 70 percent would be additional runoff. The precipitation gage comparison of seed and no-seed events this past season did not have enough events to prove or disprove the project's enhancement of snowpack and how well the propane worked. Remember, this is a five year experiment. The propane works; the key question is how well it works in the ridge-valley-ridge cross section of the project area. It is conceivable, if the orographic airflow hugs the terrain too much, that many of the ice crystals found near the dispensers could be lost (melted) in the valley during transit in the warmer storm systems. If so, there is a targeting problem which may require relocating some dispensers. Sulfur hexafluoride gas has been used as a tracer on some cloud seeding experiments to help assess where the seeding agent goes. Here too, there is a lot of variation in storms; some act one way, others another way. If a number of storms do have airflow which follows the terrain with less than calculated mixing, this will decrease the number of seeding opportunities and the yield of the propane project. Relocating the dispensers back from the ridge crest may help. Silver iodide would not be subject to this drawback, but the opportunity time for ground based silver iodide is less in many of the storms because of the warmer temperatures.

Further experimental work is planned during the coming winter, with some minor changes in the program. More effort will go into trying to trace the path of the tiny ice crystals from their formation until they fall as additional precipitation, mostly as snow. The planned effort will include some aerial as well as ground sampling of tracer material released at the propane dispenser sites. Environmental monitoring of potential seeding impacts on rare plants, water quality and sedimentation, and fish and wildlife will continue.

If, after several years, the pilot program appears to be successful, it would be expanded into a full fledged operational program to include as many as 50 propane dispensers. To do so would require a new environmental document. By that time, better information should be available, including costs, from the pilot program results and the environmental studies now underway.

SOCIAL CONCERNS

So far, this paper has dealt with the technical concerns in attempting to increase water supply with cloud seeding. There is more to weather modification, especially in areas where local people do not benefit directly from the increases in water supply or hydroelectric power. As a result, their concern tends to focus on the problems and the uncertainties in cloud seeding operations.

Some of the more commonly expressed objections include increased flooding potential, increased snow removal costs, added erosion, robbing downwind people of their water, changes in plant and animal communities, and, in this case since propane is used, increased smog and greenhouse impacts. The most common objection seems to be fear of causing or increasing the potential for a flood. This can be dealt with by incorporating suspension criteria into project operation designed to shut off operations prior to a major flood producing storm. Application of suspension criteria requires a good job of monitoring what is happening in the target basin and also skillful weather forecasts.

There isn't space to go into more detail on these issues here, but objections to seeding do need to be addressed in good faith by sponsors of weather modification projects. Otherwise, opposition to cloud seeding projects could end what appears to be a promising source of some additional water at relatively low cost with few environmental impacts.

For those interested in learning more about weather modification projects, I recommend a 1983 publication by the American Society of Civil Engineers entitled "Guidelines for Cloudseeding to Augment Precipitation", by the Committee on Weather Modification of the Irrigation and Drainage Division. That booklet was developed to help water managers in undertaking cloud seeding. An ASCE task force is now working on updating that publication; a new manual should be available in a year or so.

ACKNOWLEDGEMENTS

The author wishes to thank Mr. David Reynolds, U.S. Bureau of Reclamation, and Mr. Jerry Boles of the Department of Water Resources for helpful reviewing remarks on this paper.

REFERENCES

ASCE 1983 Guidelines for Cloud Seeding to Augment Precipitation, by the Committee on Weather Modification of the Irrigation and Drainage Division.

Reynolds, D. W., 1989: Design of a Ground-Based Snowpack Enhancement Program Using Liquid Propane, Journal of Weather Modification, Vol. 21, Page 29-34.

Reynolds, D.W., 1991: Design and Field Testing of a Remote Ground-Based Propane Dispenser, Journal of Weather Modification, Vol. 23, Pages 49-53.

U.S. Bureau of Reclamation, August 1981: Sierra Cooperative Pilot Project, Environmental Assessment and Finding of No Significant Impact.

U.S. Forest Service, CA Department of Water Resources, September 1990: Joint EIR-EIS, Prototype project to augment snowpack by cloudseeding using ground-based dispensers in Plumas and Sierra Counties.

U.S. Forest Service, CA Department of Water, August 1991: Draft Supplement to the above EIS.

SHAM ABUEL-NAGO

*Los Angeles County Agricultural
Department*

401 South Kingsley Drive, #321
Los Angeles, CA 90020

SEMAVI AKAY

*General Directorate of the State
Hydraulic Works (DSI)*

Investment and Planning Department
Yucetepe
Ankara, 06100
Turkey

ESTER C. ANDREWS

10466 East San Salvador Drive
Scottsdale, AZ 85258

RMELLA APODACA

Soil Conservation Service, USDA

201 East Indianola, Suite 200
Phoenix, AZ 85012

RVEY O. BANKS

Consultant

3 Kittle Lane
Belmont, CA 94002

RALD M. BASTIAN

Salt River Project

P.O. Box 52025, PAB106
Phoenix, AZ 85072

LPH B. BAUMER, JR.

Bureau of Reclamation

3757 South Nelson Way
Denver, CO 80235

NDY E. BINGHAM

Burley Irrigation District

Route 1, Box 1416
Burley, ID 83318

RL BORONKAY

*Metropolitan Water District
of Southern California*

P.O. Box 15453
Los Angeles, CA 90054

RMAN BOUWER

Agricultural Research Service, USDA

4331 East Broadway
Phoenix, AZ 85040

CHESTER V. BOWLING

Bureau of Reclamation

2800 Cottage Way
Sacramento, CA 95825

L. ALBERT BROWER

Bureau of Reclamation

P.O. Box 25007
Denver, CO 80228

JOSEPH I. BURNS

Consulting Civil Engineer

1730 Cathay Way
Sacramento, CA 95864

CHARLES CARUSO

Soil Conservation Service, USDA

10432 Manzanillo, NE
Albuquerque, NM 87111

FIKRET CENGIZ

General Directorate of the State

Hydraulic Works (DSI)

Dam and HEPP Department
Yucetepe
Ankara, 06100
Turkey

RANDY CHANDLER

Bureau of Reclamation

P.O. Box 9980
Phoenix, AZ 85068

MOHAMMAD N. CHEEMA

University of California, Davis

4-G Solano Park
Davis, CA 95616

PAUL A. CHERRINGTON

Salt River Project

P.O. Box 52025
Phoenix, AZ 85072

JAMES CHERRY

Bureau of Reclamation

P.O. Box 61470
Boulder City, NV 89006

LEE J. CLARK

University of Arizona,

Safford Ag Center

P.O. Box 1015
Safford, AZ 85548

ROBERT D. CLARK

Glenn-Colusa Irrigation District
P.O. Box 150
Willows, CA 95988

ALBERT J. CLEMMENS

Agricultural Research Service, USDA
4331 East Broadway
Phoenix, AZ 85040

NEIL M. CLINE

Santa Ana Watershed Project
11615 Sterling Avenue
Riverside, CA 92503

WAYNE CLYMA

Colorado State University
AERC - Foothills Campus
Fort Collins, CO 80523

EVAN CURTIS

Bureau of Indian Affairs
P.O. Box 10
Phoenix, AZ 85001

MERT DAHN

State of Arizona
3800 North Central, Suite 1200
Phoenix, AZ 85016

GRANT G. DAVIDS

CH2M Hill, Inc.
3840 Rosin Court, #110
Sacramento, CA 95834

GERALD M. DAVISSON

Palo Verde Irrigation District
180 West 14th Avenue
Blythe, CA 92225

MICHAEL J. DAY

Provost and Prichard, Inc.
3636 North First Street, Suite 123
Fresno, CA 93726

WAYNE O. DEASON

Bureau of Reclamation
P.O. Box 25007, D-5150
Denver, CO 80225

ALLEN R. DEDRICK

Agricultural Research Service, USDA
4331 East Broadway
Phoenix, AZ 85040

REMER J. DEKLE

Soil Conservation Service, USDA
201 East Indianola Avenue
Phoenix, AZ 85012

ARNOLD K. DIMMITT

*Metropolitan Water District
of Southern California*
107 South 5th Street, Suite 200
Imperial, CA 92243

THOMAS DONNELLY

National Water Resources Associati
3800 North Fairfax Drive, Suite 4
Arlington, VA 22203

LARRY R. DOZIER

*Central Arizona Water
Conservation District*
23636 North 7th Street
Phoenix, AZ 85024

LARRY J. EDWARDS

Aero-Metric Engineering, Inc.
4708 South College Avenue
Fort Collins, CO 80525

RONALD J. EFFERTZ

Bureau of Reclamation
866 Armada Place
Boulder City, NV 89005

RICHARD L. ERICKSON

*East Columbia Basin Irrigation
District*
P.O. Box E
Othello, WA 99344

BERK ERTEM

*General Directorate of the State
Hydraulic Works (DSI)*
Operation and Maintenance Department
Yucetepe
Ankara, 06100
Turkey

ATARINO ESQUIVEL

Consultant
984 El Camino Way
Boulder City, NV 89005

ARY L. ESSLINGER

Elephant Butte Irrigation District
P.O. Drawer A
Las Cruces, NM 88004

ENNIS FALASCHI

Panoche Drainage District
52027 West Althea Avenue
Firebaugh, CA 93622

ARVIN FALES

*South Columbia Basin
Irrigation District*
P.O. Box 1006
Pasco, WA 99301

LAN FEHRMAN

Arizona Department of Water Resources
15 South 15th Avenue
Phoenix, AZ 85007

YRL FISK

Salt River Project
P.O. Box 52025, PAB106
Phoenix, AZ 85072

'AN W. FLINT

*Weber Basin Water
Conservation District*
2837 East Highway 193
Layton, UT 84040

EFFREY W. FREDERICKS

Colorado State University
Department of Civil Engineering
Fort Collins, CO 80523

ARALD D. FREDERIKSEN

World Bank
4107 Lorcom Lane
Arlington, VA 22207

ICHEL GAVILLET

Hydroplus International
P.O. Box 54
Ridgewood, NJ 07450

CURTISS W. GILLEY

Tremont Equipment Company, Inc.
6940 Tremont Road
Dixon, CA 95620

HAL GOBLE

Leupold & Stevens, Inc.
P.O. Box 688
Beaverton, OR 97075

WALKYRIA FONTES GONCALVES

Utah State University
Biological and Irrigation Engineering
Logan, UT 84321

ROBERT S. GOOCH

Salt River Project
P.O. Box 52025
Phoenix, AZ 85072

HERBERT W. GREYDANUS

Bookman-Edmonston Engineering, Inc.
455 Capitol Mall, Suite 230
Sacramento, CA 95814

SAMMIE D. GUY

Bureau of Reclamation
6384 Dockser Terrace
Falls Church, VA 22041

WENDELL R. GWINN

Consultant
906 South Kings Highway
Stillwater, OK 74074

THOMAS R. HAIDER

Bureau of Reclamation
P.O. Box 25007, D-3120
Denver, CO 80225

TAHIR HAMEED

University of California, Davis
10-C Solano Park
Davis, CA 95616

LELAND A. HARDY

Soil Conservation Service, USDA
100 Centennial Mall North, Room 152
Lincoln, NE 68508

GEORGE H. HARGREAVES

Utah State University
1660 East 1220 North
Logan, UT 84321

ALAN D. HARRISON

Bureau of Reclamation
P.O. Box 25007, D-5711
Denver, CO 80225

DAVID L. HEINERT

Salt River Project
P.O. Box 52025
Phoenix, AZ 85072

BENJAMIN HENRY

Navajo Nation, Water Development
P.O. Box 6005
Shiprock, NM 87420

VILMA HORINKOVA

*South Florida Water Management
District*
3301 Gun Club Road
West Palm Beach, FL 33405

GEORGE F. HOROWITZ

4911 Lockhaven Avenue
Los Angeles, CA 90041

DAVID C. IWANSKI

Agri-Business Council of Arizona
2406 South 24th Street, E-103
Phoenix, AZ 85034

CHRIS JENSEN

Okanogan Irrigation District
Route 1, Box 114
Okanogan, WA 98840

J. RONALD JOHNSTON

Bureau of Reclamation
P.O. Box 60340
Grand Junction, CO 81506

STEPHEN M. JONES

Bureau of Reclamation
P.O. Box 61470
Boulder City, NV 89006

MOHAN REDDY JUNNA

University of Wyoming
Department of Civil Engineering
Laramie, WY 82071

NIHAT KARADAYI

*General Directorate of the State
Hydraulic Works (DSI)*
Dam and HEPP Department
Yucetepe
Ankara, 06100
Turkey

OZCAN KAYACAN

*General Directorate of the State
Hydraulic Works (DSI)*
Directorate of Region XIII
Antalya,
Turkey

FERAYI KAYIKET

*General Directorate of the State
Hydraulic Works (DSI)*
Dam and HEPP Department
Yucetepe
Ankara, 06100
Turkey

EDIB KIRDAR

EK Associates
1725 East Jolla
Tempe, AZ 85282

CHARLES J. KISSEZ

Salt River Project
P.O. Box 52025, PAB106
Phoenix, AZ 85072

KARL R. KLINGELHOFER

64245 East Idlewind Lane
Tucson, AZ 85737

ROBERT E. LARCHICK

Salt River Project
P.O. Box 52025
Phoenix, AZ 85072

EDUARDO A. LATIMER

CH2M Hill, Inc.
5210 East Williams Circle
Tucson, AZ 85711

ERMAN LEE

Navajo Nation, Water Development
P.O. Box 678
Fort Defiance, AZ 86504

AVID B. LEVINE

Agricultural Research Service, USDA
819 North Carolina Avenue, SE
Washington, DC 20003

ONALD L. LLOYD

Precision Controls, Inc.
Geomation Inc.
6920 South Kelly Circle, Suite 250
Englewood, CO 80112

ALTER L. LONG

Bureau of Reclamation
P.O. Box 25007, D-3120
Denver, CO 80225

OBERT T. MADLER

*Central Arizona Water
Conservation District*
5622 West Redfield Road
Glendale, AZ 85306

ENRY MAGALLANEZ

Elephant Butte Irrigation District
P.O. Drawer A
Las Cruces, NM 88004

EANE M. MANBECK

Harza Engineering Company
937 West Douglas Avenue
Naperville, IL 60540

ATRICK G. MANGAN

Bureau of Reclamation
P.O. Box 25007
Denver, CO 80225

ICHAEL H. MANSFIELD

*East Columbia Basin Irrigation
District*
P.O. Box 179
Othello, WA 99344

DWARD C. MARTIN

University of Arizona
Mac Farm
37860 West Smith-Enke Road
Maricopa, AZ 85239

KENNETH R. MARTIN

Huma Gro
5 North Roosevelt
Chandler, AZ 85226

VICTOR B. MCINTYRE

*Department of Water Resources,
State of California*
3374 East Shields Avenue
Fresno, CA 93726

JOHN W. MCMULLEN

Precision Controls, Inc.
Geomation Inc.
6920 South Holly Circle, Suite 250
Englewood, CO 80112

JOHN L. MERRIAM

*California Polytechnic
State University*
235 Chaplin Lane
San Luis Obispo, CA 93405

THOMAS E. MITCHELL

Bureau of Reclamation
8801 West Jewell Place
Lakewood, CO 80227

CLIFF A. NEAL

*Central Arizona Water
Conservation District*
23636 North 7th Street
Phoenix, AZ 85024

JOHN OSTERBERG

Bureau of Reclamation
P.O. Box 25007
Denver, CO 80225

MUHARREM OZDEMIR

*General Directorate of the State
Hydraulic Works (DSI)*
Design and Construction Department
Yucetepe
Ankara, 06100
Turkey

HASSAN PACAL

*General Directorate of the State
Hydraulic Works (DSI)*
Directorate of Region XXII
Trabzon,
Turkey

TERRY D. PARSONS

Colorado River Indian Tribes
P.O. Box 3025
Parker, AZ 85344

LEROY PAYNE

Innovative Process Corporation
415 North 16th Street
Billings, MT 59101

DANIEL H. PHILLIPS

Salt River Project
P.O. Box 52025
Phoenix, AZ 85072

TIMOTHY S. PHILLIPS

Salt River Project
P.O. Box 52025
Phoenix, AZ 85072

JOSEPH H. RAUCH

Salt River Project
P.O. Box 52025
Phoenix, AZ 85072

YVONNE REININK

Salt River Project
8403 South Los Feliz Drive
Tempe, AZ 85284

JOHN A. REPLOGLE

Agricultural Research Service, USDA
4331 East Broadway
Phoenix, AZ 85040

ROGER L. REYNOLDS

Summers Engineering, Inc.
P.O. Box 1122
Hanford, CA 93232

SHIRLEY RISH

Agricultural Research Service, USDA
4331 East Broadway Road
Phoenix, AZ 85040

ROBERT ROBINSON

Coachella Valley Water District
P.O. Box 1058
Coachella, CA 92236

W. MARTIN ROCHE

Turlock Irrigation District
333 East Canal Drive
Turlock, CA 95380

ALFONSO RODRIGUEZ

SunCor
111 West Indian School Road
Litchfield Park, AZ 85340

MAURICE ROOS

*Department of Water Resources,
State of California*
P.O. Box 942836
Sacramento, CA 94236

JIM ROWLEY

Salt River Project
P.O. Box 52025
Phoenix, AZ 85072

B.T.A. SAGAR

ATC Engineering Consultants, Inc.
Suite 500
5660 Greenwood Plaza Boulevard
Englewood, CO 80111

MARLIN SAGGBOY

Navajo Nation, Water Development
P.O. Box 6005
Shiprock, AZ 87420

JEAN P. SAGOUSPE

San Luis Water District
P.O. Box 2135
Los Banos, CA 93635

LEROY J. SALAZAR

Agro Engineering
0210 Road 2 South
Alamosa, CO 81101

ZOHRAB SAMANI

New Mexico State University
Box 3CE
Las Cruces, NM 88003

FREDERICK F. SCHANTZ

Morrison-Knudsen Corporation
180 Howard Street
San Francisco, CA 94105

IL W. SCHILD

Bureau of Reclamation
3157 Delwood Way
Sacramento, CA 95821

ENNIS E. SCHROEDER

Bureau of Reclamation
P.O. Box 9980
Phoenix, AZ 85068

ILLIAM G. SHOPE

U.S. Geological Survey
460 National Center
Reston, VA 22092

ANIEL SMEAL

New Mexico State University
P.O. Box 1018
Farmington, NM 87499

GER P. SONNICHSEN

Washington State University
Department of Ecology,
P.O. Box 47600
Olympia, WA 98804

ARRELL K. SORENSON

Kern County Water Agency
P.O. Box 58
Bakersfield, CA 93302

OFFREY SPENCER

World Bank
1818 H Street, NW, Room E-3041
Washington, DC 20433

ICHAEL R. STANSBURY

HDR Engineering
148 Waverly Way
Kirkland, WA 98033

ARRY D. STEPHENS

*U.S. Committee on Irrigation and
Drainage*
1616 Seventeenth Street, Suite 483
Denver, CO 80202

EXFORD STONE

Bureau of Reclamation
P.O. Box 9980
Phoenix, AZ 85068

THEODOR STRELKOFF

Agricultural Research Service, USDA
4331 East Broadway
Phoenix, AZ 85040

KENNETH STRZEPEK

University of Colorado
CADSWES
2954 Center Green Court South, Suite B
Boulder, CO 80301

MICHAEL D. STUVER

Bureau of Reclamation
P.O. Box 11568
Salt Lake City, UT 84147

JOSEPH B. SUMMERS

Summers Engineering, Inc.
887 North Irwin Street
P.O. Box 1122
Hanford, CA 93232

JAMES R. SWEENEY

*Central Arizona Irrigation and
Drainage District*
P.O. Box 605
Eloy, AZ 85231

STEVEN W. TANIS

Salt River Project
P.O. Box 52025, PAB106
Phoenix, AZ 85072

EARL L. TANKERSLEY

Salt River Project
P.O. Box 52025
Phoenix, AZ 85072

AYHAN TASKIN

*General Directorate of the State
Hydraulic Works (DSI)*
Design and Construction Department
Yucetepe
Ankara, 06100
Turkey

O. L. TENNEY

*Maricopa - Stanfield Irrigation
District*
P.O. Box 870
Stanfield, AZ 85272

DAVID THAEMERT

Natural Resources Consulting Engineers
11 Old Town Square, Suite 250
Fort Collins, CO 80524

JOHN M. THOMAS

SIPLAST
222 West Las Colinas Boulevard,
Suite 1600
Irving, TX 75039

KIRK THOMPSON

Colorado State University
2354 Southwest 10th Street, #1
Loveland, CO 80537

PAUL J. TILP

Consultant
11064 West Ohio Place
Lakewood, CO 80226

FAYIK TURAN

*General Directorate of the State
Hydraulic Works (DSI)*
Investment and Planning Department
Yucetepe
Ankara, 06100
Turkey

MIGUEL TURCIOS

University of California, Davis
18-A Solano Park
Davis, CA 95616

EDWARD VIDMAR

Bureau of Reclamation
P.O. Box 11568
Salt Lake City, UT 84138

SHELLEY VUICICH

California Farm Water Coalition
423 West Fallbrook Avenue, Suite 201
Fresno, CA 93711

DAVID G. WAGNER

Colorado State University
Agricultural and Chemical Engineering
Fort Collins, CO 80523

ROBERT WEBB

U.S. Geological Service
1675 West Anklam Road
Tucson, AZ 85745

JOHN WEDDINGTON

World Vision
P.O. Box 15741
San Luis Obispo, CA 93406

LOWELL O. WEEKS

K & W Farms, Inc.
74420 Covered Wagon Trail
Palm Desert, CA 92260

DOUGLAS H. WEGENER

Bureau of Reclamation
P.O. Box 25007, D-3120
Denver, CO 80225

DOUGLAS G. WELCH

Imperial Irrigation District
P.O. Box 937
Imperial, CA 92251

GERALD L. WESTESEN

Montana State University
Civil and Agricultural Engineering
Boseman, MT 59717

RICHARD A. WESTMORE

GEI Consultants, Inc.
5660 Greenwood Plaza Boulevard, #202
Englewood, CO 80111

REBECCA WESTRA

Bureau of Reclamation
P.O. Box 25007
Denver, CO 80225

DENNIS WICHELNS

University of Rhode Island
Department of Resource Economics
Kingston, RI 02881

HARVEY R. WILLIAMS

Shafter-Waslo Irrigation District
P.O. Box 158
Waslo, CA 93280

DAVID S. WILSON, JR.

Bookman-Edmonston Engineering, I
340 East Palm Lane, Suite 250
Phoenix, AZ 85004

UL N. WILSON

University of Arizona
Department of Agricultural Economics
Tucson, AZ 85721

MES M. WOLF

Development Alternatives, Inc.
4811 Chippendale, #702
Sacramento, CA 95841

RELL D. ZIMBELMAN

*Northern Colorado Water
Conservancy District*
P.O. Box 679
Loveland, CO 80539