

EXTENDED STUDIES OF
RATING BROAD CRESTED V-NOTCH WEIRS
WITH NARROW SLOPING APPROACH CHANNELS

By

BRENT W. MEFFORD

JAMES F. RUFF

KEITH SAXTON

USDA-ARS SPECIFIC AGREEMENT

No. 12-14-3001-556



CIVIL ENGINEERING DEPARTMENT
COLORADO STATE UNIVERSITY
ENGINEERING RESEARCH CENTER
FORT COLLINS, COLORADO

OCTOBER, 1979

CER78-79JFR53

217^{43280S}
XL 553
11/00 38-000-00 GBC

EXTENDED STUDIES OF
RATING BROAD-CRESTED V-NOTCH WEIRS
WITH NARROW SLOPING APPROACH CHANNELS

by

James F. Ruff, Associate Professor, Civil Engineering, Colorado
State University, Fort Collins, Colorado.

Brent W. Mefford, Hydraulic Engineer, Bureau of Reclamation,
Denver, Colorado

Keith E. Saxton, USDA-SEA, Pullman, Washington (formerly of
Columbia, Missouri)

A report of research conducted cooperatively by the
USDA Agricultural Research Service, North Central Region,
North Central Watershed Research Unit, Columbia, Missouri
and the Colorado State University, Engineering Research
Center, Fort Collins, Colorado.

USDA-ARS Specific Agreement

No. 12-14-3001-556

October, 1979

CER78-79JFR53

AN INTERPRETIVE SUMMARY

EXTENDED STUDIES OF RATING BROAD CRESTED V-NOTCH WEIRS WITH NARROW SLOPING APPROACH CHANNELS

James F. Ruff, Associate Professor, Civil Engineering, Colorado State Univ.
Brent W. Mefford, Hydraulic Engineer, Bureau of Reclamation,
Denver, Colorado
Keith Saxton, USDA-SEA, Washington State University

Introduction

The U. S. Soil Conservation Service (SCS) developed a triangular broad-crested weir in 1937 for installation in small watersheds. The objective of this weir development was to provide a precalibrated stream flow metering installation for small watersheds. Precalibration of the original broad-crested V-notch weirs was performed with models using fixed bed approach channels with low velocities approaching the weirs. Numerous weirs were installed in the field. Later inspection of the installations showed that the field conditions generally failed to conform to the limits of the original model studies and the question of precalibration validity arose.

Further investigations of the broad-crested V-notch weir were conducted by Ruff, et al [1977]¹, as a review of the original work and to delineate calibration effects of sediment laden flows with varying approach channels. Ruff's investigation indicated the calibrations were affected by the approach channel slope and cross sectional area. This report is an extension of Ruff's work and focuses on approach channel conditions that affect the rating of the SCS broad-crested V-notch weir.

The latest study was conducted using model weirs at different scales to develop a laboratory rating from which the field hydrologist can predict rating influences defined by on-site approach conditions. The major areas of the study involved: (1) developing weir calibrations to cover a range of channel conditions, (2) defining channel slope-area effects on weir ratings and (3) evaluating effects due to changes in the approach channel bed elevations below the weir notch on the weir rating. The model weirs were subjected to simulated flows corresponding to a range of prototype flows from 0.0014 to 84 m³/s. Approach channel slopes were varied between 0.0 and 1.5 percent involving both subcritical and supercritical flows. Approach channels with circular and trapezoidal cross sections and several different side slopes were studied. Channel beds upstream from the weir with elevations of 0.0, 0.15, 0.3 and 0.45 m below the weir notch were tested. All measurements referred to in this paper are prototype unless specifically identified as model dimensions.

¹ Dates appearing in the brackets refer to literature references at the end of this summary.

Weir Calibration Model Tests

The SCS broad-crested V-notch weir was economical to construct, durable and accurate throughout a wide flow range for approach channels with small bed slopes. Details of the weir are shown in Figure 1. The discharge of the broad-crested V-notch weir is expressed by

$$Q = C_D g^{0.5} \tan \frac{\theta}{2} \left(H + \alpha_1 \frac{V_1^2}{2g} \right)^{2.5}$$

or

$$Q = C_D g^{0.5} \tan \frac{\theta}{2} H_T^{2.5}$$

where: Q is the discharge with dimensions of $L^3 T^{-1}$;
 C_D is the discharge coefficient, $L^{0.5} T^{-1}$;
 θ is the internal weir angle;
 H is the head above the notch measured 3m upstream, L ;
 α_1 is the kinetic energy correction factor;
 g is the gravity constant, LT^{-2} ;
 V is the average approach velocity, LT^{-1} ; and
 H_T is the total head $H + \alpha_1 \frac{V_1^2}{2g}$, L .

The discharge coefficient is assumed to account for losses, and other factors that may affect the weir rating without having to alter the other variables, i.e. H , V , and θ .

Model tests were conducted to define the approach channel effects on the calibrations of the broad-crested V-notch weirs. Fixed bed models with a model to prototype ratio of 1:10, 1:5, 1:2.5 and 1:1 were tested with head measurements taken 3.0m upstream from the weir center-line.

Numerous channel cross sectional geometries have been tested. Ruff et al [1977] used channel geometries modeled in part from the original SCS work of Huff [1938, 1941a, 1941b, 1942] and from field installations. Generally, the trapezoidal channel geometries modeled in the 1977 study were similar to the channels used in the original tests conducted by Huff and the circular sections were selected to approximate approach channels of USDA-ARS broad-crested V-notch weir flow metering stations near Treynor, Iowa. The channel cross sections chosen for additional testing in this study are shown in Figure 2. These cross sections were selected to broaden the scope of available weir calibrations for generalized approach channel conditions.

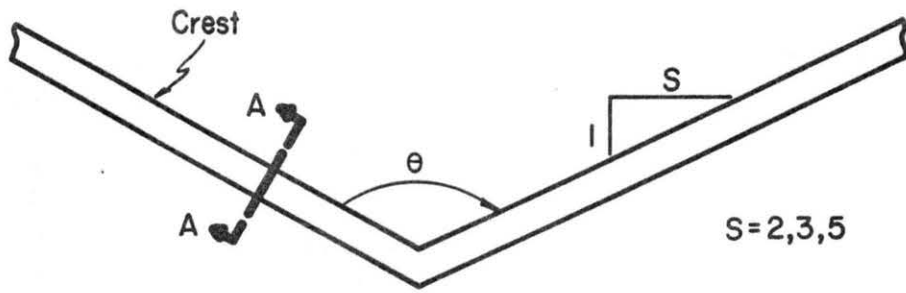

(a) Elevation

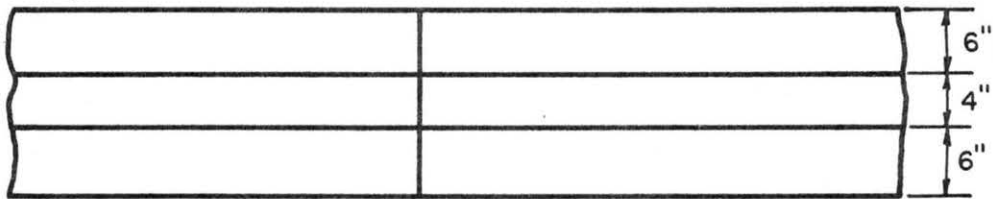

(b) Top View

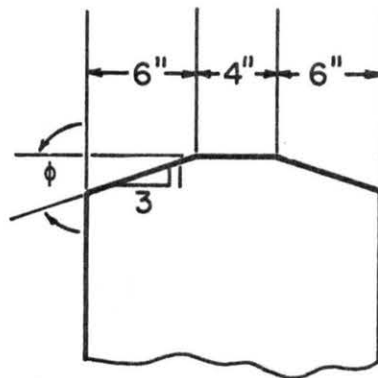

(c) Prototype, Section A-A

Fig. 1 Soil Conservation Service Broad Crested Weir

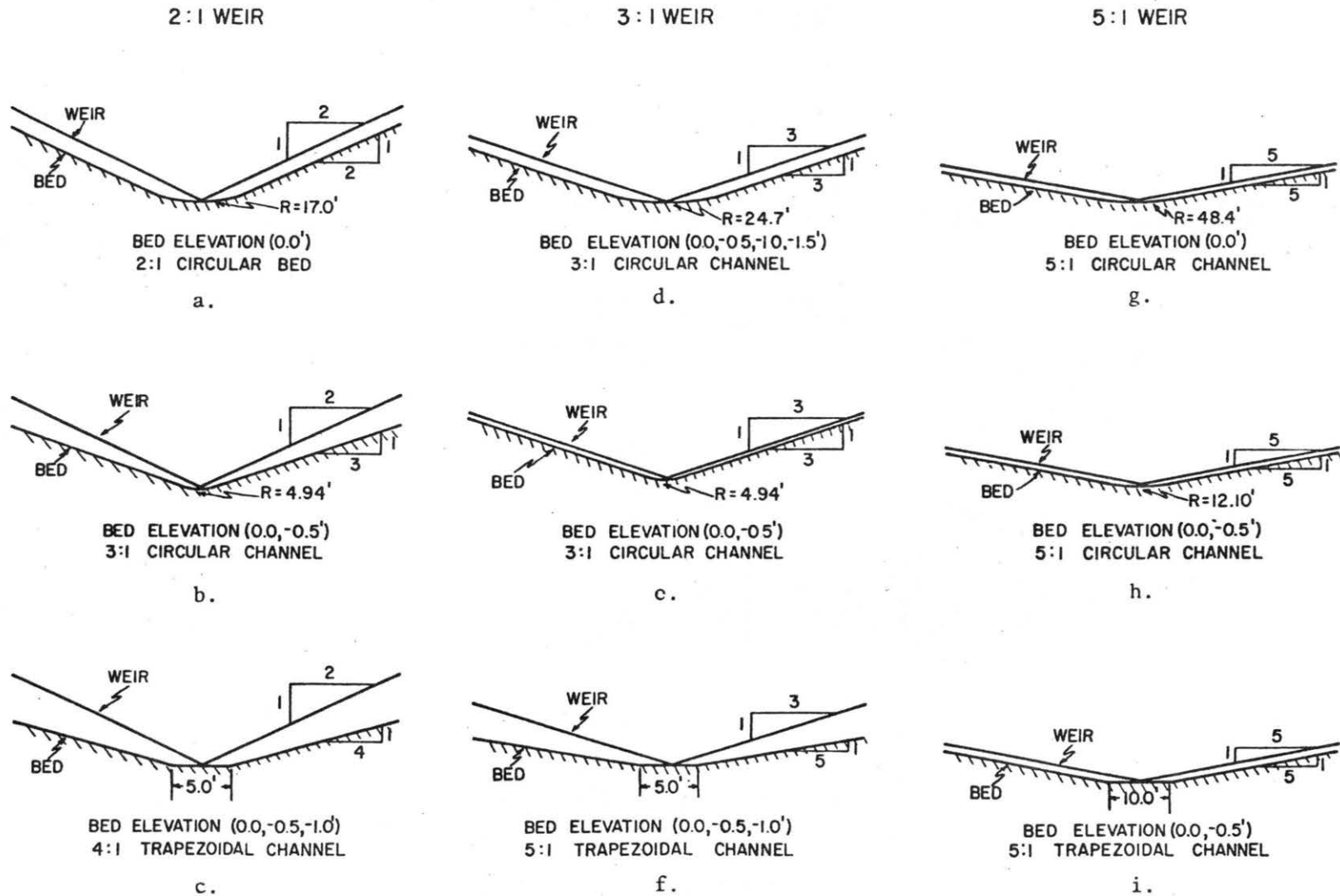

Fig. 2 - Channel Cross Sections Tested

SUMMARY AND CONCLUSIONS

Approach Channel Effects

Rectangular, trapezoidal, and circular channel cross sections were tested mainly at four channel slopes of 0.0, 0.5, 1.0 and 1.5 percent. The approach channel area was varied by changing the location of the notch with respect to the channel bed in addition to using the different geometric cross sections.

There was no obvious effect on the weir rating due to geometric changes in the approach channel area for the 2:1 and 3:1 triangular weirs tested in this study when compared to each other. It is apparent that the tests were not made over a broad enough range of areas. There is an area effect when the channels are compared to a large channel with low approach velocities as evident in Figures 3 and 4 for the generalized curves. Table 1 gives the conditions for which these curves are applicable .

The rating curves for the 5:1 triangular weir shown in Figures 5 and 6 indicate the effect due to changes in approach channel area. Table I gives the conditions representative of the curves shown in Figure 5. Figure 6 demonstrates that the smaller circular channel with a 12.1 ft radius indicates a greater discharge at a given head than the larger circular and trapezoidal channels. These differences in discharge are not evident in Figure 7 when the velocity head is taken into account which reflects the influence of the velocity head component on the total head. The velocity head influence was also observed for the 5:1 triangular weir when the bed elevation is lowered and the approach channel area is thus increased. The most significant effects due to channel area are evident when the channel area decreases and approaches the cross sectional flow area of the weir. In the limit, if these areas are equal, the channel and weir form a chute and the flow is controlled by the slope and channel roughness rather than by the weir.

The approach channel slope also affects the weir calibrations mainly through the approach velocity. This is evident by comparing the plots of head versus discharge shown in Figure 8a, 8b, and 8c with the corresponding plots of total head versus discharge in Figure 9a, 9b and 9c. The addition of the velocity head in Figure 8 tends to make the ratings become more congruent. When the velocity head is not included as in Figure 8, the discharge can differ on the order of 100 percent at heads of 3 to 4 ft. At slopes less than 0.5 percent, the changes in the rating curves can not be readily distinguished.

Numerous runs were tested under supercritical flow conditions. When flow becomes supercritical in the channel, the control also reverts to that due to the channel slope and roughness. There appears to be a smooth transition between the two types of controls for the model channels. This may not be the case for the dynamic and mobile channel beds found in the field. Therefore, the ratings recommended for use are those where the flow is subcritical. The generalized weir rating curves representative of several weir channel conditions are presented in Figures 3, 4, and 5 for the 2:1, 3:1 and 5:1 triangular weirs, respectively. Table I presents the conditions for which these general curves are applicable.

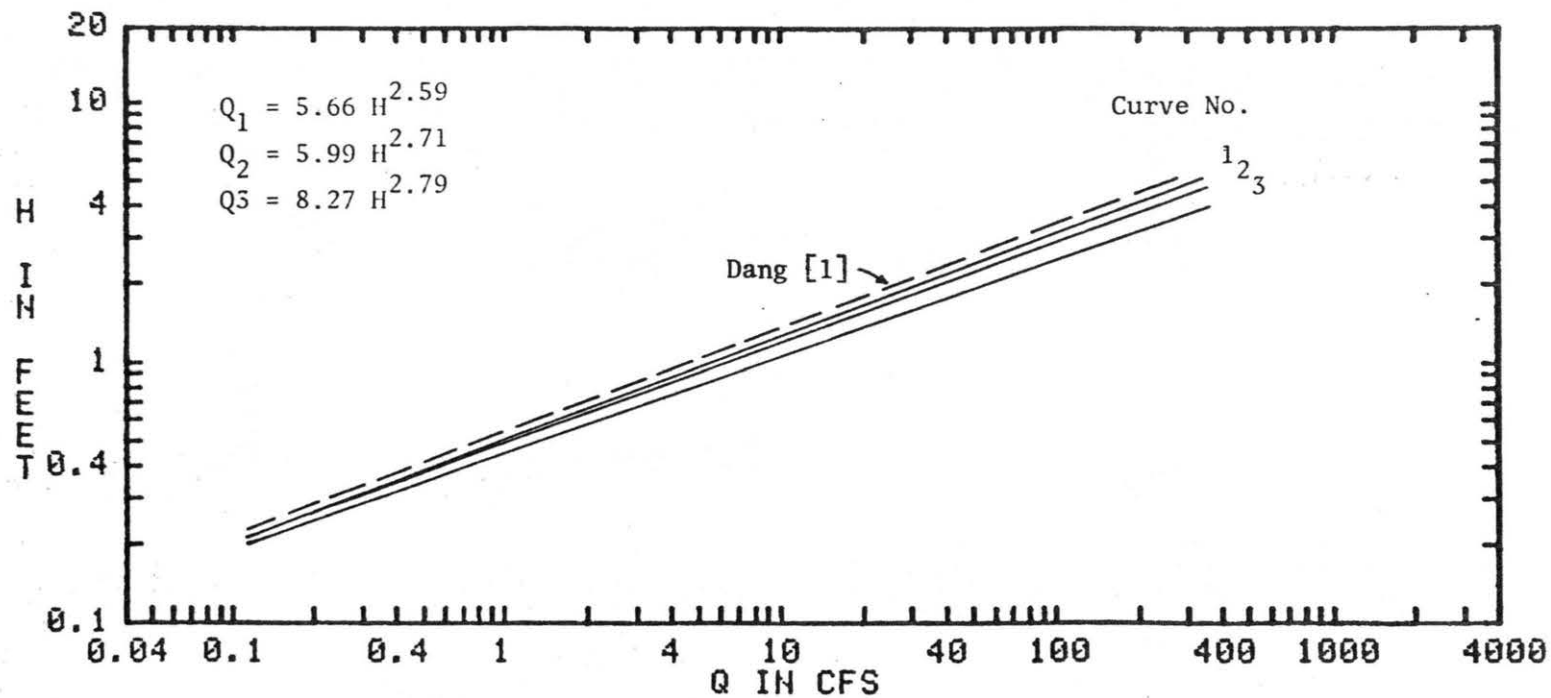

FIG. 3 - GENERALIZED RATING CURVES, 2:1 WEIR

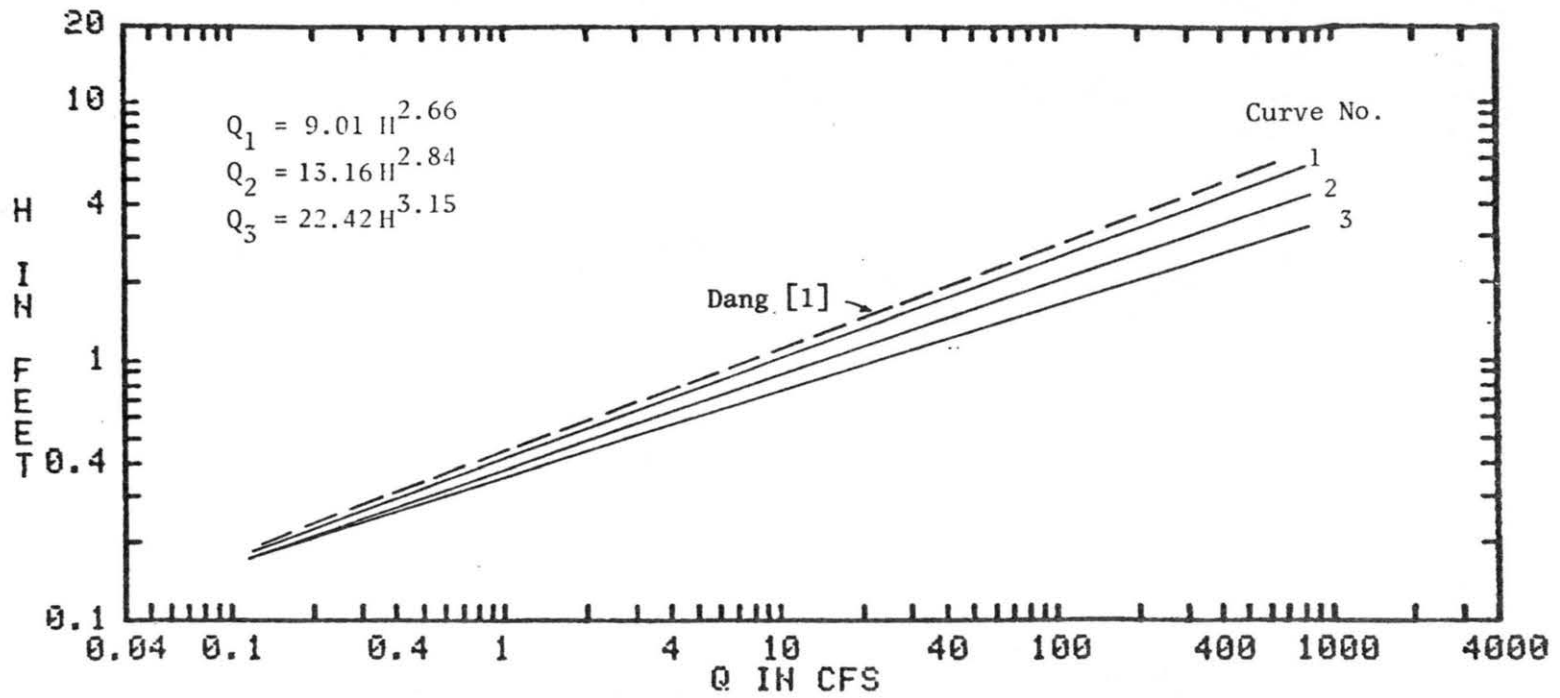

FIG. 4 - GENERALIZED RATING CURVES, 3:1 WEIR

TABLE I
Classification of Weir Rating Effects

Rating Curve	Channel Conditions	
	Bed Slope	Bed Elevations
<u>2:1 Weir</u>		
16-1	0.0%	-0.5', -0.0'
	0.5%	-0.5', -0.5'
	1.0%	-0.5'
16-2	1.0%	-0.0'
16-3	1.5%	-0.0'

<u>3:1 Weir</u>		
17-1	0.0%	-0.5', -0.0'
	0.5%	-0.5', -0.0'
	1.0%	-0.5'
	1.5%	-0.5'
17-2	1.0%	-0.0'
17-3	1.5%	-0.0'

<u>5:1 Weir</u>		
18a-1	0.0%	-0.0', -0.5'
	0.5%	-0.0', -0.5'
	1.0%	-0.5'
18a-2	1.0%	-0.0'
	1.5%	-0.0', -0.5'
18b-1	0.0%	-0.0', -0.5'
	0.5%	-0.5'
	1.0%	-0.5'
18b-2	0.5%	-0.0'
18b-3	1.0%	-0.0'
	1.5%	-0.0', -0.5'

ix

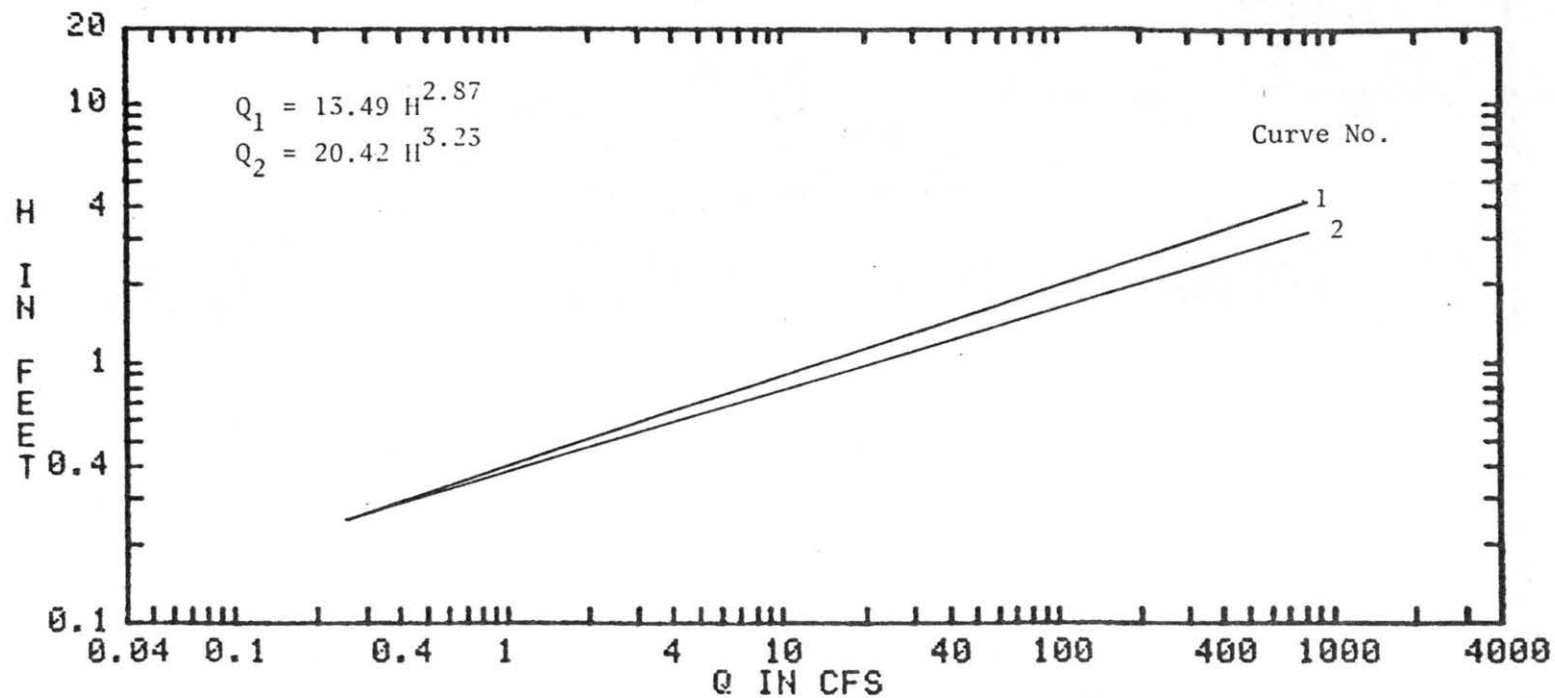

FIG. 5a - GENERALIZED RATING CURVES, 5:1 WEIR

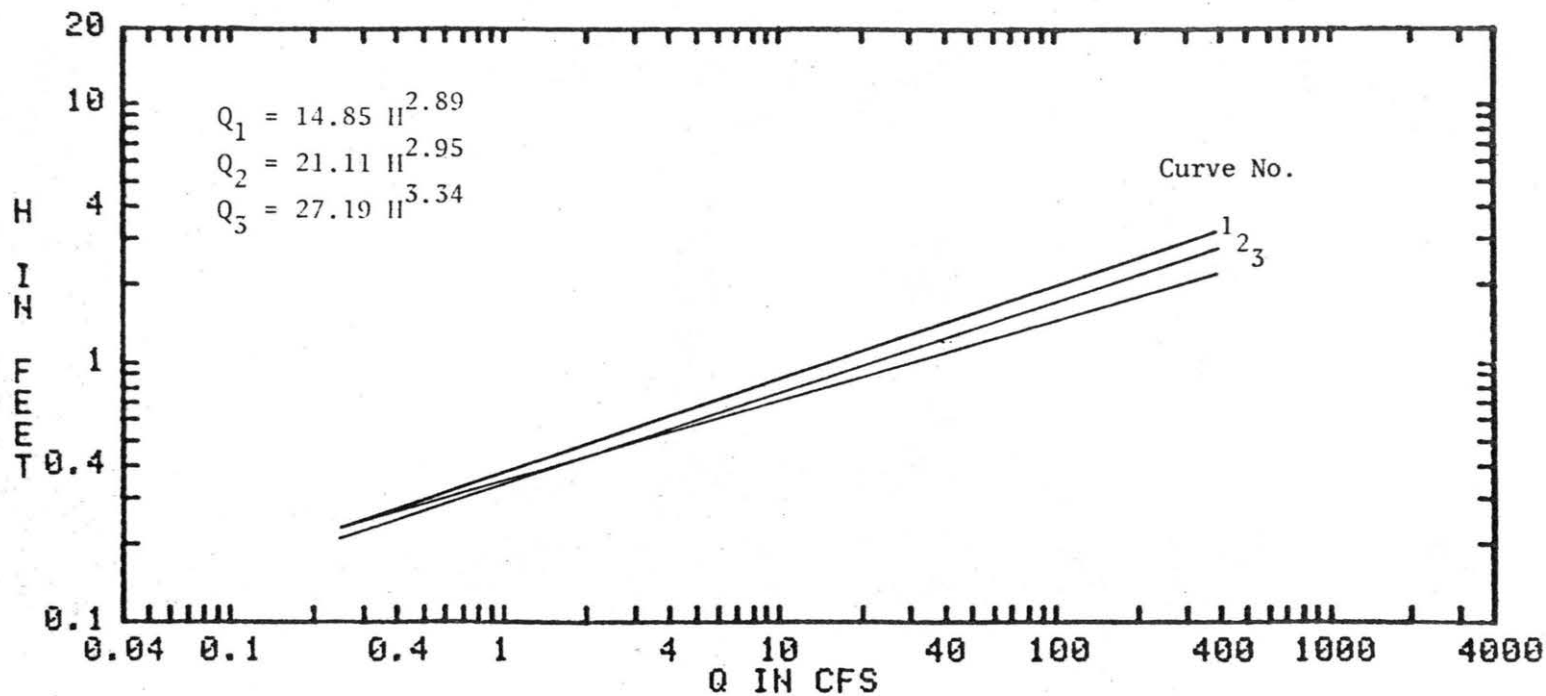

FIG. 5b - GENERALIZED RATING CURVES, 5:1 WEIR

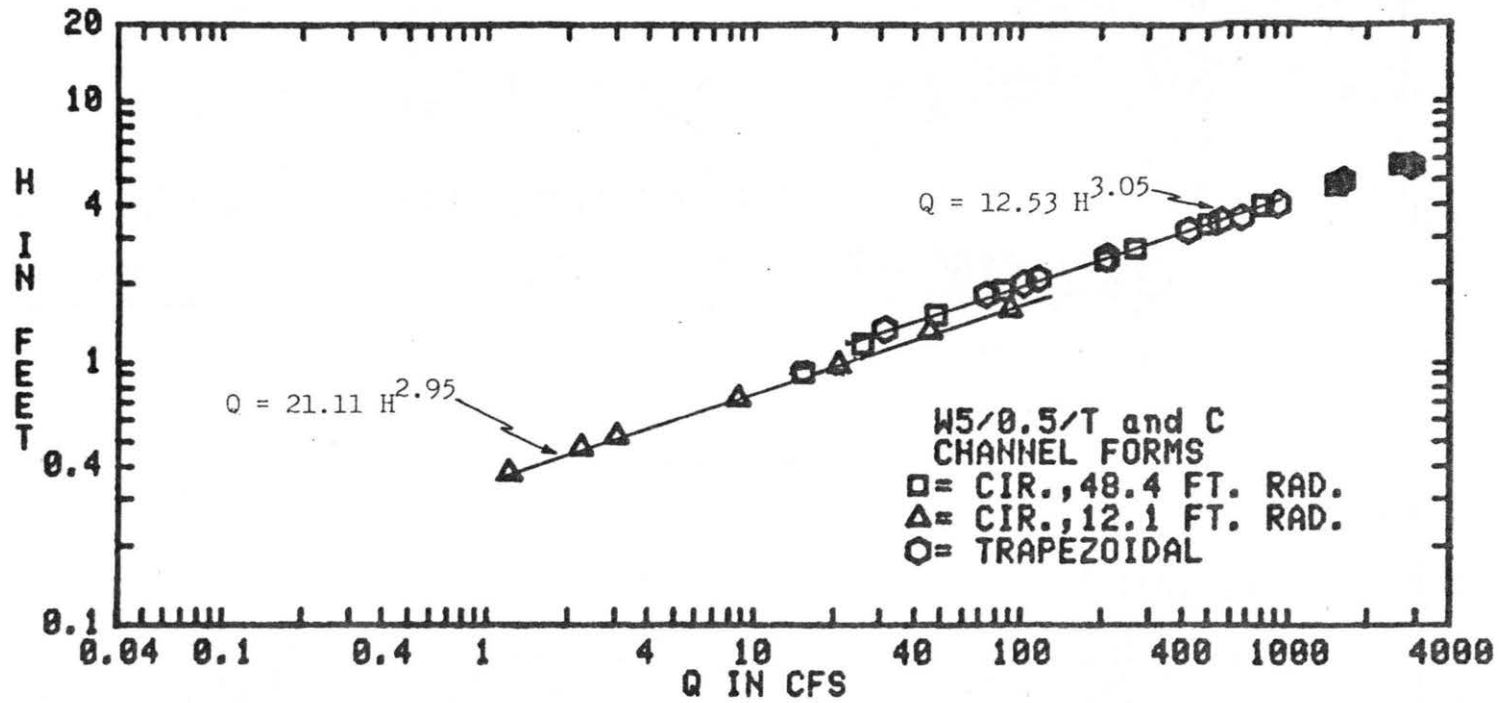

FIG. 6 PLOT OF HEAD versus DISCHARGE DATA POINTS

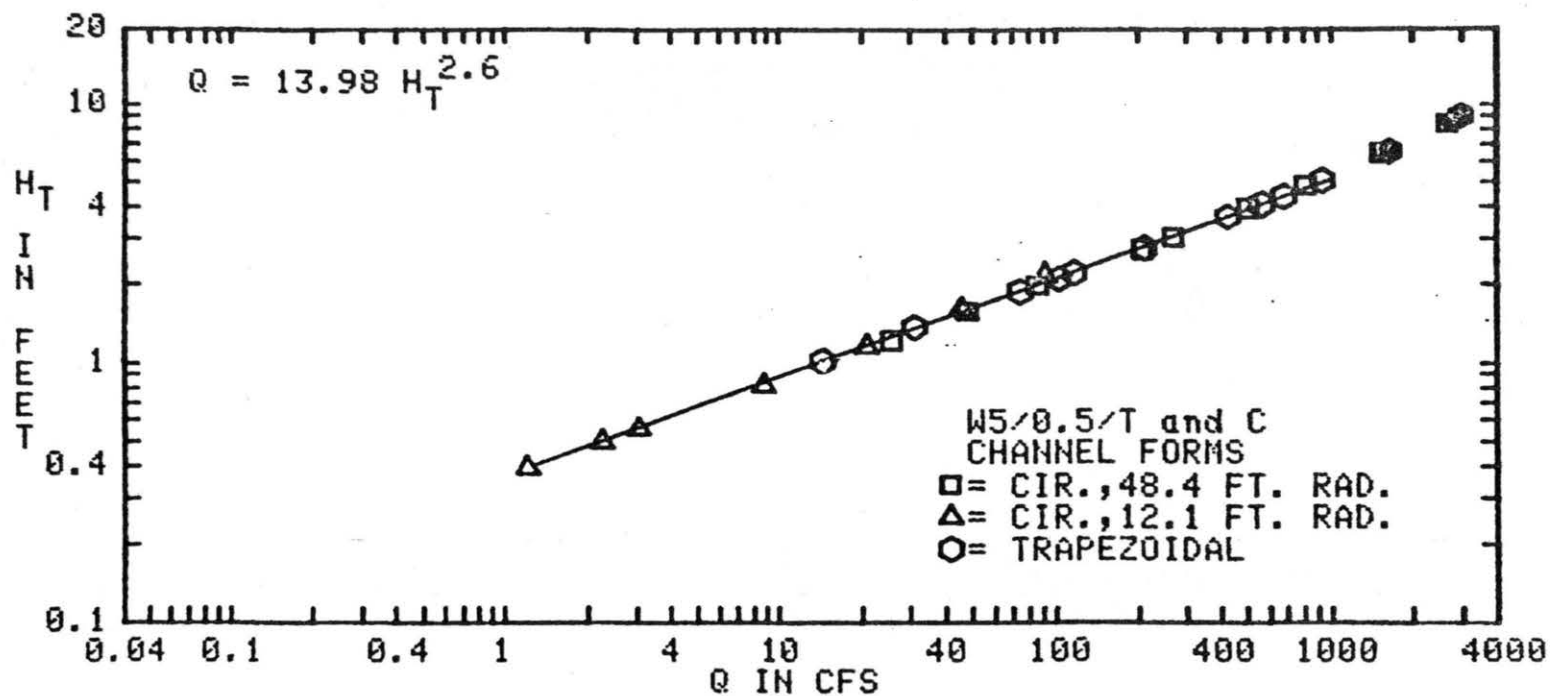

FIG. 7 PLOT OF TOTAL HEAD versus DISCHARGE DATA POINTS

2x

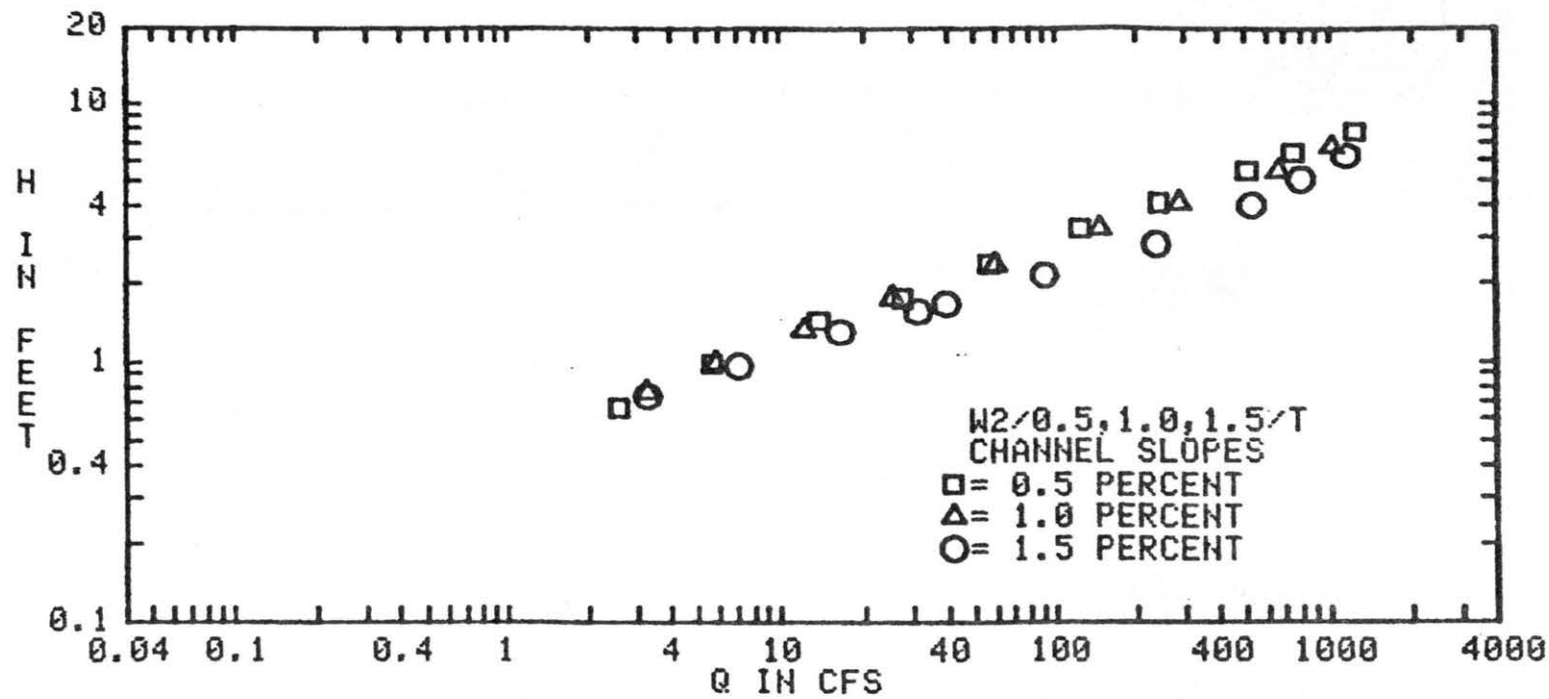

FIG. 8a PLOT OF HEAD versus DISCHARGE DATA POINTS

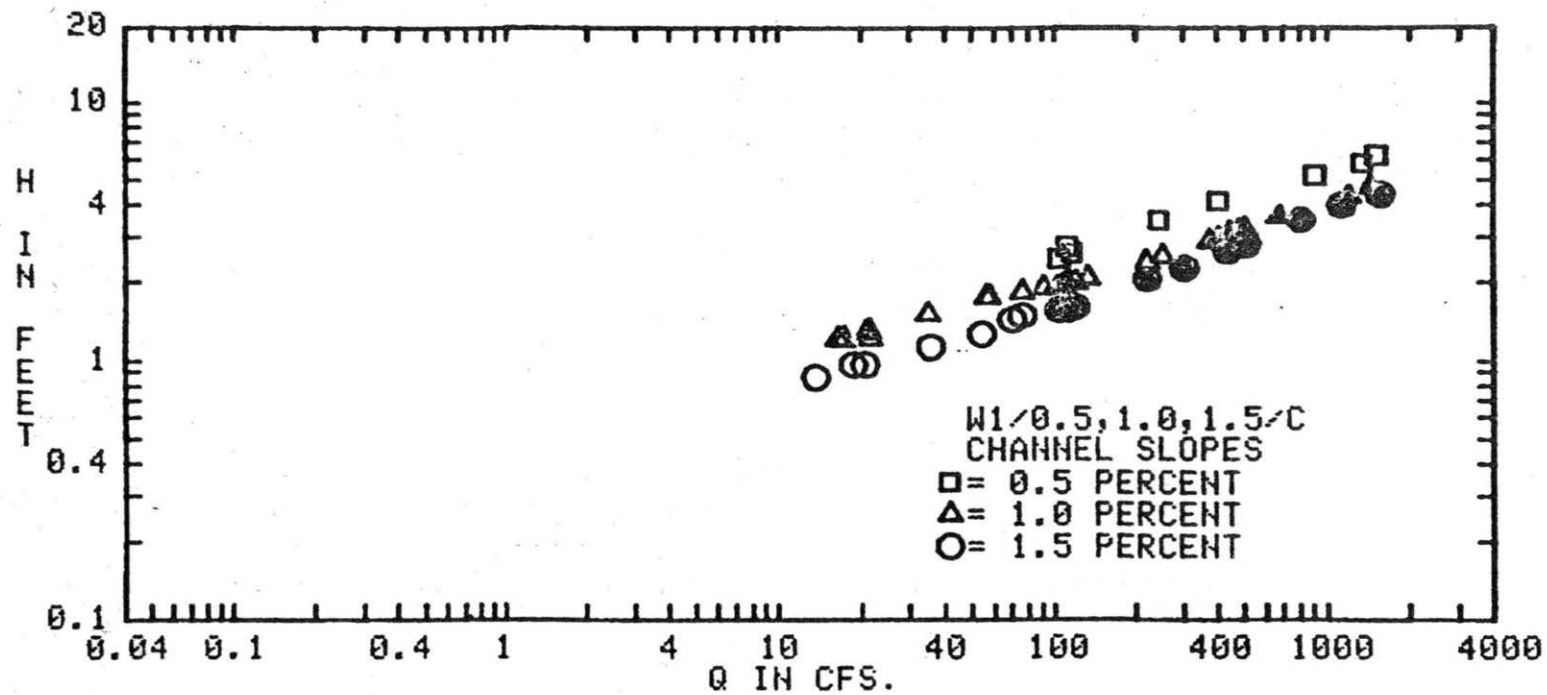

FIG. 8b PLOT OF HEAD versus DISCHARGE DATA POINTS

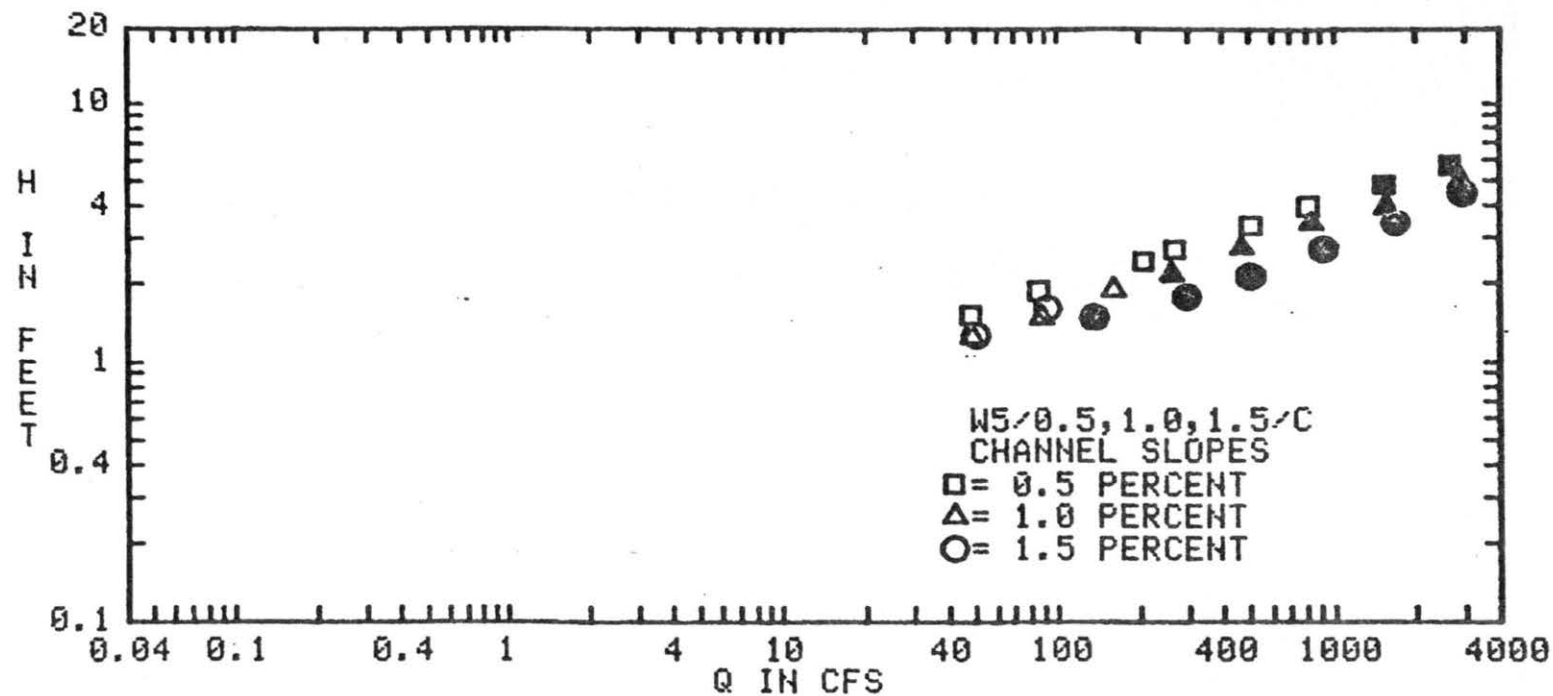

FIG. 8c PLOT OF HEAD versus DISCHARGE DATA POINTS

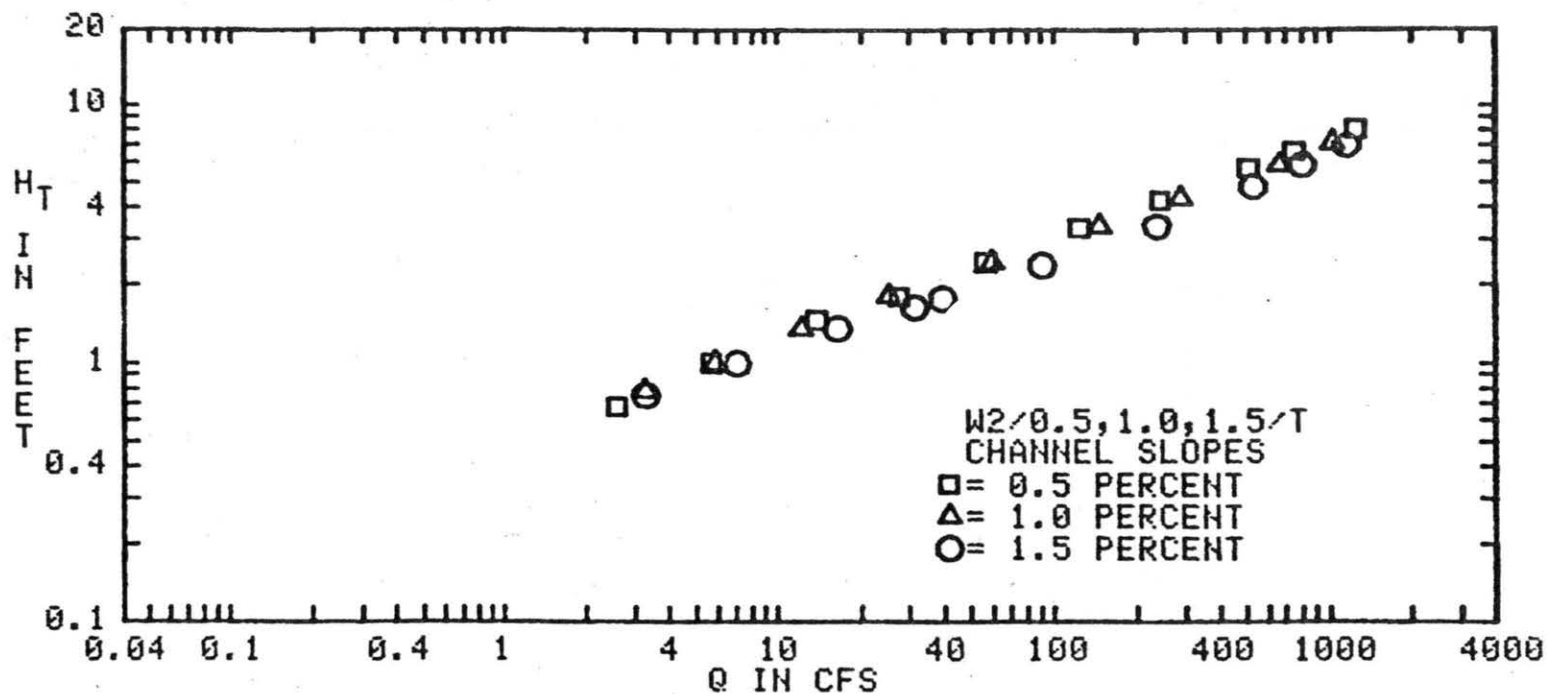

FIG. 9a PLOT OF TOTAL HEAD versus DISCHARGE DATA POINTS

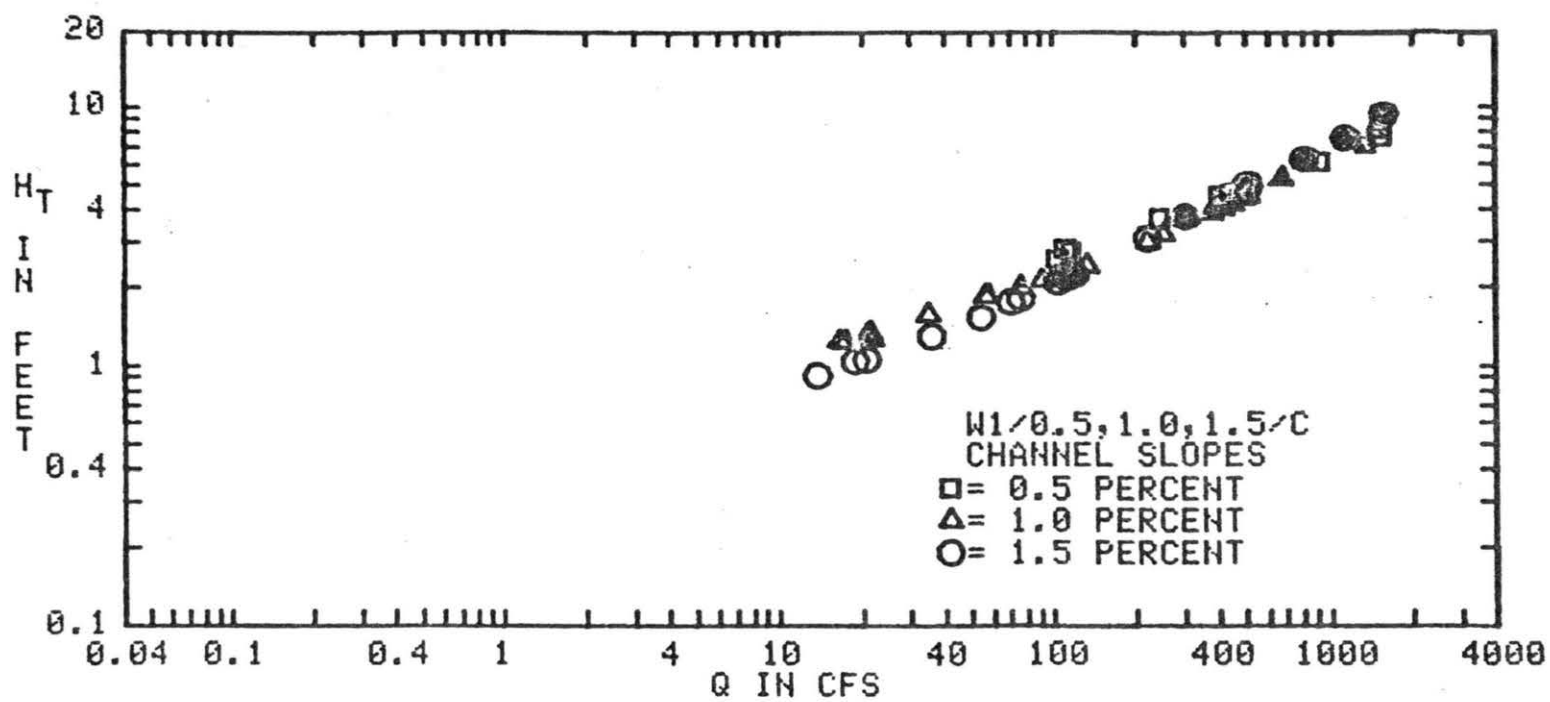

FIG. 9b PLOT OF TOTAL HEAD versus DISCHARGE DATA POINTS

xx

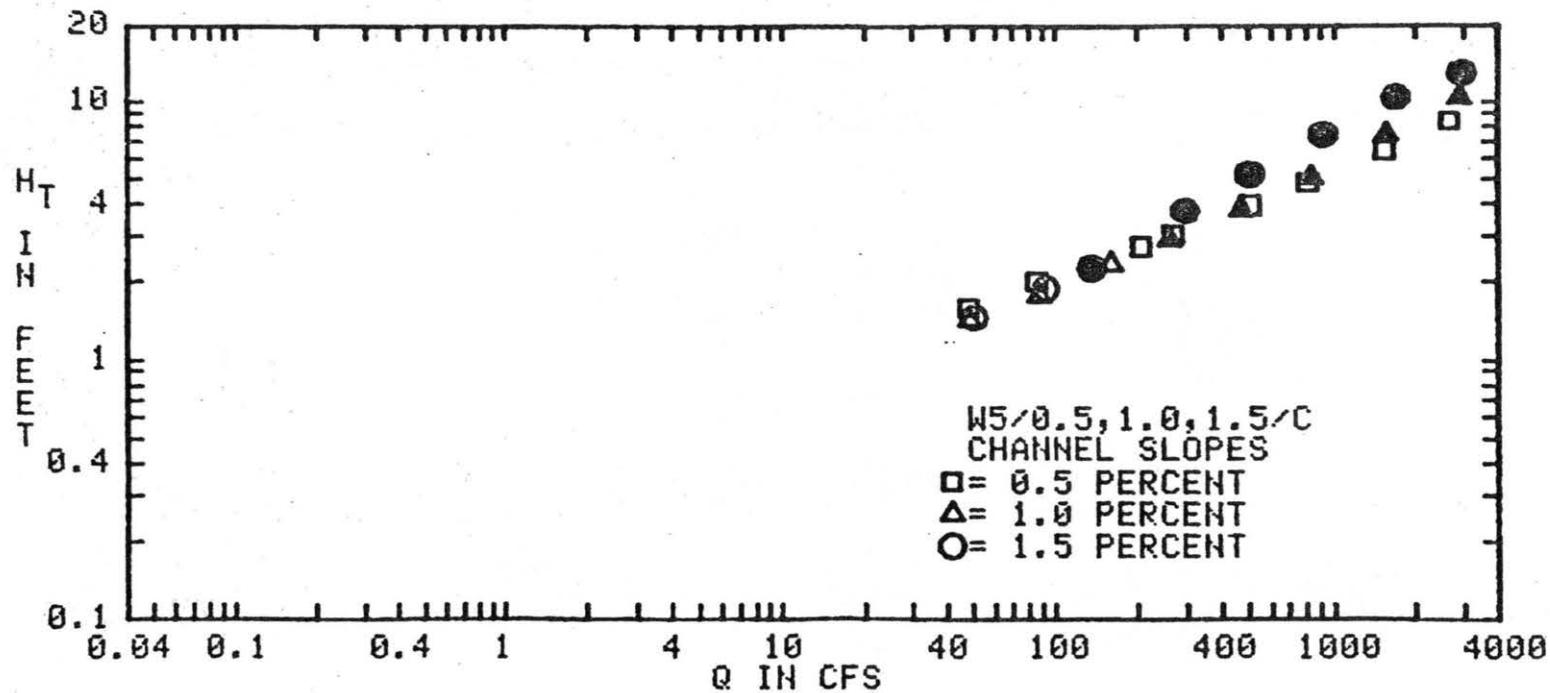

FIG. 9c PLOT OF TOTAL HEAD versus DISCHARGE DATA POINTS

The improved rating determined by this study of the broad-crested V-notch weir will provide a better determination of flow rates for field installations where incorrect ratings or no ratings existed before. Field measurements of approach channel slope and cross section will indicate which rating curve is most appropriate for a given installation. The hydrologist will have improved and accurate flow measurements which can be used to base economic, social, and scientific interpretations.

REFERENCES

1. Dang, C. 1976, "Rating of the Broad Crested V-notch Weir". Master's Thesis, Colorado State University.
2. Huff, A. M., (1938), "Tests of 160-inch Weir and Comparison with 30-inch Weir". Report No. 1, Cornell University, Section of Watershed and Hydrology Studies.
3. Huff, A. M., (1941a), "Calibration of 2:1 V-notch Measuring Weirs". St. Anthony Falls Hydraulic Laboratory, Minneapolis, Minnesota, Report No. MN-R-3-8.
4. Huff, A. M., (1941b), "Calibration of 3:1 V-notch Measuring Weirs". St. Anthony Falls Hydraulic Laboratory, Minneapolis, Minnesota, Report No. MN-R-3-8.
5. Huff, A. M., (1942), "Calibration of 3:1 and 5:1 V-notch Measuring Weirs". Supplement to Calibration of 2:1 V-notch Measuring Weirs. St. Anthony Falls Hydraulic Laboratory, Minneapolis, Minnesota, Report No. MN-R-3-7.
6. Ruff, J. F., Saxton, K. E., and Dang, C., (1977), "A Detailed Report of Rating Broad Crested V-notch Weirs with Narrow, Sloping Approach Channels and Sediment Deposits". Report prepared for USDA, Agricultural Research Service, Colorado State University, Engineering Research Center, CER-76-77JFR-CD53.

TABLE OF CONTENTS

<u>Chapter</u>		<u>Page</u>
	LIST OF FIGURES.	iv
	LIST OF TABLES	v
	LIST OF SYMBOLS.	vi
I	INTRODUCTION	1
	Objectives of this Study.	3
II	BACKGROUND	4
	Weirs	4
	Triangular Broad-Crested Weir	9
	Prior Research.	9
	3:1 Weir Calibrations.	10
	2:1 Weir Calibrations.	12
	Conclusions	12
III	THEORY	14
	Weir Discharge Equations.	14
	Channel Area.	20
	Distance from Bed to Weir	21
	Channel Roughness	21
	Channel Bed Slope	22
IV	MODEL TESTS.	23
	2:1 Weir Tests.	30
	3:1 Weir Tests.	30
	5:1 Weir Tests.	33
V	DATA SUMMARIES	35
	Channel Size Effects.	37

TABLE OF CONTENTS CONTINUED

<u>Chapter</u>		<u>Page</u>
	2:1 Weir.	38
	3:1 Weir.	38
	5:1 Weir.	38
	Bed Elevation Effects.	39
	2:1 Weir.	39
	3:1 Weir.	39
	5:1 Weir.	40
	Channel Slope Effect	40
VI	ANALYSIS.	61
	2:1 Weir	63
	3:1 Weir	64
	5:1 Weir	65
	Coefficient of Discharge	66
VII	SUMMARY, CONCLUSIONS AND RECOMMENDATIONS.	75
	REFERENCES.	78
	Appendix A - TABULATION OF TEST DATA, HEAD VS DISCHARGE DATA PLOTS	
	Appendix B - INDIVIDUAL TOTAL HEAD VS DISCHARGE DATA PLOTS	
	Appendix C - INDIVIDUAL TOTAL HEAD VS C_d DATA PLOTS. .	

LIST OF FIGURES

<u>Figure No.</u>		<u>Page</u>
1	Soil Conservation Service Broad Crested Weir.	2
2	Boundary Layer Development.	6
3 (a-d)	Typical Water Surface Profiles.	8
4	Channels Tested in Conjunction with 3:1 Weir.	11
5	Channels Tested in Conjunction with 2:1 Weir.	13
6a	Longitudinal Cross Section of Flow.	15
6b	Cross Section of Triangular Weir.	15
7	Description of Zero Bed Elevation	26
8	Water Surface Profile Measurement Positions	27
9 (a-i)	Channel Cross Sections Tested	29
10 (a-c)	Plot of Head vs. Discharge Data Points.	42
11 (a-c)	Plot of Total Head vs. Discharge Data Points.	45
12 (a-d)	Plot of Head vs. Discharge Data Points.	48
13 (a-c)	Plot of Total Head vs. Discharge Data Points.	52
14 (a-c)	Plot of Head vs. Discharge Data Points.	55
15 (a-c)	Plot of Total Head vs. Discharge Data Points.	58
16	Generalized Rating Curves, 2:1 Weir	68
17	Generalized Rating Curves, 3:1 Weir	69
18 (a-b)	Generalized Rating Curves, 5:1 Weir	70
19	Coefficient of Discharge Comparisons, 2:1 Weir.	72
20	Coefficient of Discharge Comparisons, 3:1 Weir.	73
21	Coefficient of Discharge Comparisons, 5:1 Weir.	74
A (1-61)	Plot of Head vs. Discharge Data Points.	
B (1-61)	Plot of Total Head vs. Discharge Data Points.	
C (1-61)	Discharge Coefficient Curves, H_T vs. C_d	

LIST OF TABLES

<u>Table</u>		<u>Page</u>
1	Classification of Weirs.	8
2	Chart of Calibration Tests	31
3	Comparisons of 2:1 Weir Rated Discharge.	62
APPENDIX A (1-61) - Tabulated Results of Testing		

LIST OF SYMBOLS

<u>Symbol</u>	<u>Description</u>	<u>Unit</u>
a	Approach channel area, measured 10 ft upstream of weir centerline	L ²
A _P	Prototype flow cross-sectional area	L ²
B	Channel width at water surface	L
C	Circular Channel	-
C _d	Coefficient of Discharge, $C_d = \frac{Q}{g^{1/2} \tan \frac{\theta}{2} H^{3/2}}$	-
dA	Incremental area	-
F	Froude number; $(V_p/[g A_p/\alpha B])^{0/5}$	-
g	Acceleration of gravity	L/T ²
H	Head above weir crest measured 10 ft upstream from weir centerline	L
H _C	Critical depth of flow	L
H _M	Model static head	L
H _P	Prototype static head	L
H _T	Prototype total head, $(H_T = H_P + \alpha H_V, \alpha = 1.116)$	L
H _V	Velocity head, $(V_1^2/2g)$	L
k	Roughness height on the weir plate surface	L
L	Effective weir length perpendicular to the flow	L
p	Bed displacement (distance from weir notch to channel bed)	L
Q	Discharge	L ³ /T
Q _M	Model discharge	L ³ /T
Q _P	Prototype discharge	L ³ /T
Q _T	Theoretical discharge	L ³ /T

LIST OF SYMBOLS CONTINUED

<u>Symbol</u>	<u>Description</u>	<u>Unit</u>
r	Channel roughness	L
R_e	Reynolds number, $\frac{\rho V_1 H}{\mu}$	-
s	Approach channel bed slope	-
T	Trapezoidal channel	-
v	Incremental velocity	L/T
V	Average velocity	L/T
V_1	Average approach velocity	L/T
V_p	Mean prototype velocity at station, measured 10 ft upstream from weir centerline	L/T
W1	3:1 Weir designation	-
W2	2:1 Weir designation	-
W3	5:1 Weir designation	L
W_e	Weber number	L
Y_C	Prototype critical depth of flow	L
Y_N	Prototype normal depth of flow	L
α	Velocity distribution coefficient, 1.116	-
δ	Thickness of the boundary layer	L
γ	Specific weight of the fluid	μ/L^2T^2
μ	Dynamic viscosity of the fluid	μ/LT
ν	Kinematic viscosity	L^2/T
ϕ	Weir edge angle	-
ρ	Fluid density	μ/L^3
σ	Surface tension of the fluid	μ/T^2
θ	Internal weir angle, $[\tan \frac{\theta}{2}]$	-

Chapter 1

INTRODUCTION

The need for accurate discharge measurements of runoff flows occurring on small watersheds often confronts the field hydrologist. In the semi-arid and arid regions of the United States, water is becoming an increasingly scarce resource. Paralleling the increasing demands on water are the tightening reins of water management and, in turn, the need for reliable streamflow measurements from small watersheds. Typically, small watersheds react to runoff occurrences with rapid responses in their streamflows. On-site measurements are thereby complicated by large variations in discharge versus short time frames of stream stage duration. Ruff et al. (1977) cited an example of a discharge hydrograph of a small watershed stream which illustrates a part of the streamflow measurement problems facing the field hydrologist. Streamflow varied from 0.3 cfs to 411.0 cfs in a period of less than 15 minutes. Additional measurement problems exist with the transport of significant amounts of trash and sediment which interfere with gaging.

Starting in 1937, the Section of Runoff Studies of the Division of Research of the U. S. Soil Conservation Service (SCS) developed a triangular broad-crested weir (Figure 1). Utilization was aimed toward a precalibrated streamflow metering installation for small watersheds. These weirs have been used extensively because they are durable, economical, and offer the ability to define discharge as a continuous function of stream stage. Precalibration of the broad-crested V-notch weir was originally performed by Albert N. Huff (1938, 1941a, 1941b, 1942) on fixed bed approach channels in laboratory model studies. Huff found the

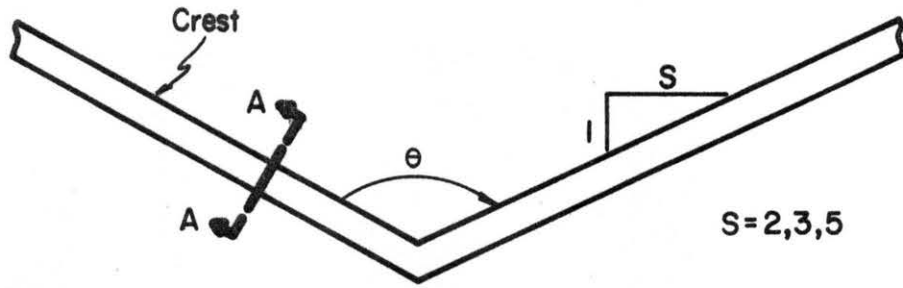

(a) Elevation

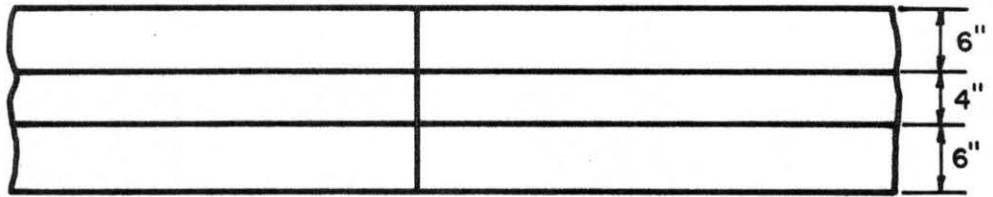

(b) Top View

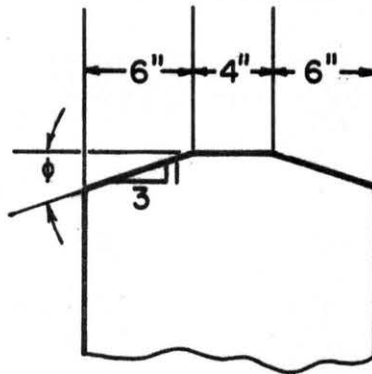

(c) Prototype, Section A-A

Fig. 1 Soil Conservation Service Broad Crested Weir

triangular ("V"-notch) broad-crested weir, developed by the SCS, to provide reliable ratings for channel conditions with low approach velocities. Where field conditions fail to conform within the limits of the original model studies the question of precalibration validity arises.

In 1973 further investigation of the broad-crested V-notch weir was conducted by Ruff et al. (1977) as a review of Huff's work and to delineate calibration effects of sediment laden flows with varying approach channels. This report is an extension of Ruff's work, focusing on approach channel conditions that affect the ratings of the SCS broad-crested "V"-notch weir.

Objectives of this Study

This study was conducted using model weirs of different scales to develop a series of laboratory ratings from which the field hydrologist can predict rating influences defined by on-site approach channel conditions. The major areas of study are:

- (1) developing weir calibrations to cover a range of channel conditions;
- (2) defining channel slope-area effects on weir ratings;
- (3) evaluating weir rating effects due to changes in approach channel bed elevations below the weir notch.

Values are given in prototype dimensions unless specified. Flows were considered within the range of 0.05 cfs to 3000.0 cfs. Approach channel slopes were varied between 0.0 and 1.5 percent involving both subcritical and supercritical flow. Approach channels with circular and trapezoidal cross-sections and varying side slopes were studied. Upstream channel beds with elevations of 0.0 ft., 0.5 ft., 1.0 ft., and 1.5 ft., below the weir notch were tested.

Chapter II

BACKGROUND

Weirs

The weir is a channel constriction designed to provide a control section for streamflow. The control section can then be calibrated for flow metering. The calibrations are conducted under steady state conditions at several discharges. One of the first theoretical equations for measuring flow over a rectangular weir was developed in 1717 by Marquis Giovanni Poleni (Rouse, 1971). Since then a multitude of studies have been conducted to define weir calibrations.

Weirs can be classified into two general categories: sharp crested and broad crested. Sharp-crested weirs are characterized by a "sharp" edge over which the flow springs free of the weir crest. A generalized formula for discharge over a rectangular sharp-crested weir is:

$$Q = C_d g^{1/2} L H^{3/2} \quad (1)$$

where Q is the discharge, C_d is a coefficient of discharge, g is the acceleration of gravity, L is the effective weir length perpendicular to the flow, and H is the head above the weir crest measured at a point upstream of the nappe drawdown and, generally, measured 10 ft upstream from the weir centerline.

"Broad crested" infers a finite crest length in the direction of flow. As such the weir crest adds a second dimension of complexity to

the control section hydraulics. As opposed to "sharp-crested", the nappe of the flow remains in contact with the weir crest. In theory, sub-critical flow approaches the weir and the flow passed through critical depth while on the crest of the weir. The broad-crested weir is thus sometimes described as a critical depth meter. Two primary advantages are associated with critical depth devices: 1) submergence can occur up to critical depth without significantly affecting the upstream head-discharge relationship, 2) the discharge can be defined by a single critical depth measurement. Assuming uniform parallel flow and a knowledge of the location of critical depth a generalized discharge equation for rectangular broad-crested weirs could be:

$$Q = g^{1/2} L H_c^{3/2} \quad (2)$$

where H_c is the critical depth of flow. In the field, the assumptions underlying Equation 2 are seldom met. Flow patterns and the point of critical depth are a function of several variables. Weir geometry, crest roughness, and entrance conditions all influence the system.

To understand the hydraulics of the broad-crested weir, a knowledge of the general flow patterns over a weir is required. Tracey (1957) discussed the flow patterns over a weir crest. His discussions lead to an expanded definition of broad crested. The term "broad crested" must be broken into two parts. In the general sense the term is a function of the crest length in the direction of flow. Secondly, it is defined by the head versus weir geometry relationship. For a broad-crested weir,

with an aerated free overfall and a horizontal crest of fixed geometry the internal and surface flow patterns are dependent on the head-to-crest length ratio.

Under conditions of small head to length ratios the weir crest becomes a channel control. The thickness of the boundary layer, δ , along the crest and the slope of the total head line over the weir become important. The slope of the total head line over the weir becomes large because of the viscous shear losses within the boundary layer. Even though flow may be irrotational through most of the depth, within the boundary layer the shear stresses create a velocity gradient. The average velocity of the boundary layer being less than that of the ambient flow produces a wedge shaped segment of flow of lower discharge resulting in a non uniform flow (Figure 2).

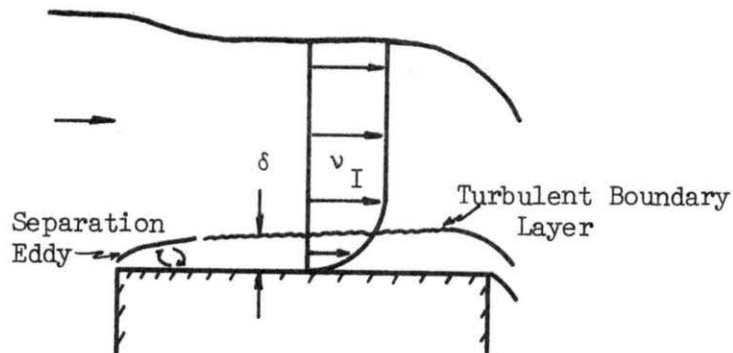

Fig. 2 - Boundary Layer Development

The same weir at intermediate values of head-to-length ratios may produce a separation zone between the flow nappe and the leading edge of the weir (Figure 2). Separation with reattachment on the weir crest produces a localized eddy downstream of the point of separation. The formation of the separation zone redefines the effective boundary of the internal flow patterns over the weir crest.

If sufficiently high head-to-length ratios occur, the nappe will fail to reattach within the limits of the crest length. The nappe will spring clear of the weir crest as a free jet, which is characteristic of sharp-crested weirs.

Surface profiles are characteristic of a weir crest length for a specified head. Flow over a weir of long crest length eventually approaches critical depth on the crest, as the flow accelerates with increased distance from the leading edge. At critical depth the specific head is a minimum. Continued energy losses at or near critical depth requires the flow depth to adjust itself and leads to the formation of standing waves. As the head increases, in relation to the weir length, the water surface profile over the weir traverses lengths of both curvilinear and nearly parallel flow. When the ratio of head to length decreases to the point where only curvilinear flow occurs over the crest, a non uniform pressure gradient due to non parallel flow exists over the entire region of the weir crest (Figure 3).

Broad-crested weirs are often subdivided into three groups based on the resultant surface profiles. Narrow weirs are defined by the complete expanse of fully developed curvilinear flow over the weir crest (Figure 3c). Medium or broad weirs are characterized by zones of curvilinear flow at the leading and trailing edges of the weir crest

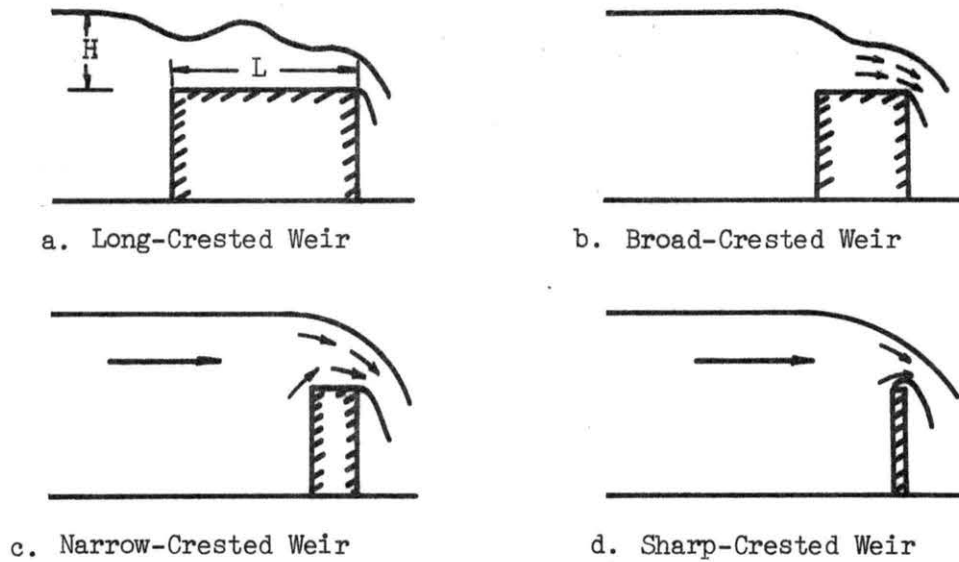

Fig. 3 - Typical Water Surface Profiles

TABLE 1
 Classification of Weirs
 (Govinda Rao, Muralidhar, 1963)

Value of H/L	Nature of Water Surface	Classification of Weir
$0 < H/L < 0.1$	Consists of series of standing waves	Long-Crested Weir
$0.1 < H/L < 0.4$	Parallel to the weir crest for considerable portion	Broad-Crested Weir
$0.4 < H/L < 1.5$ to 1.9 (upper limit dependent on H/p)	Wholly curvilinear	Narrow-Crested Weir
$H/L > 1.5$ to 1.9 (Lower limit dependent on H/p)	Flow separates at the upstream corner and springs clear of the weir crest	Sharp-Crested Weir

bounding a central length of approximately parallel flow. The third group, called long weirs is depicted by the development of standing wave patterns over the weir crest.

Govina Rao and Muralidhar (1963) presented a classification for square-edge, broad-crested weirs based on relative head to length ratios, utilizing flow patterns similar to those discussed above (refer to Table 1).

Triangular Broad-Crested Weir

The triangular broad-crested "V" notch weir infers a third aspect of weir geometry. Triangular refers to the shape of the weir in cross section normal to the direction of flow. The weir forms a "V" across the channel as illustrated in Figure 1.

The purpose of the "V" notch design is to increase the depth of flow over the vortex at low discharge. The triangular shape enables the weir to handle large ranges of discharge without forfeiting sensitivity at the low end. Selection of the angle of the "V", the weir angle θ , determines the low end sensitivity and the range of flow conveyance possible over the weir.

Prior Research

The original research on the Soil Conservation Service broad-crested V-notch weir was conducted by Huff (1938, 1941a, 1941b, 1942) at Cornell and Minnesota Universities. Huff worked mainly with channel bed slopes less than 1 percent and short, fixed bed approach channels. Field installations deviating from the laboratory settings defined by Huff lead to a second level of laboratory testing conducted by Ruff, Dang and Saxton, (1977).

The objectives of the research carried out by Ruff, Dang, and Saxton at Colorado State University were:

1. to verify the original calibration curves for the 2:1 and 3:1 broad-crested V-notch weirs developed by Huff;
2. to derive new rating curves and discharge coefficients for different weir approach channel slopes and cross section combinations;
3. to determine the effects of approach channel deposition; and
4. to determine the energy and momentum correction coefficients for the approach channels tests.

Five to one scale model studies were conducted using a 4 ft x 8 ft x 200 ft recirculating, tilting flume. The test section contained 45 ft (model) of concrete-lined approach channel. The weir plates were constructed from aluminum stock. A slotted stilling well intake, referred to as an integrated intake, was constructed across the channel flush with the bed. The intake was 10 ft upstream of the center of the weir for recording head measurements.

3:1 Weir Calibrations

Ruff et al. (1977) used rectangular, trapezoidal, and circular channel cross sections with the geometries as shown in Figure 4. Empirical calibrations were formulated for 0.0, 0.5, 1.0 and 1.5 percent channel slopes. Additional tests were conducted with the circular approach channel modified to include alluvial deposits modeled in concrete. Dune bed forms measuring 0.5 ft and 1.0 ft were used at a position 10 ft upstream from the weir notch.

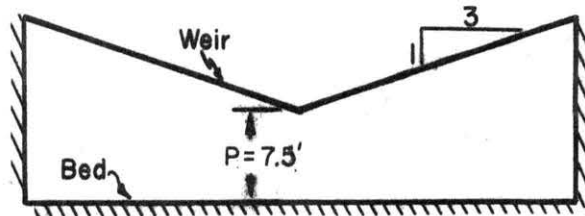

(a) Rectangular Channel

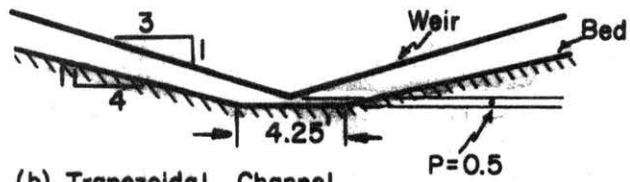

(b) Trapezoidal Channel

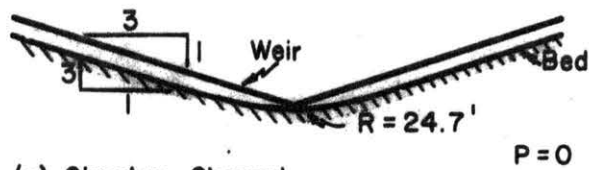

(c) Circular Channel

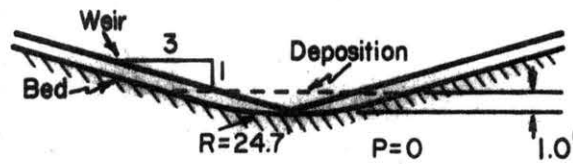

(d) Circular Channel with Severe Deposition

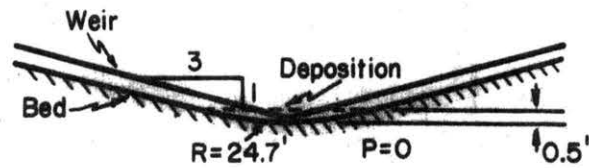

(e) Circular Channel with Moderate Deposition

Fig. 4 - Channels Tested in Conjunction with 3:1 Weir
(Ruff et al. 1977)

2:1 Weir Calibrations

Similar rectangular, trapezoidal, and circular channel cross sections were utilized in the 2:1 weir tests (Figure 5). Again channel slopes from 0.0 to 1.5 percent were tested. Sediment deposition tests were conducted for both the circular and trapezoidal channels as described for the circular channel of the 3:1 weir calibrations.

Conclusions

In general Ruff, Dang, and Saxton found that:

1. Increasing the approach channel slope results in a greater velocity head and an increase in the discharge for a given head on the weir, H .
2. Smaller channel cross sections caused increased flow rates for a given head due to increased approach velocities.
3. The use of total head instead of static head tends to decrease rating curve differences caused by approach channel variations.
4. In general, the rating curves for channels with deposits approached those without deposits at the higher stages and deviated from them at low stages. Curves for 0.5 ft deposits were similar to those without deposits for heads greater than about 2.5 ft. Heads of 4 ft to 6 ft were required before the rating curves for the 1.0 ft deposit approached the non deposit curves. For example, at 2 ft head and 1 percent slope, the discharge is about 109 cfs with no deposition as compared to about 7.3 cfs with 1 ft of deposition.

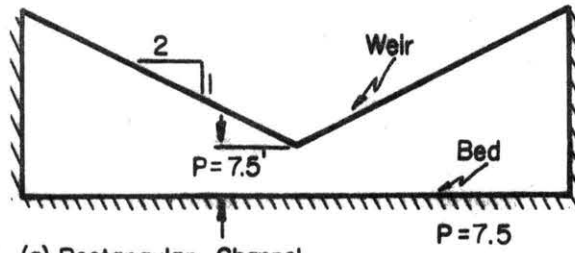

(a) Rectangular Channel



(b) Circular Channel

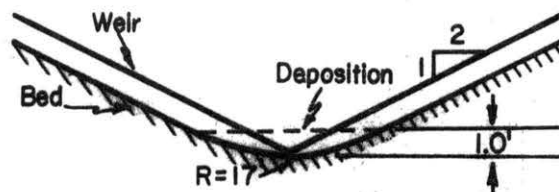

(c) Circular Channel with Severe Deposition

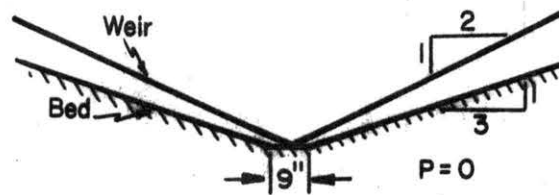

(d) Trapezoidal Channel

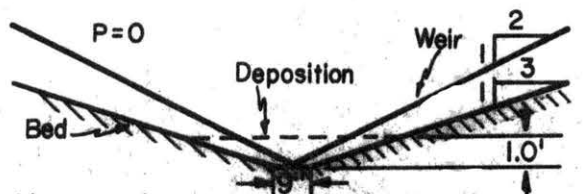

(e) Trapezoidal Channel with Severe Deposition

Fig. 5 - Channels Tested in Conjunction with 2:1 Weir
(Ruff et al. 1977)

Chapter III

THEORY

Weir Discharge Equations

A relationship for the discharge over a weir can be developed by first considering a simplified one-dimensional flow pattern. The flow is assumed as inviscid steady uniform flow within the reach considered and viscous effects are not significant. The triangular weir equation can be developed by utilizing an incremental discharge relation:

$$dQ_T = v dA \quad (3)$$

The incremental velocity, v , is derived from application of the Bernoulli equation between points 1 and 2 (Figure 6a). The incremental area, dA , (Figure 6b) is equal to $(y)dh$. Theoretical discharge, Q_T , can then be expressed as an integral function of head and approach velocity:

$$Q_T = 2(2g)^{1/2} \tan \frac{\theta}{2} \int_0^H (H-h) \left(h + \frac{V_1^2}{2g} \right)^{1/2} dh \quad (4)$$

With further development, integration defines a theoretical discharge relationship for the assumptions of ideal flow.

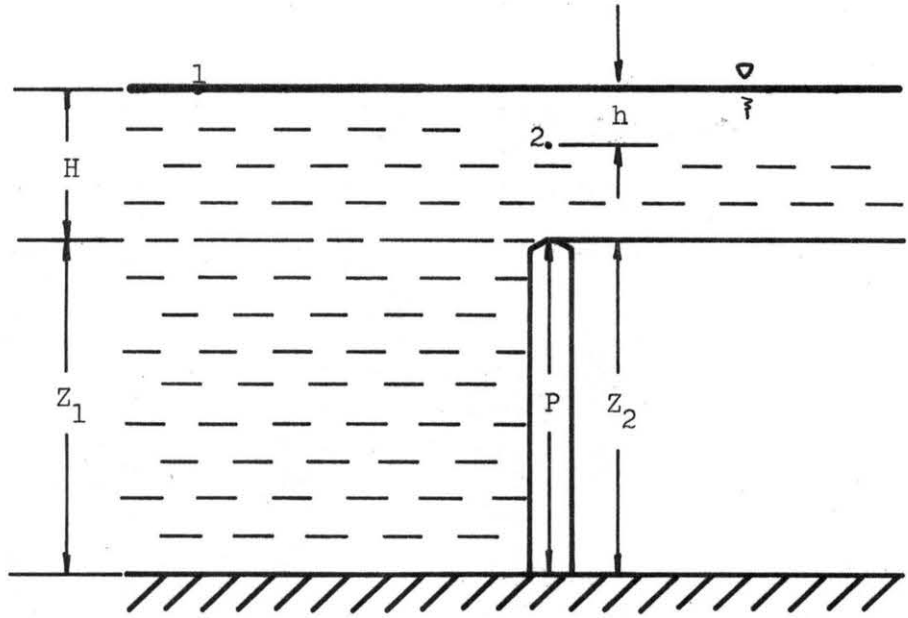

Fig. 6a - Longitudinal Cross Section of Flow

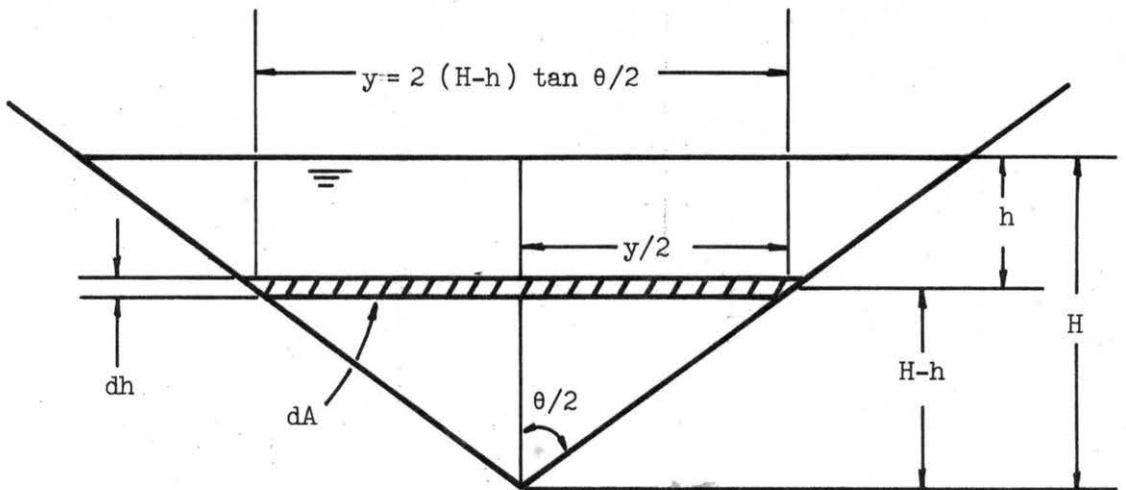

Fig. 6b - Cross Section of Triangular Weir

$$Q_T = \frac{8}{15} (2g)^{1/2} \tan \frac{\theta}{2} \left[\left(\frac{V_1^2}{2g} + H \right)^{5/2} - \left(\frac{V_1^2}{2g} \right)^{5/2} - \frac{5}{2} H \left(\frac{V_1^2}{2g} \right)^{3/2} \right] \quad (5)$$

Equation 5 provides an exact solution under the assumptions of its derivation. It defines the maximum theoretical discharge for the available total head.

Flow patterns in the field can deviate greatly from the assumptions of ideal flow. The effects of field conditions (viscous fluid and nonparallel streamlines) are normally approximated through the addition of coefficients to Equation 5.

Two coefficients are primarily associated with weir hydraulics. These coefficients are the velocity distribution coefficient, α , and the discharge coefficient, C_D .

The velocity distribution coefficient is used as a kinetic energy correction factor to account for the nonuniform velocity distribution and modifies the average velocity head term of the approaching flow, $\frac{V_1^2}{2g}$. It is defined as the ratio of the kinetic energy passing a cross section per unit time based upon the incremental velocity γv , compared to the kinetic energy flux based upon the average velocity, V .

$$\alpha = \frac{\sum \alpha v^3 \Delta A / 2g}{\alpha V^3 A / 2g} = \frac{\sum v^3 \Delta A}{V^3 A} \quad (6)$$

The second coefficient, C_D , is defined as a coefficient of discharge, which functions as a conglomerate influenced by simplifications of theory, fluid properties, and nonuniform flow patterns.

In a simplified form Equation 5 can be rewritten as,

$$Q_T = C_d g^{1/2} \tan \frac{\theta}{2} H^{5/2} \quad (7)$$

where C_d accounts for the influence of the deleted terms. Under the previously stated assumptions of ideal flow, C_d in Equation 7 is primarily a function of approach velocity head and weir geometry. For normally assumed conditions of negligible approach velocity, C_d then becomes a constant, defined by weir geometry.

The nature of C_d becomes less predictable with non ideal flow, for which many of the stated assumptions are inappropriate. Many factors can produce non uniform flow patterns upstream of the weir control. These factors can best be defined by dimensional analysis.

The important variables for two-dimensional flow over the SCS triangular broad-crested weir with aerated nappe are grouped as follows:

Boundary Variables (L, k, a, p, r, θ , ϕ , s)

Flow Variables (H, V_1)

Fluid Variables (γ , ρ , μ , σ)

where, L = weir length in the direction of flow,

k = roughness height on the weir plate surface,

a = approach channel area, measured 10 ft upstream of the weir centerline,

p = distance of weir notch above the channel bed,

r = channel roughness,

θ = internal weir angle normal to the flow $[\tan \frac{\theta}{2}]$,

ϕ = weir edge angle,

s = approach channel bed slope,

H = static head upstream of the influence of the nappe
drawdown and measured 10 ft upstream from weir centerline,

V_1 = average approach velocity,

γ = specific weight of the fluid,

ρ = fluid density,

μ = dynamic viscosity of the fluid, and

σ = surface tension of the fluid.

The variables listed can be expressed functionally as

$$0 = f(L, k, a, p, r, \theta, \phi, s, H, V_1, \gamma, \rho, \mu, \sigma) \quad (8)$$

Choosing V_1 , H , and γ as repeating variables and grouping into nondimensional parameters yields,

$$0 = f\left(\frac{L}{H}, \frac{k}{H}, \frac{a}{H^2}, \frac{p}{H}, \frac{r}{H}, \theta, \phi, s, \frac{V_1^2}{\sqrt{gH}}, \frac{\rho V_1 H}{\mu}, \frac{\rho V_1^2 H}{\sigma}\right) \quad (9)$$

where $[g = \frac{\gamma}{\rho}]$

Four parameters represent factors of weir geometry: $\frac{L}{H}$, $\frac{k}{H}$, θ , ϕ .
 Four factors represent channel characteristics: $\frac{a}{H^2}$, $\frac{p}{H}$, $\frac{r}{H}$, s , and
 three factors evolve around the mechanics of flow: $\frac{V_1^2}{\sqrt{gH}}$, $\frac{\rho V_1 H}{\mu}$, $\frac{\rho V_1^2 H}{\sigma}$.
 The three flow parameters are recognized as forms of the Froude,
 Reynolds and Weber numbers, respectively. The coefficient of discharge
 can be obtained by combining $\frac{a}{H^2}$ and $\left(\frac{V_1}{\sqrt{gH}}\right)$ and using $\tan \theta$ to form
 $Q/(g^{1/2} \tan \theta H^{5/2})$ where $[Q = av]$. Transferring C_d to the other side
 of Equation 9 and substituting C_d for $Q/(g^{1/2} \tan \theta H^{5/2})$, allows it
 to be equated as a function of the following nondimensional parameters.

$$C_d = f \left(\frac{L}{H}, \frac{k}{H}, \frac{a}{H^2}, \frac{p}{H}, \frac{r}{H}, \phi, s, R_e, W_e \right) \quad (10)$$

For the purposes of this report the number of terms in Equation 10
 can be reduced by briefly considering the nature of the nondimensional
 parameters.

The term, $\frac{L}{H}$, depicts the progression of flow patterns discussed in
 Chapter II which characterize broad-crested weirs in general. Although
 several models at different scales were tested, the crest length always
 corresponded to a single prototype crest length. In effect, this caused
 the geometric ratio, $\frac{L}{H}$, to be a constant for the different models.
 In connection with $\frac{L}{H}$, only at very high values of $\frac{L}{H}$ do the parameters
 $\frac{k}{H}$, R_e , W_e exert a level of significant influence in most field studies.
 Similarly, when defining C_d as a function of either weir roughness
 or the Reynolds number, concern is generally restricted to low heads
 (outside the scope of this study) where the boundary layer thickness is
 significant.

The third parameter accountable at high values of $\frac{L}{H}$ is a form of the Weber number: a ratio of surface tension forces to inertial forces. As such it has an insignificant effect except at very low heads where surface tension becomes a factor in the flow dynamics.

The tests were designed to avoid low heads in the models. Flow conditions yielding low heads were subsequently tested under full-scale conditions.

The parameter ϕ appears in Equation 10 as a constant. As a dimensionless quantity it is independent of the head for a fixed weir geometry. For the purposes of investigating the calibration of a specific weir geometry the term can be deleted.

A revised form of Equation 10 can then be written as,

$$C_d = f \left(\frac{a}{H^2}, \frac{p}{H}, \frac{r}{H}, s \right) \quad (11)$$

Channel Area

The results of tests conducted on 2:1 and 3:1 weirs by Ruff et al. (1977) showed calibration effects attributed to approach channel area, a . In general these tests showed two relations. First, smaller channels with low values of $\frac{a}{H^2}$ produced higher velocities than larger channels with the same value of $\frac{a}{H^2}$. Secondly, as a increased relative to H a decrease in discharge is apparent. This can be seen by considering the limit as $\frac{a}{H^2}$ approaches infinity. At the upper limit, the channel can be considered as a large upstream reservoir. As an infinite reservoir the approach velocity is negligible and the nonuniformity

of flow is minimized. As a result, the influence of channel area on C_d is expected to be inversely related to $\frac{a}{H^2}$.

Distance from Bed to Weir

Reasoning similar to that used for channel geometry can be applied to predict the general effect of bed elevation relative to the weir notch on C_d . As the distance, p , approaches infinity, the volume of water under control of the weir increases resulting in lower approach velocities and a total head line becoming asymptotic to a horizontal line. Therefore, the expected effect of bed elevation on C_d is inversely related to p/H .

The relationship can also be considered by using the momentum principle. Chow (1959) illustrates the effect of bed elevation on C_d by applying the momentum equation to a simplified two-dimensional flow over a broad-crested weir. The coefficient C_d was found to decrease with increasing values of p/H . The resultant effect indicates for a given head, H , an increase in p would result in a decrease in discharge.

Channel Roughness

The channel roughness of a natural stream may vary greatly over a short reach. Channel roughness may also vary at a cross section with changes in time, stage and sediment load. Several parameters, such as the Manning "n" and the Chezy "C" have been developed to express generalized channel resistance in terms of surface roughness. Natural channels normally exhibit conditions of a hydraulically rough surface. As such the channel roughness influences the velocity distribution and the slope of the total head line.

A comparison of the ideal flow patterns underlying the theoretical development of the discharge equation to the patterns of boundary flow suggest the effect of $\frac{r}{H}$ on C_d . The theoretical discharge, Equation 7, was developed independently of channel roughness by assuming an inviscid fluid. As such the fluid could not support turbulent shear; i.e., no effect of $\frac{r}{H}$ on C_d . Similarly, for very small values of $\frac{r}{H}$, the laminar sublayer produces a hydraulically smooth surface which indicates a minimum effect of $\frac{r}{H}$ on C_d .

Channel Bed Slope

Increasing approach channel bed slope leads to both nonuniform flow and greater approach velocities. A sloping channel bed directly adds to the nonuniformity of flow under the assumption of a horizontal water surface within the reach of weir control. Also, due to a steeper upstream hydraulic grade line, higher approach velocities often occur in the channel, resulting in a significant velocity gradient over the length of weir controlled flow. As a result, the coefficient of discharge is expected to show an increase with steepening approach channel bed slope.

Chapter IV
MODEL TESTS

Of the four approach channel parameters identified in Equation 11, three were chosen as components of the model testing. Channel roughness was deleted as it was considered beyond the capability of the modeling effort.

The channel geometries studied in the 1977 CSU tests (Ruff et al.) of the SCS broad-crested V-notch weir were modeled in part from the previous work of Huff (1938, 1941a, 1941b, 1942) and from field installations. Generally the trapezoidal channel geometries modeled in the 1977 study were similar to the type of channel used in the original testing carried out by Huff. In contrast, the circular channel cross sections tested were selected to approximate approach channels of USDA-ARS broad-crested V-notch weir flow metering stations near Treynor, Iowa. The channel cross sections chosen for additional testing and reported herein broaden the scope of available weir calibrations for generalized approach channel conditions.

The 1976 weir calibration tests conducted by Dang which utilized only 5:1 scale models with 45 ft (model) of approach channel were expanded to include weir models with scale ratios of 1:1, 2.5:1, 5:1 and 10:1. Models were constructed with 90 ft (model) of approach channel. As with the 1976 study, models were constructed in the 4 ft x 8 ft x 200 ft recirculating flume at the CSU Engineering Research Center. The flume tilts with a 2 percent maximum slope and has a orifice calibrated discharge range of 0.05 cfs to 30 cfs.

The 5:1 scale weir plates were constructed of aluminum stock. Weir plate materials for the model scales of 1:1, 2.5:1, and 10:1 were selected based on the ease of construction. The large scale weir plates, 1:1 and 2.5:1, were constructed of laminated wood and coated with an epoxy paint. The 10:1 scale weir plates were cut out of plexiglass and milled to the correct dimensions.

Round bottom triangular channels, designated as circular, and trapezoidal channels of various cross sections were constructed of sand and surfaced with a thin cement mortar. An integrated intake was constructed flush with the channel bed at a distance of 10 ft (prototype) upstream of the weir centerline to measure the average head over the cross section. The integrated intake was connected to the stilling well and consisted of a box like structure with an iron band covering the top and which served as an intake surface. The iron band was fabricated to conform to the shape of the different channel cross sections. Oblong slots approximately 0.5 inch by 2 inch and separated by 3 inches were cut into the band to permit the entrance of water. Two secondary head measurements were taken using piezometer taps located at positions immediately upstream of the weir face and 10.0 ft (model) upstream of the weir centerline.

The integrated intake and piezometers were connected to a selective multiple input stilling well located on the outside wall of the flume adjacent to the weir centerline. The stilling well was free to pivot about a point on the weir notch zero elevation line such that no correction for flume slope was required. A hook gage mounted on the stilling well was used to obtain static head measurements. The hook gage could be read to the nearest 0.001 ft.

Three weir geometries were tested in combination with the channel shapes. Weir side slopes of 2 to 1 ($\theta = 127^\circ$), 3 to 1 ($\theta = 143^\circ$), and 5 to 1 ($\theta = 157^\circ$) were utilized. For each weir angle the elevation of the center of the weir notch was defined as the zero datum. Conditions describing zero bed elevation are shown in Figure 7. The upstream channel bed was maintained at 1.5 ft (model) above the downstream channel bed to provide adequate drop to insure against weir submergence. Negative bed elevations were achieved by raising the weir. Bed elevations of 0.0 ft, -0.5 ft, -1.0 ft, and -1.5 ft were generally tested. All channels tested at 0.0 ft bed elevation were run at the following four channel slopes: 0.0, 0.5, 1.0, and 1.5 percent.

During some calibration runs, velocity and water surface profile measurements were conducted at flows approximately 25 and 75 percent of the expected discharge ranges. Surface readings were taken at positions along the channel centerline and 2.0 ft (model) to either side of centerline as shown in Figure 8. Surface readings were used as comparisons to still well values and as indicators of the presence of standing waves.

In conjunction with the surface readings, point velocities were measured at the channel cross section over the integrated intake, using an Ott current meter. The Ott meter was positioned in a cross sectional grid of 0.5 ft horizontal to 0.1 ft vertical (model). Velocity measurements were taken at the grid nodal points (refer to Dang, 1976). Velocities were used to construct isovels for computation of α values representative of the test conditions.

The model test program results were correlated by run number and a run characteristics code. Test conditions are coded by weir type,

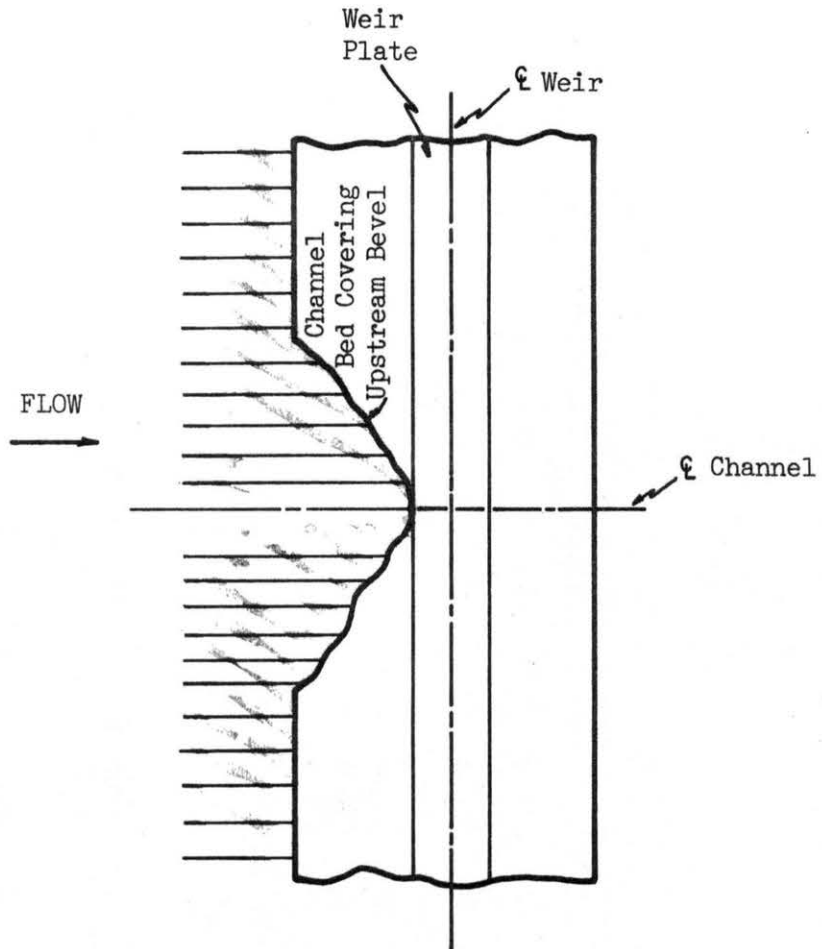

PLAN VIEW

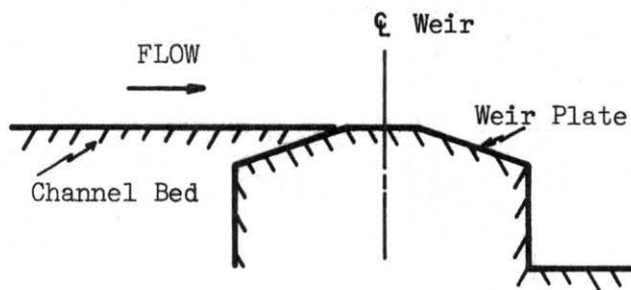
CROSS SECTION
ALONG ϵ OF CHANNELFig. 7 - Description of Zero Bed
Elevation

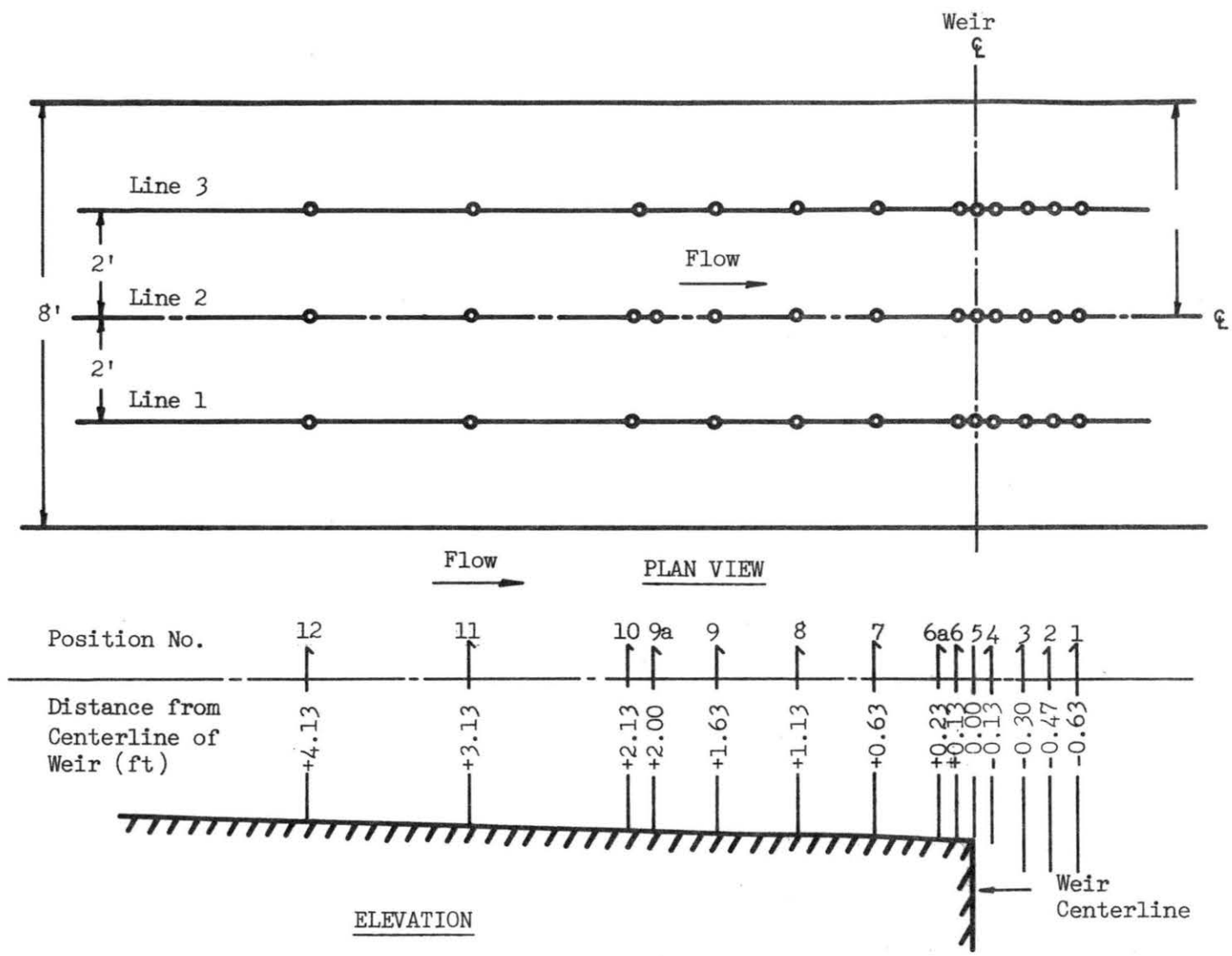

Fig. 8 - Water Surface Profile Measurement Positions

percent channel slope, channel type, and model scale.

Weir types are abbreviated as:

W1 = 3:1 side slope weir

W2 = 2:1 side slope weir

W3 = 5:1 side slope weir

Channel type designations define test conditions by channel form and bed elevation. Channel forms are generalized as circular, "C", or trapezoidal, "T". Bed elevations are presented as negative values defining the channel elevation upstream from the weir in feet below the weir notch.

The following example illustrates the use of model test coding.

W1/0.5/C-0.18/5:1

where;

W1 = 3:1 side slope weir

0.5 = percent channel slope

C-0.18 = circular channel with the channel bed -0.18 ft (model) below
the weir notch

5:1 = model scale of testing

Table 2 cross references the model testing by run number, test conditions coding, channel bottom dimension, and the approach channel side slope.

The channel bottom dimension is the bed width for a trapezoidal channel or is the radius of the circular section forming the bed that is tangent to the channel side slopes. The weirs and channels tested are shown in Figure 9.

2:1 WEIR

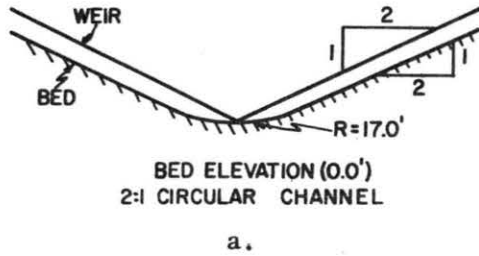

3:1 WEIR

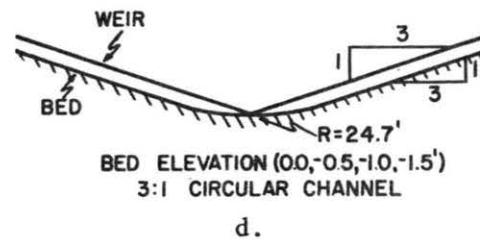

5:1 WEIR

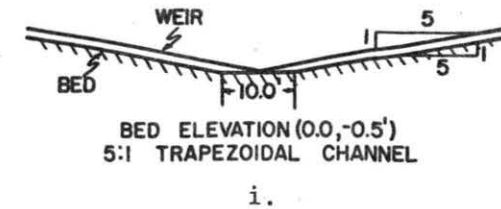
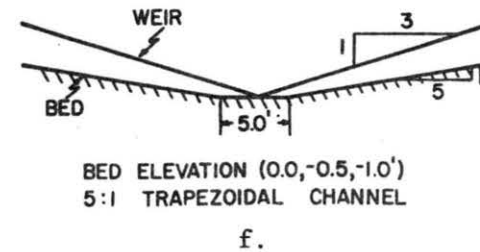
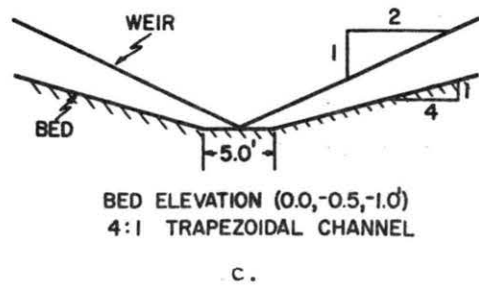
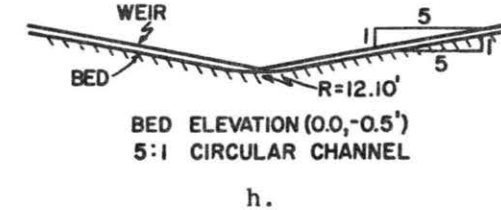
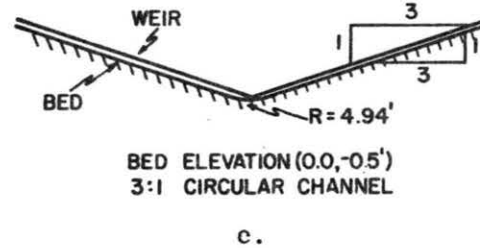
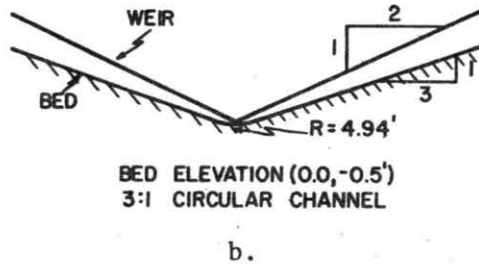
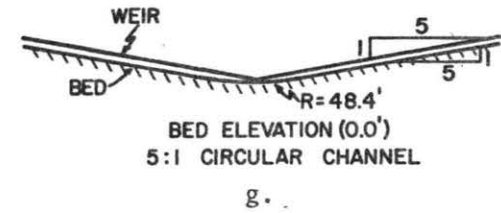

Fig. 9 - Channel Cross Sections Tested

2:1 Weir Tests

Circular channels built at a 1:1 scale ratio and a trapezoidal channel built at a 5:1 scale ratio were tested in conjunction with the 2:1 slope broad-crested V-notch weir (see Table 2).

The aim of the full-scale testing was to increase the accuracy of the calibrations at low flows. The tests encompassed flows for heads of less than 1.5 ft. The circular channel geometry, Figure 9b, was constructed with a bottom radius of 4.94 ft and 3:1 side slopes. To minimize channel construction the circular approach channel geometry was chosen to enable its use for both 2:1 weir and 3:1 weir tests.

A second series of tests with the 2:1 weir was also conducted. Tests were performed at a 1:1 scale with 15 feet of the channel upstream of the weir modified with a 17 ft radius and 2:1 side slopes (see Figure 9a). The channel is similar to channels test by Dang (1976). The larger channel geometry (17.0 ft radius) allowed for calibration comparisons with both the narrower (4.94 ft radius) channel tests and previous tests performed by Dang. The 2:1 weir was also tested with the trapezoidal approach channel with 4:1 side slopes and a 5.0 ft bottom width shown in Figure 9c. The channel geometry was chosen as representative of a wide trapezoid channel used with the 2:1 weir. Calibration tests conducted with the 5 ft trapezoid channel allow weir rating comparisons with the previous studies conducted by Huff (1941a) and Dang (1976) on narrower trapezoidal cross sections.

3:1 Weir Tests

Full-scale circular channels and 5:1 scale trapezoidal channels, similar to the 2:1 weir channels test, were tested in conjunction with

TABLE 2

Chart of Calibration Tests

Run No.	Testing Code	Channel Bottom (ft) (radius or width)	Channel Side Slope
1	W1/0.00/C-.18/5:1	24.70	3:1
2	W1/0.25/C-.18/5:1	24.70	3:1
3	W1/0.05/C-.18/5:1	24.70	3:1
4	W1/0.75/C-.18/5:1	24.70	3:1
5	W1/1.00/C-.18/5:1	24.70	3:1
6	W1/1.50/C-.18/5:1	24.70	3:1
7	W1/0.50/C-.70/5:1	24.70	3:1
8	W1/0.50/C-1.23/5:1	24.70	3:1
9	W1/0.50/C-1.76/5:1	24.70	3:1
10	W1/0.00/C-.18/1:1	4.94	3:1
11	W1/0.50/C-.18/1:1	4.94	3:1
12	W1/1.00/C-.18/1:1	4.94	3:1
13	W1/1.50/C-.18/1:1	4.94	3:1
14	W1/0.00/C-.68/1:1	4.94	3:1
15	W1/0.50/C-.68/1:1	4.94	3:1
16	W1/1.00/C-.68/1:1	4.94	3:1
17	W1/1.50/C-.68/1:1	4.94	3:1
18	W2/0.00/C-.19/1:1	4.94	3:1
19	W2/0.50/C-.19/1:1	4.94	3:1
20	W2/1.00/C-.19/1:1	4.94	3:1
21	W2/1.50/C-.19/1:1	4.94	3:1
22	W2/0.00/C-.68/1:1	4.94	3:1
23	W2/0.50/C-.68/1:1	4.94	3:1
24	W2/1.00/C-.68/1:1	4.94	3:1
25	W2/1.50/C-.68/1:1	4.94	3:1
26	W2/0.00/C-0.0/1:1	17.00	2:1
27	W2/0.50/C-0.0/1:1	17.00	2:1
28	W2/1.00/C-0.0/1:1	17.00	2:1
29	W2/1.50/C-0.0/1:1	17.00	2:1
30	W1/0.00/T-0.0/5:1	5.00	5:1
31	W1/0.05/T-0.0/5:1	5.00	5:1
32	W1/1.00/T-0.0/5:1	5.00	5:1
33	W1/1.50/T-0.0/5:1	5.00	5:1
34	W1/0.50/T-0.50/5:1	5.00	5:1
35	W1/0.50/T-1.00/5:1	5.00	5:1
36	W2/0.00/T-0.0/5:1	5.00	4:1
37	W2/0.50/T-0.0/5:1	5.00	4:1
38	W2/1.00/T-0.0/5:1	5.00	4:1
39	W2/1.50/T-0.0/5:1	5.00	4:1
40	W2/0.50/T-0.50/5:1	5.00	4:1
41	W2/0.50/T-1.00/5:1	5.00	4:1
42	W5/0.00/T-0.0/10:1	10.00	5:1
43	W5/0.50/T-0.0/10:1	10.00	5:1
44	W5/1.00/T-0.0/10:1	10.00	5:1

TABLE 2 Continued

Chart of Calibration Tests

Run No.	Testing Code	Channel Bottom (ft) (radius or width)	Channel Side Slope
45	W5/1.50/T-0.0/10:1	10.00	5:1
46	W5/0.00/T-0.50/10:1	10.00	5:1
47	W5/0.50/T-0.50/10:1	10.00	5:1
48	W5/1.00/T-0.50/10:1	10.00	5:1
49	W5/1.50/T-0.50/10:1	10.00	5:1
50	W5/0.00/C-0.0/10:1	48.40	5:1
51	W5/0.50/C-0.0/10:1	48.40	5:1
52	W5/1.00/C-0.0/10:1	48.40	5:1
52	W5/1.50/C-0.0/10:1	48.40	5:1
54	W5/0.00/C-0.0/2.5:1	12.10	5:1
55	W5/0.50/C-0.0/2.5:1	12.10	5:1
56	W5/1.00/C-0.0/2.5:1	12.10	5:1
57	W5/1.50/C-0.0/2.5:1	12.10	5:1
58	W5/0.00/C-0.50/2.5:1	12.10	5:1
59	W5/0.50/C-0.50/2.5:1	12.10	5:1
60	W5/1.00/C-0.50/2.5:1	12.10	5:1
61	W5/1.50/C-0.50/2.5:1	12.10	5:1

the 3:1 weir. Channel slopes and bed elevations for both the circular and trapezoidal channels were tested as for the 2:1 weir and are outlined in Table 2. Channel geometries used in conjunction with the 3:1 weir are shown in Figures 9d, 9e, 9f. The full scale circular channel, used for low head calibration, was constructed with a radius of 4.94 ft. The channel radius was chosen as it allowed for greater versatility in the testing program. The trapezoid channel was constructed with a bottom width of 5.0 ft and 5:1 side slopes (Figure 9f). The geometry of the trapezoidal channel was selected to define the weir discharge calibration curves for wide approach channel conditions.

In addition to the established testing program for the 2:1 and 3:1 weirs, a series of control tests was also run with the 3:1 weir to duplicate tests conducted by Ruff, Dang, and Saxton (1976). Additional tests at the 5:1 scale were conducted using the previously described circular approach channel (Figure 9d) to duplicate the tests of Ruff et al. At a 5:1 scale the channel radius, 24.7 ft, was the same as the circular channel tested by Dang. Runs at the four bed slopes were conducted to duplicate the circular channel calibration tests conducted by Dang. Two additional bed slopes of 0.25 and 0.75 percent were also tested for comparison.

5:1 Weir Tests

Three channel cross sections were tested using the 5:1 weir. These included a trapezoidal and two circular channel cross sections.

The trapezoidal cross section, shown in Figure 9i, was tested using a 10:1 model scale. The trapezoidal cross section was constructed with a bottom width of 10 ft (prototype) and 5:1 side slopes. Tests were

run at the four bed slopes of 0.0, 0.5, 1.0 and 1.5 percent with bed elevations of 0.0 ft and -0.5 ft.

Tests were performed at the 10:1 and 2.5:1 scales with the circular channel shape. The same channel was used for testing both model scales. The 10:1 scale circular channel as shown in Figure 9g had a bottom radius of 48.4 ft and 5:1 side slopes. Using the larger 2.5:1 model scale the bottom radius of the channel was reduced to 12.1 ft.

Chapter V

DATA SUMMARIES

Individual test results are presented in the appendices. Figure numbers within the appendices correspond to the run numbers of Table 2.

Tables A-1 to A-61 of Appendix A give the tabulated test data. All prototype head values represent flow conditions at a cross section 10 ft (prototype) upstream of the weir centerline. Data are given for:

1. Q_M = model discharge, cfs
2. Q_P = prototype discharge, cfs
3. H_M = model static head, ft
4. H_P = prototype static head, ft
5. A_P = prototype flow cross-sectional area, ft^2
6. V_P = mean prototype velocity at station 10 ft upstream from weir centerline, ft/sec
7. H_V = velocity head, $(V_1^2/2g)$, ft
8. H_T = total head, ft ($H_T = H_P + \alpha H_V$, $\alpha = 1.116$)
9. Y_N = prototype normal depth of flow, ft
10. Y_C = prototype critical depth of flow, ft
11. F = Froude number, $(V_P/[g A_P/\alpha T])^{0.5}$; where T = water surface width)
12. C_d = discharge coefficient

Calibration curve data for static head versus discharge are plotted on logarithmic scales in Figure A-1 to A-61, Appendix A. The static head values reflect stilling well readings in feet. The corresponding discharges which were modeled by the Froude criterion from orifice measured

flows in the model are given in cubic feet per second. All plotted results are presented in prototype dimensions. Data points are shown for both subcritical and supercritical flow conditions in the approach channels. Data points depicting supercritical flow are set apart from the weir controlled flow data by using solid symbols. The calibration curves and equations presented reflect a least squares regression fit on only the data indicating weir control (see Tables A-1 to A-61). Data plots reflecting largely supercritical flow conditions are given without calibration curves.

Total head is plotted against discharge in Figures B-1 to B-61, Appendix B. Total head was computed as:

$$H_T = H_P + \alpha H_V \quad (12)$$

where:

- H_T = total head
- H_P = static head
- H_V = velocity head
- α = velocity coefficient, 1.116

The value, $\alpha = 1.116$, given by Dang (1976) is an average value representative of flow conditions in his 1976 broad-crested V-notch weir study. The sampling of velocity distributions conducted under this study was generally representative of Dang's average value. The testing reflected values between 1.006 and 1.183, giving an average of 1.120. Both subcritical

and supercritical data points are shown on the total head data plots with only those describing subcritical flow over the integrated intake considered in the weir calibrations.

Linear scale data plots of total head versus discharge coefficient (C_d) are shown in Figures C-1 to C-61, Appendix C. Only the data points representing subcritical flow approaching the weir are shown. Total head is plotted in feet of water and C_d is a non-dimensional parameter. The discharge coefficient derived from Equation (7) given previously was calculated by:

$$C_d = Q_p / [\tan \frac{\theta}{2} (g)^{.5} (H_T)^{2.5}] \quad (13)$$

where:

Q_p = Prototype Discharge

H_T = Prototype Total Head

θ = Weir internal angle

g = Acceleration of gravity

Channel Size Effects

Three channel geometries were tested and compared for each weir. To illustrate the results, tests are compared for a 0.0 ft bed elevation and 0.5 percent channel bed slope. The rating curves present a least squares analysis of the combined test runs. Head versus discharge for the different channel geometries are given in Figures 10a to 10c. The corresponding total head versus discharge comparisons are shown in Figures 11a to 11c.

2:1 Weir

Head versus discharge data from the three approach channel sizes tested with the 2:1 weir are shown in Figure 10a. The regression line using all the data shows a good correlation between the three channels. The weir ratings indicate no significant approach channel size effects for the range of channels tested. Total head data plotted in Figure 11a shows a similar compliance of calibration data.

3:1 Weir

Figure 10b shows the combined test data for the three channels constructed in connection with the 3:1 weir. A good correlation is apparent between the combined data rating curve and each of the three data runs. The total head data, Figure 11b, also conforms well to the regression curve.

5:1 Weir

Figure 10c shows the head versus discharge calibration data for the trapezoidal and two circular approach channels studied. The wide circular channel (radius 48.4 ft) and the trapezoidal channel show comparable calibration data within the range tested. The narrower circular channel (radius 12.1 ft) shows a calibration shift nearly parallel to the calibration curve drawn for the wide channels as indicated by the regression lines shown. The narrow channel weir calibration indicates nearly 30 percent larger discharge for a given head than measured using the wider approach channels.

The corresponding total head versus discharge calibration comparisons are shown in Figure 11c. The plotting of total head in place of static

head shows a closer congruity between the discharge calibrations of the three channel geometries. The total head plots shows a significant rating influence due to velocity head.

Bed Elevation Effects

Representative discharge data comparing the bed elevations tested for each weir type are presented in Figures 12 and 13. Head versus discharge graphs are shown in Figures 12a and 12d. The related plots of total head versus discharge are presented in Figures 13a to 13c. All data comparisons in Figures 12 and 13 represent 0.5 percent sloping approach channel conditions.

2:1 Weir

Discharge ratings for the 2:1 weir utilizing bed elevations of 0.0 ft, -0.5 ft, and -0.1 ft are shown in Figures 12a and 13a. The data shown were obtained using the 4:1 side slope trapezoidal approach channel. Both head and total head data graphs (Figures 12a and 13a, respectively) shows only a small effect of bed elevation (refer to Figures A-37, A-40, A-41) over the bed elevations tested. Comparison of the separate rating curves for each run indicate a slight increase in the rating curve slope and intercept as the bed elevation becomes larger.

3:1 Weir

Figure 12b shows the weir calibration data for the 3:1 side slope, trapezoidal channel at bed elevations of 0.0 ft, -0.5 ft and -1.0 ft. The 0.0 ft bed elevation test data indicates weir discharges 10 to 20 percent higher than for the lower channel beds (refer to Figures A-31,

A-35). As cited for the 2:1 weir tests, a convergence between the data is evident with increasing head. Subsequent lowering of the channel bed from -0.5 ft to -1.0 ft shows no additional decrease in the discharge data. The graph of the corresponding total head versus discharge data, Figure 13b, supports the results, indicating no apparent velocity head effect.

5:1 Weir

Comparisons of head versus discharge for bed elevations of 0.0 ft and -0.5 ft are shown in Figures 12c and 12d. Results from tests with the wide 5:1 side slope trapezoidal approach channel are shown in Figure 12c. Lowering the channel bed shows discharge decrease of up to 20 percent at the higher heads, (refer to Figures A-43, A-47).

Low head tests using the narrow, 5:1 side slope, circular approach channel at bed elevations of 0.0 ft and -0.5 ft reveal a weir rating variation near 30 percent (Figure 12d). Similar to the previously cited channel area-velocity head effect, the incorporation of a lower bed elevation reduces the influence of velocity head. Plotting total head (Figure 13c) shows improved correlation as the 0.0 ft and -0.5 ft curves tend to converge toward a single line.

Channel Slope Effect

Figures 14a - 14c illustrate weir calibration dependence on approach channel slope. Calibration curves corresponding to channel slopes of 0.5, 1.0, and 1.5 percent are shown in each figure for the 2:1, 3:1 and 5:1 weirs respectively. Weir tests with channel slopes of 0.5 percent or less generally yielded essentially congruent calibrations. Therefore,

only the 0.5 to 1.5 percent channel slopes are used for comparison purposes. Tests involving channel slopes in excess of 0.5 percent normally revealed considerable data fluctuation and drift in contrast to the nearly linear weir rating curves associated with milder channel slopes.

The corresponding total head versus discharge graphs are shown in Figures 15a - 15c. The addition of velocity head to the calibration ratings generally cause a convergence of data for the channel slope tested.

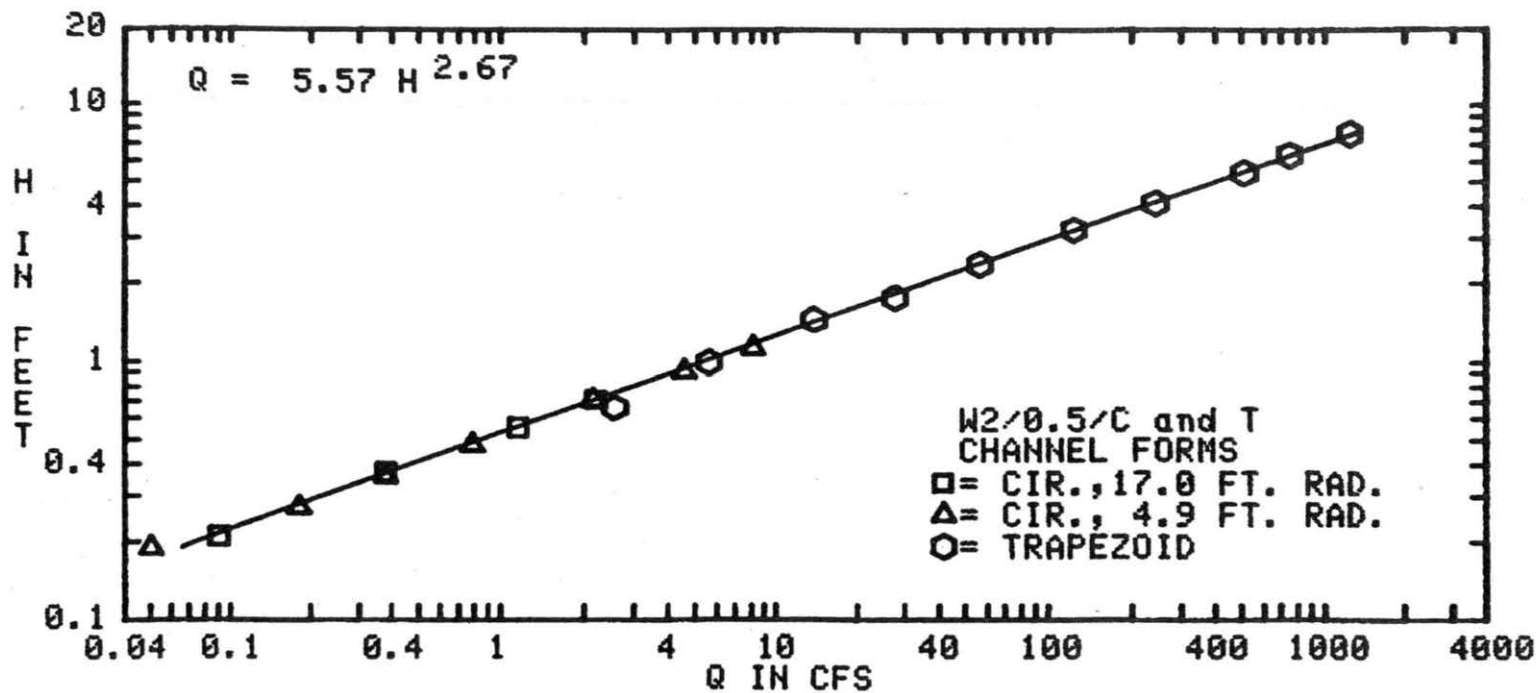

FIG. 10a PLOT OF HEAD versus DISCHARGE DATA POINTS

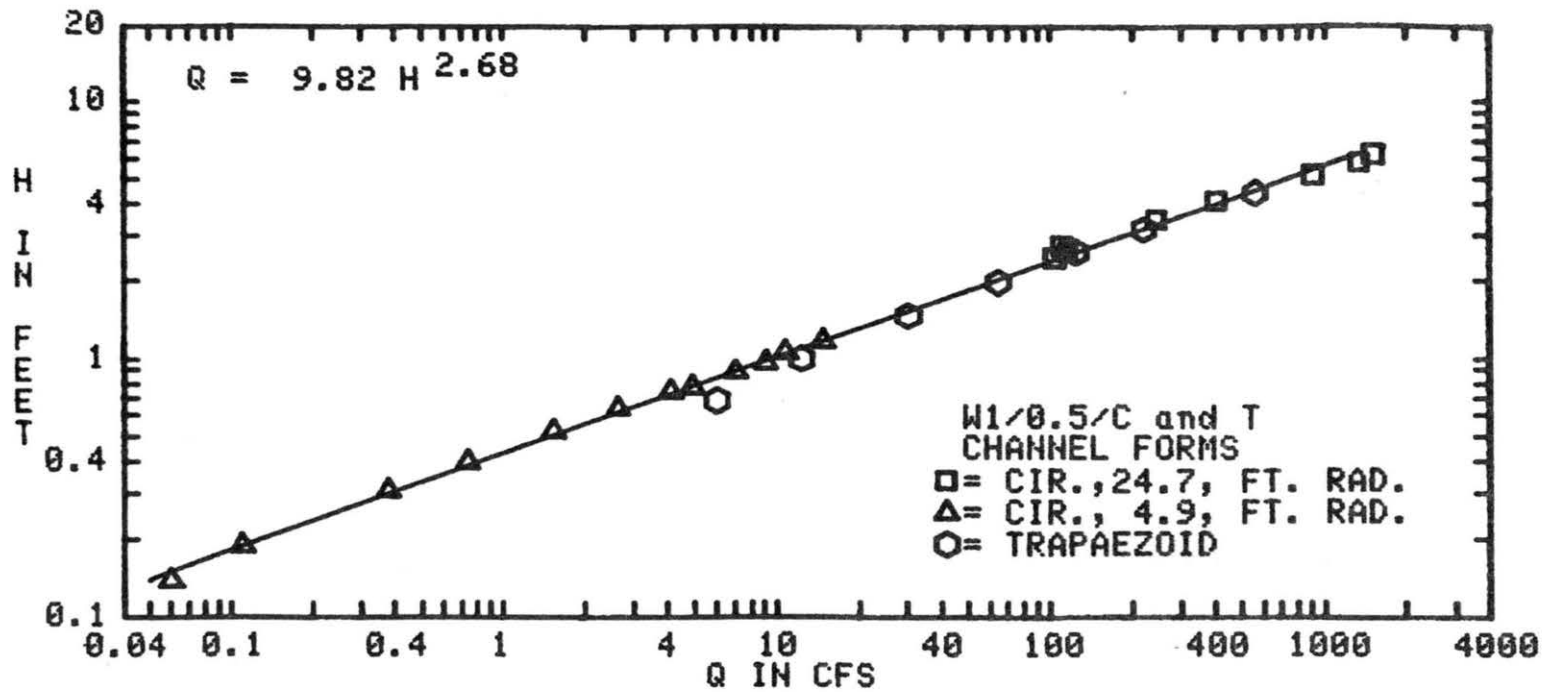

FIG. 10b PLOT OF HEAD versus DISCHARGE DATA POINTS

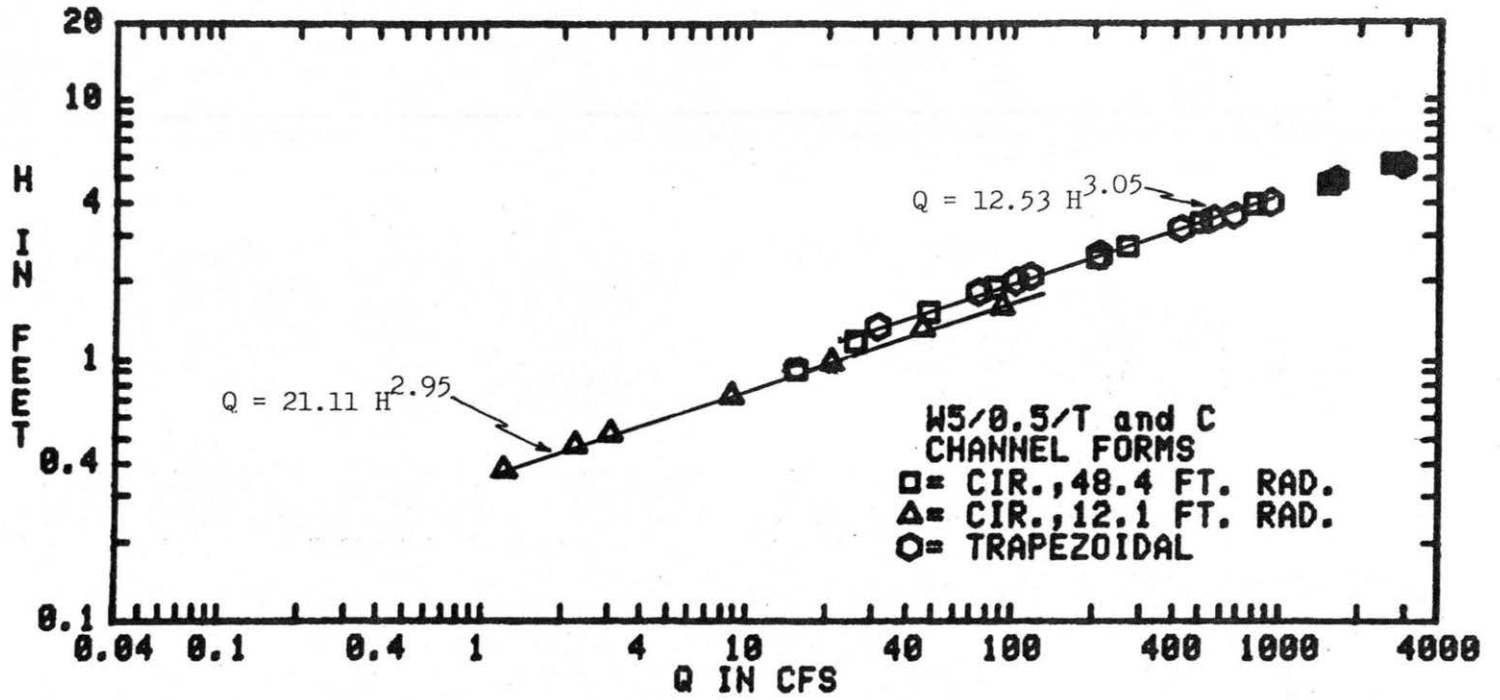

FIG. 10c PLOT OF HEAD versus DISCHARGE DATA POINTS

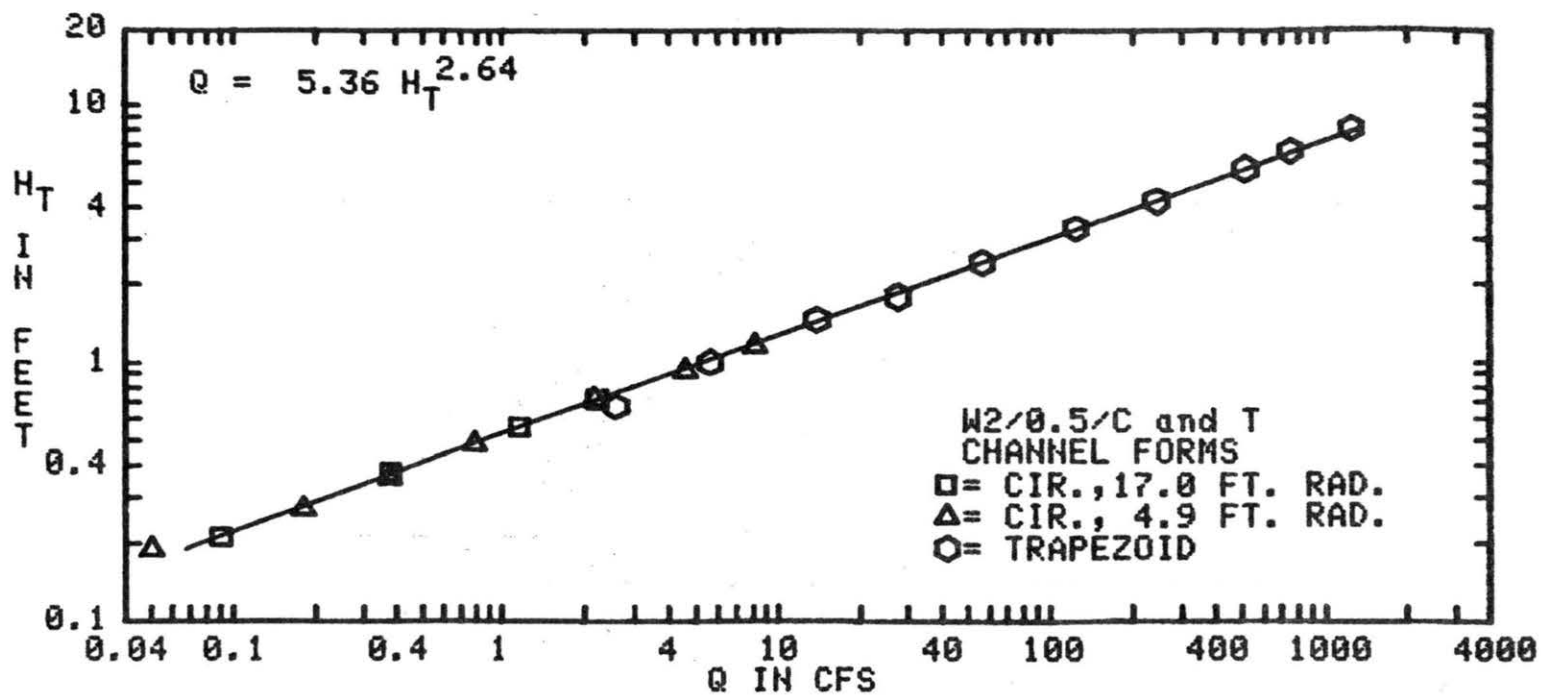

FIG. 11a PLOT OF TOTAL HEAD versus DISCHARGE DATA POINTS

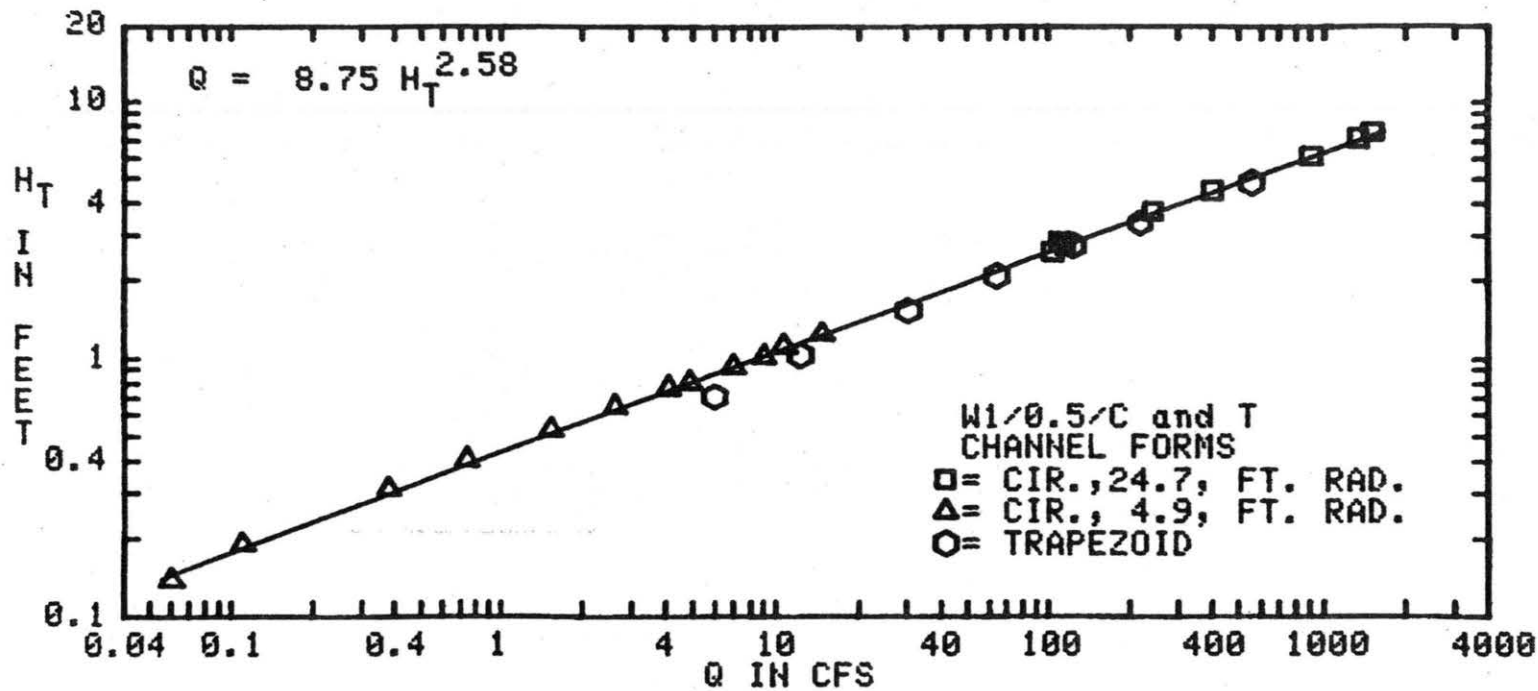

FIG. 11b PLOT OF TOTAL HEAD versus DISCHARGE DATA POINTS

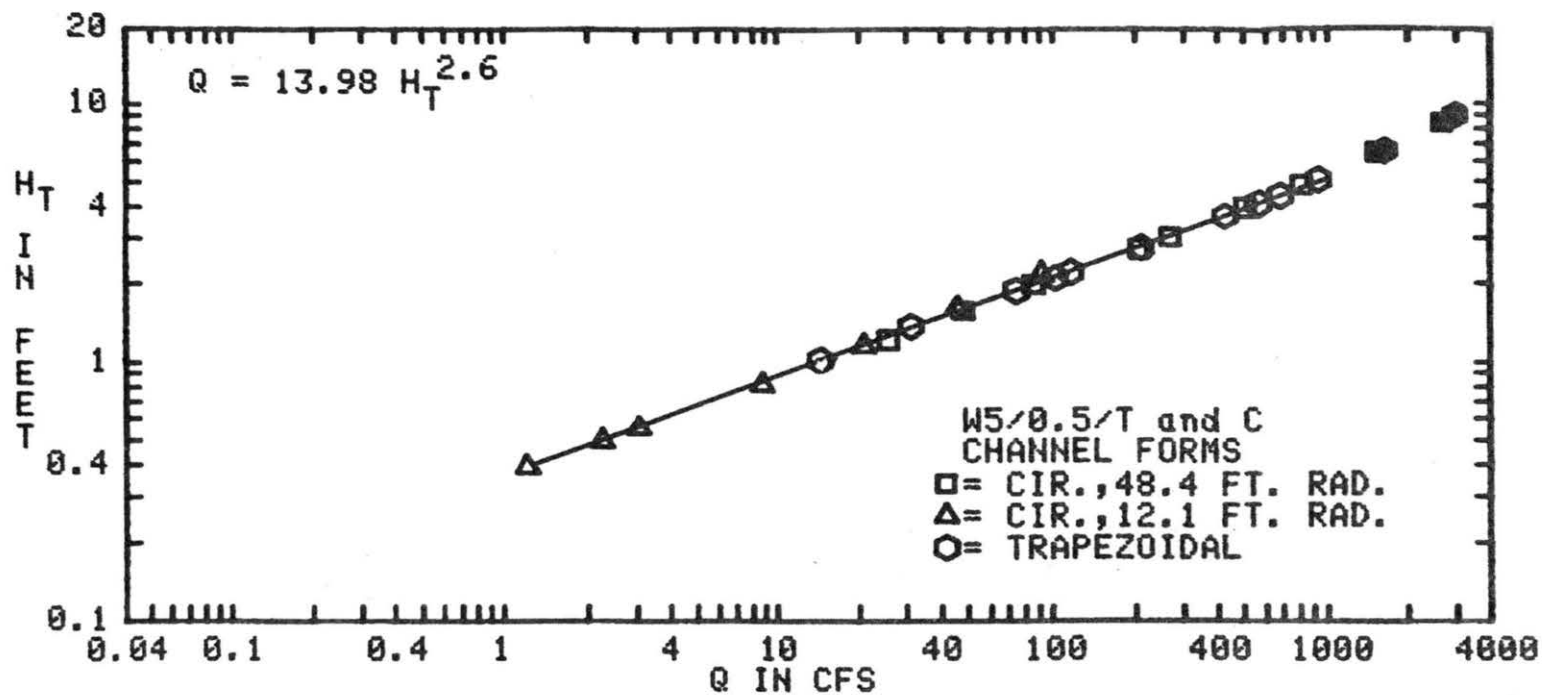

FIG. 11c PLOT OF TOTAL HEAD versus DISCHARGE DATA POINTS

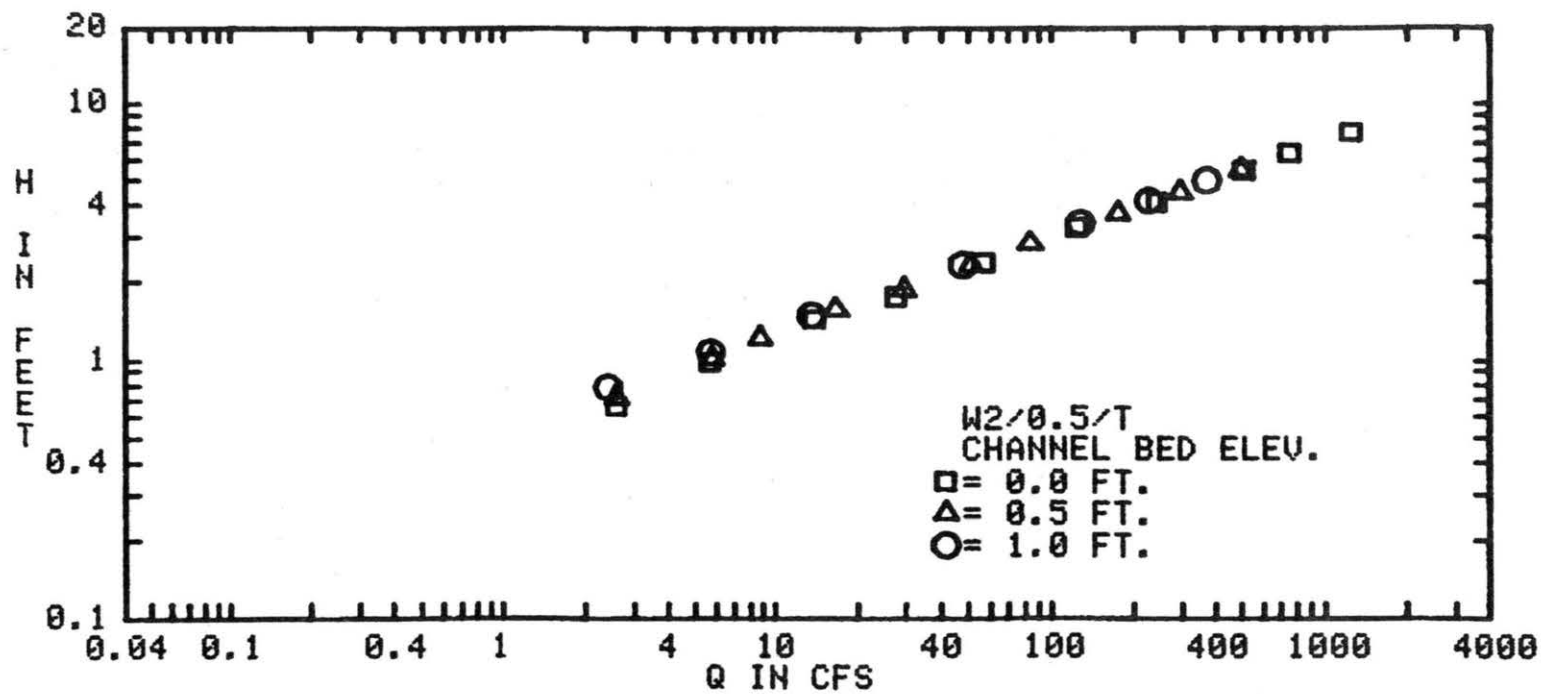

FIG. 12a PLOT OF HEAD versus DISCHARGE DATA POINTS

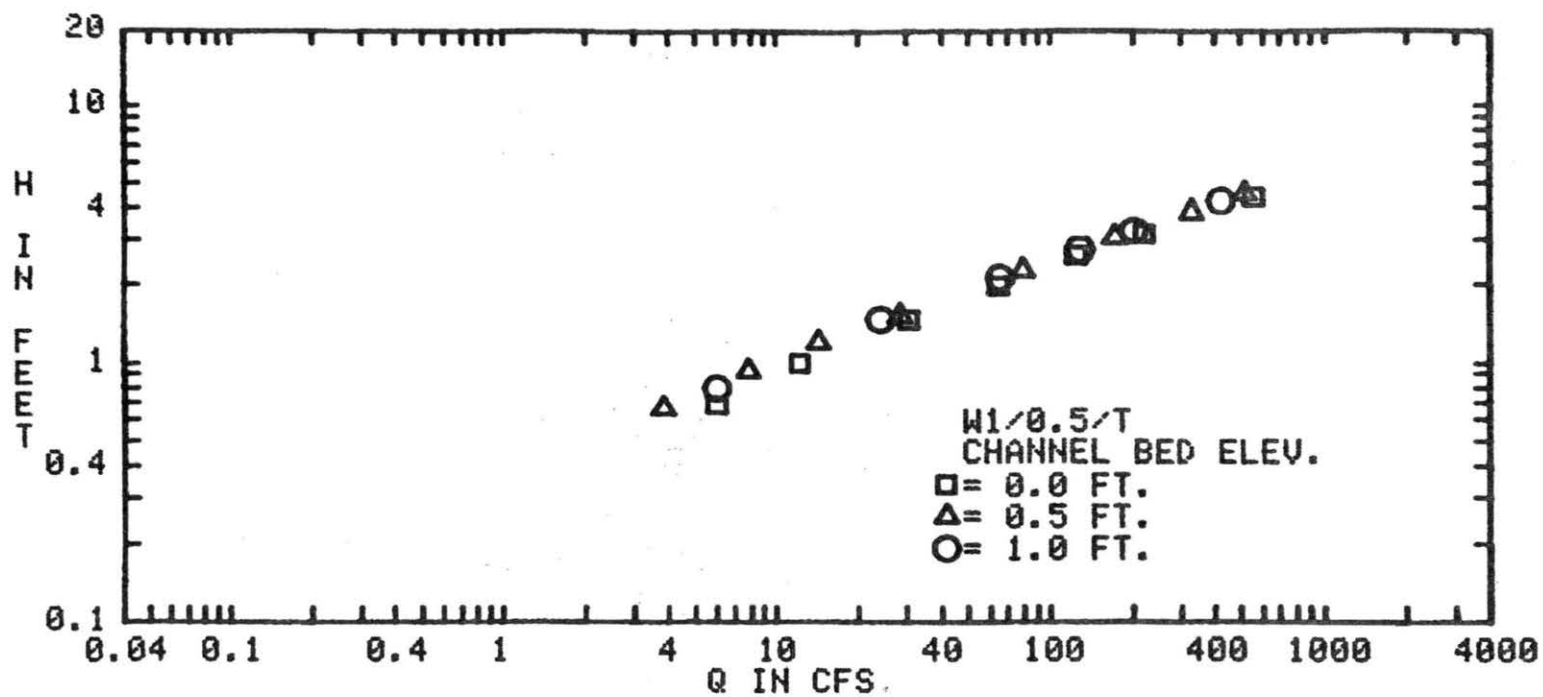

FIG. 12b PLOT OF HEAD versus DISCHARGE DATA POINTS

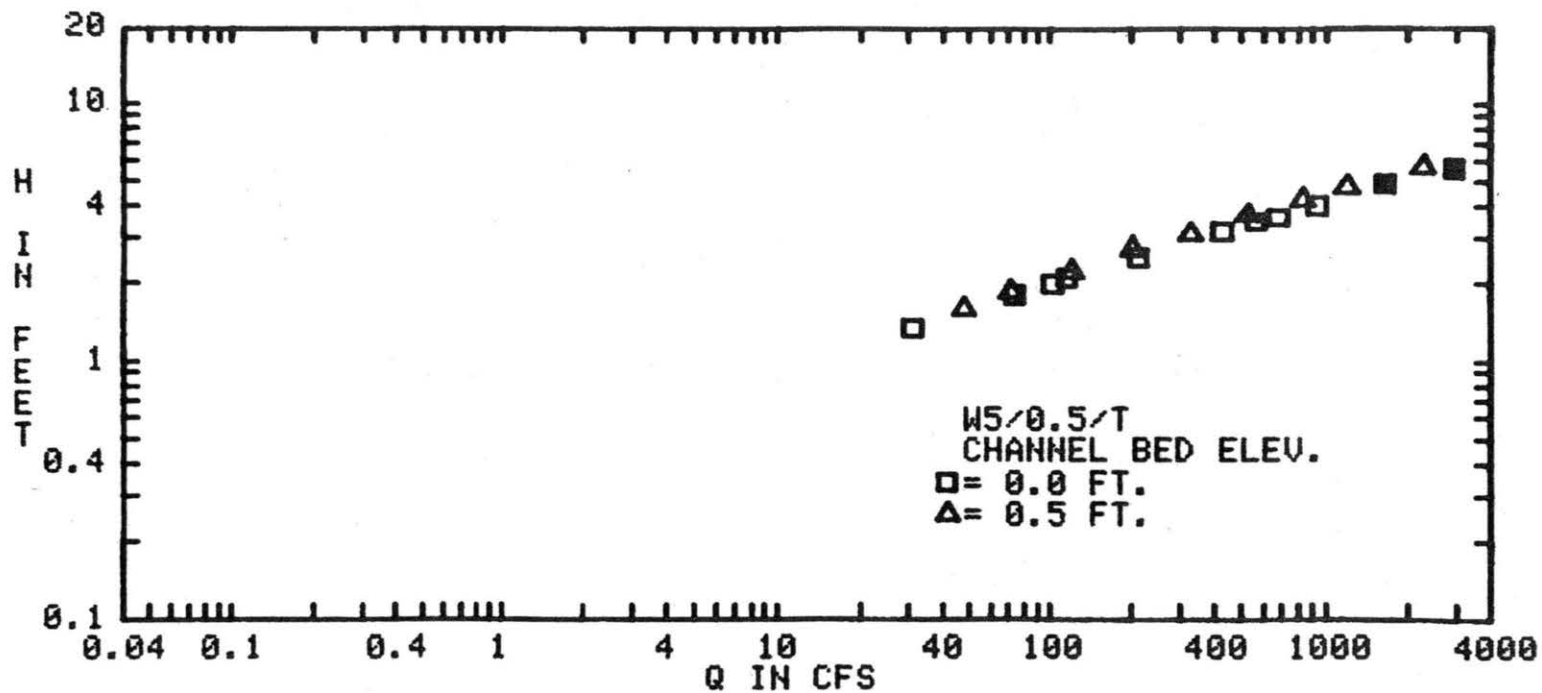

FIG. 12c PLOT OF HEAD versus DISCHARGE DATA POINTS

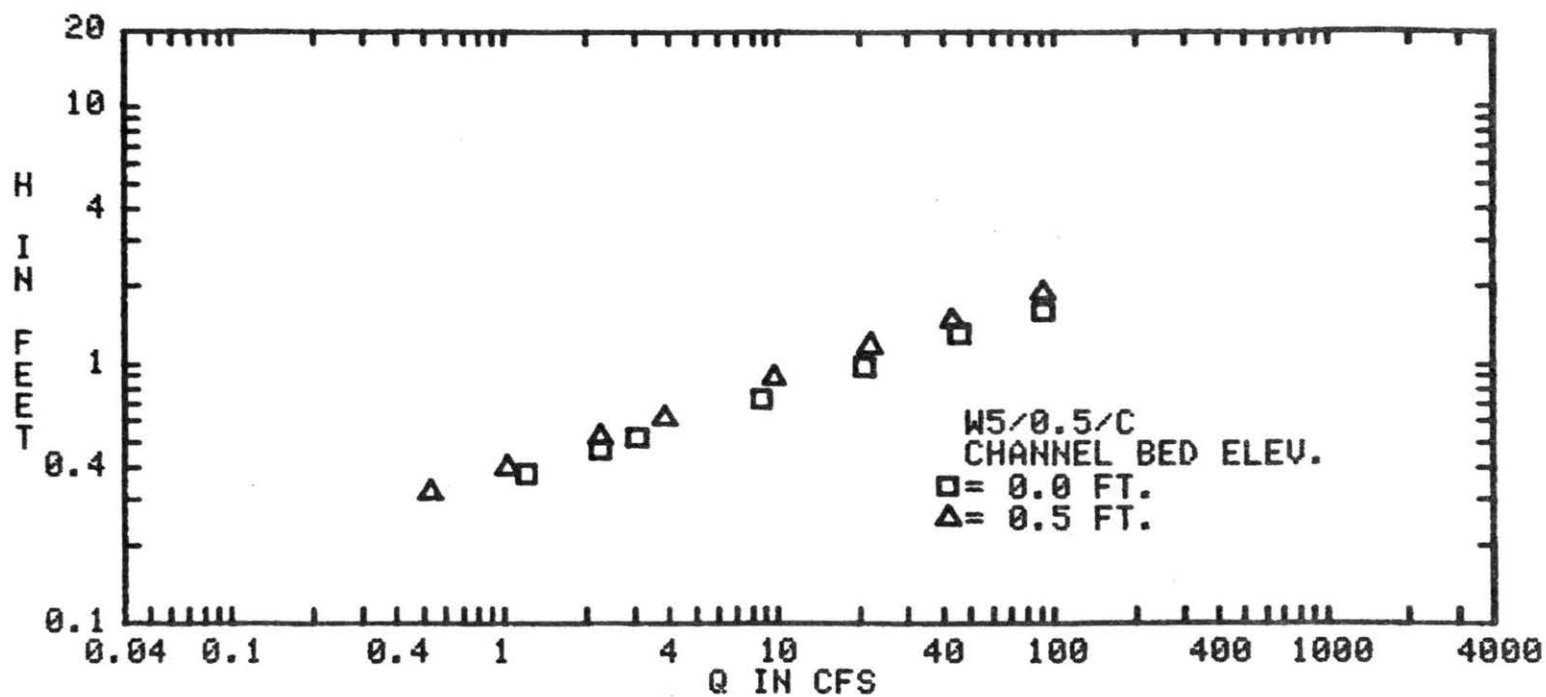

FIG. 12d PLOT OF HEAD versus DISCHARGE DATA POINTS

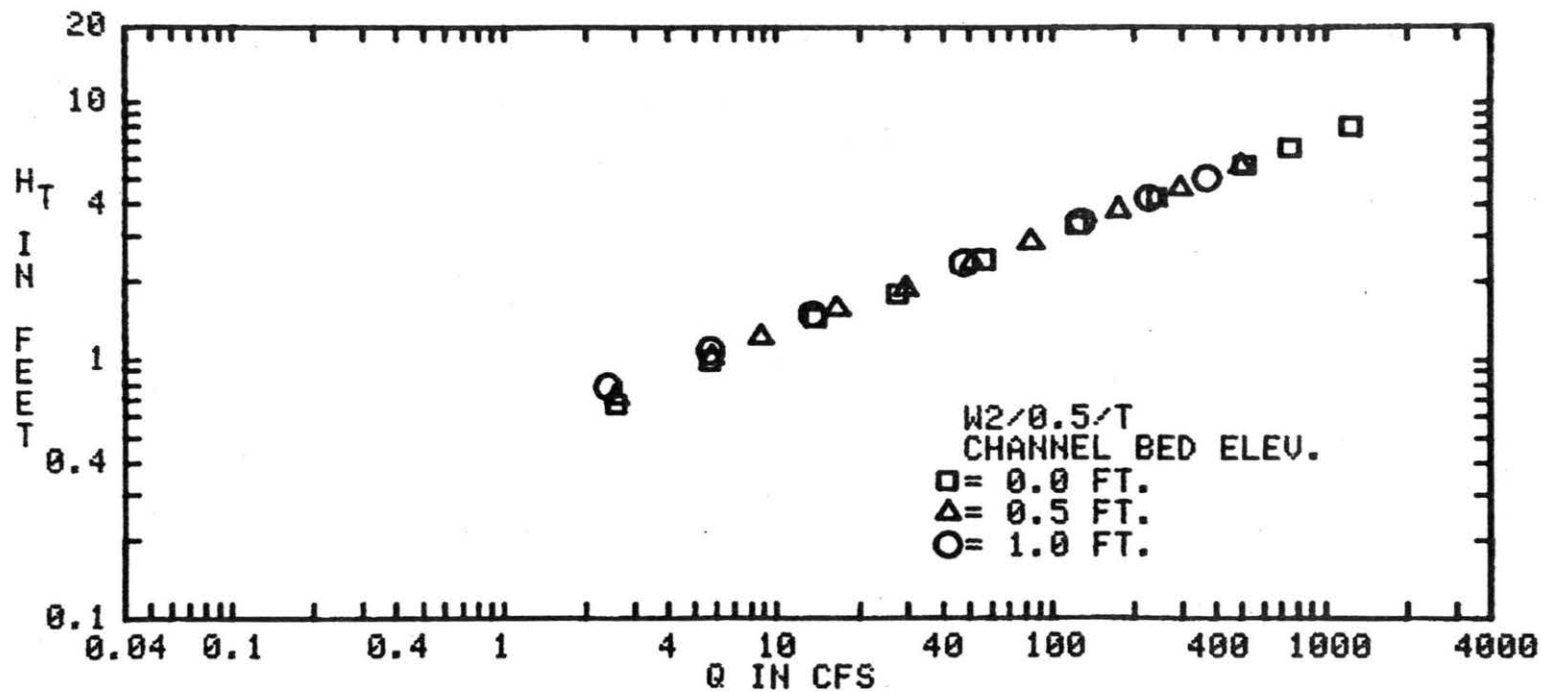

FIG. 13a PLOT OF TOTAL HEAD versus DISCHARGE DATA POINTS

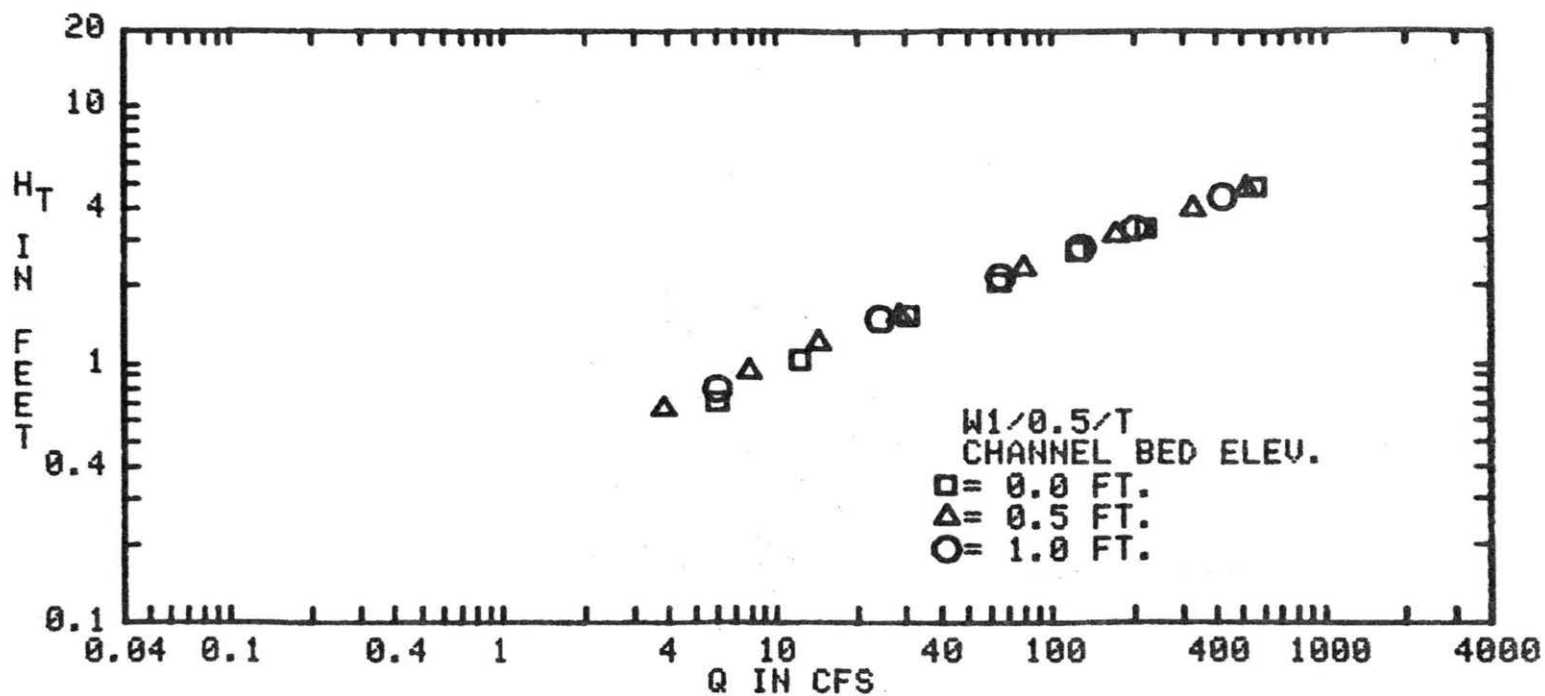

FIG. 13b PLOT OF TOTAL HEAD versus DISCHARGE DATA POINTS

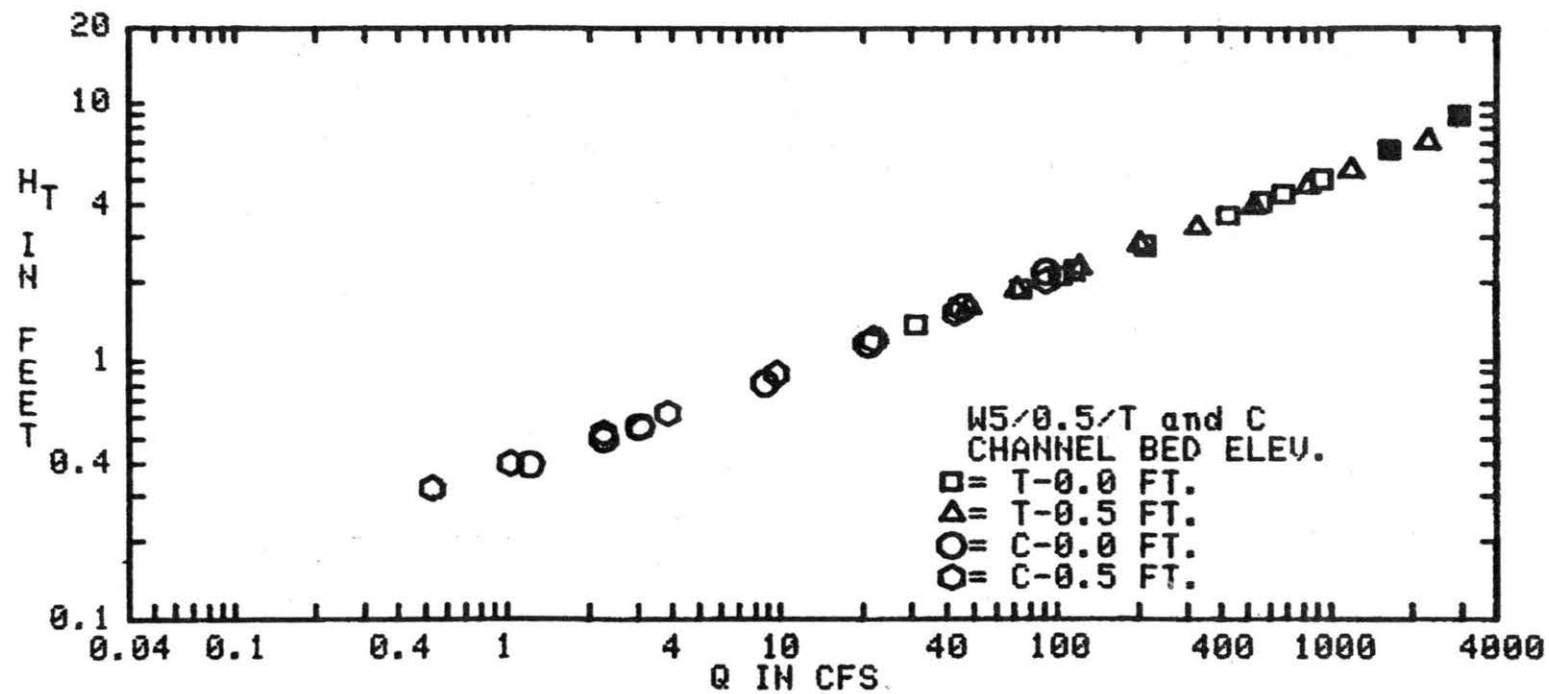

FIG. 13c PLOT OF TOTAL HEAD versus DISCHARGE DATA POINTS

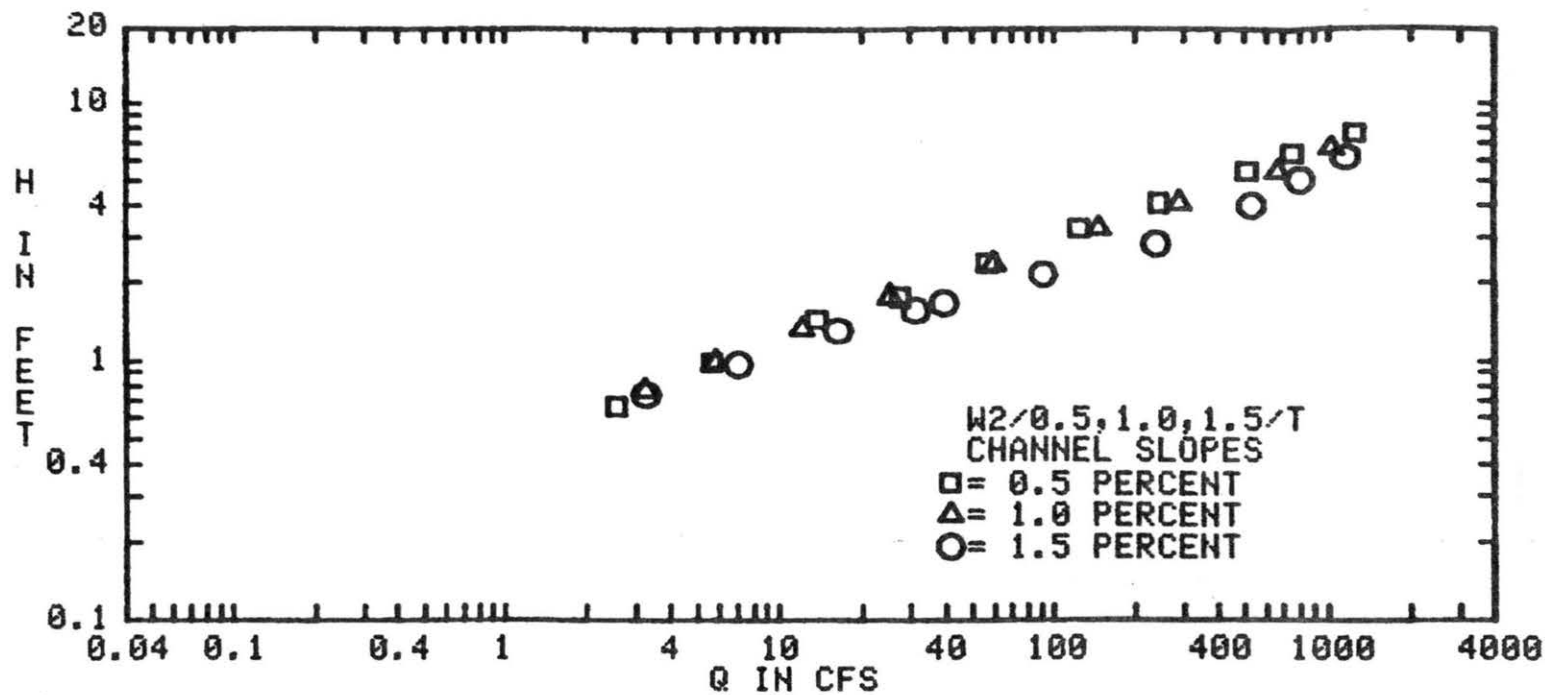

FIG. 14a PLOT OF HEAD versus DISCHARGE DATA POINTS

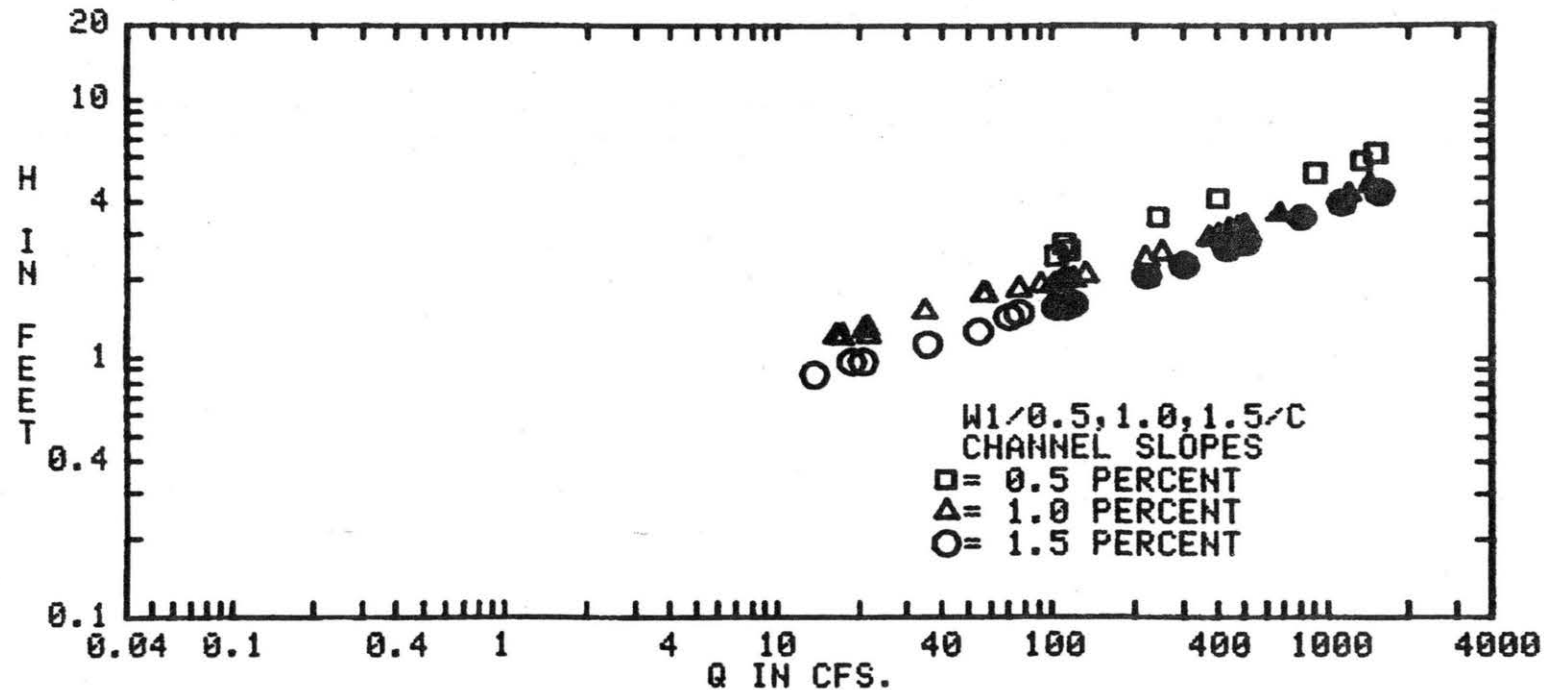

FIG. 14b PLOT OF HEAD versus DISCHARGE DATA POINTS

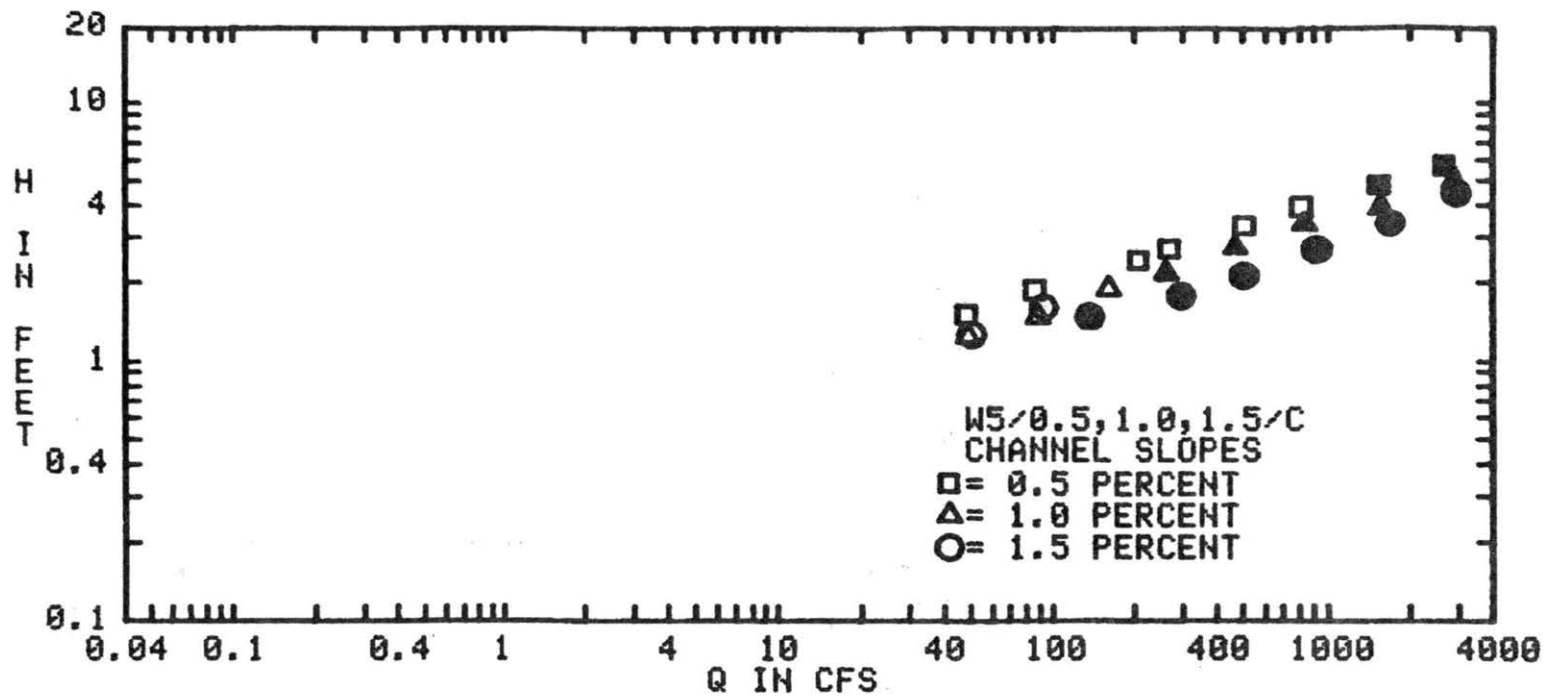

FIG. 14c PLOT OF HEAD versus DISCHARGE DATA POINTS

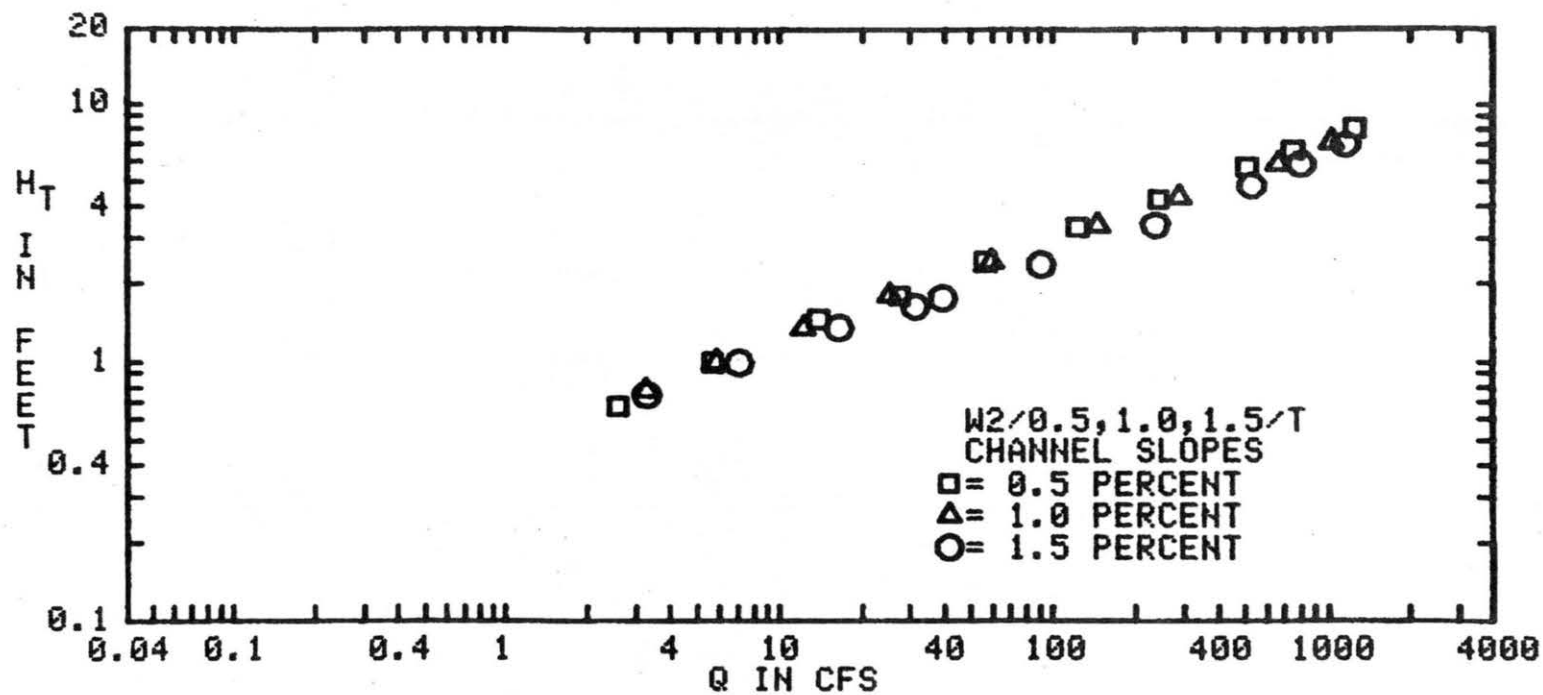

FIG. 15a PLOT OF TOTAL HEAD versus DISCHARGE DATA POINTS

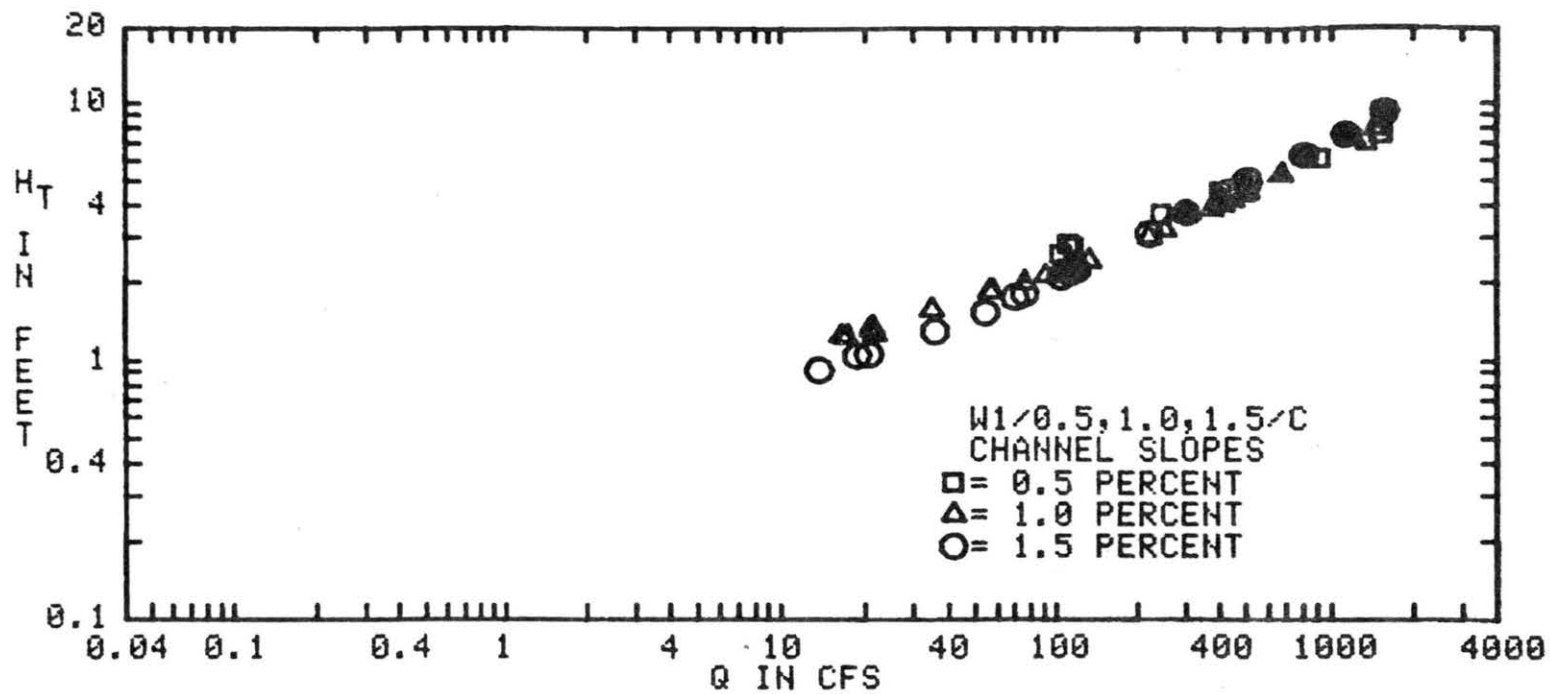

FIG. 15b PLOT OF TOTAL HEAD versus DISCHARGE DATA POINTS

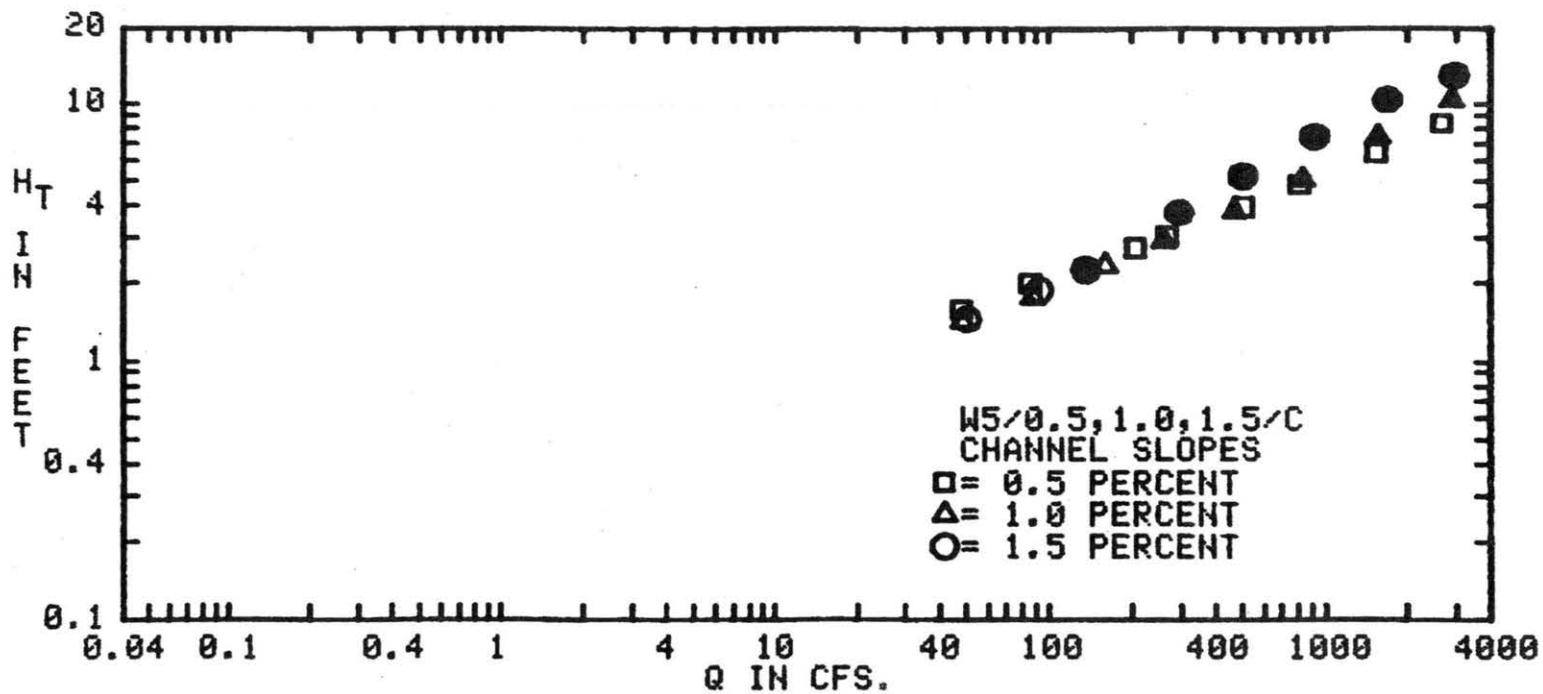

FIG. 15c PLOT OF TOTAL HEAD versus DISCHARGE DATA POINTS

Chapter VI

ANALYSIS

The objectives of the study centered on developing the relationships between approach channel conditions and weir discharge ratings. Toward this end results of studies by Ruff, Dang, and Saxton (1977), Dang (1976), and Gwinn et al. (1967) were added to the results for analysis.

The weir calibration curves (Figure A-1 to A-61) for each weir type were analyzed to develop sets of generalized head versus discharge curves. Channel conditions which showed nearly similar weir rating effects were combined into single data sets. Rating curves were formulated using a least squares analysis of the combined data. Approach channel conditions which caused major weir rating effects were represented by separate curves. These curves for the 2:1, 3:1, and 5:1 weirs are shown in Figures 16 through 18, respectively. For each weir type the generalized curves extend only over the regions for which the curves are considered to be applicable based upon the approach channel slopes and the elevation of the channel bed below the V-notch of the weir. The combined approach channel test conditions underlying each of the generalized curves are summarized in Table 3. The effects of channel area were not sufficiently defined by the testing to allow it to be used as a general delineator.

The range of channel cross sections tested in this study for the 2:1 and 3:1 weirs revealed negligible rating effects related to channel area. The channel cross sections tested with the 2:1 weir ranged in specific areas (channel cross-sectional area based on a 1 ft depth) from 4.6 ft² to 9.0 ft². Channels tested in conjunction with the 3:1 weir had specific areas between 4.6 ft² and 10.0 ft². Some calibration effects were noted between

TABLE 3

Classification of Weir Rating Effects

Rating Curve (Graph No.)	Channel Conditions Bed Slope	Bed Elevations	Model Test Run Number
<u>2:1 Weir</u>			
16-1	0.0%	-0.5', -0.0'	18, 19, 22, 23, 24
	0.5%	-0.5', -0.0'	25, 26, 27, 36, 37
	1.0%	-0.5'	40, 41
16-2	1.0%	-0.0', -0.2'	20, 28, 38
16-3	1.5%	-0.0', -0.2'	21, 29, 39

<u>3:1 Weir</u>			
17-1	0.0%	-0.5', -0.0'	1, 2, 3, 7, 8, 9
	0.5%	-0.5', -0.0'	10, 11, 14, 15, 16
	1.0%	-0.5'	17, 30, 31, 34, 35
	1.5%	-0.5'	
17-2	1.0%	-0.0'	5, 12, 32
17-3	1.5%	-0.0'	6, 13, 33

<u>5:1 Weir</u>			
18a-1	0.0%	-0.0', -0.5'	42, 43, 46, 47, 48
	0.5%	-0.0', -0.5'	50, 51
	1.0%	-0.5'	
18a-2	1.0%	-0.0'	44, 45, 49, 52, 53
	1.5%	-0.0', -0.5'	
18b-1	0.0%	-0.0', -0.5'	54, 58, 59, 60
	0.5%	-0.5'	
	1.0%	-0.5'	
18b-2	0.5%	-0.0'	55
18b-3	1.0%	-0.0'	56, 57, 61
	1.5%	-0.0', -0.5'	

channel cross sections tested in conjunction with the 5:1 weir. Channel forms used in the 5:1 weir had specific areas from 7.3 ft² to 19.6 ft².

By utilizing Dang's (1976) calibration data involving wide rectangular approach channels (specific area = 40.0 ft², see Figure 4 and 5), rating effects dependent on channel area were also apparent for the 2:1 and 3:1 weirs. The following discussion of the generalized weir ratings outline the cited examples of channel area effects.

The generalized composite curves are presented as guidelines for establishing weir ratings for similar channel conditions and for determining probable rating effects due to changes in approach channel conditions. Approach channel roughness from the model studies corresponds to prototype channels with Manning's roughness values in the range of 0.015 to 0.025.

2:1 Weir

Figure 16 shows the composite 2:1 broad-crested V-notch weir calibration ratings. Three generalized rating curves were developed. The curves show a general increase in the slope of the ratings curves for both increased channel slope and decreased bed elevation. Weir rating effects were less apparent for changes in bed elevation at small approach channel slopes.

Curve 16-1 was developed from the tests outlined in Table 3. Weir ratings for channels sloping at 0.0 and 0.5 percent were tested at bed elevations between 0.0 ft and -1.0 ft. The same curve also involved calibration data obtained from 1.0 and 1.5 percent sloping channels which were tested with bed elevations of -0.5 ft and -1.0 ft. Curves 16-2 and

16-3 were developed from channels tested at bed elevations from 0.0 ft to -0.2 ft with channel slopes of 1.0 and 1.5 percent, respectively.

The dashed line indicates a weir rating developed by Dang (1976), from weir calibration tests conducted using wide rectangular approach channels with bed elevations of 7.5 ft at mild bed slopes (see Figure 4). The approach channel conditions defined by Dang's tests illustrate nearly ideal conditions. Figure 16 illustrates the general magnitude of rating variations which can occur due to large changes in approach channel size and bed elevation. The weir ratings associated with the rectangular approach channel show lower discharges for a given head than the other curves in Figure 16 would indicate.

3:1 Weir

The composite 3:1 broad-crested V-notch weir ratings are shown in Figure 17. The three curves tend to converge at low discharges and show an increase in discharge at a given head with increasing channel bed slope and with decreasing bed elevation. Curve 17-1 was developed from weir ratings for channel slopes of 0.0 and 0.5 percent with bed elevations of 0.0 ft, -0.5 ft and -1.0 ft (see Table 3). The curve also corresponds to weir ratings defined by 1.0 and 1.5 percent channel bed slopes tested with bed elevations of -0.5 ft and -1.0 ft. Calibration curve 17-2 represents data for a 1.0 percent approach slope and bed elevations of 0.0 ft to -0.2 ft. The third rating curve 17-3 resulted from similar tests with the channel slope increased to 1.5 percent.

The dashed rating curve shown in Figure 17 is from Dang's (1976) work using mild slope, wide rectangular approach channels (specific area = 40.00 ft², see Figure 4a) Comparison of the curves reflects the

effect of large differences in approach channel area and bed elevation on the weir ratings.

5:1 Weir

Two sets of generalized curves were developed for the 5:1 weir tests to show channel area effect, Figures 18a and 18b. The curves in Figure 18a reflect the test results obtained using the wide circular and trapezoidal approach channels (specific area - 19.6 ft² and 13.1 ft², refer to Figure 9g and 9i). Weir ratings for the narrow circular approach channel (specific area = 7.3 ft², refer to Figure 9h) are shown in Figure 18b.

A comparison of the channel conditions given in Table 3 representing the 5:1 weir rating curves in Figures 18a and 18b show significant rating effects occur at milder approach channel bed slopes with narrower approach channel. The weir ratings for the wide and narrow approach channels nearly converge under conditions of a horizontal bed slope where velocity head effects are minimized.

Curve 18a-1 (Figure 18a) characterizes 0.0 and 0.5 percent channel slopes tested at bed elevations of 0.0 ft and -0.5 ft and 1.0 percent channel slope with a -0.5 ft bed elevation. Curve 18b-1 (Figure 18b) was formulated from model tests of nearly similar channel conditions. The curve reflects the channel conditions of Curve 18a-1 except for the 0.5 percent, -0.0 ft approach channel. The channel size effect is evident for the 0.5 percent channel slope with a 0.0 ft bed elevation. Higher discharges for these conditions are shown by Curve 18b-2. The second curve (18a-2) in Figure 18a and the third curve in Figure 18b compare more closely with the 2:1 and 3:1 weir tests at steeper channel bed

slope conditions. Both curves encompass the test results of 1.0 percent channel slopes with a 0.0 ft bed elevation and 1.5 percent channel slopes using both 0.0 ft and -0.5 ft bed elevations.

Coefficient of Discharge

The discharge coefficient, C_d , was determined for each test run and is tabulated in Appendix A. The values of C_d were calculated assuming an exponent for H_T of 2.5 and a value for α of 1.116. Graphs of C_d versus H_T for each series of tests are presented in Appendix C. However, the graphs show only the points for subcritical approaching flow.

The C_d values obtained for tests performed with the 2:1, 3:1 and 5:1 weir and a circular approach channel are compared with C_d values computed from the data reported by Dang (1976) and Gwinn et al. (1967). Three C_d values for each weir were calculated from Gwinn's data at head to crest thickness ratios of 0.1, 0.3 and 0.7. These comparisons are shown in the graphs of Figures 19, 20 and 21 for the three weirs. The tests performed during this study attempted to bridge the gap between Gwinn's results at ranges of total head generally less than 1 ft and Dang's results at the intermediate and high ranges of total head generally greater than 1 to 2 ft. The results of the three studies show general agreement. The shape of the C_d curves shown in Figures 19, 20 and 21 are typical of results obtained for tests involving mild sloping or horizontal approach channels. The plots show that the value of C_d changes more rapidly at total heads less than 1 ft, than for larger total heads. In some of the plots shown in Appendix C, for approach channel slopes greater than 0.5 percent and at the smaller distances between the V-notch and the channel bed, the magnitude of C_d reaches

a maximum and then decreases. Generally, when C_d reached the maximum and the total head was 2 to 4 ft, the flow was near critical and the Froude number was approaching a value of one. This indicated that the channel was beginning to act as the control rather than the weir and the flow was in a transition zone. When C_d values increased significantly at values of total head on the order of 0.5 ft or less, no apparent reason for the increase could be determined. Surface tension effects may have been a factor at these lower heads.

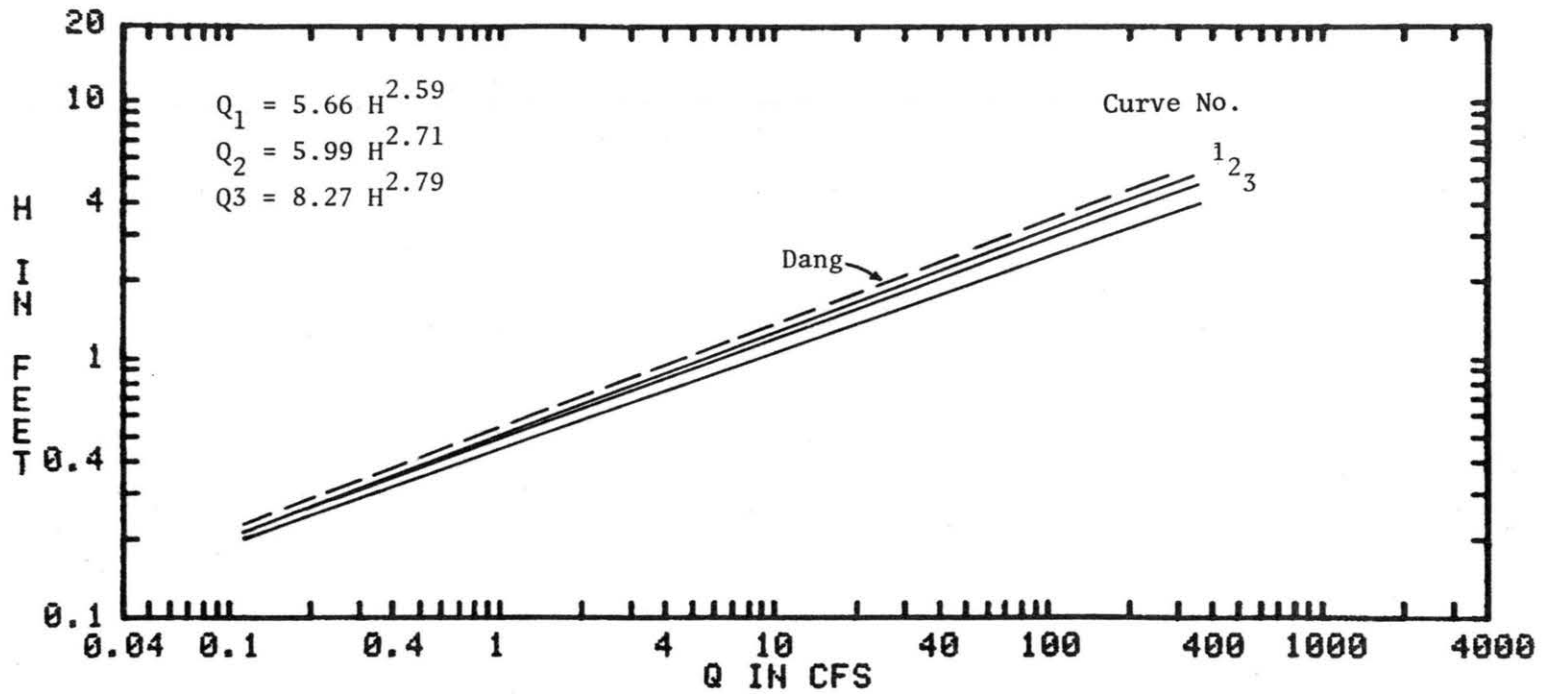

FIG. 16 - GENERALIZED RATING CURVES, 2:1 WEIR

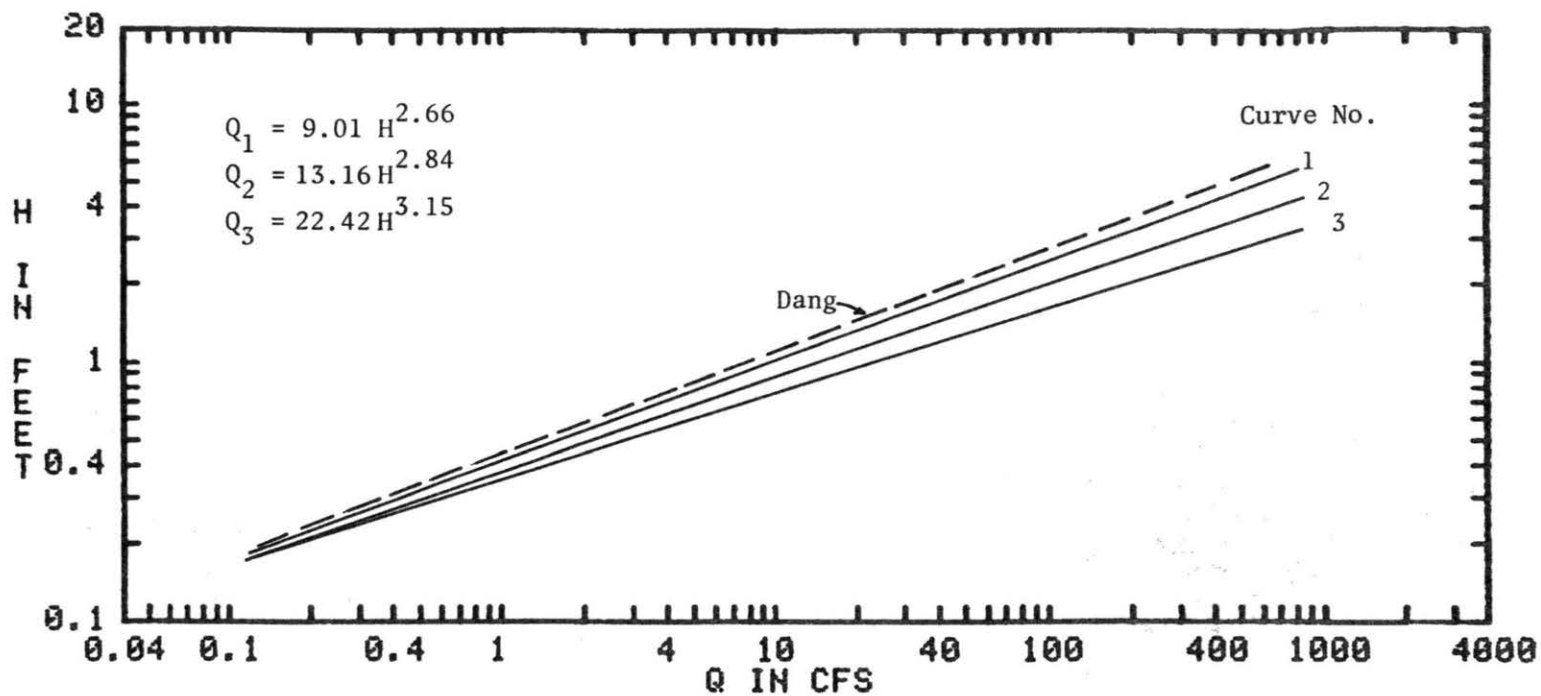

FIG. 17 - GENERALIZED RATING CURVES, 3:1 WEIR

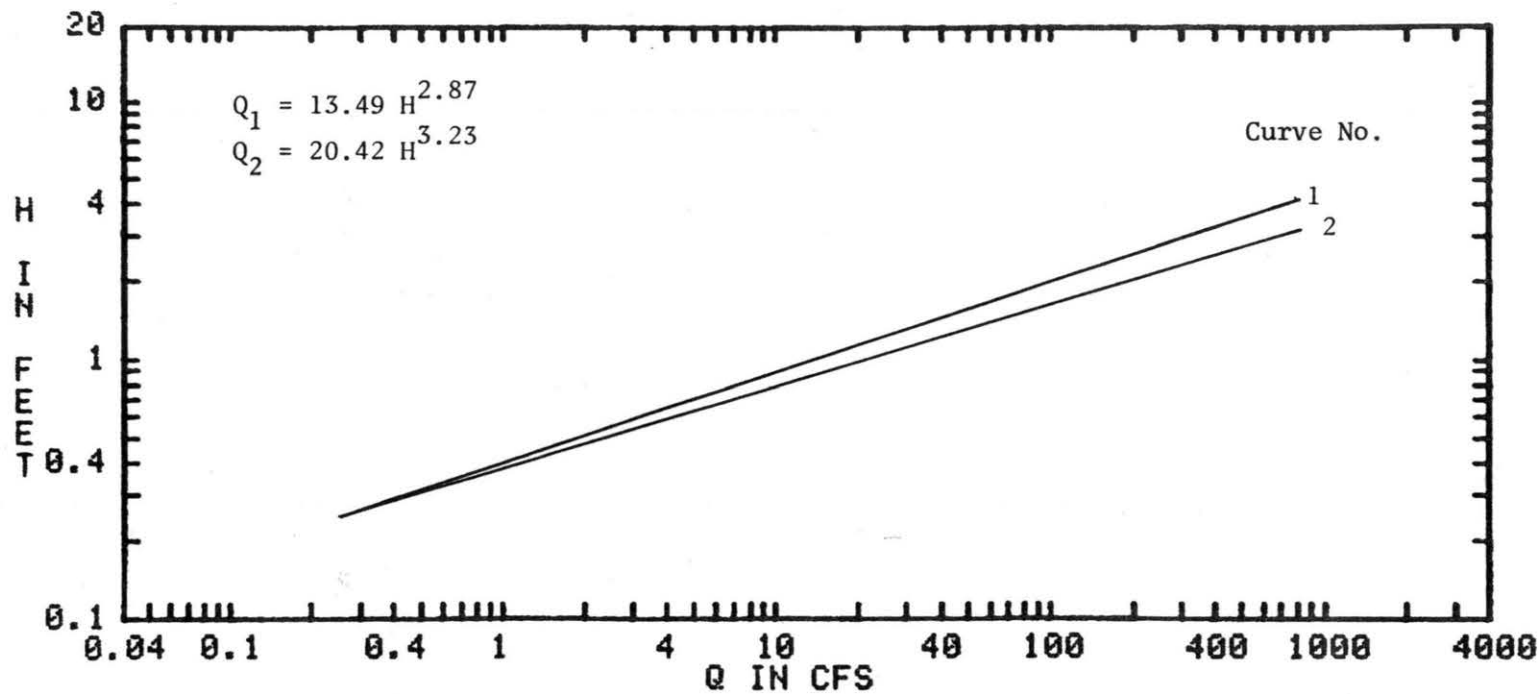

FIG. 18a - GENERALIZED RATING CURVES, 5:1 WEIR

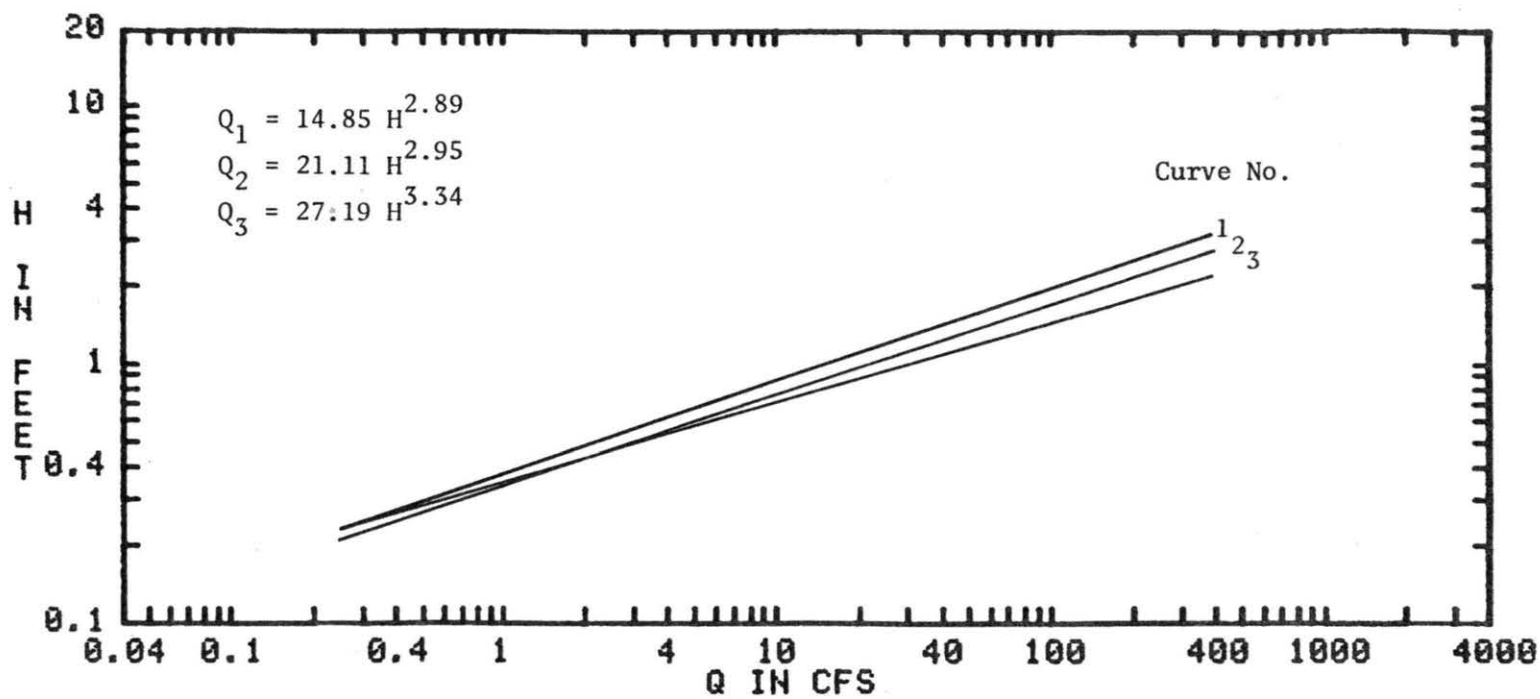

FIG. 18b - GENERALIZED RATING CURVES, 5:1 WEIR

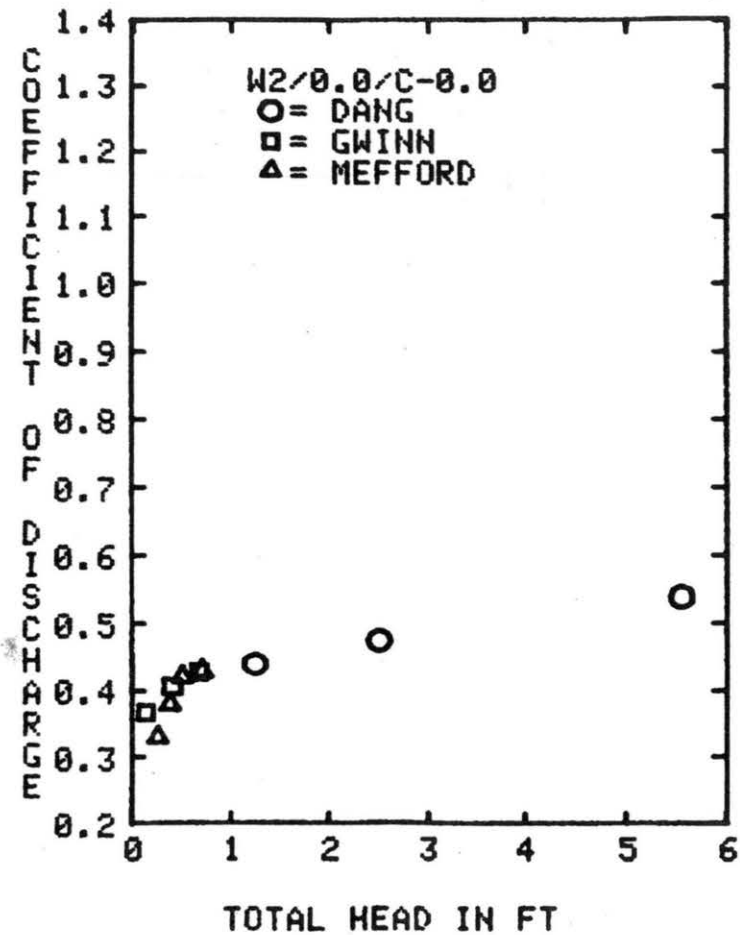

FIG. 19 - COEFFICIENT OF DISCHARGE COMPARISONS - 2:1 WEIR

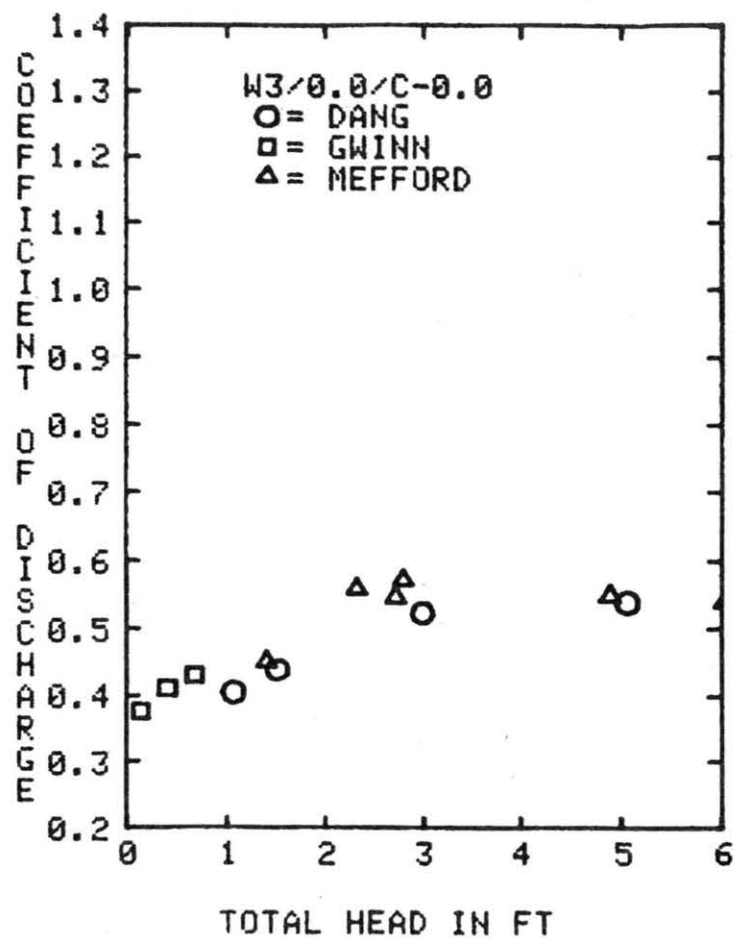

FIG. 20 - COEFFICIENT OF DISCHARGE COMPARISONS - 3:1 WEIR

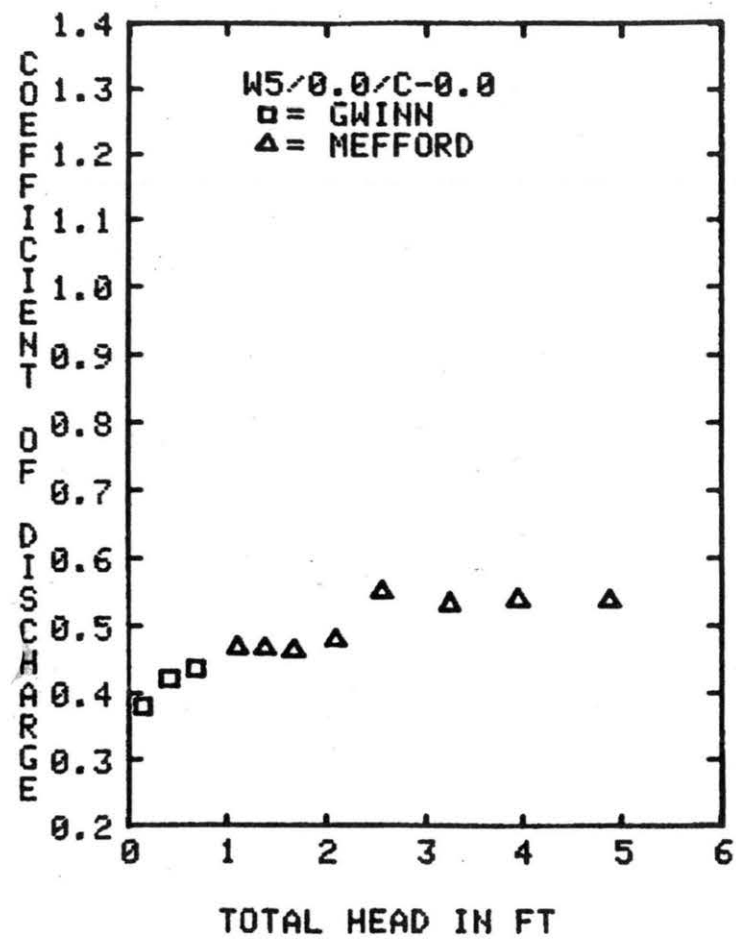

FIG. 21 - COEFFICIENT OF DISCHARGE COMPARISONS - 5:1 WEIR

Chapter VII

SUMMARY, CONCLUSIONS & RECOMMENDATIONS

Broad-crested V-notch weirs have been used extensively in the United States to determine the discharge from small watersheds. The original laboratory calibrations conducted in 1938 - 1940 of these weirs was limited to narrow trapezoidal approach channels. More recent calibrations of specific weir sites made in 1975 showed that different approach channel cross sections and slopes cause significant deviations for the original calibrations. Therefore, the objective of this study was to extend the calibrations of V-notch weirs with side slopes of 2, 3, and 5 horizontal to 1 vertical and to demonstrate the influence of channel cross sectional areas, channel bed elevation, and channel slope on the weir ratings.

Model studies were conducted using fixed-boundary channels. The weirs were tested at model-prototype scales of 1:10, 1:5, 1:2.5 and 1:1. Rectangular, trapezoidal, and circular channel cross sections were tested mainly at four channel slopes of 0.0, 0.5, 1.0 and 1.5 percent. The approach channel area was varied by changing the location of the notch with respect to the channel bed in addition to using the different geometric cross sections.

There was no obvious effect on the weir rating due to geometric changes in the approach channel area for the 2:1 and 3:1 triangular weirs tested in this study when compared to each other. This is apparent in Figures 10a and 10b which shows the rating curves for combination of the different channels tested at 0.5 percent slope. It is apparent that the tests were not made over a broad enough range of areas. There is an area effect when the channels are compared to a large channel with low approach velocities as evident in Figures 16 and 17.

The rating curves for the 5:1 triangular weir shown in Figure 10c indicate the effect due to changes in approach channel area. The smaller circular channel with a 12.1 ft radius indicates a greater discharge at a given head than the larger circular and trapezoidal channels. These differences in discharge are not evident in Figure 11c when the velocity head is taken into account which reflects the influence of the velocity head component on the total head. Similar comparisons can be made between Figures 14c and 15c for the 5:1 triangular weir when the bed elevation is lowered and the approach channel area is thus increased. The most significant effects due to channel area are evident when the channel area decreases and approaches the cross sectional flow area of the weir. In the limit, if these areas are equal, the channel and weir form a chute and the flow is controlled by the slope and channel roughness rather than by the weir.

The approach channel slope also affects the weir calibrations mainly through the approach velocity. This is evident by comparing the plots of head versus discharge shown in Figure 14 with the corresponding plots of total head versus discharge in Figure 15. The addition of the velocity head in Figure 15 tends to make the ratings become more congruent. When the velocity head is not included as in Figure 14, the discharge can differ on the order of 100 percent at heads of 3 to 4 ft. At slopes less than 0.5 percent, the changes in the rating curves can not be readily distinguished.

Numerous runs were tested under supercritical flow conditions. When flow becomes supercritical in the channel, the control also reverts to that due to the channel slope and roughness. These appears to be a smooth transition between the two types of controls for the model channels. This may not be the case for the dynamic and mobile channel beds found in the field. Therefore, the ratings recommended for use are those where the flow is subcritical.

Individual test data is presented both in tabular and graphical form in Appendices A and B for all the channel-weir combinations studied. Generalized weir rating curves representative of several weir channel conditions are presented in Figures 16, 17, and 18 for the 2:1, 3:1, and 5:1 triangular weirs, respectively. Table 3 presents the conditions for which these general curves are applicable.

The improved rating determined by this study of the broad-crested V-notch weir will provide a better determination of flow rates for field installations where incorrect ratings or no ratings existed before. Field measurements of approach channel slope and cross section will indicate which rating curve is most appropriate for a given installation. The hydrologist will have improved and accurate flow measurements which can be used to base economic, social, and scientific interpretations.

REFERENCES

1. Agricultural Research Service, (1962), Field Manual for Research in Agricultural Hydrology, Agricultural Handbook No. 224, U. S. Government Printing Office, pp. 34-40.
2. Chow, V., 1959, "Open Channel Hydraulics, McGraw Hill, pp. 21, 51-53.
3. Dang, C. 1976, "Rating of the Broad Crested V-notch Weir". Master's Thesis, Colorado State University,
4. DeCoursey, D. G., Blanchard, B. J., 1970, "Flow Analysis of Large Triangular Weir". Proceedings of the American Society of Civil Engineers, HY7, 1435-1454.
5. Govinda Rao, N. S., and Muralidhar, D., (1963), "Discharge Characteristics of Weirs of Finite Crest Width". Houille Blanche 18(5), 537-545.
6. Gwinn, W. R., Ree, W. O. and DeCoursey, D. G., (1967), "The Low-Flow Performance of Broad-Crested V-notch Weirs", USDA-ARS, Stillwater, Oklahoma, Unpublished Annual Report, pp, 51-84.
7. Hall, G. W., (1962), "Analytical Determination of the Discharge Characteristics of Broad-Crested Weirs using Boundary Layer Theory", Proceedings of the Institution of Civil Engineers, Paper 6607, June, 177-190.
8. Huff, A. M., (1938), "Tests of 160 inch Weir and Comparison with 30-inch Weir", Report No. 1, Cornell University, Section of Watershed and Hydrology Studies.
9. Huff, A. N., (1941a), "Calibration of 2:1 V-notch Measuring Weirs, St. Anthony Falls Hydraulic Laboratory, Minneapolis, Minnesota, Report No. MN-R-3-8.
10. Huff, A. N., (1941b), "Calibration of 3:1 V-notch Measuring Weirs, St. Anthony Falls Hydraulic Laboratory, Minneapolis, Minnesota, Report No. MN-R-3-8-.
11. Huff, A. N., (1942), "Calibration of 3:1 and 5:1 V-notch Measuring Weirs, Supplement to Calibration of 2:1 V-notch Measuring Weirs", St. Anthony Falls Hydraulic Laboratory, Minneapolis, Minnesota, Report No. MN-R-3-7.
12. Lakshinana, Rao, Negar, S., 1975, "Theory of Weirs", Vol. 10 of Advances in Hydrosience, Edited by Ven Te Chow, New York: Academic Press.
13. Rouse, H., (1971), "Selected Writings of Hunter Rouse, Characteristics of Flow over Terminal Weirs and Sills", Dover Press, pp. 286-298.

14. Ruff, J. F., Saxton, K. E., and Dang, C., (1977), "A Detailed Report of Rating Broad Crested V-notch Weirs with Narrow, Sloping Approach Channels and Sediment Deposits", Report prepared for USDA, Agricultural Research Service. Colorado State University, Engineering Research Center, CER76-77JFR-CD53.
15. Singamsetti Sarga Rao, Manoy Kumar Skukla, (1971), "Characteristics of Flow over Weirs of Finite Crest Width", Proceedings of the American Society of Civil Engineers, HY11, 1807-1816.
16. Skogerboe, G. V., Walker, W. R., (1971), "Flow Analysis of Large Triangular Weir", Proceedings of the American Society of Civil Engineers, HY4, 609-613.
17. Smith, C. D., Liang, W. S., (1969), "Triangular Broad-Crested Weir", Proceedings of the American Society of Civil Engineers, IR4, 493-501.
18. Tracey, H. J., (1957), "Discharge Characteristics of Broad-Crested Weirs", Geological Survey Circular No. 397, U. S. Department of the Interior.

Appendix A

TABULATION OF TEST DATA
HEAD VS DISCHARGE DATA PLOTS

TABLE A- 1

W1/0.00/C-0.18/5:1

No.	Q _M (cfs)	Q _P (cfs)	H _M (ft)	H _P (ft)	A _P (ft ²)	V _P (ft/sec)	H _V (ft)	H _T (ft)	Y _N (ft)	Y _C (ft)	F	C _d
1	29.53	1650.90	1.373	6.87	203.41	8.12	1.142	8.01	INF.	6.42	.75	.535
2	30.02	1678.26	1.374	6.87	203.66	8.24	1.178	8.05	INF.	6.48	.76	.537
3	27.36	1529.75	1.344	6.72	196.19	7.80	1.054	7.77	INF.	6.18	.73	.533
4	27.10	1514.94	1.338	6.69	194.71	7.78	1.050	7.74	INF.	6.15	.73	.534
5	23.35	1305.30	1.274	6.37	179.27	7.28	.919	7.29	INF.	5.70	.70	.535
6	14.66	819.52	1.083	5.42	136.85	5.99	.622	6.04	INF.	4.51	.61	.538
7	8.83	493.61	.895	4.48	100.43	4.91	.419	4.89	INF.	3.49	.55	.547
8	2.25	125.95	.530	2.65	44.88	2.81	.137	2.79	INF.	1.76	.39	.571
9	2.02	112.89	.519	2.60	43.51	2.59	.117	2.71	INF.	1.66	.36	.548
10	1.38	77.27	.445	2.23	34.81	2.22	.085	2.31	INF.	1.38	.33	.560
11	.32	17.64	.276	1.38	18.01	.98	.017	1.40	INF.	.66	.18	.450

TABLE A- 2

W1/0.25/C-0.18/5:1

No.	Q _M (cfs)	Q _P (cfs)	H _M (ft)	H _P (ft)	A _P (ft ²)	V _P (ft/sec)	H _V (ft)	H _T (ft)	Y _N (ft)	Y _C (ft)	F	C _d
1	16.25	908.60	1.102	5.51	139.77	6.50	.733	6.24	4.29	4.75	.66	.548
2	13.47	753.09	1.036	5.18	126.24	5.97	.617	5.80	3.93	4.32	.63	.547
3	8.77	490.47	.886	4.43	97.93	5.01	.435	4.86	3.21	3.48	.56	.552
4	8.42	470.48	.875	4.38	95.99	4.90	.417	4.79	3.15	3.41	.55	.550
5	7.79	435.44	.850	4.25	91.64	4.75	.392	4.64	3.03	3.28	.54	.551
6	8.47	473.38	.883	4.42	97.40	4.86	.410	4.82	3.15	3.42	.55	.544
7	6.03	337.04	.775	3.88	79.16	4.26	.314	4.19	2.69	2.88	.51	.551
8	2.15	120.06	.536	2.68	45.00	2.67	.123	2.80	1.66	1.72	.37	.536
9	2.08	116.53	.531	2.66	44.38	2.63	.120	2.77	1.64	1.69	.37	.534
10	2.00	111.89	.523	2.62	43.39	2.58	.115	2.73	1.61	1.66	.36	.534
11	1.90	106.27	.513	2.57	42.17	2.52	.110	2.68	1.57	1.61	.36	.534
12	1.65	92.48	.485	2.43	38.82	2.38	.098	2.52	1.47	1.51	.35	.537
13	1.39	77.63	.449	2.25	34.70	2.24	.087	2.33	1.36	1.38	.34	.549
14	.79	44.24	.362	1.81	25.53	1.73	.052	1.86	1.04	1.04	.28	.549
15	.37	20.87	.270	1.35	17.06	1.22	.026	1.38	.74	.71	.23	.552
16	.37	20.41	.268	1.34	16.89	1.21	.025	1.37	.73	.71	.23	.551
17	.23	12.72	.225	1.13	13.39	.95	.016	1.14	.59	.56	.19	.538

TABLE A- 3

W1/0.50/C-0.18/5:1

No.	Q _M (cfs)	Q _P (cfs)	H _M (ft)	H _P (ft)	A _P (ft ²)	V _P (ft/sec)	H _V (ft)	H _T (ft)	Y _N (ft)	Y _C (ft)	F	C _d
1	27.17	1518.85	1.240	6.20	169.01	8.99	1.401	7.60	4.65	6.17	.88	.560
2	24.01	1342.20	1.160	5.80	151.10	8.88	1.368	7.17	4.38	5.79	.89	.573
3	16.23	907.28	1.040	5.20	126.04	7.20	.899	6.10	3.64	4.75	.76	.580
4	7.16	400.47	.833	4.17	87.89	4.56	.360	4.53	2.48	3.15	.53	.540
5	4.36	243.53	.700	3.50	66.77	3.65	.231	3.73	1.96	2.45	.45	.532
6	1.98	110.89	.545	2.73	45.50	2.44	.103	2.83	1.36	1.65	.34	.485
7	2.07	115.60	.520	2.60	42.41	2.73	.129	2.73	1.39	1.69	.39	.552
8	1.85	103.60	.494	2.47	39.29	2.64	.121	2.59	1.32	1.60	.38	.564

TABLE A- 4

W1/0.75/C-0.18/5:1

No.	Q _M (cfs)	Q _P (cfs)	H _M (ft)	H _P (ft)	A _P (ft ²)	V _P (ft/sec)	H _V (ft)	H _T (ft)	Y _N (ft)	Y _C (ft)	F	C _d
1	25.00	1397.53	1.046	5.23	126.24	11.07	2.125	7.36	4.06	5.92	1.16	.560
2	24.84	1388.64	.888	4.44	96.52	14.39	3.590	8.03	4.04	5.90	1.63	.447
3	12.93	722.78	.821	4.11	85.04	8.50	1.253	5.36	2.97	4.24	.99	.639
4	8.91	498.07	.745	3.73	72.84	6.84	.811	4.54	2.50	3.51	.83	.668
5	8.04	449.60	.715	3.58	68.27	6.59	.752	4.33	2.38	3.34	.82	.678
6	7.89	441.16	.705	3.53	66.77	6.61	.757	4.28	2.36	3.31	.82	.683
7	5.25	293.31	.632	3.16	56.31	5.21	.471	3.63	1.95	2.69	.68	.686
8	5.17	289.01	.644	3.22	57.97	4.99	.431	3.65	1.94	2.67	.65	.667
9	2.25	125.98	.492	2.46	38.47	3.27	.186	2.65	1.31	1.76	.48	.650
10	2.05	114.36	.477	2.39	36.74	3.11	.168	2.55	1.26	1.68	.46	.645
11	1.84	102.79	.462	2.31	35.03	2.93	.149	2.46	1.20	1.59	.44	.637
12	1.43	80.13	.435	2.18	32.05	2.50	.108	2.28	1.07	1.40	.38	.598
13	1.27	70.81	.414	2.07	29.81	2.38	.098	2.17	1.01	1.32	.37	.601
14	.96	53.54	.373	1.87	25.62	2.09	.076	1.94	.88	1.15	.34	.600
15	.56	31.40	.301	1.51	18.88	1.66	.048	1.55	.69	.88	.30	.614
16	.38	21.22	.270	1.35	16.22	1.31	.030	1.38	.58	.72	.25	.558
17	.35	19.70	.263	1.32	15.64	1.26	.028	1.34	.56	.69	.24	.554
18	.31	17.06	.245	1.23	14.18	1.20	.025	1.25	.52	.65	.24	.574

TABLE A- 5

W1/1.00/C-0.18/5:1

No.	Q _M (cfs)	Q _P (cfs)	H _M (ft)	H _P (ft)	A _P (ft ²)	V _P (ft/sec)	H _V (ft)	H _T (ft)	Y _N (ft)	Y _C (ft)	F	C _d
1	25.76	1440.22	.937	4.69	104.42	13.79	3.299	7.98	3.84	6.01	1.53	.470
2	21.56	1205.41	.864	4.32	91.47	13.18	3.012	7.33	3.53	5.49	1.51	.487
3	12.00	670.82	.715	3.58	67.52	9.94	1.712	5.29	2.68	4.09	1.24	.613
4	9.03	504.74	.643	3.22	57.14	8.83	1.353	4.57	2.35	3.54	1.15	.665
5	8.92	498.91	.639	3.20	56.58	8.82	1.348	4.54	2.34	3.52	1.15	.666
6	8.88	496.39	.646	3.23	57.55	8.63	1.290	4.52	2.33	3.51	1.12	.672
7	8.79	491.32	.638	3.19	56.44	8.70	1.314	4.50	2.32	3.49	1.14	.671
8	8.62	481.88	.630	3.15	55.34	8.71	1.315	4.46	2.30	3.46	1.15	.672
9	7.93	443.05	.625	3.13	54.66	8.11	1.139	4.26	2.21	3.32	1.07	.693
10	7.27	406.68	.589	2.95	49.86	8.16	1.154	4.10	2.12	3.18	1.11	.703
11	6.68	373.49	.574	2.87	47.92	7.79	1.054	3.92	2.04	3.04	1.07	.720
12	4.51	251.95	.509	2.55	39.89	6.32	.692	3.24	1.70	2.50	.91	.785
13	3.94	220.10	.484	2.42	36.97	5.95	.615	3.03	1.59	2.33	.88	.806
14	2.37	132.44	.418	2.09	29.71	4.46	.345	2.43	1.26	1.81	.70	.841
15	2.13	119.16	.403	2.02	28.15	4.23	.311	2.33	1.20	1.71	.68	.849
16	2.00	111.93	.404	2.02	28.25	3.96	.272	2.29	1.16	1.66	.63	.827
17	1.94	108.35	.392	1.96	27.03	4.01	.279	2.24	1.15	1.63	.65	.849
18	1.82	101.97	.385	1.93	26.32	3.87	.260	2.19	1.11	1.58	.63	.849
19	1.63	91.39	.383	1.92	26.12	3.50	.212	2.13	1.06	1.50	.57	.814
20	1.37	76.47	.367	1.84	24.54	3.12	.168	2.00	.98	1.37	.52	.791
21	1.03	57.80	.353	1.77	23.20	2.49	.108	1.87	.86	1.19	.42	.708
22	1.01	56.63	.353	1.77	23.20	2.44	.103	1.87	.85	1.18	.41	.697
23	.62	34.86	.305	1.53	18.80	1.85	.060	1.58	.68	.93	.34	.648
24	.38	21.35	.259	1.30	14.90	1.43	.036	1.33	.54	.72	.28	.614
25	.37	20.95	.258	1.29	14.82	1.41	.035	1.32	.54	.72	.28	.610
26	.39	21.63	.244	1.22	13.70	1.58	.043	1.26	.54	.73	.32	.709
27	.31	17.32	.242	1.21	13.54	1.28	.028	1.24	.49	.65	.26	.596
28	.30	16.50	.244	1.22	13.70	1.20	.025	1.25	.48	.64	.24	.560

TABLE A- 6

W1/1.50/C-0.18/5:1

No.	Q _M (cfs)	Q _P (cfs)	H _M (ft)	H _P (ft)	A _P (ft ²)	V _P (ft/sec)	H _V (ft)	H _T (ft)	Y _N (ft)	Y _C (ft)	F	C _d
1	28.08	1569.46	.885	4.43	93.37	16.81	4.900	9.33	3.64	6.29	1.92	.347
2	20.27	1133.02	.800	4.00	79.16	14.31	3.553	7.55	3.12	5.33	1.71	.425
3	14.46	808.29	.701	3.51	63.97	12.64	2.769	6.27	2.66	4.49	1.60	.482
4	9.06	506.39	.565	2.83	45.50	11.13	2.148	4.97	2.14	3.55	1.55	.540
5	9.06	506.39	.565	2.83	45.50	11.13	2.148	4.97	2.14	3.55	1.55	.540
6	8.76	489.62	.560	2.80	44.88	10.91	2.064	4.86	2.11	3.49	1.53	.551
7	7.76	433.52	.534	2.67	41.68	10.40	1.876	4.55	1.99	3.28	1.49	.578
8	5.42	303.12	.457	2.29	32.82	9.24	1.480	3.76	1.68	2.74	1.42	.648
9	3.94	220.10	.415	2.08	28.35	7.76	1.045	3.12	1.45	2.33	1.24	.752
10	2.13	119.16	.323	1.62	19.50	6.11	.647	2.26	1.09	1.72	1.10	.910
11	2.00	111.93	.315	1.58	18.80	5.96	.615	2.19	1.06	1.66	1.08	.927
12	1.86	104.14	.314	1.57	18.71	5.57	.537	2.11	1.02	1.60	1.01	.949
13	1.36	76.17	.299	1.50	17.41	4.38	.332	1.83	.89	1.37	.81	.992
14	1.26	70.41	.289	1.45	16.56	4.25	.314	1.76	.85	1.32	.80	1.009
15	.98	54.59	.254	1.27	13.70	3.98	.275	1.55	.76	1.16	.80	1.081
16	.64	35.67	.227	1.14	11.62	3.07	.163	1.30	.62	.94	.65	1.091
17	.34	18.79	.194	.97	9.24	2.03	.072	1.04	.46	.68	.47	.997
18	.37	20.81	.194	.97	9.24	2.25	.088	1.06	.49	.72	.52	1.062
19	.25	13.71	.173	.87	7.80	1.76	.054	.92	.40	.58	.43	.996

TABLE A- 7

W1/0.50/C-0.702/5:1

No.	Q_M (cfs)	Q_P (cfs)	H_M (ft)	H_P (ft)	A_P (ft ²)	V_P (ft/sec)	H_V (ft)	H_T (ft)	Y_N (ft)	Y_C (ft)	F	C_d
1	19.05	1064.95	1.149	5.75	172.34	6.18	.662	6.41	3.93	5.15	.60	.602
2	17.92	1001.83	1.142	5.71	170.72	5.87	.597	6.31	3.81	5.00	.57	.589
3	9.83	549.62	.940	4.70	127.12	4.32	.324	5.02	2.88	3.69	.45	.571
4	8.86	495.55	.892	4.46	117.67	4.21	.308	4.77	2.74	3.50	.45	.587
5	8.42	470.48	.879	4.40	115.16	4.09	.289	4.68	2.67	3.41	.44	.582
6	6.10	340.74	.792	3.96	99.07	3.44	.205	4.17	2.30	2.90	.39	.566
7	4.33	241.80	.696	3.48	82.63	2.93	.149	3.63	1.96	2.44	.34	.567
8	2.74	152.93	.584	2.92	35.20	2.35	.095	3.02	1.58	1.94	.29	.569
9	2.17	121.45	.547	2.74	59.86	2.03	.071	2.81	1.42	1.73	.26	.541
10	2.13	119.13	.543	2.72	59.29	2.01	.070	2.79	1.41	1.71	.26	.541
11	1.55	86.53	.478	2.39	50.44	1.72	.051	2.44	1.21	1.46	.23	.546
12	.51	28.53	.299	1.50	29.33	.97	.016	1.51	.72	.84	.15	.597
13	.38	20.99	.270	1.35	26.36	.80	.011	1.36	.63	.72	.13	.571
14	.34	18.77	.257	1.29	25.07	.75	.010	1.29	.60	.68	.12	.578
15	.28	15.63	.234	1.17	22.85	.68	.008	1.18	.55	.62	.12	.610
16	.14	8.03	.177	.88	17.70	.45	.004	.89	.40	.44	.08	.634

TABLE A- 8

W1/0.50/C-1.229/5:1

No.	Q_M (cfs)	Q_P (cfs)	H_M (ft)	H_P (ft)	A_P (ft ²)	V_P (ft/sec)	H_V (ft)	H_T (ft)	Y_N (ft)	Y_C (ft)	F	C_d
1	15.19	849.06	1.153	5.77	198.61	4.27	.317	6.08	3.53	4.60	.40	.547
2	13.01	727.16	1.098	5.49	185.18	3.93	.267	5.76	3.28	4.25	.37	.537
3	11.04	617.20	1.023	5.12	167.59	3.68	.235	5.35	3.04	3.91	.36	.548
4	8.88	496.39	.914	4.57	143.53	3.46	.207	4.78	2.74	3.51	.35	.585
5	8.85	494.71	.931	4.66	147.16	3.36	.196	4.85	2.74	3.50	.34	.561
6	8.65	483.61	.922	4.61	145.23	3.33	.192	4.80	2.71	3.46	.34	.562
7	7.55	421.80	.876	4.38	135.56	3.11	.168	4.55	2.54	3.23	.32	.562
8	6.86	383.42	.834	4.17	127.00	3.02	.158	4.33	2.43	3.08	.32	.578
9	5.42	303.12	.764	3.82	113.33	2.67	.124	3.94	2.18	2.74	.29	.577
10	4.45	248.62	.711	3.56	103.47	2.40	.100	3.66	1.98	2.48	.27	.572
11	4.26	238.33	.701	3.51	101.66	2.34	.095	3.60	1.94	2.42	.26	.569
12	4.00	223.87	.686	3.43	98.97	2.26	.089	3.52	1.89	2.35	.25	.566
13	2.16	120.99	.550	2.75	76.10	1.59	.044	2.79	1.42	1.72	.19	.545
14	1.83	102.25	.515	2.58	70.66	1.45	.036	2.61	1.31	1.58	.18	.545
15	.38	21.02	.279	1.40	38.80	.54	.005	1.40	.63	.72	.08	.533
16	.36	20.29	.276	1.38	38.45	.53	.005	1.38	.62	.70	.08	.528
17	.26	14.32	.247	1.24	35.12	.41	.003	1.24	.53	.59	.06	.494

TABLE A- 9

W1/0.50/C-1.756/5:1

No.	Q_M (cfs)	Q_P (cfs)	H_M (ft)	H_P (ft)	A_P (ft ²)	V_P (ft/sec)	H_V (ft)	H_T (ft)	Y_N (ft)	Y_C (ft)	F	C_d
1	24.35	1361.10	1.405	7.03	296.97	4.58	.364	7.39	4.41	5.83	.39	.539
2	19.82	1108.05	1.310	6.55	268.96	4.12	.294	6.84	4.00	5.26	.36	.531
3	19.12	1068.71	1.288	6.44	262.66	4.07	.287	6.73	3.93	5.16	.35	.535
4	15.05	841.37	1.176	5.88	231.74	3.63	.229	6.11	3.51	4.57	.33	.536
5	8.82	493.02	.951	4.76	175.32	2.81	.137	4.89	2.73	3.49	.27	.547
6	8.21	458.79	.924	4.62	169.06	2.71	.128	4.75	2.64	3.37	.26	.549
7	6.90	385.59	.864	4.32	155.53	2.48	.107	4.43	2.44	3.09	.25	.550
8	4.96	277.21	.750	3.75	131.33	2.11	.077	3.83	2.09	2.62	.22	.568
9	2.18	121.68	.557	2.79	94.80	1.28	.029	2.81	1.42	1.73	.15	.538
10	2.17	121.45	.556	2.78	94.62	1.28	.029	2.81	1.42	1.73	.15	.540
11	2.10	117.25	.547	2.74	93.06	1.26	.028	2.76	1.40	1.70	.14	.543
12	1.45	80.83	.476	2.38	81.13	1.00	.017	2.40	1.18	1.41	.12	.534
13	1.13	63.23	.431	2.16	73.96	.85	.013	2.17	1.05	1.25	.10	.537
14	.59	33.18	.328	1.64	58.70	.57	.006	1.65	.78	.90	.07	.561
15	.38	21.14	.288	1.44	53.20	.40	.003	1.44	.63	.72	.05	.497
16	.37	20.83	.284	1.42	52.66	.40	.003	1.42	.63	.71	.05	.507
17	.36	20.01	.279	1.40	52.00	.38	.003	1.40	.62	.70	.05	.509
18	.32	18.03	.272	1.36	51.07	.35	.002	1.36	.59	.66	.05	.489
19	.24	13.68	.244	1.22	47.43	.29	.001	1.22	.52	.58	.04	.488
20	.09	4.78	.155	.78	36.64	.13	.000	.78	.32	.34	.02	.531

TABLE A-10

W1/0.00/C-0.176/1:1

No.	Q _M (cfs)	Q _P (cfs)	H _M (ft)	H _P (ft)	A _P (ft ²)	V _P (ft/sec)	H _V (ft)	H _T (ft)	Y _N (ft)	Y _C (ft)	F	C _d
1	7.69	7.69	.938	.94	5.44	1.41	.035	.97	INF.	.65	.32	.484
2	7.56	7.56	.912	.91	5.23	1.45	.036	.95	INF.	.65	.34	.508
3	7.46	7.46	.897	.90	5.11	1.46	.037	.93	INF.	.64	.34	.520
4	6.96	6.96	.878	.88	4.95	1.40	.034	.91	INF.	.62	.33	.514
5	5.04	5.04	.777	.78	4.18	1.20	.025	.80	INF.	.53	.30	.514
6	3.01	3.01	.670	.67	3.44	.88	.013	.68	INF.	.41	.23	.459
7	1.97	1.97	.580	.58	2.86	.69	.008	.59	INF.	.33	.19	.435
8	1.12	1.12	.465	.47	2.19	.51	.004	.47	INF.	.25	.15	.434
9	.67	.67	.377	.38	1.74	.38	.003	.38	INF.	.19	.12	.441
10	.36	.36	.307	.31	1.41	.26	.001	.31	INF.	.14	.09	.404
11	.25	.25	.267	.27	1.23	.20	.001	.27	INF.	.12	.07	.394
12	.16	.16	.218	.22	1.03	.16	.000	.22	INF.	.09	.06	.424
13	.10	.10	.179	.18	.88	.11	.000	.18	INF.	.07	.04	.436
14	.05	.05	.148	.15	.77	.07	.000	.15	INF.	.05	.03	.373

TABLE A-11

W1/0.50/C-0.176/1:1

No.	Q _M (cfs)	Q _P (cfs)	H _M (ft)	H _P (ft)	A _P (ft ²)	V _P (ft/sec)	H _V (ft)	H _T (ft)	Y _N (ft)	Y _C (ft)	F	C _d
1	14.53	14.53	1.170	1.17	7.05	2.06	.074	1.24	.78	.90	.44	.495
2	10.65	10.65	1.058	1.06	6.04	1.76	.054	1.11	.68	.77	.40	.480
3	8.86	8.86	.973	.97	5.32	1.67	.048	1.02	.62	.70	.39	.494
4	6.92	6.92	.895	.90	4.70	1.47	.038	.93	.55	.62	.35	.484
5	4.90	4.90	.785	.79	3.88	1.26	.028	.81	.47	.52	.32	.484
6	4.10	4.10	.751	.75	3.65	1.13	.022	.77	.43	.48	.29	.459
7	2.69	2.69	.642	.64	2.93	.92	.015	.66	.36	.38	.25	.452
8	1.52	1.52	.521	.52	2.22	.68	.008	.53	.27	.29	.20	.438
9	.74	.74	.399	.40	1.60	.46	.004	.40	.20	.20	.15	.425
10	.38	.38	.314	.31	1.22	.31	.002	.32	.14	.14	.11	.400
11	.11	.11	.188	.19	.73	.15	.000	.19	.08	.08	.06	.427
12	.06	.06	.143	.14	.58	.10	.000	.14	.06	.06	.05	.458

TABLE A-12

W1/1.00/C-0.176/1:1

No.	Q_M (cfs)	Q_P (cfs)	H_M (ft)	H_P (ft)	A_P (ft ²)	V_P (ft/sec)	H_V (ft)	H_T (ft)	Y_N (ft)	Y_C (ft)	F	C_d
1	11.48	11.48	.923	.92	4.53	2.54	.112	1.03	.60	.80	.61	.620
2	9.01	9.01	.872	.87	4.15	2.17	.082	.95	.53	.71	.54	.596
3	9.01	9.01	.848	.85	3.97	2.27	.089	.94	.53	.71	.57	.623
4	8.43	8.43	.824	.82	3.80	2.22	.085	.91	.52	.68	.56	.629
5	7.63	7.63	.793	.79	3.59	2.13	.078	.87	.49	.65	.55	.633
6	7.13	7.13	.780	.78	3.50	2.03	.072	.85	.48	.63	.53	.625
7	6.27	6.27	.755	.76	3.34	1.88	.061	.82	.45	.59	.49	.612
8	5.37	5.37	.723	.72	3.13	1.72	.051	.77	.42	.55	.46	.599
9	4.42	4.42	.728	.73	3.16	1.40	.034	.76	.38	.49	.37	.512
10	2.21	2.21	.588	.59	2.32	.95	.016	.60	.28	.35	.28	.459
11	.79	.79	.401	.40	1.38	.57	.006	.41	.17	.21	.19	.441
12	.39	.39	.314	.31	1.01	.38	.003	.32	.12	.15	.14	.406
13	.26	.26	.265	.27	.83	.31	.002	.27	.10	.12	.12	.416
14	.15	.15	.209	.21	.63	.24	.001	.21	.08	.09	.10	.436
15	.09	.09	.164	.16	.49	.18	.001	.16	.06	.07	.08	.466
16	.06	.06	.132	.13	.39	.15	.000	.13	.05	.06	.08	.557

TABLE A-13

W1/1.50/C-0.176/1:1

No.	Q _M (cfs)	Q _P (cfs)	H _M (ft)	H _P (ft)	A _P (ft ²)	V _P (ft/sec)	H _V (ft)	H _T (ft)	Y _N (ft)	Y _C (ft)	F	C _d
1	29.63	29.63	1.024	1.02	4.92	6.02	.628	1.65	.85	1.29	1.43	.496
2	23.64	23.64	.988	.99	4.64	5.09	.450	1.44	.76	1.15	1.23	.560
3	19.16	19.16	.956	.96	4.40	4.35	.329	1.28	.69	1.04	1.07	.602
4	13.81	13.81	.739	.74	2.91	4.74	.389	1.13	.59	.88	1.30	.600
5	8.95	8.95	.738	.74	2.91	3.08	.165	.90	.48	.71	.84	.680
6	7.76	7.76	.681	.68	2.56	3.02	.159	.84	.45	.66	.86	.706
7	6.56	6.56	.621	.62	2.22	2.95	.151	.77	.42	.60	.87	.737
8	5.22	5.22	.573	.57	1.97	2.65	.122	.70	.37	.54	.81	.762
9	4.10	4.10	.546	.55	1.83	2.24	.087	.63	.34	.48	.70	.756
10	2.88	2.88	.514	.51	1.67	1.72	.051	.57	.28	.40	.55	.704
11	2.16	2.16	.490	.49	1.56	1.39	.033	.52	.25	.35	.45	.641
12	1.08	1.08	.408	.41	1.19	.91	.014	.42	.18	.24	.32	.549
13	.39	.39	.297	.30	.76	.51	.005	.30	.11	.15	.21	.460
14	.36	.36	.288	.29	.73	.50	.004	.29	.11	.14	.20	.461
15	.25	.25	.251	.25	.61	.42	.003	.25	.09	.12	.18	.457
16	.12	.12	.192	.19	.42	.27	.001	.19	.06	.08	.13	.413
17	.06	.06	.143	.14	.29	.19	.001	.14	.05	.06	.11	.421

TABLE A-14

W1/0.00/C-0.676/1:1

No.	Q_M (cfs)	Q_P (cfs)	H_M (ft)	H_P (ft)	A_P (ft ²)	V_P (ft/sec)	H_V (ft)	H_T (ft)	Y_N (ft)	Y_C (ft)	F	C_d
1	9.55	9.55	1.023	1.02	11.32	.84	.012	1.04	INF.	.73	.16	.515
2	8.30	8.30	.972	.97	10.72	.77	.010	.98	INF.	.68	.15	.510
3	7.72	7.72	.947	.95	10.44	.74	.009	.96	INF.	.65	.14	.507
4	7.01	7.01	.913	.91	10.05	.70	.008	.92	INF.	.62	.14	.506
5	6.70	6.70	.900	.90	9.91	.68	.008	.91	INF.	.61	.13	.501
6	5.89	5.89	.855	.86	9.42	.63	.007	.86	INF.	.57	.12	.502
7	4.17	4.17	.743	.74	8.25	.51	.004	.75	INF.	.48	.10	.507
8	3.01	3.01	.664	.66	7.47	.40	.003	.67	INF.	.41	.09	.488
9	2.03	2.03	.583	.58	6.71	.30	.002	.58	INF.	.33	.07	.457
10	1.15	1.15	.475	.48	5.75	.20	.001	.48	INF.	.25	.05	.435
11	.64	.64	.373	.37	4.91	.13	.000	.37	INF.	.19	.03	.440
12	.35	.35	.287	.29	4.26	.08	.000	.29	INF.	.14	.02	.467
13	.13	.13	.183	.18	3.52	.04	.000	.18	INF.	.09	.01	.551
14	.07	.07	.148	.15	3.29	.02	.000	.15	INF.	.06	.01	.465

TABLE A-15

W1/0.50/C-0.676/1:1

No.	Q_M (cfs)	Q_P (cfs)	H_M (ft)	H_P (ft)	A_P (ft ²)	V_P (ft/sec)	H_V (ft)	H_T (ft)	Y_N (ft)	Y_C (ft)	F	C_d
1	8.67	8.67	.996	1.00	10.42	.83	.012	1.01	.61	.69	.16	.499
2	8.65	8.65	.996	1.00	10.42	.83	.012	1.01	.61	.69	.16	.498
3	7.77	7.77	.953	.95	9.94	.78	.011	.96	.58	.66	.15	.501
4	7.33	7.33	.933	.93	9.72	.75	.010	.94	.57	.64	.15	.499
5	6.66	6.66	.952	.95	9.93	.67	.008	.96	.54	.61	.13	.434
6	5.92	5.92	.857	.86	8.91	.66	.008	.86	.51	.57	.13	.500
7	5.09	5.09	.812	.81	8.44	.60	.006	.82	.48	.53	.12	.494
8	3.87	3.87	.737	.74	7.69	.50	.004	.74	.42	.46	.11	.480
9	1.17	1.17	.459	.46	5.20	.22	.001	.46	.24	.25	.05	.480
10	.39	.39	.313	.31	4.08	.09	.000	.31	.14	.15	.02	.414
11	.24	.24	.259	.26	3.70	.07	.000	.26	.12	.12	.02	.421
12	.06	.06	.198	.20	3.29	.02	.000	.20	.06	.06	.00	.204

TABLE A-16

W1/1.00/C-0.676/1:1

No.	Q_M (cfs)	Q_P (cfs)	H_M (ft)	H_P (ft)	A_P (ft ²)	V_P (ft/sec)	H_V (ft)	H_T (ft)	Y_N (ft)	Y_C (ft)	F	C_d
1	19.41	19.41	1.331	1.33	13.90	1.40	.034	1.36	.76	1.04	.25	.524
2	13.94	13.94	1.188	1.19	12.09	1.15	.023	1.21	.65	.88	.22	.508
3	8.95	8.95	1.002	1.00	9.93	.90	.014	1.02	.53	.71	.18	.506
4	8.37	8.37	.975	.98	9.64	.87	.013	.99	.51	.68	.17	.507
5	7.93	7.93	.959	.96	9.46	.84	.012	.97	.50	.66	.17	.501
6	7.03	7.03	.914	.91	8.98	.78	.011	.92	.47	.62	.16	.503
7	5.20	5.20	.815	.82	7.97	.65	.007	.82	.41	.54	.14	.498
8	3.47	3.47	.698	.70	6.84	.51	.004	.70	.34	.44	.11	.493
9	2.18	2.18	.596	.60	5.93	.37	.002	.60	.27	.35	.08	.463
10	1.35	1.35	.514	.51	5.24	.26	.001	.52	.22	.27	.06	.416
11	.56	.56	.341	.34	3.92	.14	.000	.34	.15	.18	.04	.485
12	.27	.27	.271	.27	3.44	.08	.000	.27	.10	.12	.02	.409
13	.06	.06	.192	.19	2.93	.02	.000	.19	.05	.06	.01	.204

TABLE A-17

W1/1.50/C-0.676/1:1

No.	Q_M (cfs)	Q_P (cfs)	H_M (ft)	H_P (ft)	A_P (ft ²)	V_P (ft/sec)	H_V (ft)	H_T (ft)	Y_N (ft)	Y_C (ft)	F	C_d
1	12.87	12.87	1.127	1.13	10.78	1.19	.025	1.15	.57	.85	.23	.531
2	9.07	9.07	1.003	1.00	9.40	.97	.016	1.02	.49	.71	.19	.508
3	8.40	8.40	.971	.97	9.05	.93	.015	.99	.47	.68	.19	.511
4	7.69	7.69	.946	.95	8.79	.87	.013	.96	.45	.65	.18	.501
5	5.92	5.92	.858	.86	7.90	.75	.010	.87	.40	.57	.16	.496
6	3.62	3.62	.713	.71	6.52	.55	.005	.72	.32	.45	.12	.486
7	2.01	2.01	.575	.58	5.33	.38	.002	.58	.24	.33	.09	.467
8	1.35	1.35	.483	.48	4.60	.29	.001	.48	.20	.27	.07	.485
9	.39	.39	.332	.33	3.52	.11	.000	.33	.11	.15	.03	.358
10	.16	.16	.238	.24	2.91	.05	.000	.24	.07	.09	.01	.337
11	.05	.05	.130	.13	2.27	.02	.000	.13	.04	.05	.01	.493

TABLE A-18

W2/0.00/C-0.186/1:1

No.	Q_M (cfs)	Q_P (cfs)	H_M (ft)	H_P (ft)	A_P (ft ²)	V_P (ft/sec)	H_V (ft)	H_T (ft)	Y_N (ft)	Y_C (ft)	F	C_d
1	7.29	7.29	1.093	1.09	6.89	1.06	.019	1.11	INF.	.63	.23	.493
2	4.85	4.85	.935	.94	5.50	.88	.013	.95	INF.	.52	.20	.488
3	3.31	3.31	.807	.81	4.48	.74	.009	.82	INF.	.43	.18	.484
4	2.12	2.12	.695	.70	3.67	.58	.006	.70	INF.	.34	.15	.454
5	1.69	1.69	.636	.64	3.28	.51	.005	.64	INF.	.30	.14	.453
6	1.15	1.15	.562	.56	2.81	.41	.003	.56	INF.	.25	.11	.422
7	.45	.45	.430	.43	2.06	.22	.001	.43	INF.	.16	.07	.328
8	.33	.33	.339	.34	1.60	.21	.001	.34	INF.	.13	.07	.434
9	.35	.35	.346	.35	1.63	.21	.001	.35	INF.	.14	.07	.434
10	.26	.26	.305	.31	1.44	.18	.001	.31	INF.	.12	.06	.440
11	.16	.16	.276	.28	1.31	.12	.000	.28	INF.	.09	.04	.341
12	.14	.14	.255	.26	1.22	.12	.000	.26	INF.	.09	.04	.385
13	.09	.09	.186	.19	.94	.09	.000	.19	INF.	.07	.04	.522

TABLE A-19

W2/0.50/C-0.186/1:1

No.	Q_M (cfs)	Q_P (cfs)	H_M (ft)	H_P (ft)	A_P (ft ²)	V_P (ft/sec)	H_V (ft)	H_T (ft)	Y_N (ft)	Y_C (ft)	F	C_d
1	8.03	8.03	1.129	1.13	6.76	1.19	.024	1.15	.59	.67	.26	.495
2	4.62	4.62	.924	.92	5.00	.92	.015	.94	.46	.50	.22	.477
3	2.16	2.16	.706	.71	3.41	.63	.007	.71	.32	.34	.17	.444
4	.79	.79	.476	.48	2.04	.39	.003	.48	.20	.21	.12	.440
5	.38	.38	.361	.36	1.47	.26	.001	.36	.14	.14	.09	.428
6	.18	.18	.270	.27	1.08	.16	.000	.27	.10	.10	.06	.407
7	.05	.05	.188	.19	.77	.07	.000	.19	.06	.05	.03	.308

TABLE A-20

W2/1.00/C-0.186/1:1

No.	Q _M (cfs)	Q _P (cfs)	H _M (ft)	H _P (ft)	A _P (ft ²)	V _P (ft/sec)	H _V (ft)	H _T (ft)	Y _N (ft)	Y _C (ft)	F	C _d
1	9.22	9.22	1.144	1.14	6.44	1.43	.036	1.18	.54	.72	.32	.538
2	5.42	5.42	.974	.97	5.00	1.08	.020	.99	.42	.55	.26	.485
3	3.39	3.39	.814	.81	3.80	.89	.014	.83	.34	.43	.23	.479
4	2.24	2.24	.707	.71	3.09	.73	.009	.72	.28	.35	.19	.455
5	1.19	1.19	.552	.55	2.18	.55	.005	.56	.21	.26	.16	.451
6	.45	.45	.376	.38	1.31	.35	.002	.38	.13	.16	.12	.454
7	.39	.39	.360	.36	1.24	.31	.002	.36	.12	.15	.11	.434
8	.18	.18	.265	.27	.86	.21	.001	.27	.09	.10	.08	.432
9	.06	.06	.180	.18	.57	.10	.000	.18	.05	.06	.05	.373

TABLE A-21

W2/1.50/C-0.186/1:1

No.	Q _M (cfs)	Q _P (cfs)	H _M (ft)	H _P (ft)	A _P (ft ²)	V _P (ft/sec)	H _V (ft)	H _T (ft)	Y _N (ft)	Y _C (ft)	F	C _d
1	8.73	8.73	1.090	1.09	5.54	1.58	.043	1.13	.48	.70	.36	.563
2	7.49	7.49	.990	.99	4.73	1.58	.043	1.03	.44	.65	.38	.608
3	4.14	4.14	.822	.82	3.52	1.18	.024	.85	.34	.48	.31	.554
4	2.10	2.10	.676	.68	2.59	.81	.011	.69	.25	.34	.23	.473
5	1.86	1.86	.640	.64	2.39	.78	.011	.65	.23	.32	.23	.481
6	.83	.83	.464	.46	1.48	.56	.005	.47	.16	.21	.18	.482
7	.35	.35	.350	.35	1.00	.35	.002	.35	.11	.14	.13	.416
8	.09	.09	.175	.18	.40	.22	.001	.18	.06	.07	.11	.602
9	.06	.06	.134	.13	.29	.19	.001	.13	.05	.06	.11	.742

TABLE A-22

W2/0.00/C-0.676/1:1

No.	Q _M (cfs)	Q _P (cfs)	H _M (ft)	H _P (ft)	A _P (ft ²)	V _P (ft/sec)	H _V (ft)	H _T (ft)	Y _N (ft)	Y _C (ft)	F	C _d
1	7.99	7.99	1.132	1.13	12.64	.63	.007	1.14	INF.	.66	.12	.509
2	7.40	7.40	1.099	1.10	12.23	.61	.006	1.11	INF.	.64	.11	.508
3	5.69	5.69	.996	1.00	11.00	.52	.005	1.00	INF.	.56	.10	.501
4	3.43	3.43	.816	.82	9.00	.38	.003	.82	INF.	.43	.08	.499
5	2.07	2.07	.682	.68	7.64	.27	.001	.68	INF.	.34	.06	.472
6	1.15	1.15	.534	.53	6.26	.18	.001	.53	INF.	.25	.04	.487
7	.55	.55	.398	.40	5.11	.11	.000	.40	INF.	.17	.02	.480
8	.36	.36	.354	.35	4.77	.08	.000	.35	INF.	.14	.02	.428
9	.23	.23	.297	.30	4.33	.05	.000	.30	INF.	.11	.01	.428
10	.10	.10	.193	.19	3.59	.03	.000	.19	INF.	.07	.01	.551
11	.06	.06	.143	.14	3.26	.02	.000	.14	INF.	.06	.00	.665

TABLE A-23

W2/0.50/C-0.676/1:1

No.	Q _M (cfs)	Q _P (cfs)	H _M (ft)	H _P (ft)	A _P (ft ²)	V _P (ft/sec)	H _V (ft)	H _T (ft)	Y _N (ft)	Y _C (ft)	F	C _d
1	8.80	8.80	1.174	1.17	12.54	.70	.009	1.18	.62	.70	.13	.510
2	7.15	7.15	1.086	1.09	11.47	.62	.007	1.09	.56	.63	.12	.505
3	5.37	5.37	.972	.97	10.15	.53	.005	.98	.49	.54	.10	.502
4	2.92	2.92	.773	.77	8.05	.36	.002	.78	.37	.40	.08	.487
5	2.16	2.16	.699	.70	7.32	.29	.002	.70	.32	.34	.06	.463
6	2.15	2.15	.692	.69	7.26	.30	.002	.69	.32	.34	.06	.473
7	1.01	1.01	.521	.52	5.72	.18	.001	.52	.23	.24	.04	.455
8	.49	.49	.377	.38	4.56	.11	.000	.38	.16	.16	.03	.496
9	.38	.38	.358	.36	4.41	.09	.000	.36	.14	.14	.02	.432
10	.19	.19	.267	.27	3.76	.05	.000	.27	.10	.10	.01	.463
11	.06	.06	.161	.16	3.05	.02	.000	.16	.06	.06	.01	.494

TABLE A-24

W2/1.00/C-0.676/1:1

No.	Q _M (cfs)	Q _P (cfs)	H _M (ft)	H _P (ft)	A _P (ft ²)	V _P (ft/sec)	H _V (ft)	H _T (ft)	Y _N (ft)	Y _C (ft)	F	C _d
1	9.18	9.18	1.191	1.19	12.13	.76	.010	1.20	.54	.71	.14	.512
2	7.35	7.35	1.092	1.09	10.95	.67	.008	1.10	.48	.64	.13	.511
3	5.45	5.45	.975	.98	9.64	.57	.006	.98	.42	.55	.11	.504
4	3.73	3.73	.853	.85	8.35	.45	.003	.86	.35	.45	.09	.484
5	2.64	2.64	.727	.73	7.11	.37	.002	.73	.30	.38	.08	.511
6	2.23	2.23	.702	.70	6.88	.32	.002	.70	.28	.35	.07	.473
7	1.03	1.03	.513	.51	5.24	.20	.001	.51	.19	.24	.05	.480
8	.39	.39	.350	.35	3.99	.10	.000	.35	.12	.15	.02	.472
9	.39	.39	.366	.37	4.10	.09	.000	.37	.12	.15	.02	.420
10	.19	.19	.254	.25	3.33	.06	.000	.25	.09	.10	.02	.526
11	.11	.11	.207	.21	3.03	.04	.000	.21	.07	.08	.01	.479
12	.05	.05	.136	.14	2.59	.02	.000	.14	.05	.05	.01	.627

TABLE A-25

W2/1.50/C-0.676/1:1

No.	Q _M (cfs)	Q _P (cfs)	H _M (ft)	H _P (ft)	A _P (ft ²)	V _P (ft/sec)	H _V (ft)	H _T (ft)	Y _N (ft)	Y _C (ft)	F	C _d
1	9.39	9.39	1.204	1.20	11.08	.80	.011	1.22	.49	.72	.15	.509
2	8.73	8.73	1.172	1.17	11.30	.77	.010	1.18	.48	.70	.15	.506
3	7.74	7.74	1.122	1.12	10.72	.72	.009	1.13	.45	.66	.14	.501
4	5.45	5.45	.972	.97	9.07	.60	.006	.98	.38	.55	.12	.507
5	2.42	2.42	.710	.71	6.50	.37	.002	.71	.26	.37	.08	.499
6	2.26	2.26	.707	.71	6.47	.35	.002	.71	.25	.35	.08	.471
7	1.13	1.13	.534	.53	5.00	.23	.001	.53	.18	.25	.05	.477
8	.43	.43	.351	.35	3.65	.12	.000	.35	.12	.15	.03	.521
9	.39	.39	.352	.35	3.65	.11	.000	.35	.11	.15	.03	.471
10	.15	.15	.234	.23	2.88	.05	.000	.23	.07	.09	.01	.510
11	.11	.11	.210	.21	2.74	.04	.000	.21	.06	.08	.01	.462

TABLE A-26

W2/0.00/C-0.00:PROTO/1:1

No.	Q _M (cfs)	Q _P (cfs)	H _M (ft)	H _P (ft)	A _P (ft ²)	V _P (ft/sec)	H _V (ft)	H _T (ft)	Y _N (ft)	Y _C (ft)	F	C _d
1	2.04	2.04	.703	.70	4.55	.45	.0003	.71	INF.	.24	.12	.429
2	.88	.88	.507	.51	2.79	.31	.002	.51	INF.	.16	.10	.420
3	.37	.37	.374	.37	1.77	.21	.001	.37	INF.	.10	.08	.381
4	.12	.12	.252	.25	.98	.13	.000	.25	INF.	.06	.06	.340

TABLE A-27

W2/0.50/C-0.00:PROTO/1:1

No.	Q _M (cfs)	Q _P (cfs)	H _M (ft)	H _P (ft)	A _P (ft ²)	V _P (ft/sec)	H _V (ft)	H _T (ft)	Y _N (ft)	Y _C (ft)	F	C _d
1	2.20	2.20	.717	.72	4.21	.52	.005	.72	.24	.25	.15	.438
2	1.15	1.15	.558	.56	2.80	.41	.003	.56	.18	.18	.13	.432
3	.38	.38	.375	.38	1.44	.27	.001	.38	.11	.11	.11	.390
4	.09	.09	.211	.21	.50	.18	.001	.21	.06	.05	.10	.386

TABLE A-28

W2/1.00/C-0.00:PROTO/1:1

No.	Q _M (cfs)	Q _P (cfs)	H _M (ft)	H _P (ft)	A _P (ft ²)	V _P (ft/sec)	H _V (ft)	H _T (ft)	Y _N (ft)	Y _C (ft)	F	C _d
1	2.25	2.25	.713	.71	3.71	.60	.006	.72	.21	.26	.18	.451
2	.93	.93	.520	.52	2.11	.44	.003	.52	.14	.17	.16	.413
3	.39	.39	.374	.37	1.11	.35	.002	.38	.09	.11	.15	.395
4	.14	.14	.248	.25	.44	.32	.002	.25	.06	.06	.19	.399

TABLE A-29

W2/1.50/C-0.00:PROTO/1:1

No.	Q _M (cfs)	Q _P (cfs)	H _M (ft)	H _P (ft)	A _P (ft ²)	V _P (ft/sec)	H _V (ft)	H _T (ft)	Y _N (ft)	Y _C (ft)	F	C _d
1	2.02	2.02	.642	.64	2.67	.76	.010	.65	.18	.24	.25	.520
2	.39	.39	.361	.36	.75	.51	.005	.37	.08	.11	.26	.420
3	.06	.06	.192	.19	.07	.90	.014	.21	.04	.04	1.01	.276

TABLE A-30

W1/0.0//T-0.00(5:1)/5:1

No.	Q _M (cfs)	Q _P (cfs)	H _M (ft)	H _P (ft)	A _P (ft ²)	V _P (ft/sec)	H _V (ft)	H _T (ft)	Y _N (ft)	Y _C (ft)	F	C _d
1	17.74	991.4	1.127	5.64	186.94	5.30	.488	6.12	INF.	4.40	.57	.628
2	12.28	686.32	.982	4.91	145.09	4.73	.388	5.30	INF.	3.74	.54	.624
3	8.82	493.02	.864	4.32	114.91	4.29	.319	4.64	INF.	3.22	.52	.625
4	5.52	308.58	.726	3.63	84.03	3.67	.234	3.86	INF.	2.60	.48	.618
5	2.74	152.93	.555	2.78	52.38	2.92	.148	2.92	INF.	1.87	.43	.615
6	1.32	73.54	.422	2.11	32.81	2.24	.087	2.20	INF.	1.30	.37	.604
7	.79	44.24	.347	1.74	23.73	1.86	.060	1.80	INF.	1.01	.34	.602
8	.38	21.16	.263	1.32	15.22	1.39	.034	1.35	INF.	.68	.28	.589
9	.18	10.15	.189	.94	9.19	1.10	.021	.97	INF.	.45	.26	.650
10	.09	4.95	.144	.72	6.19	.80	.011	.73	INF.	.29	.21	.637

TABLE A-31

W1/0.50/T-0.00(5:1)/5:1

No.	Q _M (cfs)	Q _P (cfs)	H _M (ft)	H _P (ft)	A _P (ft ²)	V _P (ft/sec)	H _V (ft)	H _T (ft)	Y _N (ft)	Y _C (ft)	F	C _d
1	10.00	558.86	.888	4.44	118.31	4.72	.387	4.83	2.75	3.41	.57	.642
2	3.97	221.99	.635	3.18	64.45	3.44	.206	3.38	1.83	2.23	.48	.621
3	2.22	124.17	.523	2.62	45.72	2.72	.128	2.74	1.40	1.69	.42	.586
4	1.15	64.56	.399	2.00	28.64	2.25	.088	2.08	1.03	1.22	.39	.608
5	.55	30.48	.295	1.48	17.28	1.76	.054	1.53	.71	.83	.35	.620
6	.22	12.26	.201	1.01	9.34	1.31	.030	1.03	.44	.50	.31	.661
7	.11	6.00	.139	.69	5.31	1.13	.022	.72	.30	.33	.31	.809

TABLE A-32

W1/1.0 /T-0.00(5:1)/5:1

No.	Q _M (cfs)	Q _P (cfs)	H _M (ft)	H _P (ft)	A _P (ft ²)	V _P (ft/sec)	H _V (ft)	H _T (ft)	Y _N (ft)	Y _C (ft)	F	C _d
1	17.27	965.33	.947	4.74	130.59	7.39	.948	5.68	2.99	4.36	.87	.737
2	9.19	513.76	.704	3.52	75.58	6.80	.801	4.32	2.28	3.29	.92	.778
3	5.30	296.15	.594	2.97	55.53	5.33	.493	3.46	1.78	2.56	.78	.780
4	3.14	175.80	.500	2.50	40.80	4.31	.322	2.82	1.40	2.00	.68	.772
5	1.63	90.95	.410	2.05	28.76	3.16	.173	2.22	1.02	1.45	.55	.725
6	.98	54.59	.354	1.77	22.29	2.45	.104	1.87	.80	1.12	.45	.667
7	.29	16.25	.222	1.11	10.15	1.60	.044	1.15	.42	.59	.37	.667
8	.16	9.08	.170	.85	6.56	1.38	.033	.88	.31	.42	.36	.728
9	.09	4.95	.135	.68	4.53	1.09	.021	.70	.22	.29	.32	.721

TABLE A-33

W1/1.50/T-0.00(5:1)/5:1

No.	Q _M (cfs)	Q _P (cfs)	H _M (ft)	H _P (ft)	A _P (ft ²)	V _P (ft/sec)	H _V (ft)	H _T (ft)	Y _N (ft)	Y _C (ft)	F	C _d
1	22.15	1237.95	.874	4.37	110.14	11.24	2.191	6.56	3.05	4.86	1.38	.660
2	16.71	934.11	.774	3.87	87.79	10.64	1.963	5.83	2.70	4.30	1.38	.668
3	9.25	517.00	.600	3.00	54.86	9.42	1.540	4.54	2.09	3.30	1.38	.692
4	5.85	326.98	.473	2.37	35.61	9.18	1.463	3.83	1.70	2.68	1.50	.670
5	3.62	202.31	.404	2.02	26.83	7.54	.986	3.01	1.36	2.14	1.33	.759
6	2.26	126.39	.375	1.88	23.50	5.38	.502	2.38	1.09	1.71	.98	.853
7	1.19	66.71	.279	1.40	13.98	4.77	.395	1.79	.80	1.25	1.00	.914
8	.78	43.60	.259	1.30	12.28	3.55	.219	1.51	.64	1.00	.77	.909
9	.28	15.42	.189	.94	7.14	2.16	.081	1.03	.37	.57	.55	.850
10	.16	9.13	.153	.77	4.97	1.84	.059	.82	.28	.42	.52	.871

TABLE A-34

W1/0.50/T(5:1)-0.500/5:1

No.	Q _M (cfs)	Q _P (cfs)	H _M (ft)	H _P (ft)	A _P (ft ²)	V _P (ft/sec)	H _V (ft)	H _T (ft)	Y _N (ft)	Y _C (ft)	F	C _d
1	9.09	508.04	.916	4.58	151.65	3.35	.195	4.77	2.64	3.27	.38	.599
2	5.87	328.25	.777	3.89	115.64	2.84	.140	4.02	2.18	2.68	.34	.594
3	3.14	175.80	.615	3.08	79.75	2.20	.084	3.16	1.65	2.00	.29	.582
4	1.42	79.42	.459	2.30	51.40	1.55	.041	2.34	1.13	1.36	.23	.559
5	.51	28.53	.305	1.53	29.38	.97	.016	1.54	.68	.80	.17	.568
6	.26	14.38	.239	1.20	21.76	.66	.008	1.20	.48	.55	.12	.533
7	.14	7.88	.185	.93	16.33	.48	.004	.93	.35	.39	.10	.557
8	.07	3.84	.134	.67	11.87	.32	.002	.67	.23	.25	.07	.609

TABLE A-35

W1/0.50/T(5:1)-1.000/5:1

No.	Q _M (cfs)	Q _P (cfs)	H _M (ft)	H _P (ft)	A _P (ft ²)	V _P (ft/sec)	H _V (ft)	H _T (ft)	Y _N (ft)	Y _C (ft)	F	C _d
1	7.46	416.82	.858	4.29	136.03	3.06	.163	4.45	2.57	3.20	.34	.585
2	3.66	204.36	.654	3.27	92.33	2.21	.085	3.35	1.86	2.29	.27	.583
3	2.37	132.44	.549	2.75	73.09	1.81	.057	2.80	1.52	1.85	.23	.592
4	1.17	65.43	.431	2.16	54.09	1.21	.025	2.18	1.08	1.30	.17	.548
5	.43	24.16	.296	1.48	35.77	.68	.008	1.49	.65	.76	.10	.526
6	.11	6.00	.159	.80	20.91	.29	.001	.80	.30	.34	.05	.622

TABLE A-36

W2/0.00/T-0.00(4:1)/5:1

No.	Q _M (cfs)	Q _P (cfs)	H _M (ft)	H _P (ft)	A _P (ft ²)	V _P (ft/sec)	H _V (ft)	H _T (ft)	Y _N (ft)	Y _C (ft)	F	C _d
1	8.71	487.05	1.088	5.44	145.57	3.35	.194	5.63	INF.	3.44	.36	.570
2	6.20	346.81	.959	4.80	115.94	2.99	.155	4.95	INF.	2.94	.34	.561
3	4.65	260.11	.854	4.27	94.28	2.76	.132	4.40	INF.	2.56	.33	.564
4	2.64	147.37	.694	3.47	65.51	2.25	.088	3.56	INF.	1.95	.30	.544
5	2.16	120.76	.653	3.27	58.97	2.05	.073	3.34	INF.	1.77	.28	.523
6	1.54	86.20	.576	2.88	47.58	1.81	.057	2.94	INF.	1.49	.26	.514
7	.64	35.67	.411	2.06	27.17	1.31	.030	2.08	INF.	.94	.22	.501
8	.37	20.91	.342	1.71	20.25	1.03	.018	1.73	INF.	.70	.18	.469
9	.09	5.19	.199	1.00	8.94	.58	.006	1.00	INF.	.31	.13	.457
10	.05	2.86	.154	.77	6.22	.46	.004	.77	INF.	.21	.11	.479

TABLE A-37

W2/0.50/T-0.00(4:1)/5:1

No.	Q _M (cfs)	Q _P (cfs)	H _M (ft)	H _P (ft)	A _P (ft ²)	V _P (ft/sec)	H _V (ft)	H _T (ft)	Y _N (ft)	Y _C (ft)	F	C _d
1	22.27	1244.98	1.543	7.72	273.33	4.55	.360	8.07	4.13	5.25	.42	.592
2	13.20	737.90	1.266	6.33	189.15	3.90	.264	6.59	3.30	4.16	.39	.583
3	8.97	501.42	1.086	5.43	142.68	3.51	.214	5.64	2.79	3.49	.38	.584
4	4.39	245.23	.826	4.13	86.99	2.82	.138	4.27	2.03	2.50	.35	.574
5	2.22	123.94	.648	3.24	56.65	2.19	.083	3.32	1.47	1.79	.30	.543
6	1.01	56.63	.478	2.39	33.60	1.69	.049	2.44	1.00	1.20	.26	.537
7	.49	27.50	.354	1.77	20.43	1.35	.031	1.80	.69	.81	.24	.557
8	.10	5.65	.199	1.00	8.30	.68	.008	1.00	.29	.32	.16	.494
9	.25	13.89	.290	1.45	14.84	.94	.015	1.47	.48	.55	.18	.471
10	.05	2.56	.134	.67	4.64	.55	.005	.68	.18	.20	.15	.601

TABLE A-38

W2/1.00/T-0.00(4:1)/5:1

No.	Q _M (cfs)	Q _P (cfs)	H _M (ft)	H _P (ft)	A _P (ft ²)	V _P (ft/sec)	H _V (ft)	H _T (ft)	Y _N (ft)	Y _C (ft)	F	C _d
1	18.36	1026.40	1.336	6.68	206.09	4.98	.430	7.11	3.28	4.82	.49	.671
2	11.87	663.57	1.085	5.43	140.05	4.74	.389	5.81	2.71	3.97	.52	.718
3	5.17	289.01	.826	4.13	85.11	3.40	.200	4.33	1.86	2.70	.42	.653
4	2.69	150.17	.655	3.28	56.20	2.67	.124	3.40	1.37	1.97	.37	.622
5	1.07	59.55	.477	2.39	32.31	1.84	.059	2.44	.86	1.24	.29	.562
6	.45	25.32	.356	1.78	19.69	1.29	.029	1.81	.55	.78	.23	.507
7	.22	12.23	.267	1.34	12.28	1.00	.017	1.35	.37	.51	.21	.507
8	.10	5.86	.199	1.00	7.68	.76	.010	1.01	.24	.33	.18	.510
9	.06	3.26	.154	.77	5.15	.63	.007	.78	.17	.23	.17	.540

TABLE A-39

W2/1.50/T-0.00(4:1)/5:1

No.	Q _M (cfs)	Q _P (cfs)	H _M (ft)	H _P (ft)	A _P (ft ²)	V _P (ft/sec)	H _V (ft)	H _T (ft)	Y _N (ft)	Y _C (ft)	F	C _d
1	20.58	1150.38	1.240	6.20	176.66	6.51	.735	6.94	3.16	5.08	.67	.801
2	14.34	801.45	1.010	5.05	120.54	6.65	.767	5.82	2.69	4.32	.76	.866
3	9.29	519.42	.804	4.02	79.26	6.55	.745	4.76	2.22	3.55	.83	.924
4	4.29	240.07	.570	2.85	42.66	5.63	.549	3.40	1.55	2.48	.83	.993
5	1.63	90.95	.432	2.16	26.21	3.47	.209	2.37	.97	1.54	.58	.928
6	.71	39.48	.337	1.69	17.10	2.31	.092	1.78	.63	.99	.44	.826
7	.56	31.40	.314	1.57	15.17	2.07	.074	1.64	.56	.88	.40	.798
8	.29	16.42	.263	1.32	11.25	1.46	.037	1.35	.39	.61	.31	.681
9	.13	7.06	.195	.97	6.85	1.03	.018	.99	.24	.37	.25	.633
10	.06	3.26	.149	.74	4.39	.74	.010	.75	.15	.23	.21	.581

TABLE A-40

W2/0.50/T(4:1)-0.500/5:1

No.	Q _M (cfs)	Q _P (cfs)	H _M (ft)	H _P (ft)	A _P (ft ²)	V _P (ft/sec)	H _V (ft)	H _T (ft)	Y _N (ft)	Y _C (ft)	F	C _d
1	8.70	486.19	1.095	5.48	170.05	2.86	.142	5.62	2.75	3.44	.30	.573
2	5.30	296.15	.907	4.54	124.33	2.38	.098	4.63	2.21	2.73	.27	.565
3	3.19	178.16	.746	3.73	90.79	1.96	.067	3.80	1.75	2.14	.24	.559
4	1.50	83.89	.567	2.84	59.59	1.41	.034	2.87	1.22	1.47	.19	.530
5	.92	51.38	.472	2.36	45.63	1.13	.022	2.38	.96	1.14	.16	.517
6	.53	29.52	.377	1.89	33.48	.88	.013	1.90	.72	.85	.14	.524
7	.16	8.72	.244	1.22	19.51	.45	.003	1.22	.37	.42	.08	.464
8	.30	16.62	.313	1.57	26.32	.63	.007	1.57	.53	.61	.11	.473
9	.10	5.79	.205	1.03	16.08	.36	.002	1.03	.30	.33	.07	.477
10	.05	2.56	.145	.72	11.40	.22	.001	.73	.18	.20	.05	.502

TABLE A-41

W2/0.50/T(4:1)-1.000/5:1

No.	Q _M (cfs)	Q _P (cfs)	H _M (ft)	H _P (ft)	A _P (ft ²)	V _P (ft/sec)	H _V (ft)	H _T (ft)	Y _N (ft)	Y _C (ft)	F	C _d
1	6.58	367.85	1.000	5.00	171.36	2.15	.080	5.08	2.43	3.02	.22	.558
2	4.10	229.40	.835	4.18	130.69	1.76	.053	4.23	1.96	2.42	.19	.550
3	2.37	132.44	.679	3.40	97.24	1.36	.032	3.43	1.52	1.85	.16	.537
4	.86	47.95	.473	2.37	60.53	.79	.011	2.38	.92	1.10	.11	.486
5	.24	13.59	.300	1.50	36.26	.37	.002	1.50	.47	.55	.06	.433
6	.10	5.72	.216	1.08	26.63	.21	.001	1.08	.29	.33	.04	.415
7	.04	2.39	.157	.79	20.72	.12	.000	.79	.18	.19	.02	.386

TABLE A-42

W5/0.00/T-0.00(5:1)/10:1

No.	Q _M (cfs)	Q _P (cfs)	H _M (ft)	H _P (ft)	A _P (ft ²)	V _P (ft/sec)	H _V (ft)	H _T (ft)	Y _N (ft)	Y _C (ft)	F	C _d
1	4.85	1533.67	.515	5.15	184.11	8.33	1.203	6.35	INF.	4.90	.90	.531
2	3.51	108.84	.463	4.63	153.48	7.22	.905	5.54	INF.	4.21	.81	.542
3	2.64	833.64	.419	4.19	129.68	6.43	.717	4.91	INF.	3.67	.76	.551
4	2.14	677.86	.397	3.97	118.50	5.72	.567	4.54	INF.	3.32	.69	.545
5	1.56	493.13	.354	3.54	98.06	5.03	.439	3.98	INF.	2.84	.64	.551
6	.92	290.63	.300	3.00	75.00	3.88	.260	3.26	INF.	2.17	.53	.534
7	.43	136.65	.230	2.30	49.45	2.76	.132	2.43	INF.	1.46	.42	.522
8	.38	120.46	.223	2.23	47.16	2.55	.113	2.34	INF.	1.36	.39	.505
9	.16	50.62	.170	1.70	31.45	1.61	.045	1.74	INF.	.83	.28	.444

TABLE A-43

W5/0.50/T-0.00(5:1)/10:1

No.	Q _M (cfs)	Q _P (cfs)	H _M (ft)	H _P (ft)	A _P (ft ²)	V _P (ft/sec)	H _V (ft)	H _T (ft)	Y _N (ft)	Y _C (ft)	F	C _d
1	9.10	2878.53	.562	5.62	210.82	13.65	3.233	8.85	5.02	6.54	1.42	.435
2	5.20	1643.05	.491	4.91	166.70	9.86	1.685	6.59	3.92	5.06	1.09	.519
3	3.01	953.30	.404	4.04	119.50	7.98	1.104	5.14	3.06	3.92	.96	.560
4	2.14	676.55	.360	3.60	98.51	6.87	.818	4.42	2.61	3.32	.87	.581
5	1.77	561.13	.349	3.49	93.57	6.00	.624	4.11	2.39	3.03	.77	.576
6	1.35	426.69	.318	3.18	80.28	5.31	.490	3.67	2.09	2.64	.71	.583
7	.67	210.68	.252	2.52	55.20	3.82	.253	2.77	1.48	1.84	.56	.580
8	.37	115.93	.210	2.10	41.51	2.79	.135	2.24	1.08	1.33	.45	.547
9	.32	102.27	.202	2.02	39.10	2.62	.119	2.14	1.02	1.24	.43	.539
10	.23	74.10	.181	1.81	33.09	2.24	.087	1.90	.85	1.04	.38	.527
11	.10	31.10	.134	1.34	21.22	1.47	.037	1.38	.53	.62	.28	.493

TABLE A-44

W5/1.00/T-0.00(5:1)/10:1

No.	Q _M (cfs)	Q _P (cfs)	H _M (ft)	H _P (ft)	A _P (ft ²)	V _P (ft/sec)	H _V (ft)	H _T (ft)	Y _N (ft)	Y _C (ft)	F	C _d
1	9.31	2942.82	.495	4.95	166.11	17.72	5.443	10.39	4.35	6.61	1.97	.298
2	5.14	1626.70	.385	3.85	107.81	15.09	3.948	7.80	3.34	5.04	1.87	.338
3	2.88	910.27	.311	3.11	75.40	12.07	2.528	5.64	2.55	3.84	1.65	.425
4	1.65	523.13	.302	3.02	71.83	7.28	.920	3.94	1.95	2.93	1.01	.599
5	1.62	512.75	.300	3.00	71.05	7.22	.903	3.90	1.93	2.90	1.00	.601
6	.90	284.31	.201	2.01	37.34	7.61	1.005	3.02	1.44	2.15	1.26	.635
7	.83	260.97	.199	1.99	36.76	7.10	.874	2.86	1.38	2.06	1.18	.663
8	.58	182.74	.201	2.01	37.34	4.89	.415	2.43	1.15	1.71	.81	.703
9	.47	149.54	.187	1.87	33.36	4.48	.348	2.22	1.03	1.53	.76	.719
10	.29	90.90	.167	1.67	28.02	3.24	.182	1.85	.79	1.17	.58	.686
11	.16	50.36	.137	1.37	20.76	2.43	.102	1.47	.57	.83	.47	.675

TABLE A-45

W5/1.50/T-0.00(5:1)/10:1

No.	Q _M (cfs)	Q _P (cfs)	H _M (ft)	H _P (ft)	A _P (ft ²)	V _P (ft/sec)	H _V (ft)	H _T (ft)	Y _N (ft)	Y _C (ft)	F	C _d
1	9.48	2996.82	.466	4.66	146.80	20.41	7.228	11.89	4.01	6.68	2.35	.217
2	5.40	1706.88	.362	3.62	94.90	17.99	5.610	9.23	3.11	5.16	2.32	.233
3	2.83	895.47	.277	2.77	60.52	14.80	3.797	6.57	2.30	3.81	2.15	.286
4	2.20	694.74	.247	2.47	50.11	13.86	3.333	5.80	2.03	3.37	2.12	.302
5	1.67	528.25	.222	2.22	42.12	12.54	2.727	4.95	1.78	2.95	2.01	.342
6	.92	290.63	.189	1.89	32.54	8.93	1.384	3.27	1.31	2.18	1.54	.528
7	.97	305.85	.186	1.86	31.72	9.64	1.612	3.47	1.35	2.24	1.67	.480
8	.65	206.29	.187	1.87	31.99	6.45	.721	2.59	1.10	1.82	1.12	.673
9	.29	90.18	.151	1.51	22.85	3.95	.270	1.78	.71	1.16	.75	.752
10	.27	86.86	.144	1.44	21.22	4.09	.291	1.73	.69	1.14	.80	.777
11	.11	33.92	.111	1.11	14.21	2.39	.099	1.21	.41	.66	.53	.744
12	.10	31.10	.111	1.11	14.21	2.19	.083	1.19	.39	.63	.48	.705

TABLE A-46

W5/0.00/T(5:1)-0.500/10:1

No.	Q _M (cfs)	Q _P (cfs)	H _M (ft)	H _P (ft)	A _P (ft ²)	V _P (ft/sec)	H _V (ft)	H _T (ft)	Y _N (ft)	Y _C (ft)	F	C _d
1	8.91	2817.53	.668	6.68	329.56	8.55	1.268	7.95	INF.	6.47	.79	.558
2	5.04	1593.50	.554	5.54	242.81	6.56	.747	6.29	INF.	4.98	.66	.567
3	3.10	980.94	.463	4.63	182.88	5.36	.499	5.13	INF.	3.97	.58	.581
4	1.62	512.75	.373	3.73	131.76	3.89	.263	3.99	INF.	2.89	.46	.568
5	.87	274.56	.297	2.97	94.90	2.89	.145	3.12	INF.	2.11	.37	.565
6	.41	129.71	.226	2.26	65.69	1.97	.068	2.33	INF.	1.42	.28	.553
7	.28	87.08	.200	2.00	56.25	1.55	.042	2.04	INF.	1.13	.23	.516
8	.16	50.36	.167	1.67	45.24	1.11	.021	1.69	INF.	.83	.17	.477
9	.09	28.01	.131	1.31	34.48	.81	.011	1.32	INF.	.58	.14	.492

TABLE A-47

W5/0.50/T(5:1)-0.500/10:1

No.	Q _M (cfs)	Q _P (cfs)	H _M (ft)	H _P (ft)	A _P (ft ²)	V _P (ft/sec)	H _V (ft)	H _T (ft)	Y _N (ft)	Y _C (ft)	F	C _d
1	7.09	2241.66	.569	5.69	249.90	8.97	1.396	7.09	4.50	5.84	.90	.591
2	3.83	1212.47	.475	4.75	187.20	6.48	.728	5.48	3.42	4.39	.70	.609
3	2.69	849.52	.425	4.25	157.45	5.40	.505	4.75	2.90	3.71	.61	.608
4	1.67	526.55	.368	3.68	126.58	4.16	.300	3.98	2.32	2.94	.49	.587
5	1.04	328.70	.309	3.09	98.06	3.35	.195	3.28	1.84	2.32	.43	.593
6	.64	201.81	.272	2.72	81.94	2.46	.105	2.83	1.44	1.80	.33	.530
7	.38	121.44	.223	2.23	62.71	1.94	.065	2.30	1.11	1.37	.28	.537
8	.23	71.77	.186	1.86	49.78	1.44	.036	1.90	.84	1.02	.22	.511
9	.15	47.97	.160	1.60	41.51	1.16	.023	1.62	.67	.81	.18	.504

TABLE A-48

W5/1.00/T(5:1)-0.500/10:1

No.	Q _M (cfs)	Q _P (cfs)	H _M (ft)	H _P (ft)	A _P (ft ²)	V _P (ft/sec)	H _V (ft)	H _T (ft)	Y _N (ft)	Y _C (ft)	F	C _d
1	9.28	2933.72	.515	5.15	209.51	14.00	3.401	8.55	4.35	6.61	1.47	.484
2	5.14	1626.70	.460	4.60	175.00	9.30	1.499	6.10	3.34	5.04	1.02	.624
3	2.78	880.42	.327	3.27	104.04	8.46	1.242	4.51	2.51	3.78	1.06	.718
4	1.62	512.75	.277	2.77	81.94	6.26	.679	3.45	1.93	2.90	.84	.818
5	1.01	320.32	.259	2.59	74.60	4.29	.320	2.91	1.53	2.29	.59	.782
6	.61	192.52	.233	2.33	64.56	2.98	.154	2.48	1.18	1.76	.42	.698
7	.28	89.16	.186	1.86	48.14	1.85	.059	1.92	.78	1.15	.29	.616
8	.17	52.40	.157	1.57	39.10	1.34	.031	1.60	.58	.85	.22	.570
9	.09	27.06	.126	1.26	30.38	.89	.014	1.27	.40	.57	.16	.521

TABLE A-49

W5/1.50/T(5:1)-0.500/10:1

No.	Q _M (cfs)	Q _P (cfs)	H _M (ft)	H _P (ft)	A _P (ft ²)	V _P (ft/sec)	H _V (ft)	H _T (ft)	Y _N (ft)	Y _C (ft)	F	C _d
1	9.41	2974.44	.466	4.66	175.60	16.94	4.976	9.64	4.00	6.65	1.86	.364
2	6.80	2150.37	.402	4.02	139.18	15.45	4.140	8.16	3.45	5.74	1.80	.399
3	3.80	1201.40	.339	3.39	107.34	11.19	2.173	5.56	2.64	4.38	1.40	.580
4	1.58	500.36	.244	2.44	66.82	7.49	.972	3.41	1.73	2.87	1.06	.820
5	.87	274.56	.214	2.14	55.90	4.91	.418	2.56	1.28	2.12	.73	.925
6	.36	114.55	.164	1.64	39.70	2.89	.144	1.78	.80	1.33	.47	.950
7	.29	90.47	.161	1.61	38.81	2.33	.094	1.70	.71	1.16	.38	.841
8	.16	51.90	.137	1.37	31.99	1.62	.046	1.42	.52	.85	.28	.767

TABLE A-50

W5/0.00/C-0.00/10:1

No.	Q _M (cfs)	Q _P (cfs)	H _M (ft)	H _P (ft)	A _P (ft ²)	V _P (ft/sec)	H _V (ft)	H _T (ft)	Y _N (ft)	Y _C (ft)	F	C _d
1	8.56	2706.24	.633	6.33	259.51	10.43	1.886	8.22	INF.	6.91	1.03	.493
2	4.54	1434.62	.577	5.77	220.26	6.51	.736	6.51	INF.	5.02	.67	.469
3	2.53	800.93	.418	4.18	125.92	6.36	.702	4.88	INF.	3.75	.76	.536
4	1.49	472.68	.351	3.51	93.74	5.04	.441	3.95	INF.	2.88	.65	.537
5	.91	287.49	.297	2.97	71.06	4.05	.284	3.25	INF.	2.24	.56	.531
6	.51	161.39	.236	2.36	48.96	3.30	.188	2.55	INF.	1.68	.51	.549
7	.27	85.72	.200	2.00	37.66	2.28	.090	2.09	INF.	1.22	.38	.479
8	.15	46.87	.161	1.61	26.89	1.74	.053	1.66	INF.	.90	.32	.464
9	.09	29.37	.134	1.34	20.31	1.45	.036	1.38	INF.	.72	.29	.466

TABLE A-51

W5/0.50/C-0.00/10:1

No.	Q _M (cfs)	Q _P (cfs)	H _M (ft)	H _P (ft)	A _P (ft ²)	V _P (ft/sec)	H _V (ft)	H _T (ft)	Y _N (ft)	Y _C (ft)	F	C _d
1	8.24	2605.60	.570	5.70	212.26	12.28	2.613	8.31	5.04	6.79	1.28	.461
2	4.88	1542.36	.476	4.76	154.56	9.98	1.727	6.49	3.94	5.21	1.13	.507
3	2.64	833.64	.396	3.96	112.41	7.42	.954	4.91	2.96	3.83	.91	.549
4	1.59	503.93	.338	3.38	85.86	5.87	.597	3.98	2.34	2.97	.77	.563
5	.85	267.85	.272	2.72	59.73	4.48	.349	3.07	1.75	2.17	.65	.572
6	.65	206.29	.246	2.46	50.63	4.07	.288	2.75	1.55	1.90	.62	.581
7	.27	85.56	.189	1.89	33.06	2.59	.116	2.01	1.03	1.22	.44	.529
8	.15	47.97	.152	1.52	23.39	2.05	.073	1.59	.79	.92	.39	.528

TABLE A-52

W5/1.00/C-0.00/10:1

No.	Q _M (cfs)	Q _P (cfs)	H _M (ft)	H _P (ft)	A _P (ft ²)	V _P (ft/sec)	H _V (ft)	H _T (ft)	Y _N (ft)	Y _C (ft)	F	C _d
1	8.95	2831.73	.498	4.98	164.34	17.23	5.149	10.13	4.46	7.09	1.92	.306
2	4.93	1559.59	.395	3.95	109.51	14.24	3.518	7.47	3.37	5.25	1.77	.361
3	2.69	849.52	.340	3.40	84.57	10.04	1.750	5.15	2.54	3.87	1.33	.498
4	1.48	468.86	.276	2.76	59.37	7.90	1.082	3.84	1.93	2.87	1.15	.571
5	.83	260.97	.221	2.21	40.98	6.37	.703	2.91	1.47	2.14	1.03	.635
6	.51	161.39	.191	1.91	32.22	5.01	.435	2.35	1.18	1.68	.87	.676
7	.28	87.68	.149	1.49	21.48	4.08	.289	1.78	.89	1.24	.80	.732
8	.15	48.78	.126	1.26	16.34	2.99	.155	1.41	.68	.92	.64	.723

TABLE A-53

W5/1.50/C-0.00/10:1

No.	Q _M (cfs)	Q _P (cfs)	H _M (ft)	H _P (ft)	A _P (ft ²)	V _P (ft/sec)	H _V (ft)	H _T (ft)	Y _N (ft)	Y _C (ft)	F	C _d
1	9.10	2878.53	.446	4.46	132.68	21.69	8.163	12.62	4.08	7.16	2.57	.179
2	5.32	1683.23	.343	3.43	83.72	20.10	7.010	10.44	3.18	5.46	2.68	.169
3	2.97	939.18	.270	2.70	55.45	16.94	4.976	7.68	2.42	4.07	2.53	.203
4	1.59	502.15	.215	2.15	37.66	13.33	3.083	5.23	1.81	2.98	2.22	.283
5	.94	296.81	.179	1.79	27.66	10.73	1.997	3.79	1.42	2.29	1.95	.375
6	.43	136.65	.149	1.49	20.31	6.73	.785	2.27	.99	1.55	1.34	.617
7	.29	92.18	.162	1.62	23.39	3.94	.269	1.89	.83	1.27	.75	.662
8	.16	50.36	.127	1.27	15.50	3.25	.183	1.45	.62	.94	.71	.698

TABLE A-54

W5/0.00/C-0.00/2.5:1

No.	Q _M (cfs)	Q _P (cfs)	H _M (ft)	H _P (ft)	A _P (ft ²)	V _P (ft/sec)	H _V (ft)	H _T (ft)	Y _N (ft)	Y _C (ft)	F	C _d
1	8.35	82.54	.686	1.72	18.72	4.41	.337	2.05	INF.	1.71	.84	.482
2	4.04	39.90	.536	1.34	12.09	3.30	.189	1.53	INF.	1.18	.70	.487
3	1.91	18.88	.421	1.05	7.97	2.37	.097	1.15	INF.	.81	.56	.469
4	.87	8.58	.319	.80	5.00	1.72	.051	.85	INF.	.55	.46	.456
5	.36	3.58	.237	.59	3.08	1.16	.023	.62	INF.	.35	.36	.424
6	.22	2.21	.200	.50	2.35	.94	.015	.52	INF.	.28	.31	.409
7	.11	1.06	.157	.39	1.62	.66	.007	.40	INF.	.19	.24	.369

TABLE A-55

W5/0.50/C-0.00/2.5:1

No.	Q _M (cfs)	Q _P (cfs)	H _M (ft)	H _P (ft)	A _P (ft ²)	V _P (ft/sec)	H _V (ft)	H _T (ft)	Y _N (ft)	Y _C (ft)	F	C _d
1	9.04	89.37	.643	1.61	15.77	5.67	.557	2.16	1.47	1.78	1.13	.457
2	4.62	45.70	.529	1.32	11.05	4.13	.297	1.62	1.07	1.27	.90	.483
3	2.11	20.89	.394	.98	6.52	3.21	.178	1.16	.74	.86	.80	.505
4	.88	8.68	.293	.73	3.87	2.24	.087	.82	.49	.55	.65	.503
5	.31	3.03	.207	.52	2.12	1.43	.035	.55	.30	.33	.49	.470
6	.23	2.23	.189	.47	1.81	1.23	.026	.50	.26	.28	.44	.447
7	.12	1.20	.151	.38	1.23	.97	.016	.39	.20	.20	.39	.433

TABLE A-56

W5/1.00/C-0.00/2.5:1

No.	Q _M (cfs)	Q _P (cfs)	H _M (ft)	H _P (ft)	A _P (ft ²)	V _P (ft/sec)	H _V (ft)	H _T (ft)	Y _N (ft)	Y _C (ft)	F	C _d
1	18.46	182.41	.765	1.91	20.67	8.82	1.350	3.26	1.74	2.55	1.65	.335
2	8.97	88.64	.570	1.43	11.86	7.47	.969	2.39	1.24	1.77	1.61	.352
3	4.57	45.12	.432	1.08	7.06	6.39	.709	1.79	.91	1.26	1.57	.372
4	1.95	19.24	.316	.79	3.94	4.88	.414	1.20	.61	.82	1.40	.427
5	.95	9.37	.249	.62	2.52	3.71	.239	.86	.44	.57	1.21	.479
6	.49	4.86	.204	.51	1.73	2.81	.137	.65	.32	.41	1.02	.509
7	.24	2.35	.168	.42	1.18	1.99	.069	.49	.23	.29	.81	.498
8	.23	2.28	.168	.42	1.18	1.92	.064	.48	.23	.28	.78	.492
9	.10	1.04	.143	.36	.85	1.21	.025	.38	.16	.19	.55	.402
10	.06	.55	.127	.32	.66	.83	.012	.33	.12	.14	.41	.313

TABLE A-57

W5/1.50/C-0.00/2.5:1

No.	Q _M (cfs)	Q _P (cfs)	H _M (ft)	H _P (ft)	A _P (ft ²)	V _P (ft/sec)	H _V (ft)	H _T (ft)	Y _N (ft)	Y _C (ft)	F	C _d
1	20.38	201.36	.772	1.93	20.01	10.06	1.756	3.69	1.66	2.69	1.90	.272
2	10.55	104.25	.601	1.50	12.29	8.48	1.247	2.75	1.22	1.93	1.81	.293
3	5.17	51.09	.449	1.12	6.96	7.34	.933	2.06	.87	1.35	1.82	.297
4	1.89	18.65	.313	.78	3.42	5.45	.515	1.30	.55	.81	1.63	.343
5	1.61	15.91	.245	.61	2.08	7.64	1.012	1.62	.51	.75	2.63	.167
6	.17	1.68	.167	.42	.90	1.86	.060	.48	.18	.24	.83	.377
7	.11	1.10	.154	.39	.75	1.47	.037	.42	.15	.20	.70	.333
8	.05	.51	.140	.35	.59	.86	.013	.36	.10	.13	.44	.225

TABLE A-58

W5/0.00/C-0.500/2.5:1

No.	Q _M (cfs)	Q _P (cfs)	H _M (ft)	H _P (ft)	A _P (ft ²)	V _P (ft/sec)	H _V (ft)	H _T (ft)	Y _N (ft)	Y _C (ft)	F	C _d
1	8.03	79.31	.740	1.85	33.15	2.39	.099	1.95	INF.	1.67	.39	.527
2	4.96	49.00	.626	1.57	26.18	1.87	.061	1.63	INF.	1.31	.33	.513
3	2.64	26.05	.499	1.25	19.36	1.35	.031	1.28	INF.	.96	.25	.497
4	1.44	14.23	.406	1.02	15.01	.95	.016	1.03	INF.	.71	.19	.465
5	.88	8.68	.339	.85	12.21	.71	.009	.86	INF.	.55	.15	.451
6	.47	4.67	.266	.67	9.48	.49	.004	.67	INF.	.40	.11	.450
7	.27	2.66	.225	.56	8.10	.33	.002	.56	INF.	.30	.08	.393
8	.15	1.52	.185	.46	6.84	.22	.001	.46	INF.	.23	.05	.366
9	.09	.88	.148	.37	5.78	.15	.000	.37	INF.	.17	.04	.370
10	.05	.51	.127	.32	5.21	.10	.000	.32	INF.	.13	.03	.313

TABLE A-59

W5/0.50/C-0.500/2.5:1

No.	Q _M (cfs)	Q _P (cfs)	H _M (ft)	H _P (ft)	A _P (ft ²)	V _P (ft/sec)	H _V (ft)	H _T (ft)	Y _N (ft)	Y _C (ft)	F	C _d
1	9.03	89.23	.758	1.90	33.02	2.70	.127	2.02	1.47	1.78	.45	.541
2	4.39	43.35	.592	1.48	23.16	1.87	.061	1.54	1.05	1.24	.34	.519
3	2.21	21.83	.473	1.18	17.14	1.27	.028	1.21	.76	.88	.26	.477
4	.98	9.65	.351	.88	11.90	.81	.011	.89	.52	.58	.17	.457
5	.39	3.82	.249	.62	8.23	.46	.004	.63	.34	.37	.11	.434
6	.23	2.24	.209	.52	6.96	.32	.002	.52	.26	.28	.08	.396
7	.10	1.02	.158	.40	5.50	.19	.001	.40	.18	.19	.05	.367
8	.05	.53	.126	.32	4.67	.11	.000	.32	.14	.14	.03	.335

TABLE A-60

W5/1.00/C-0.500/2.5:1

No.	Q _M (cfs)	Q _P (cfs)	H _M (ft)	H _P (ft)	A _P (ft ²)	V _P (ft/sec)	H _V (ft)	H _T (ft)	Y _N (ft)	Y _C (ft)	F	C _d
1	5.57	55.03	.577	1.44	21.29	2.58	.116	1.56	.99	1.40	.48	.640
2	2.78	27.51	.488	1.22	16.91	1.63	.046	1.27	.72	.98	.32	.538
3	1.58	15.64	.414	1.04	13.64	1.15	.023	1.06	.55	.74	.24	.479
4	.90	8.88	.339	.85	10.68	.83	.012	.86	.43	.56	.18	.457
5	.39	3.82	.255	.64	7.77	.49	.004	.64	.29	.37	.12	.409
6	.26	2.54	.219	.55	6.67	.38	.003	.55	.24	.30	.10	.399
7	.14	1.38	.177	.44	5.47	.25	.001	.44	.18	.22	.07	.372

TABLE A-61

W5/1.50/C-0.500/2.5:1

No.	Q_M (cfs)	Q_P (cfs)	H_M (ft)	H_P (ft)	A_P (ft ²)	V_P (ft/sec)	H_V (ft)	H_T (ft)	Y_N (ft)	Y_C (ft)	F	C_d
1	8.89	87.90	.527	1.32	17.80	4.94	.423	1.74	1.13	1.77	.96	.776
2	5.01	49.53	.433	1.08	13.60	3.64	.230	1.31	.86	1.32	.76	.885
3	2.92	28.90	.391	.98	11.90	2.43	.102	1.08	.67	1.01	.52	.841
4	1.35	13.33	.353	.88	10.45	1.28	.028	.91	.47	.69	.28	.594
5	.56	5.55	.269	.67	7.58	.73	.009	.68	.31	.44	.18	.510
6	.36	3.51	.241	.60	6.72	.52	.005	.61	.25	.35	.13	.431
7	.18	1.76	.188	.47	5.23	.34	.002	.47	.18	.25	.09	.405
8	.10	.95	.153	.38	4.34	.22	.001	.38	.14	.18	.06	.366
9	.05	.53	.127	.32	3.73	.14	.000	.32	.11	.14	.04	.328

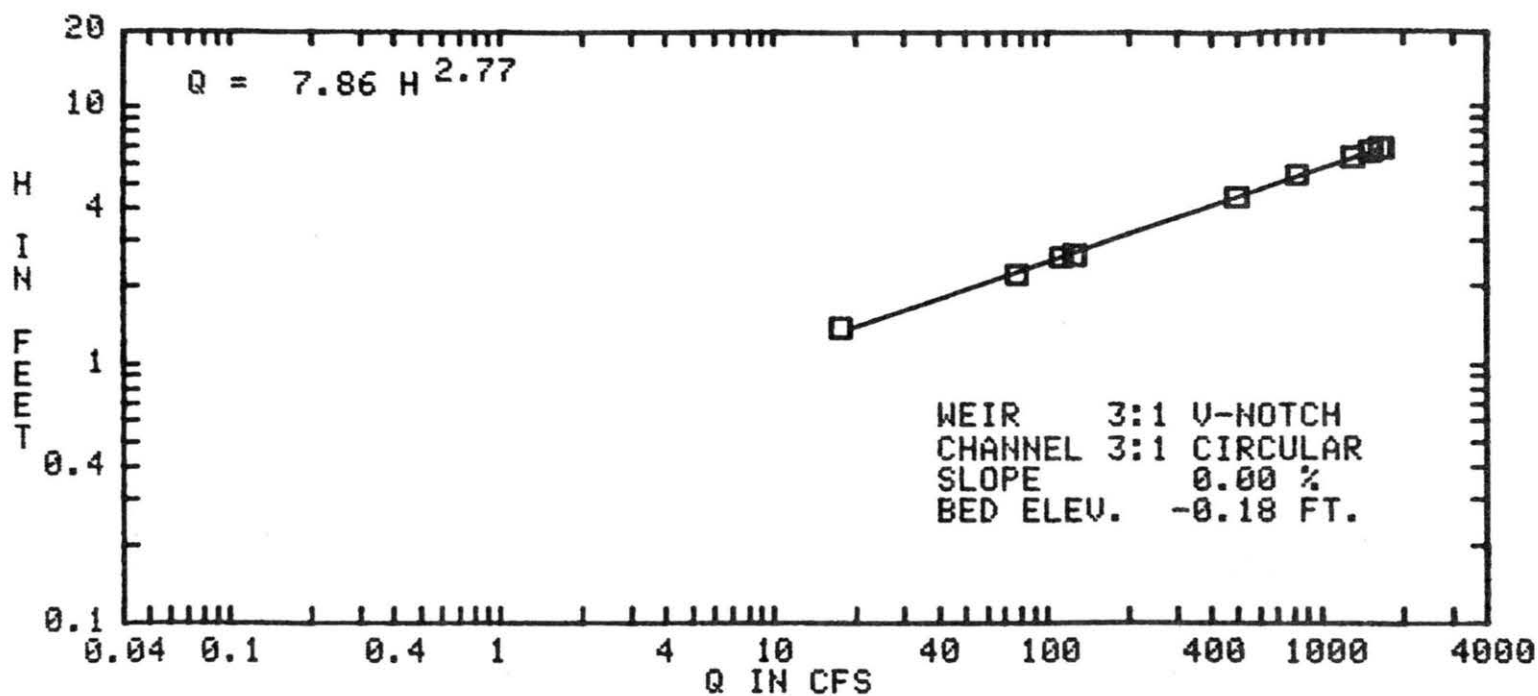

FIG. A-1 PLOT OF HEAD versus DISCHARGE DATA POINTS

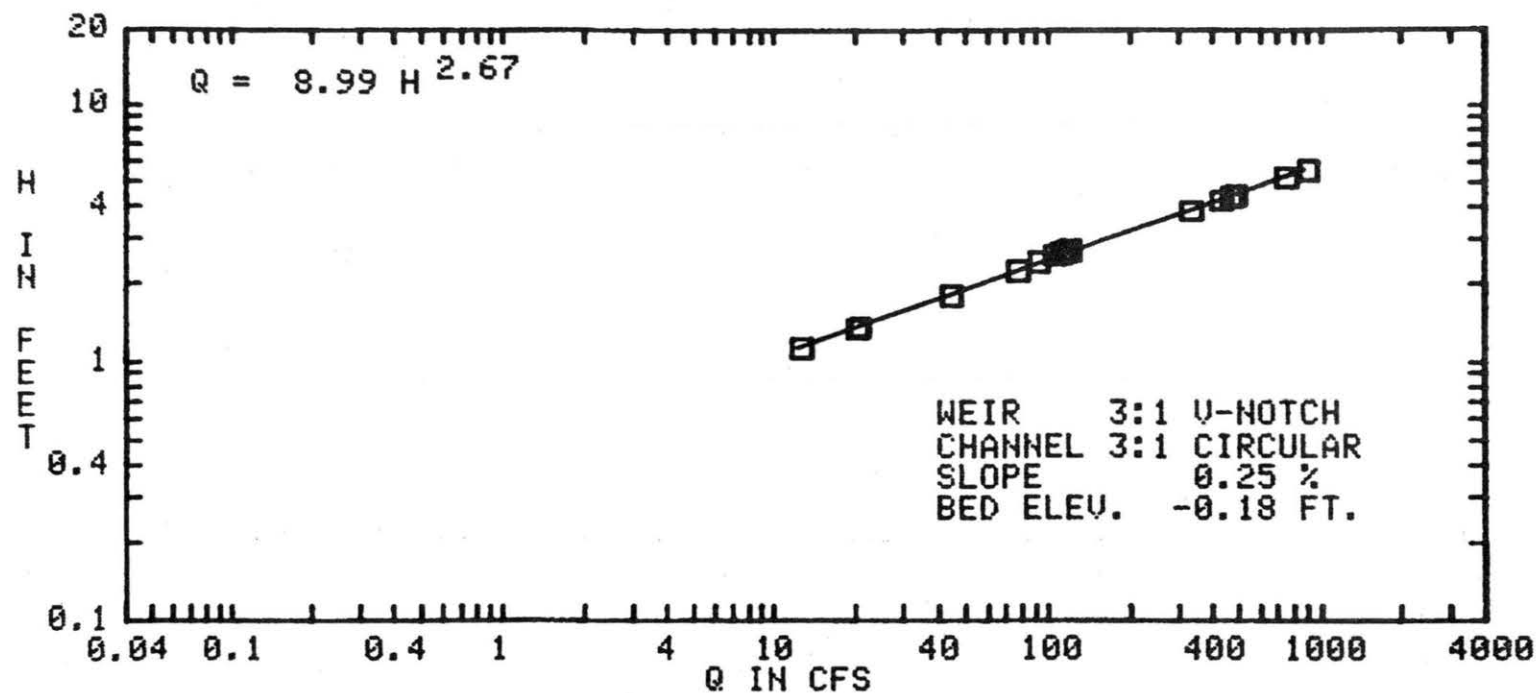

FIG. A-2 PLOT OF HEAD versus DISCHARGE DATA POINTS

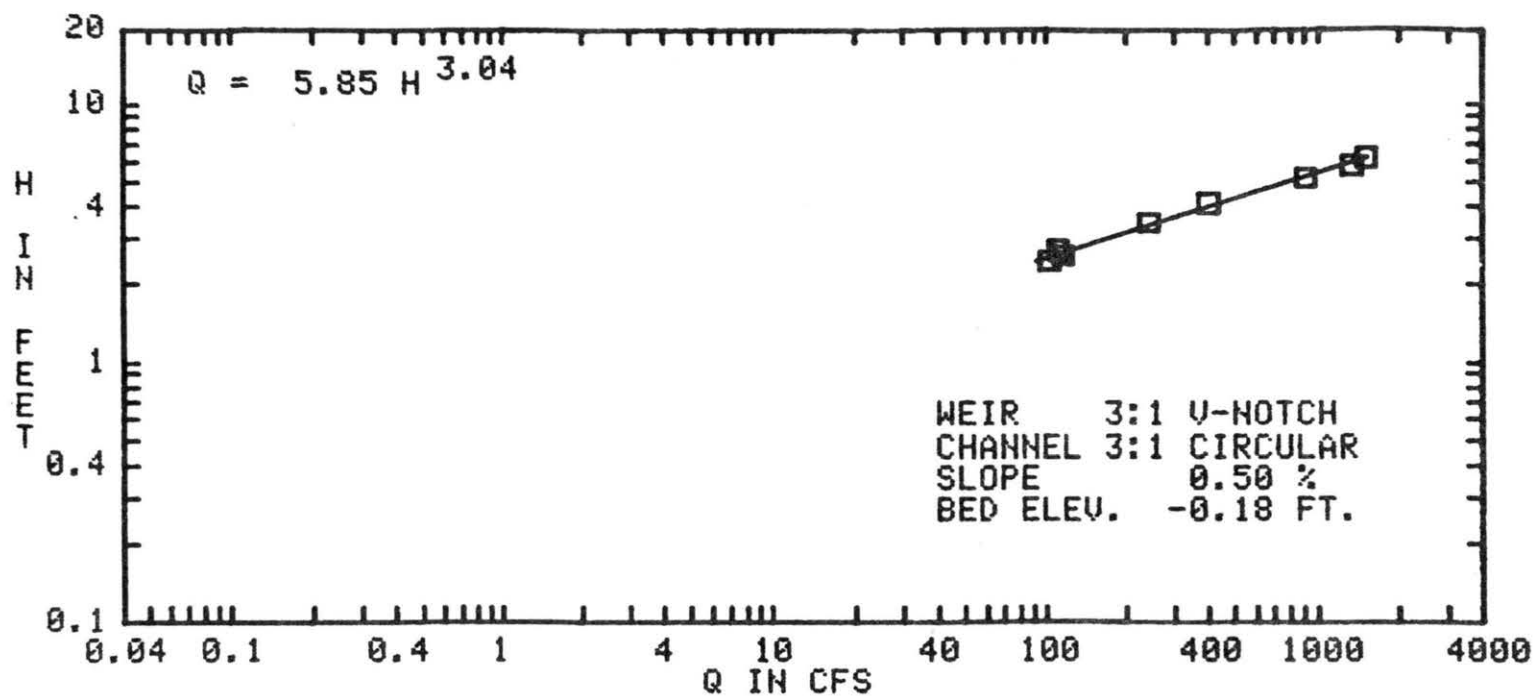

FIG. A-3 PLOT OF HEAD versus DISCHARGE DATA POINTS

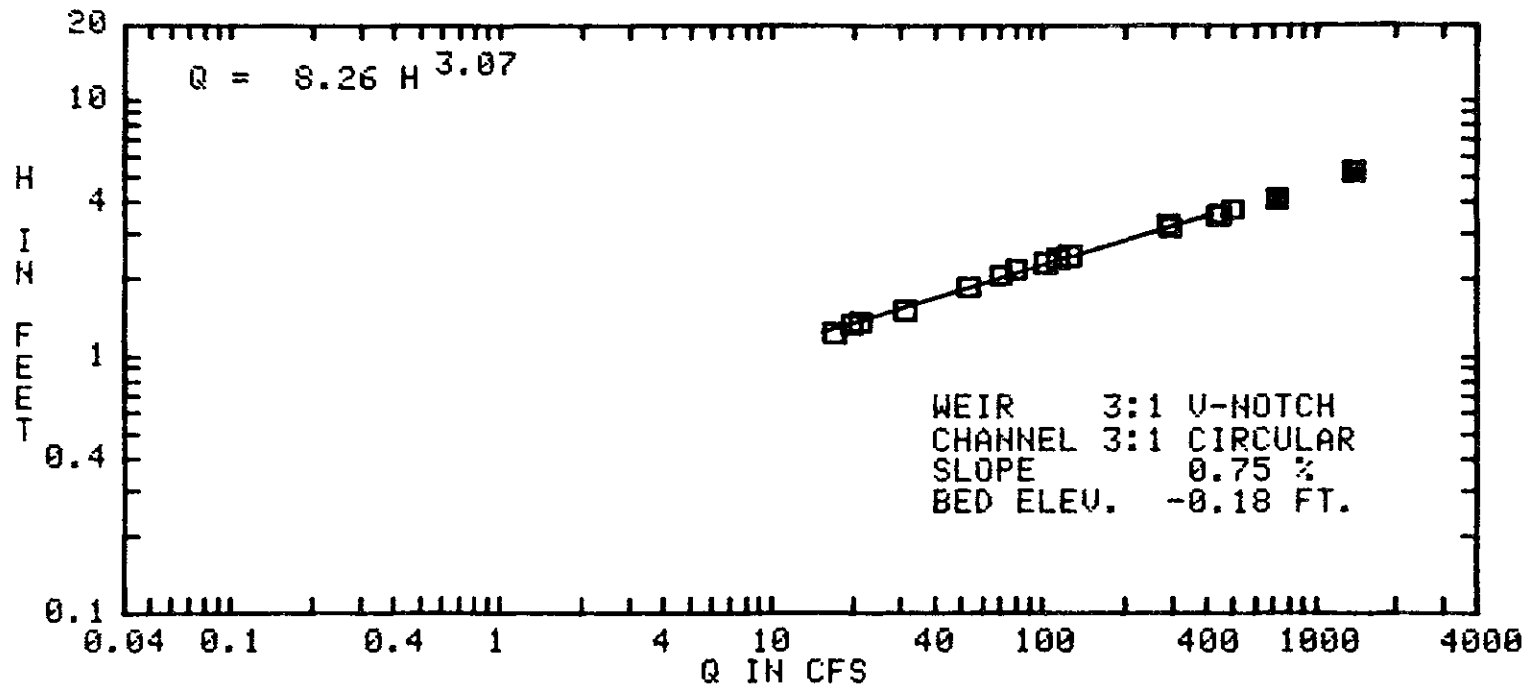

FIG. A-4 PLOT OF HEAD versus DISCHARGE DATA POINTS

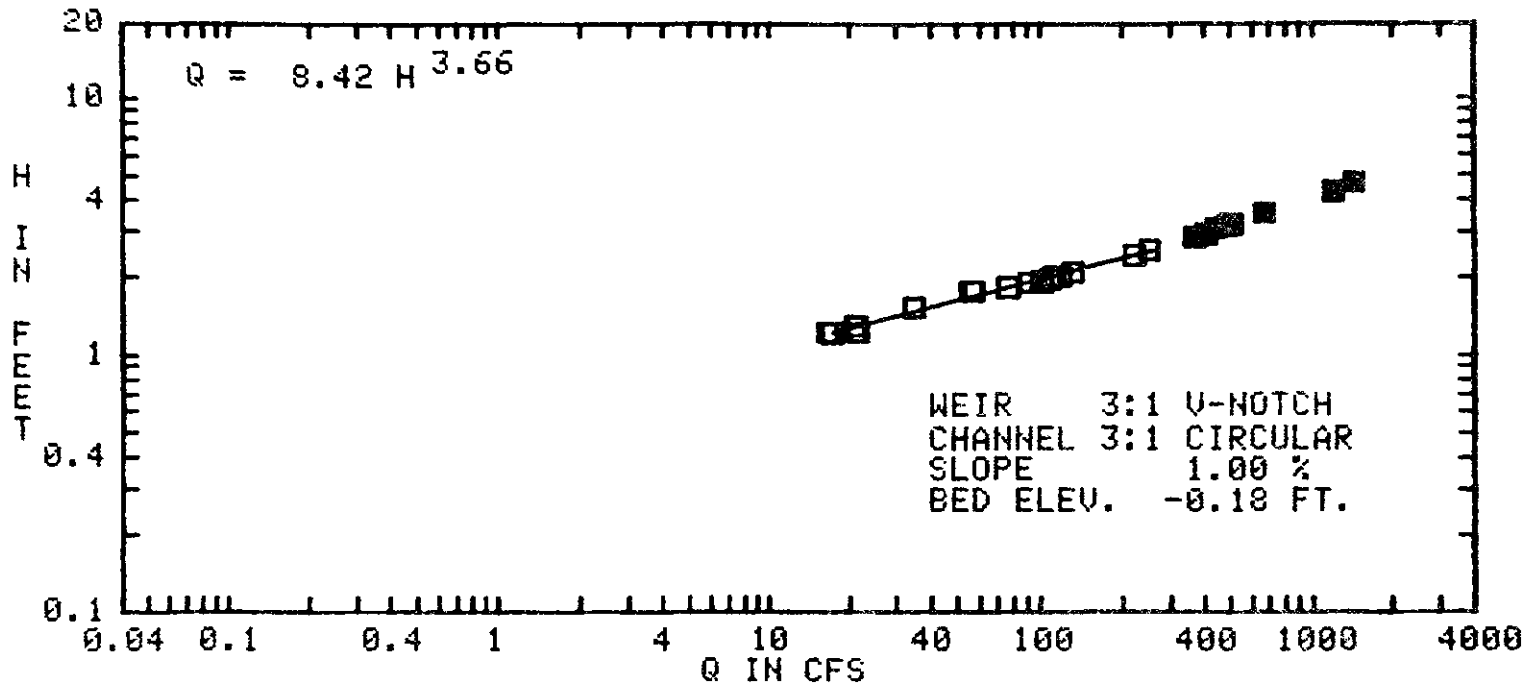

FIG. A-5 PLOT OF HEAD versus DISCHARGE DATA POINTS

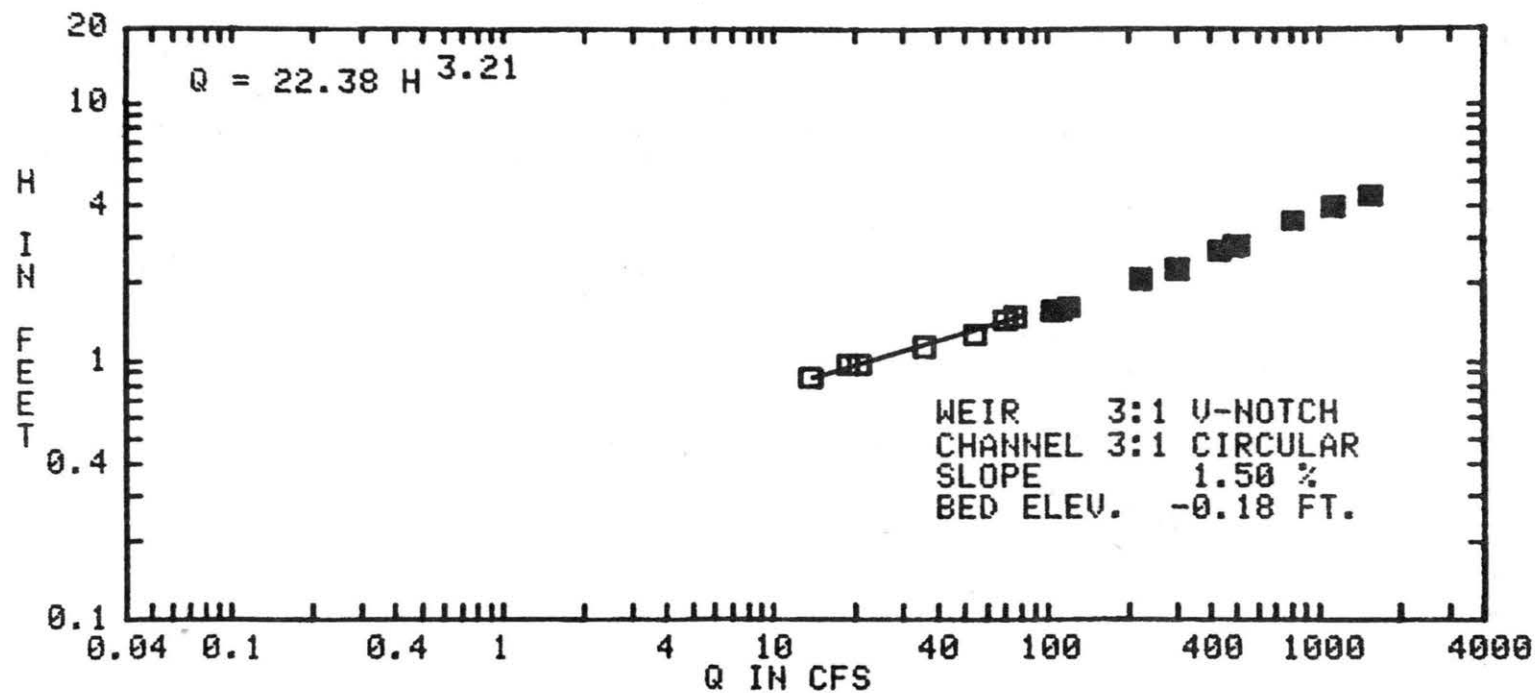

FIG. A-6 PLOT OF HEAD versus DISCHARGE DATA POINTS

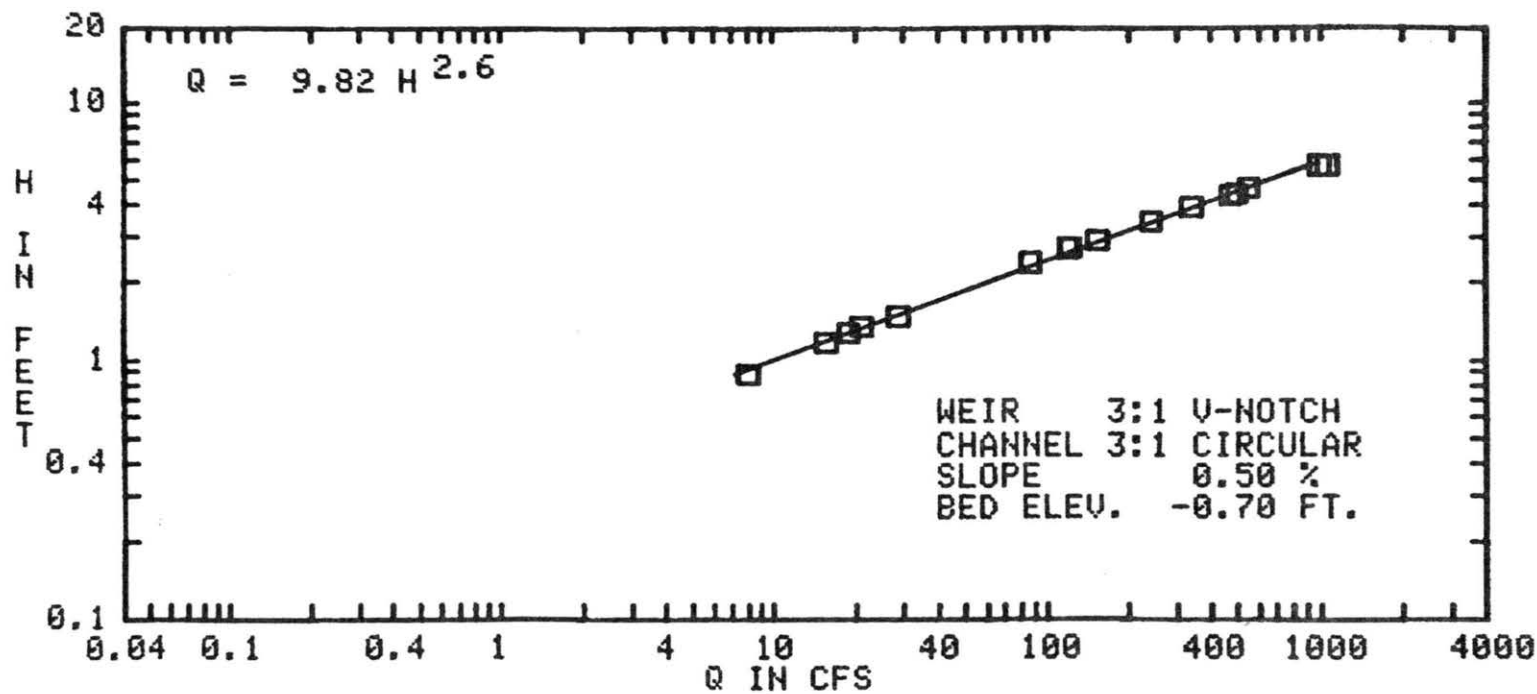

FIG. A-7 PLOT OF HEAD versus DISCHARGE DATA POINTS

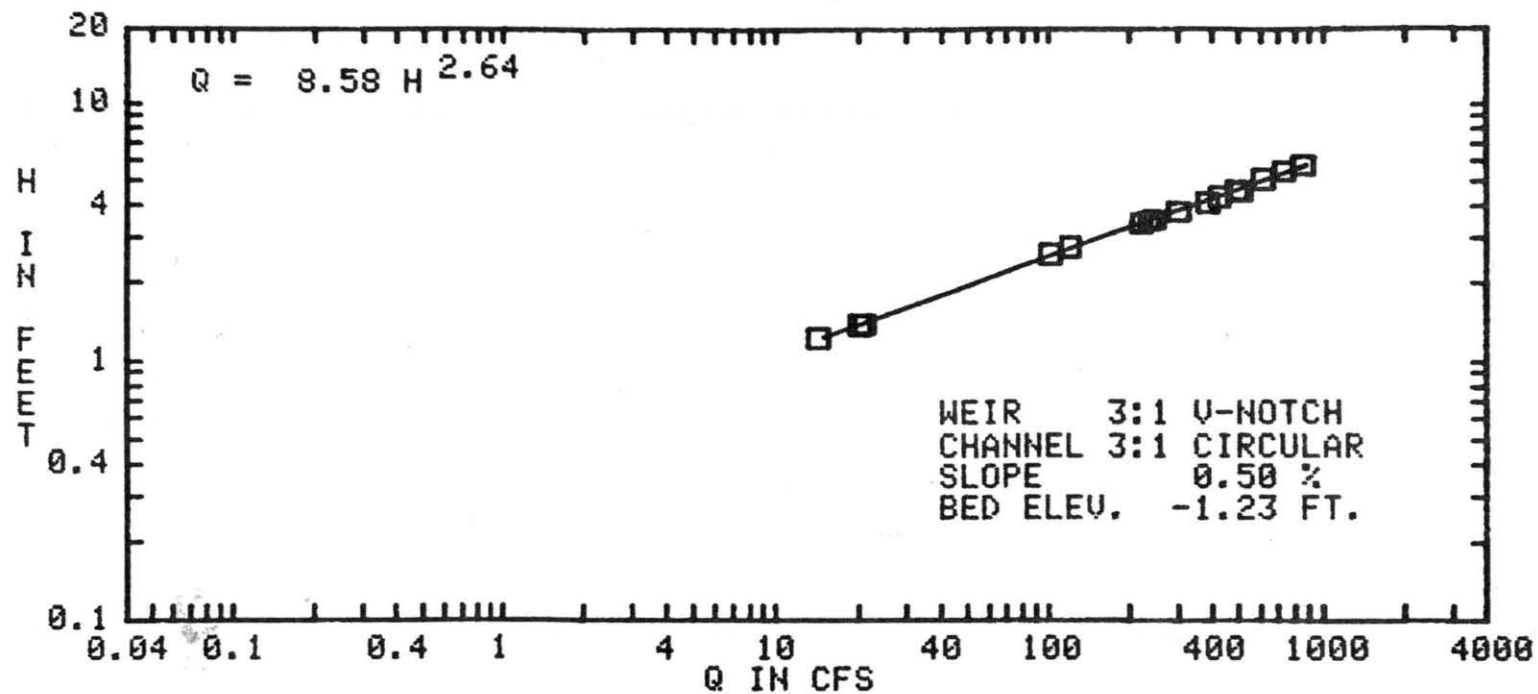

FIG. A-8 PLOT OF HEAD versus DISCHARGE DATA POINTS

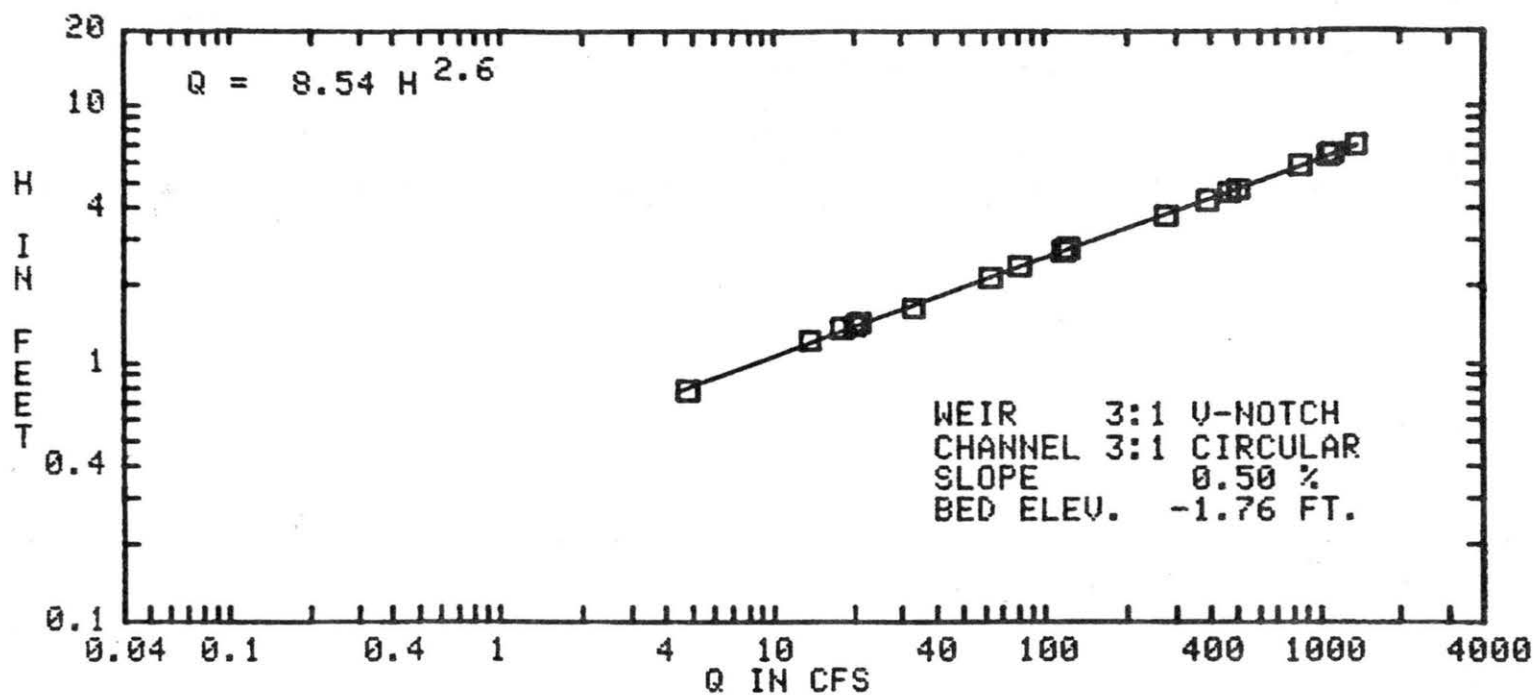

FIG. A-9 PLOT OF HEAD versus DISCHARGE DATA POINTS

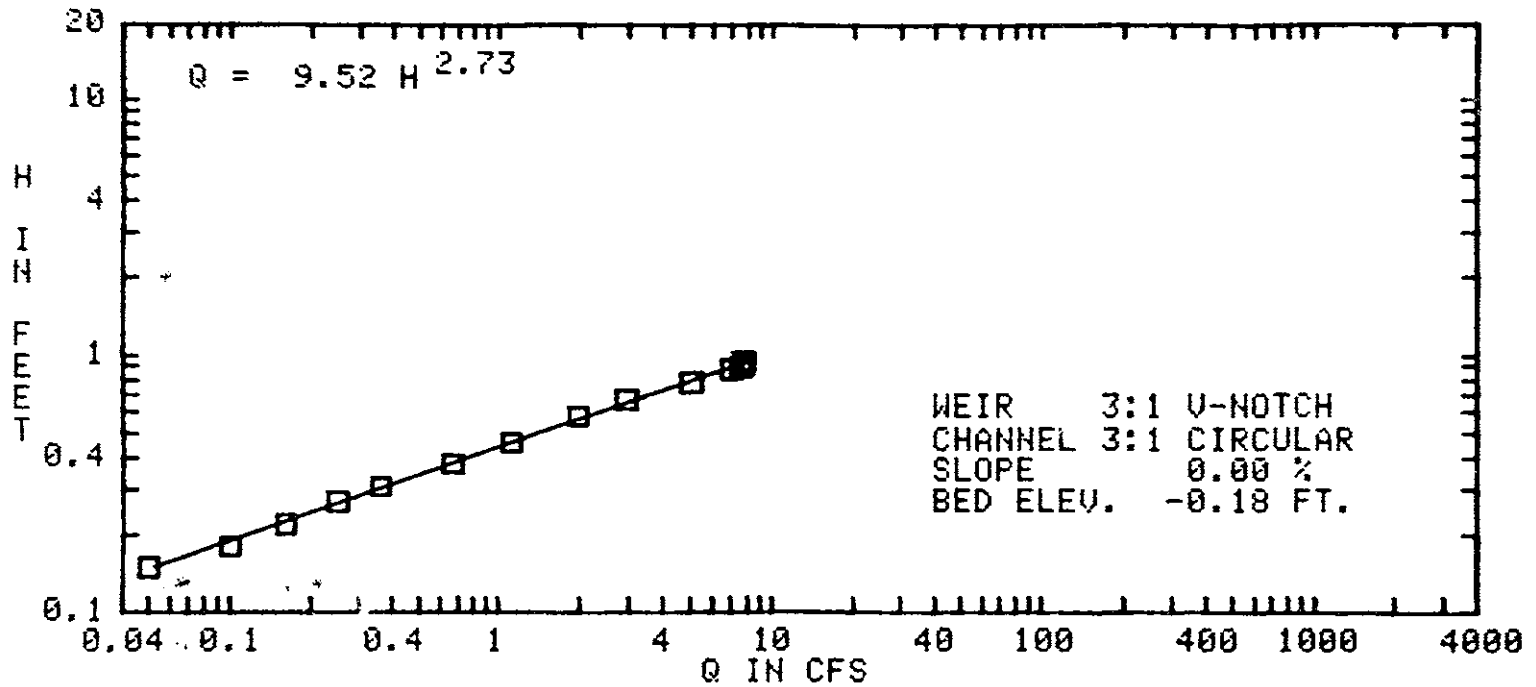

FIG. A-10 PLOT OF HEAD versus DISCHARGE DATA POINTS

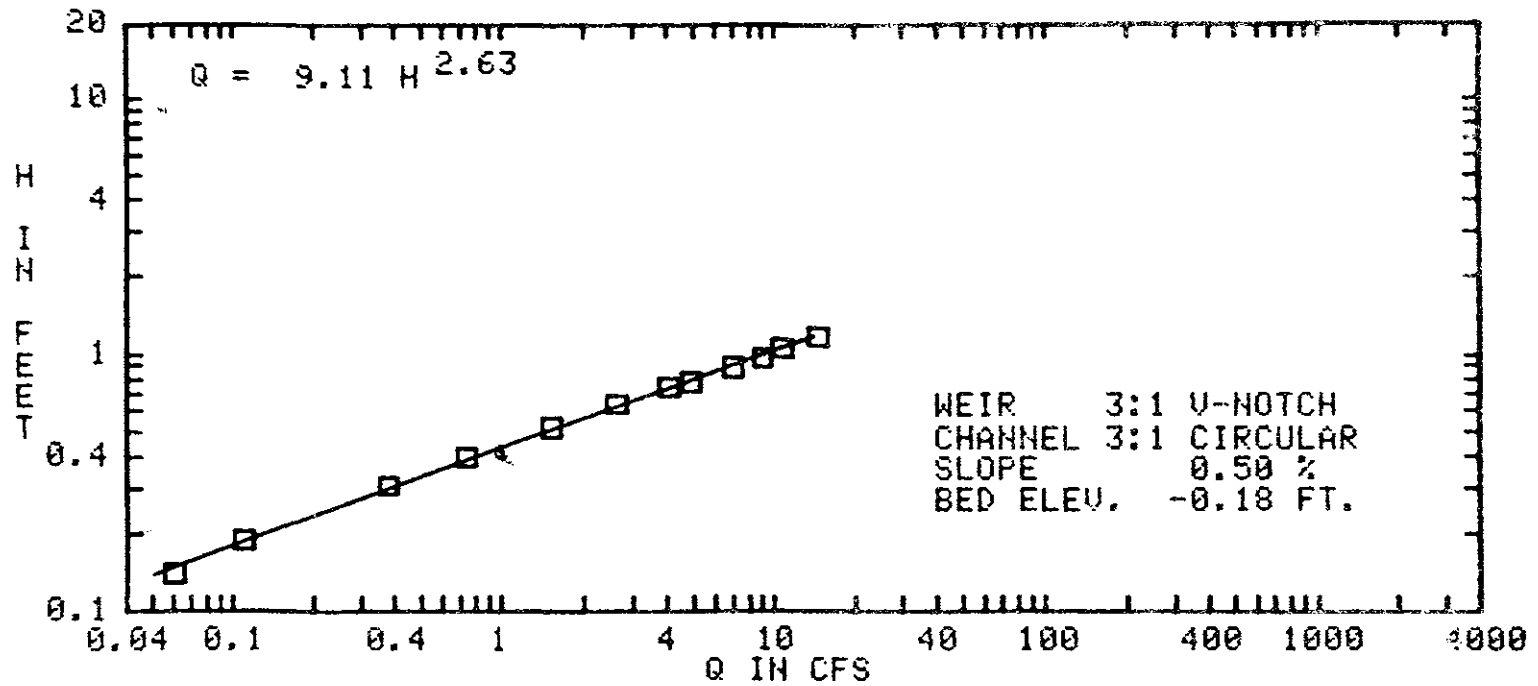

FIG. A-11 PLOT OF HEAD versus DISCHARGE DATA POINTS

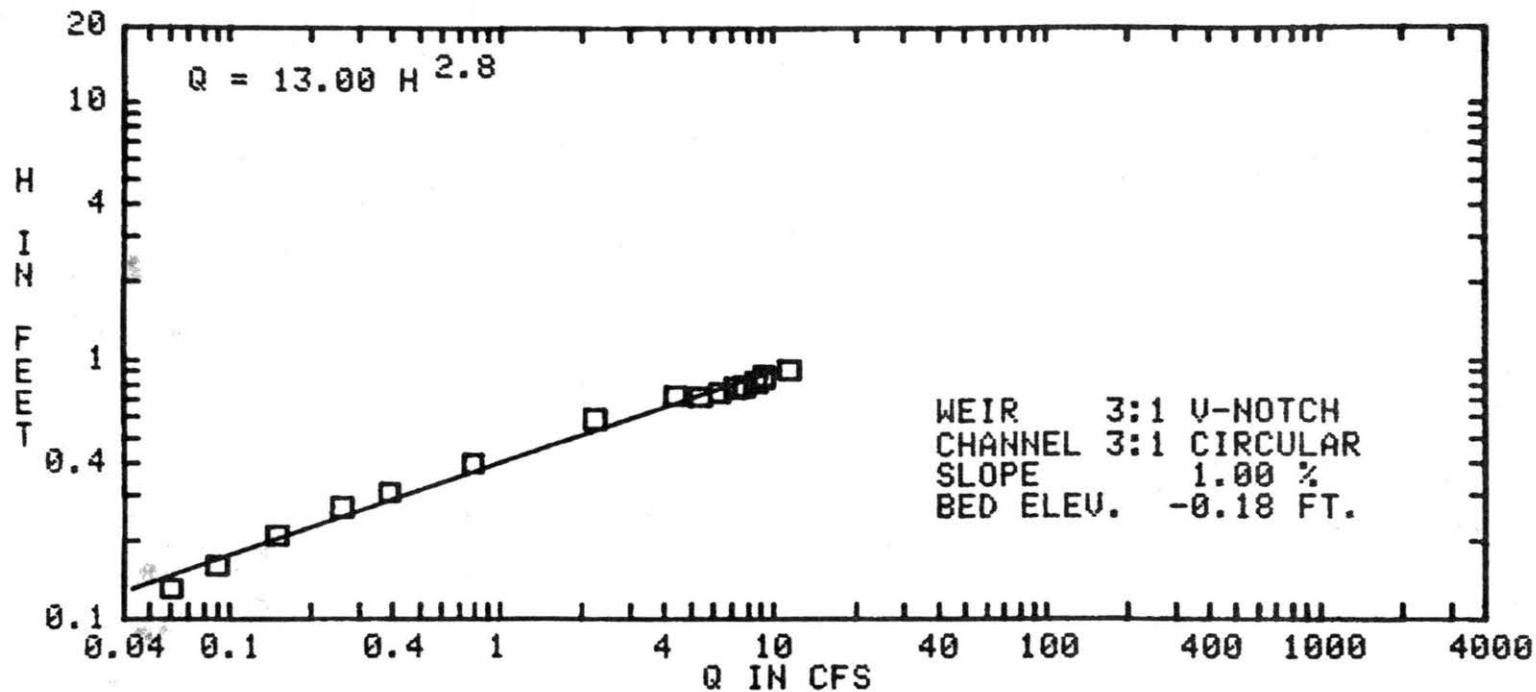

FIG. A-12 PLOT OF HEAD versus DISCHARGE DATA POINTS

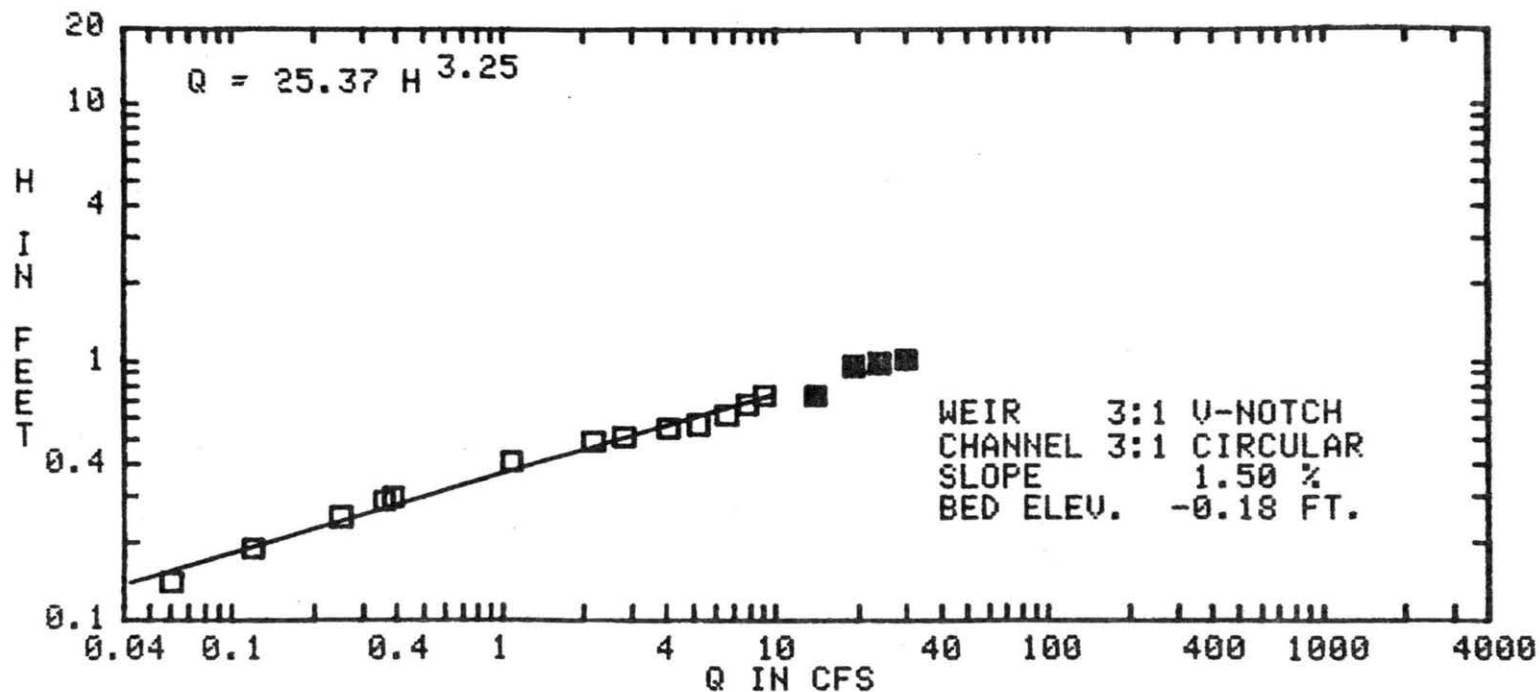

FIG. A-13 PLOT OF HEAD versus DISCHARGE DATA POINTS

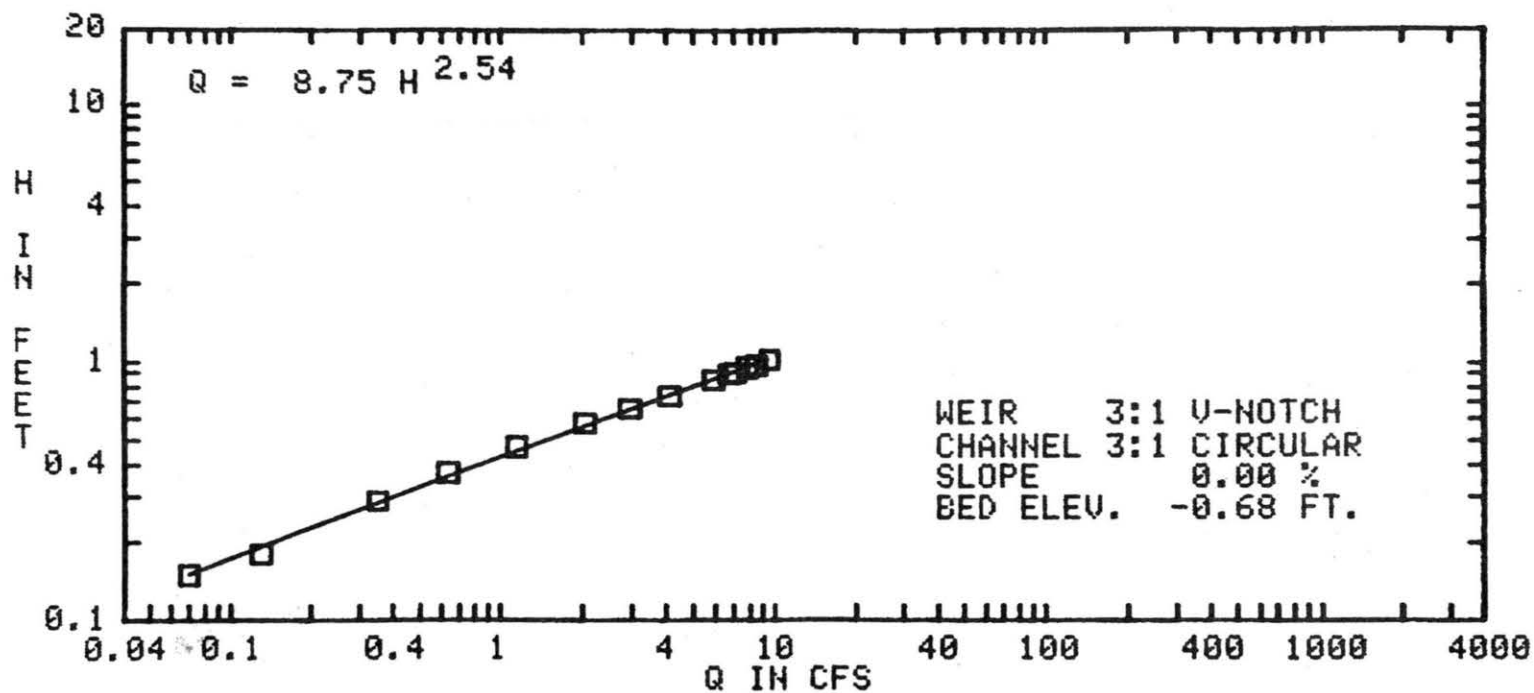

FIG. A-14 PLOT OF HEAD versus DISCHARGE DATA POINTS

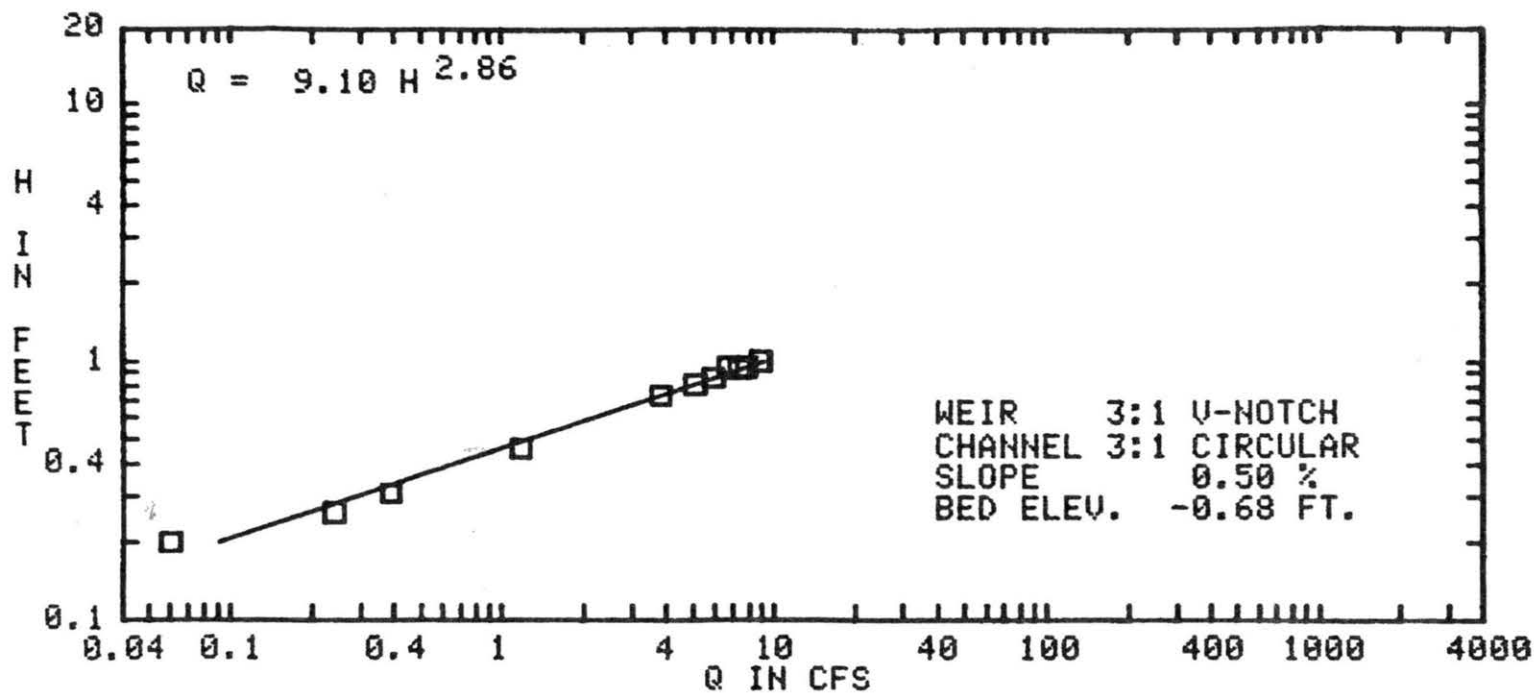

FIG. A-15 PLOT OF HEAD versus DISCHARGE DATA POINTS

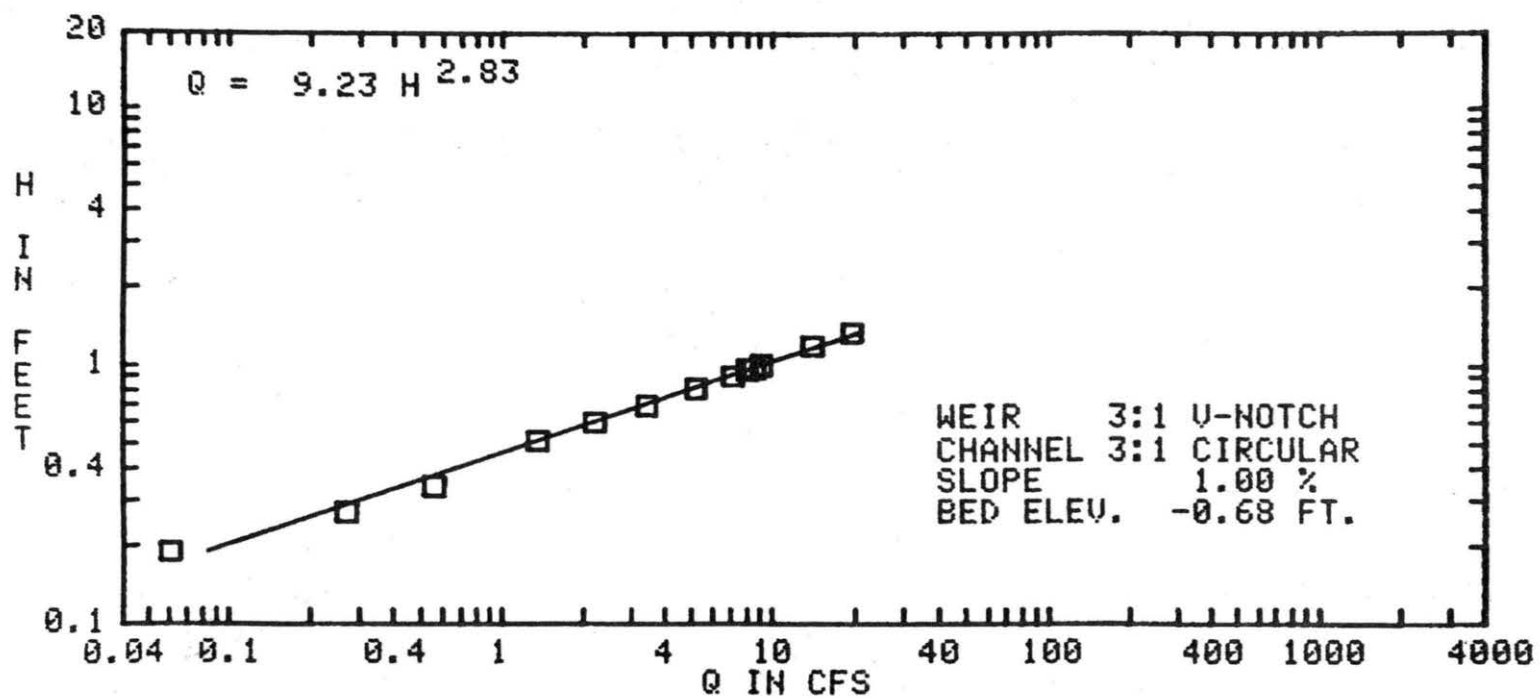

FIG. A-16 PLOT OF HEAD versus DISCHARGE DATA POINTS

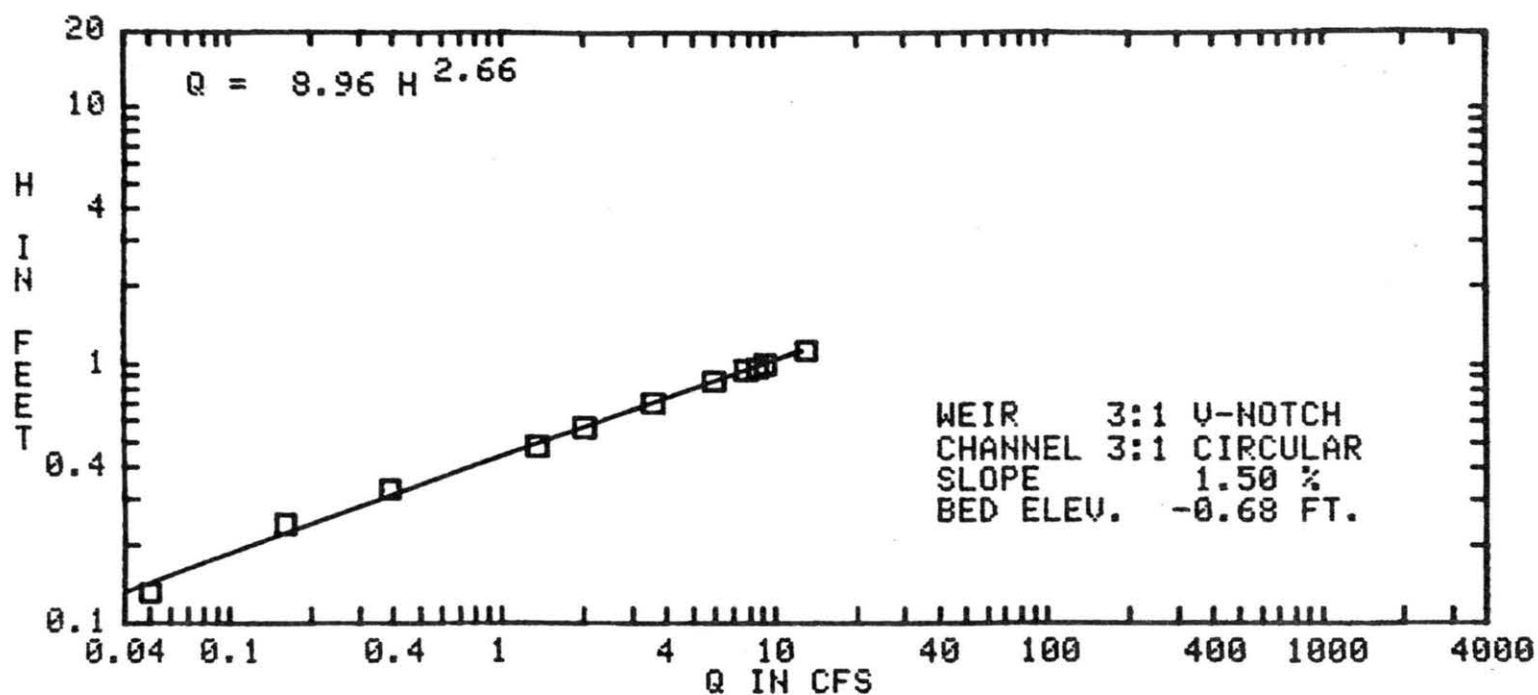

FIG. A-17 PLOT OF HEAD versus DISCHARGE DATA POINTS

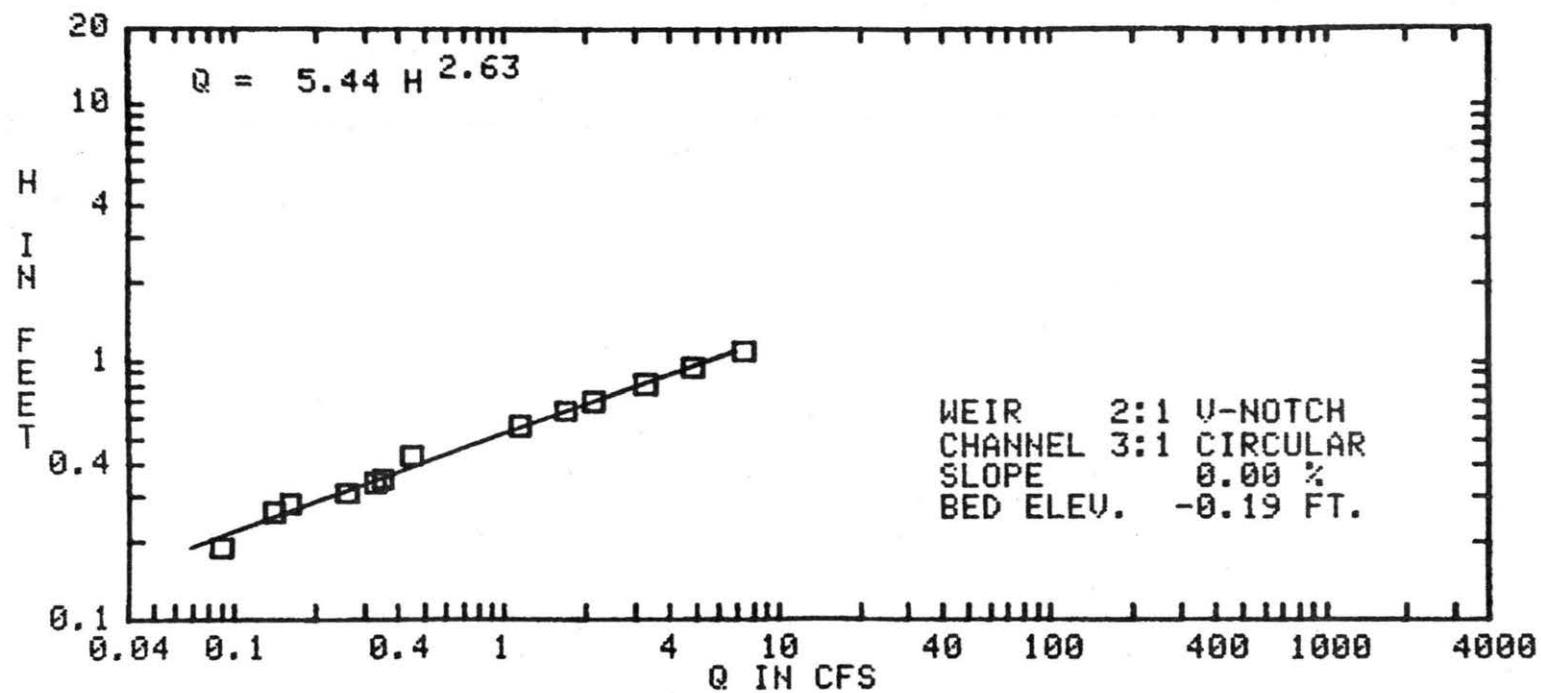

FIG. A-18 PLOT OF HEAD versus DISCHARGE DATA POINTS

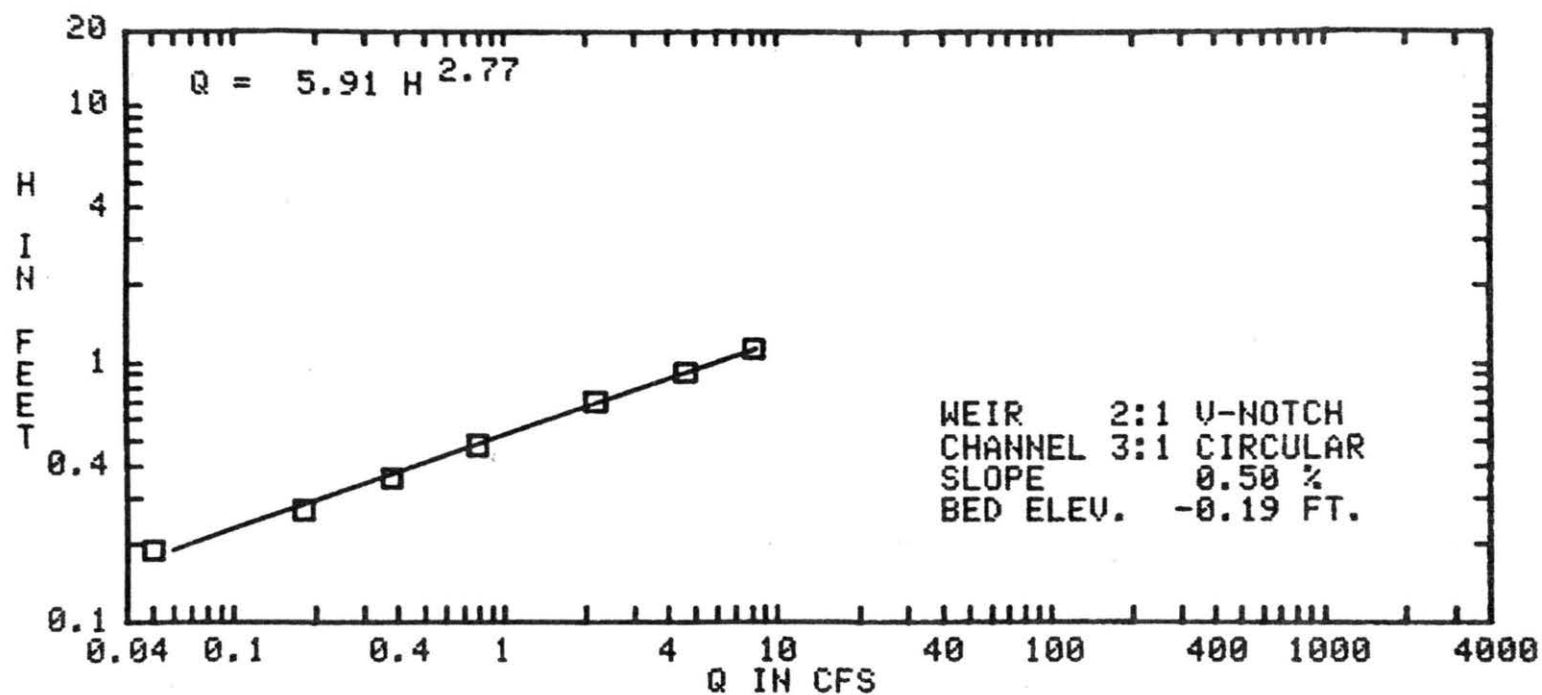

FIG. A-19 PLOT OF HEAD versus DISCHARGE DATA POINTS

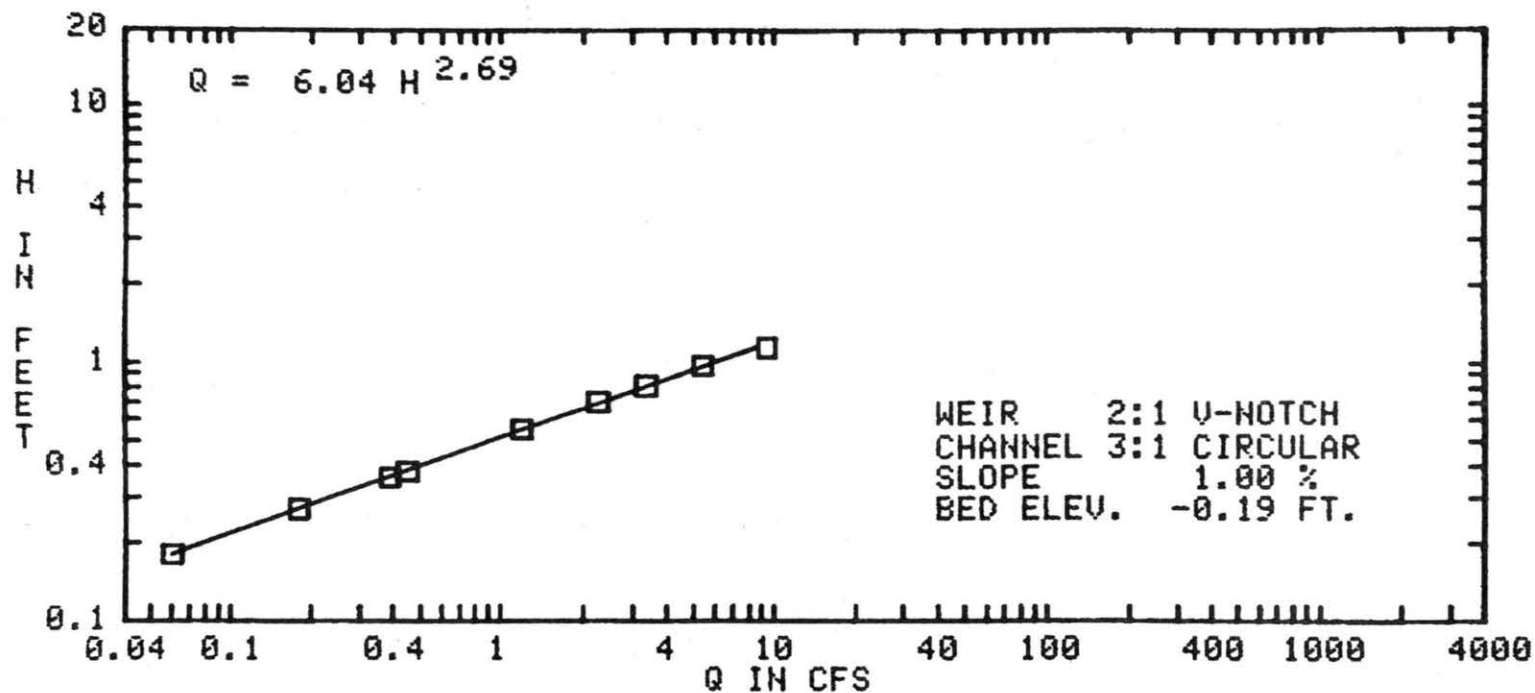

FIG. A-20 PLOT OF HEAD versus DISCHARGE DATA POINTS

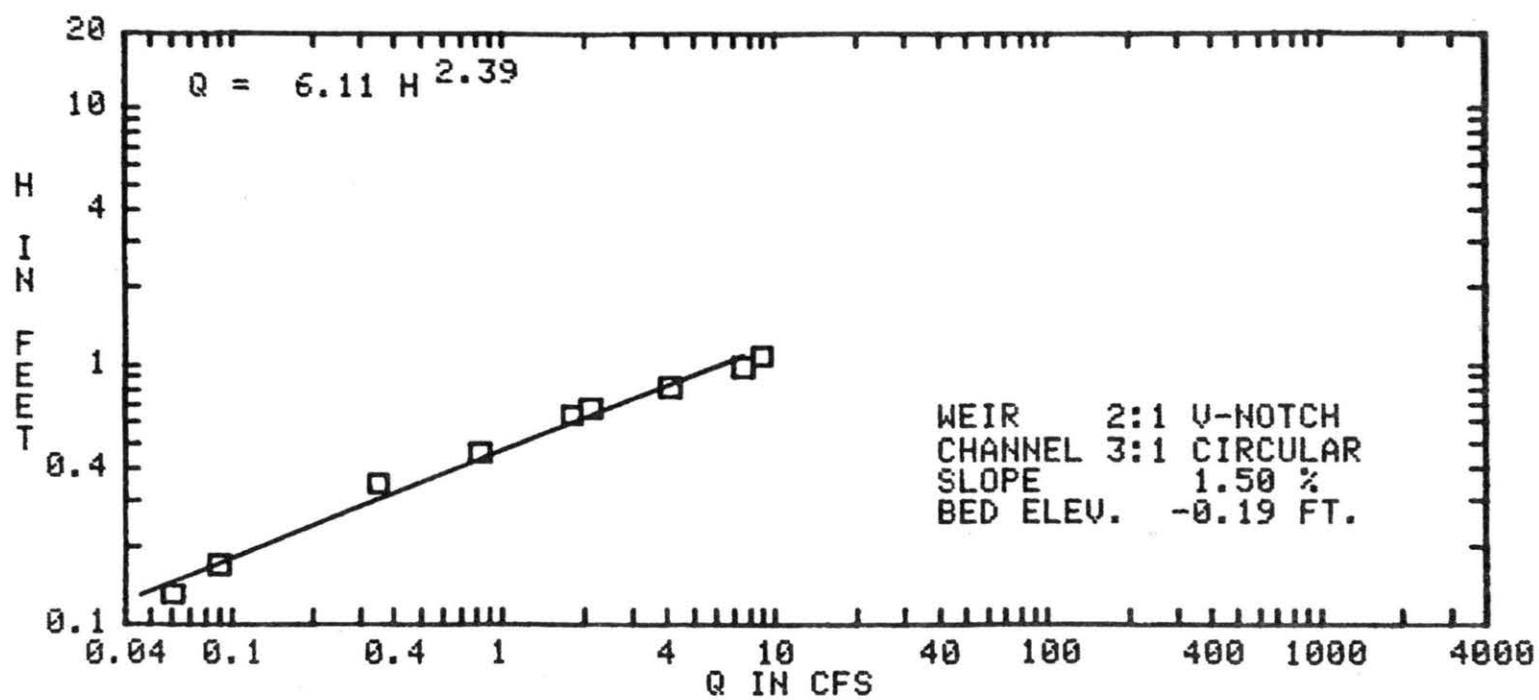

FIG. A-21 PLOT OF HEAD versus DISCHARGE DATA POINTS

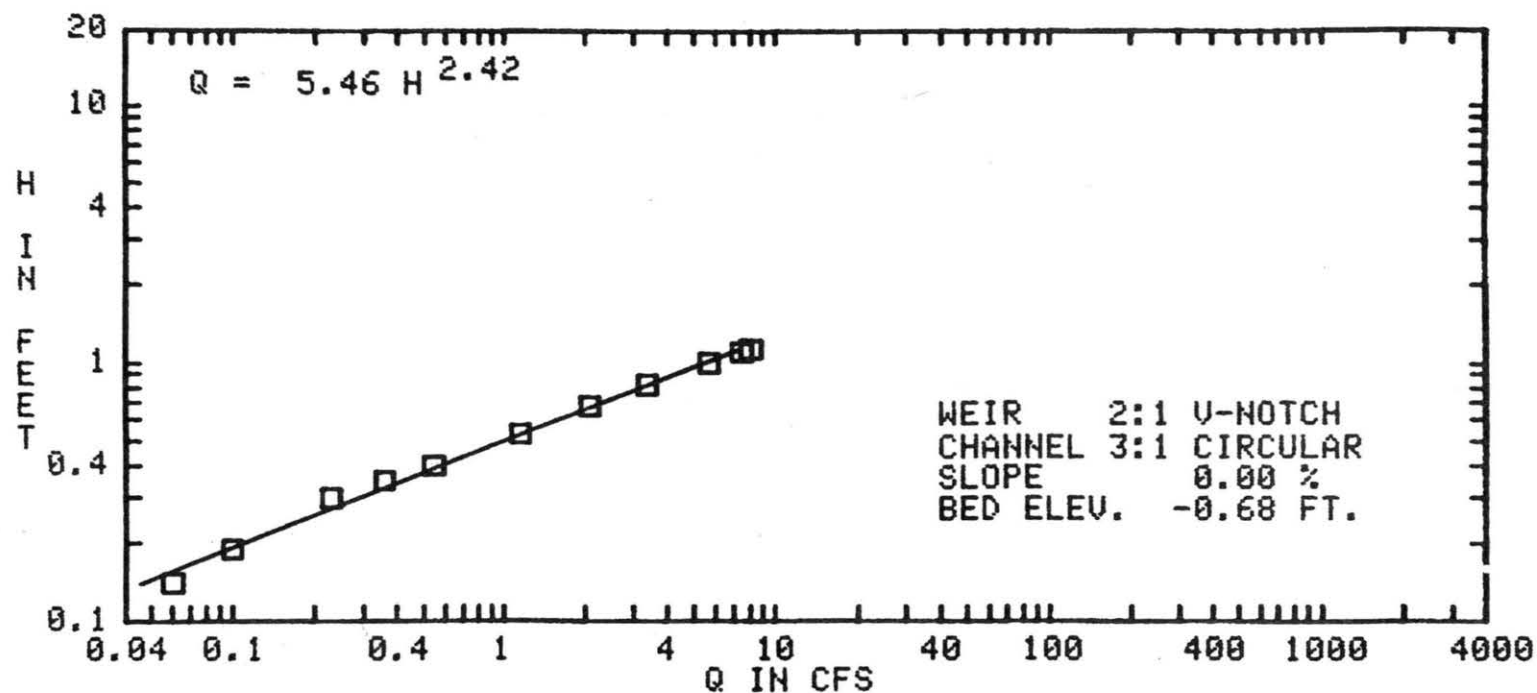

FIG. A-22 PLOT OF HEAD versus DISCHARGE DATA POINTS

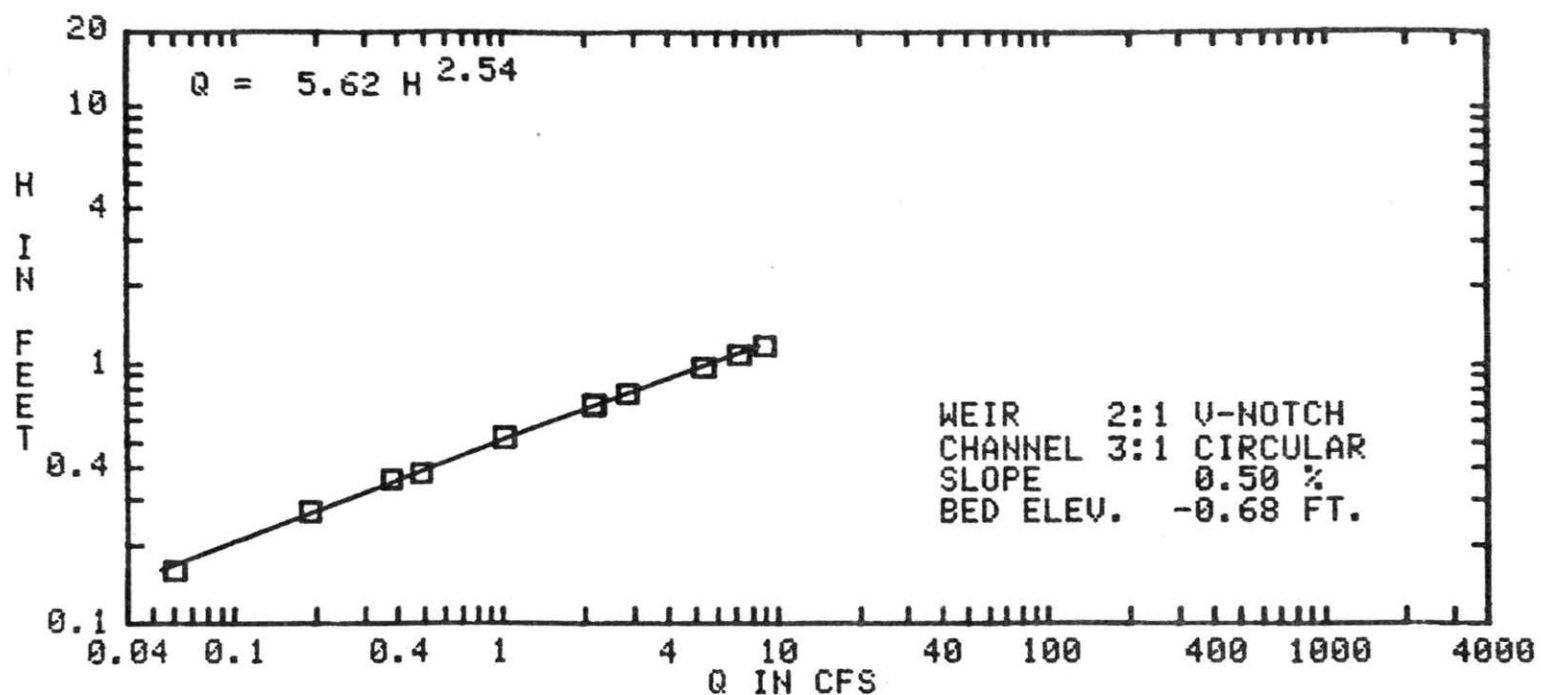

FIG. A-23 PLOT OF HEAD versus DISCHARGE DATA POINTS

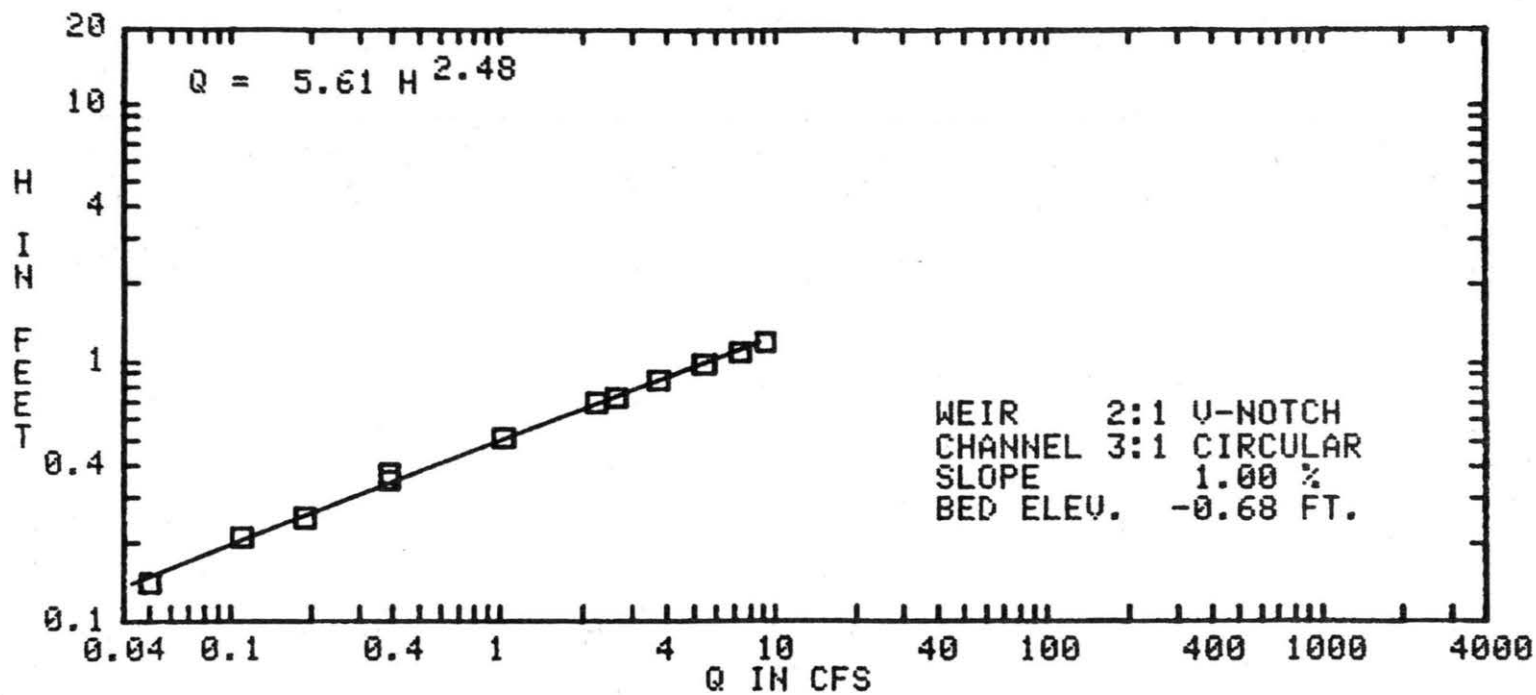

FIG. A-24 PLOT OF HEAD versus DISCHARGE DATA POINTS

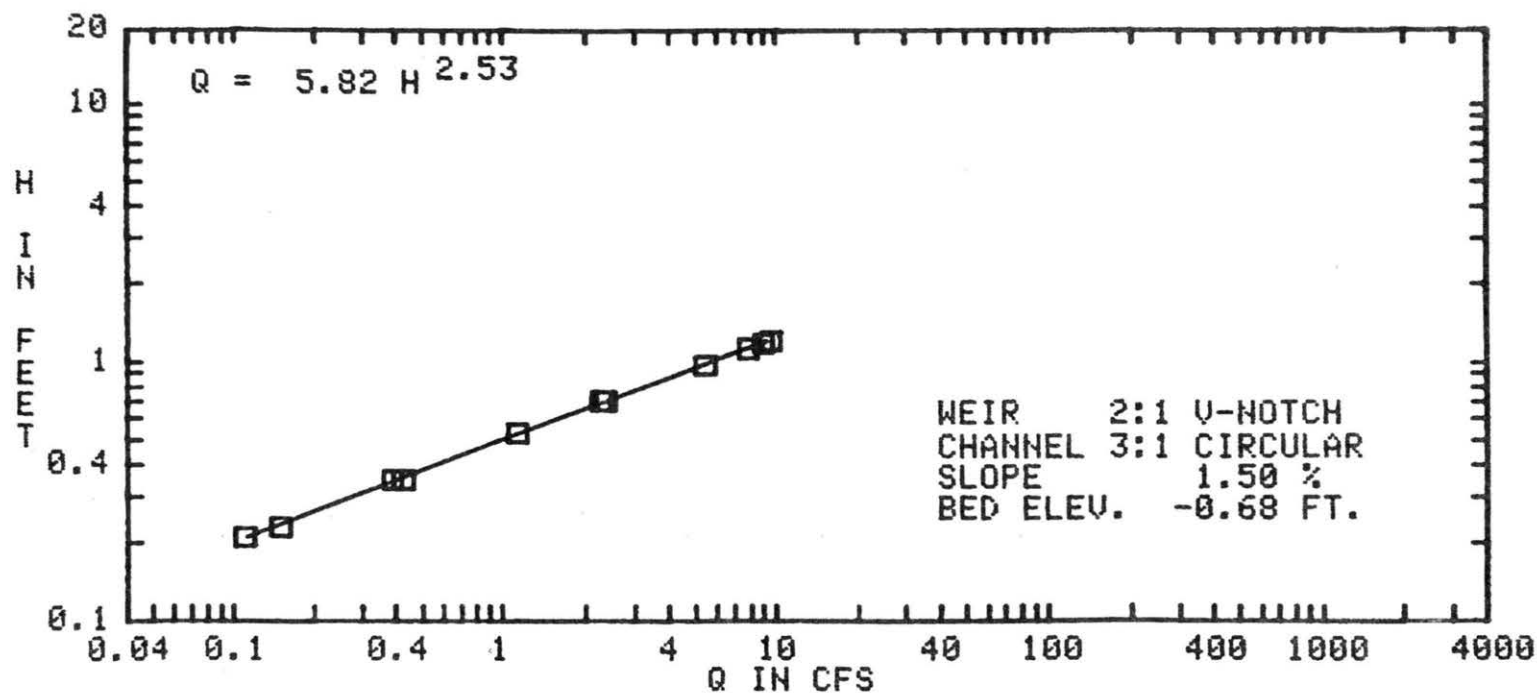

FIG. A-25 PLOT OF HEAD versus DISCHARGE DATA POINTS

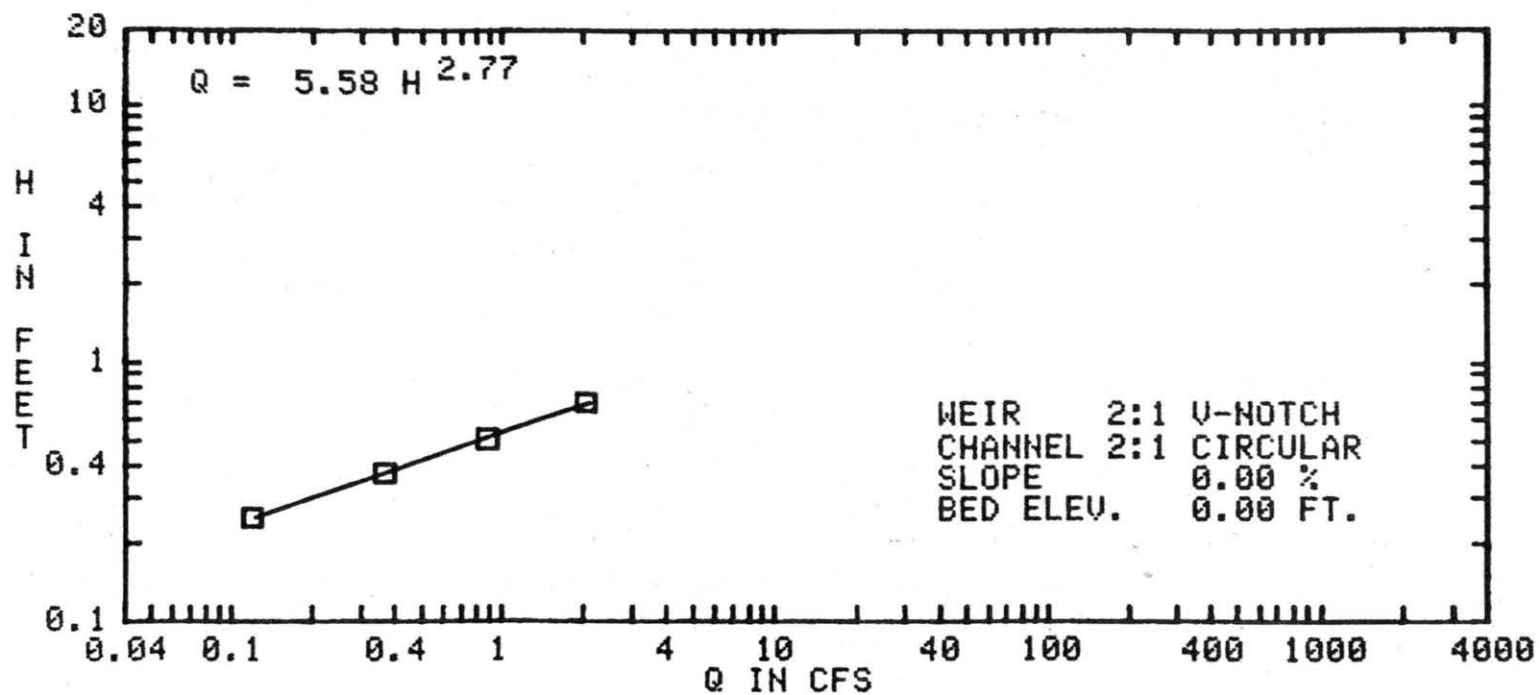

FIG. A-26 PLOT OF HEAD versus DISCHARGE DATA POINTS

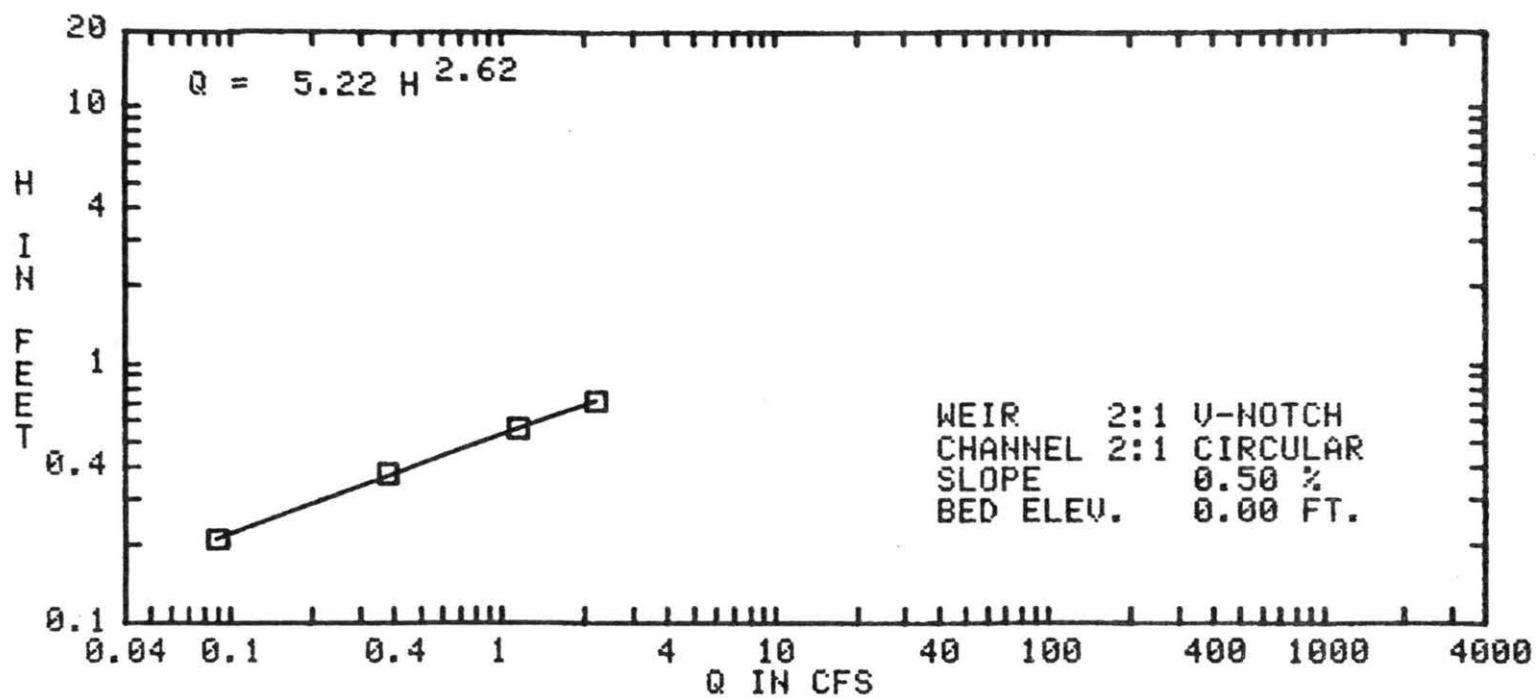

FIG. A-27 PLOT OF HEAD versus DISCHARGE DATA POINTS

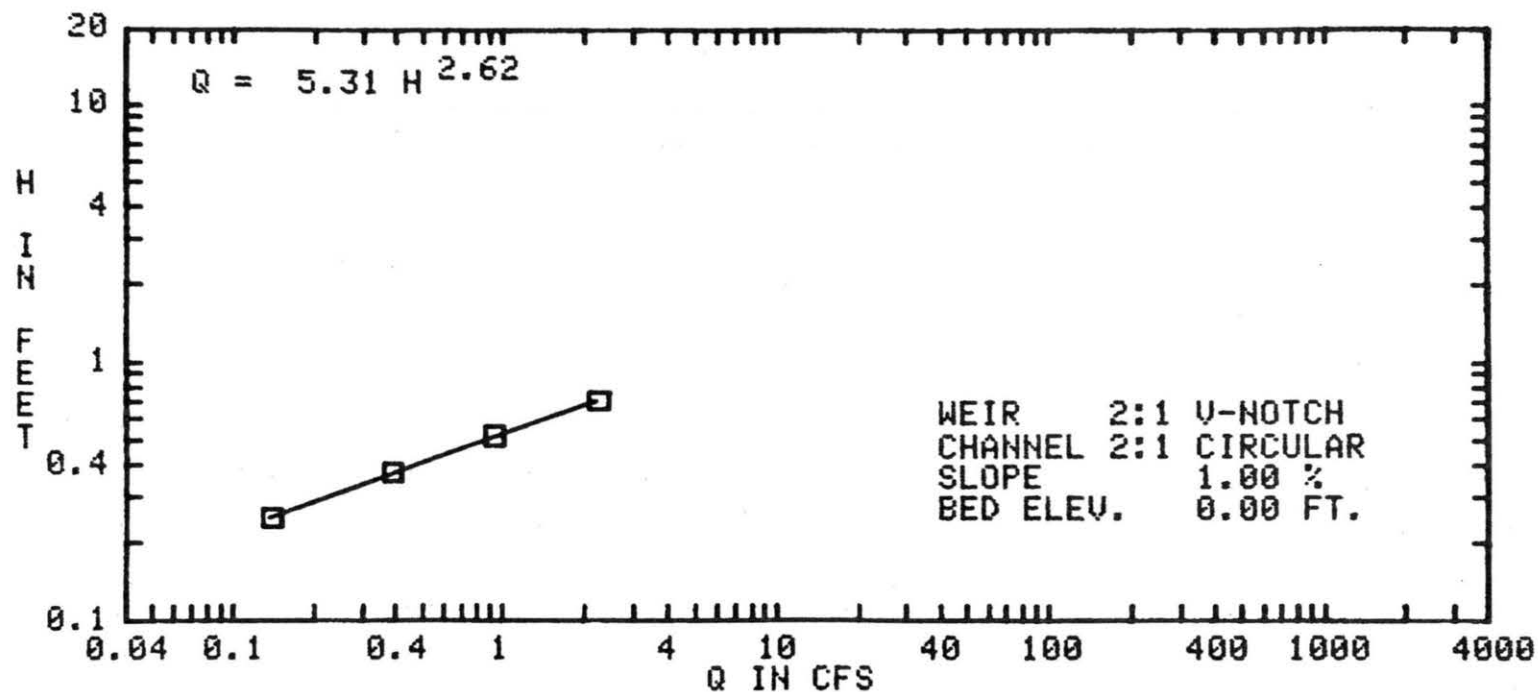

FIG. A-28 PLOT OF HEAD versus DISCHARGE DATA POINTS

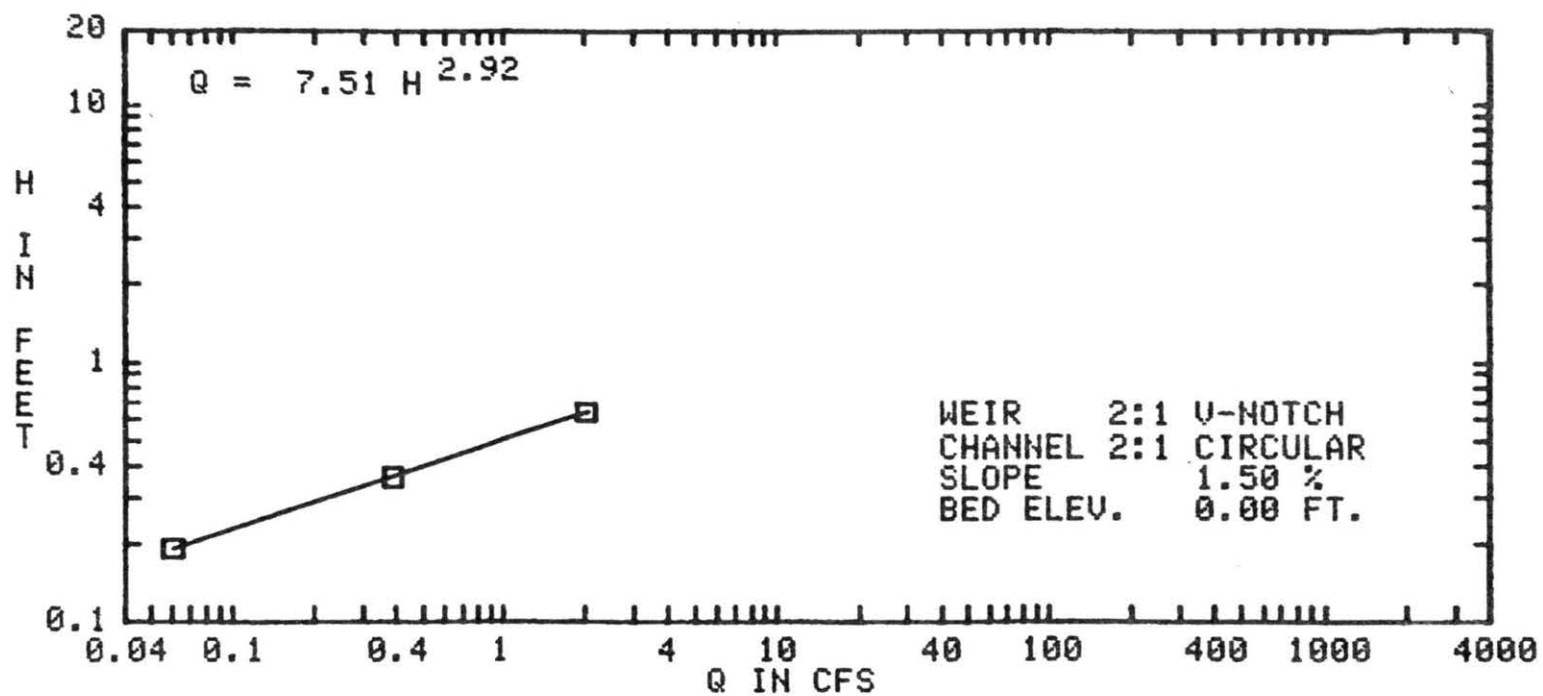

FIG. A-29 PLOT OF HEAD versus DISCHARGE DATA POINTS

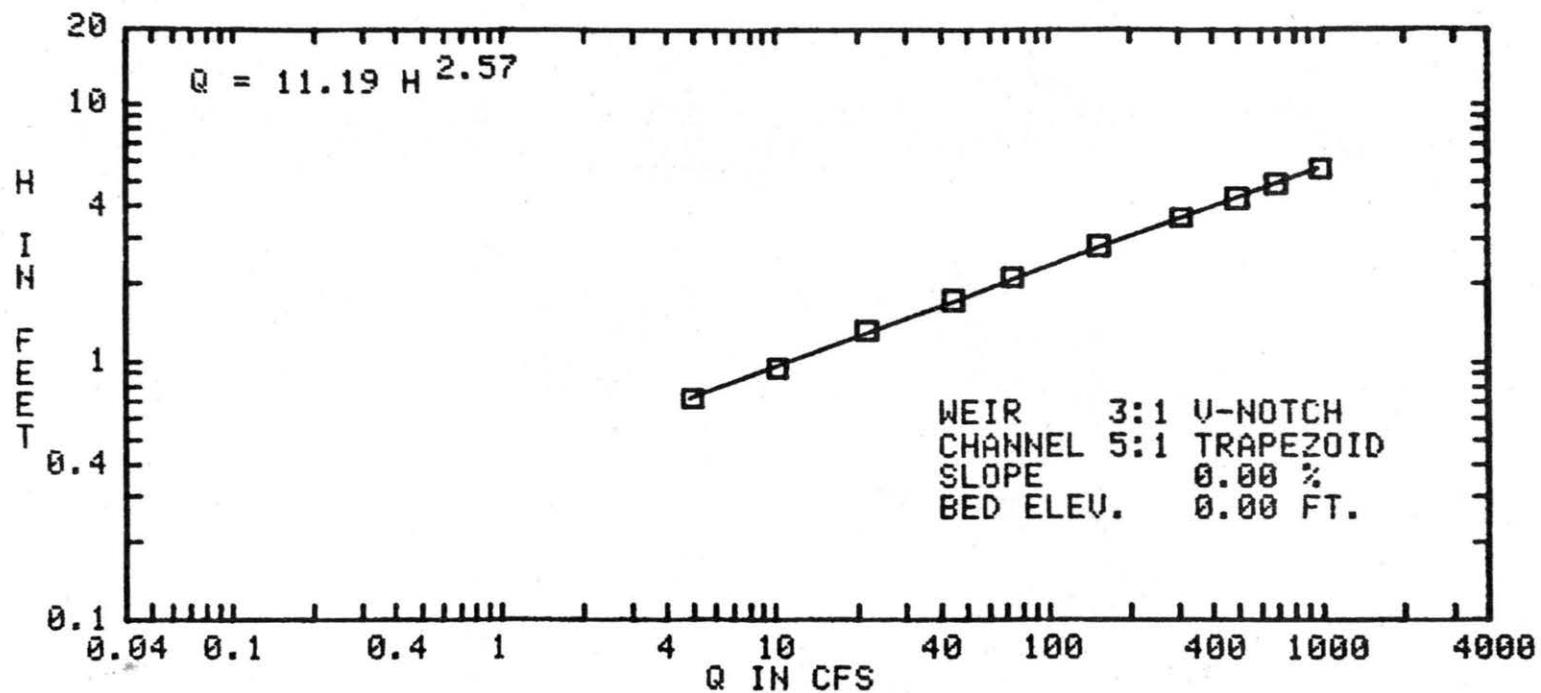

FIG. A-30 PLOT OF HEAD versus DISCHARGE DATA POINTS

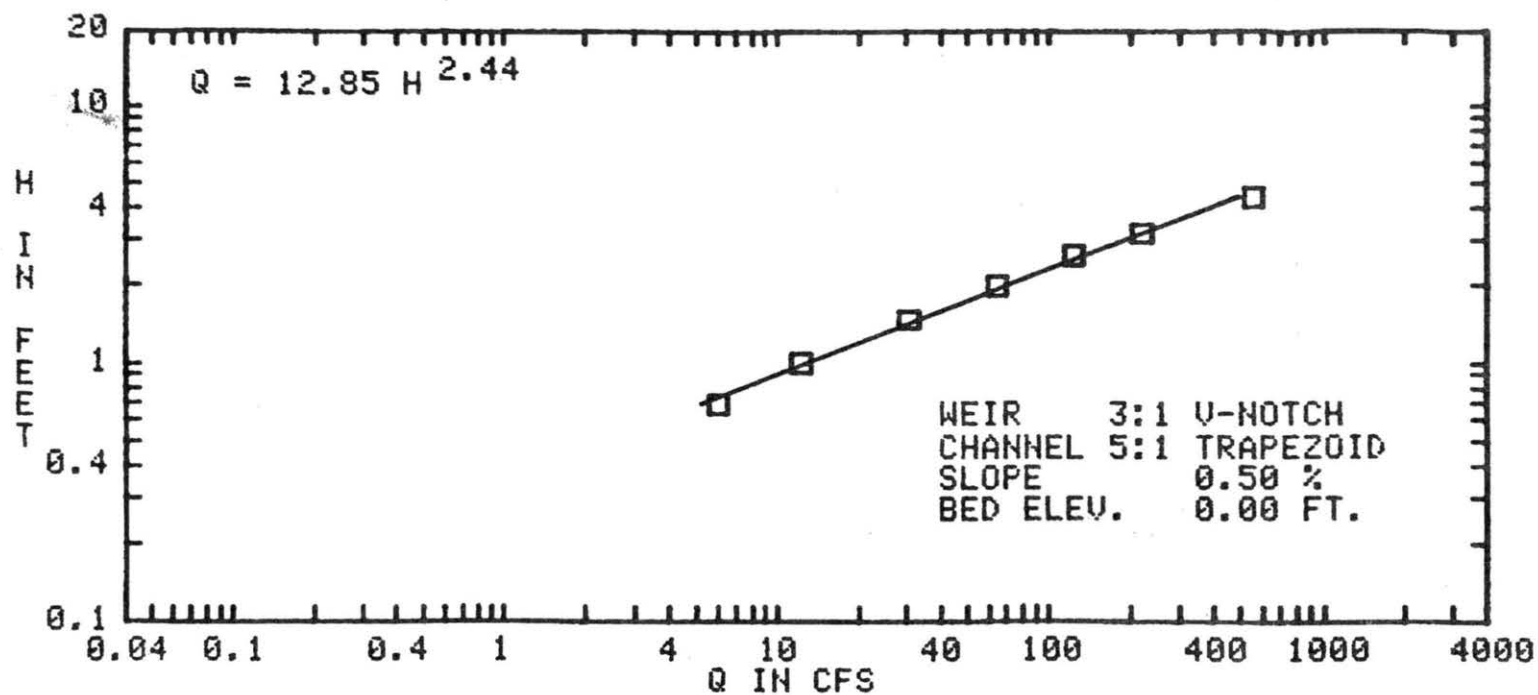

FIG. A-31 PLOT OF HEAD versus DISCHARGE DATA POINTS

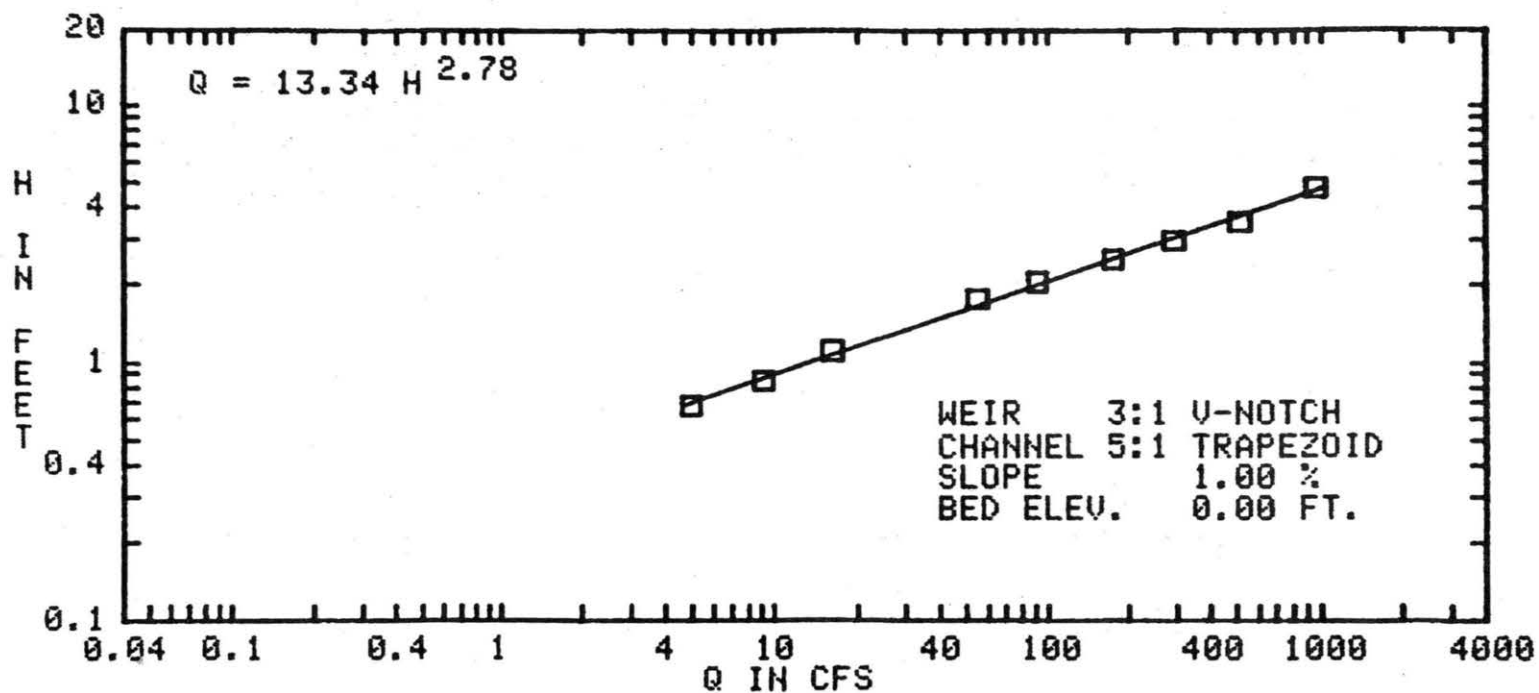

FIG. A-32 PLOT OF HEAD versus DISCHARGE DATA POINTS

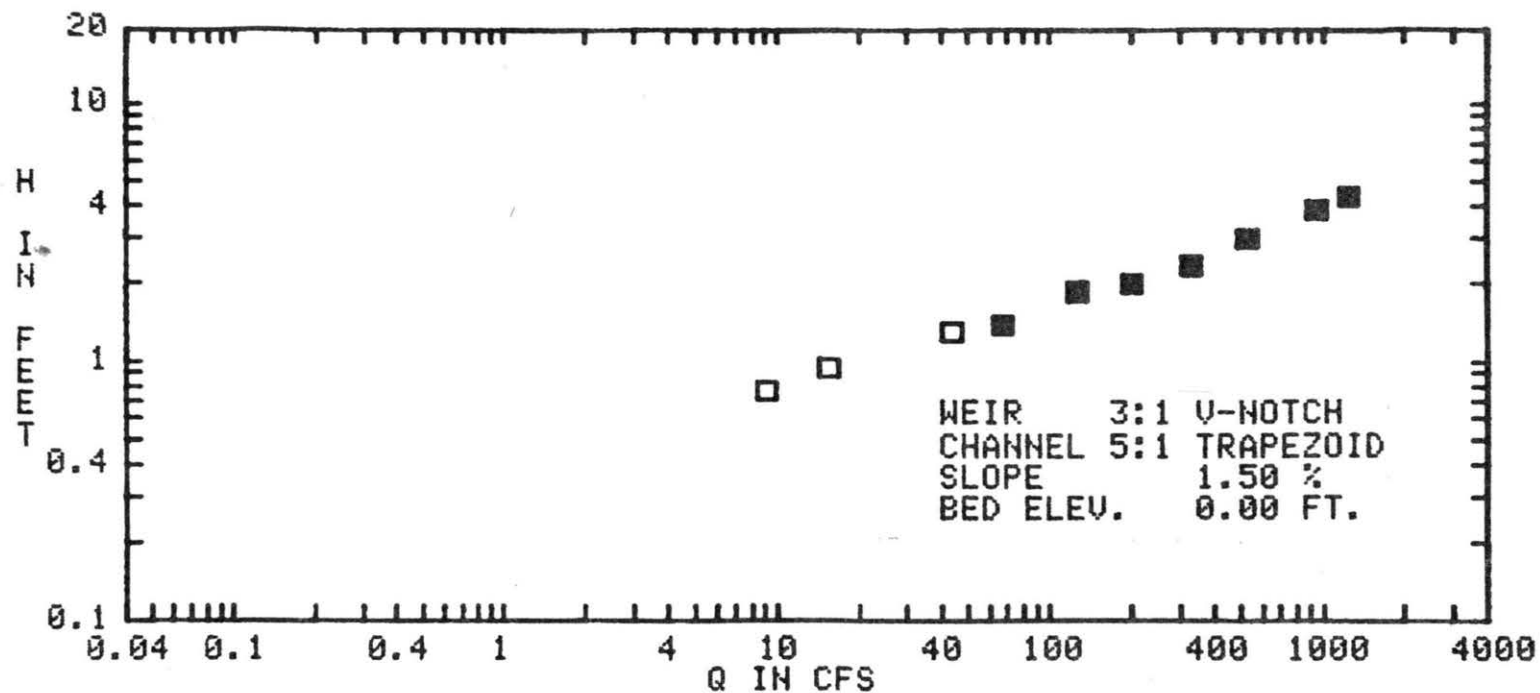

FIG. A-33 PLOT OF HEAD versus DISCHARGE DATA POINTS

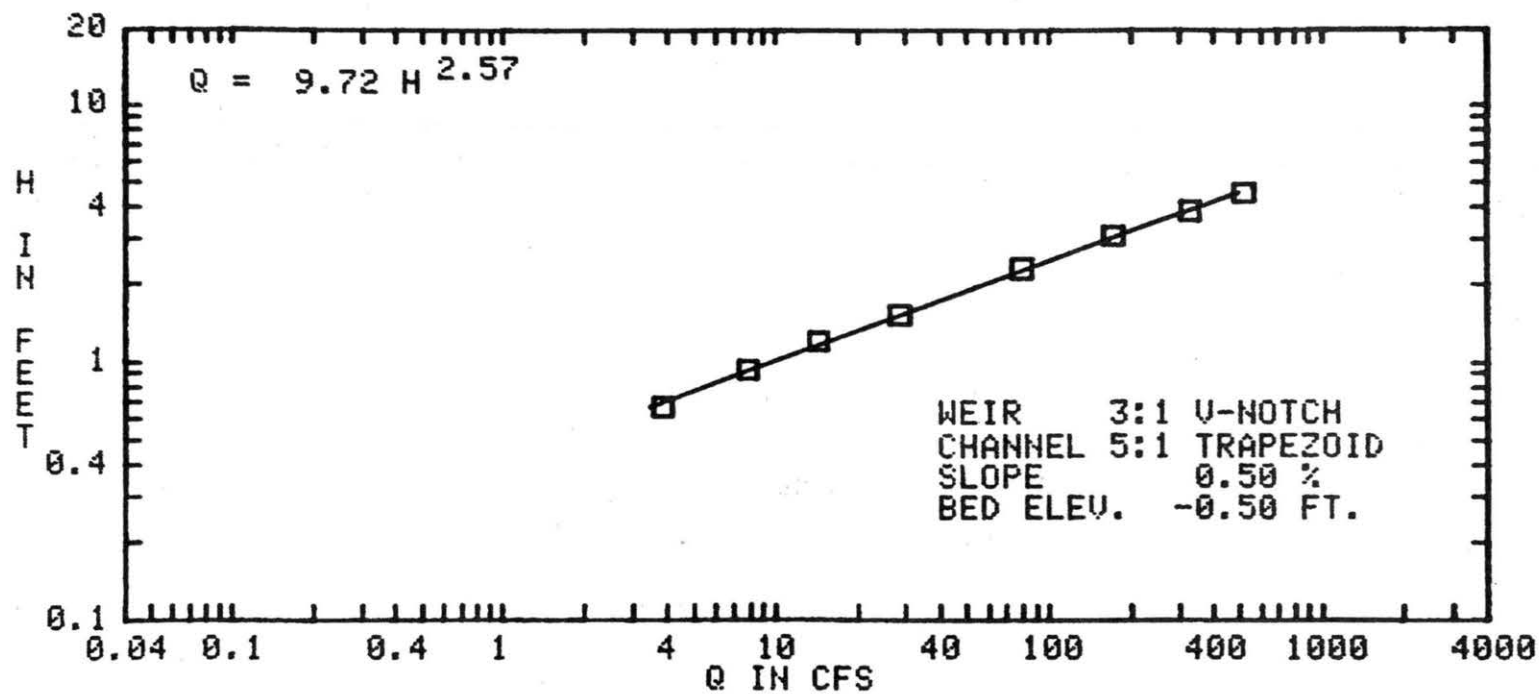

FIG. A-34 PLOT OF HEAD versus DISCHARGE DATA POINTS

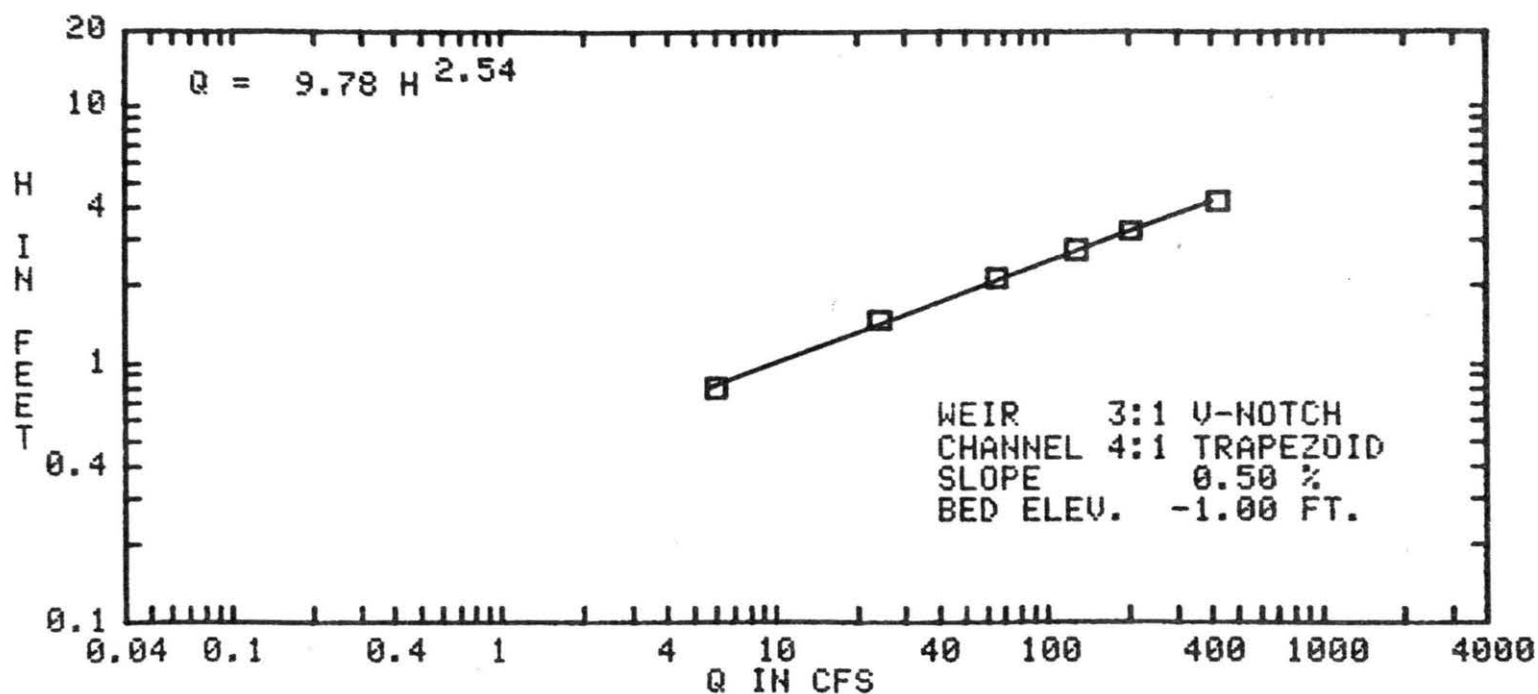

FIG. A-35 PLOT OF HEAD versus DISCHARGE DATA POINTS

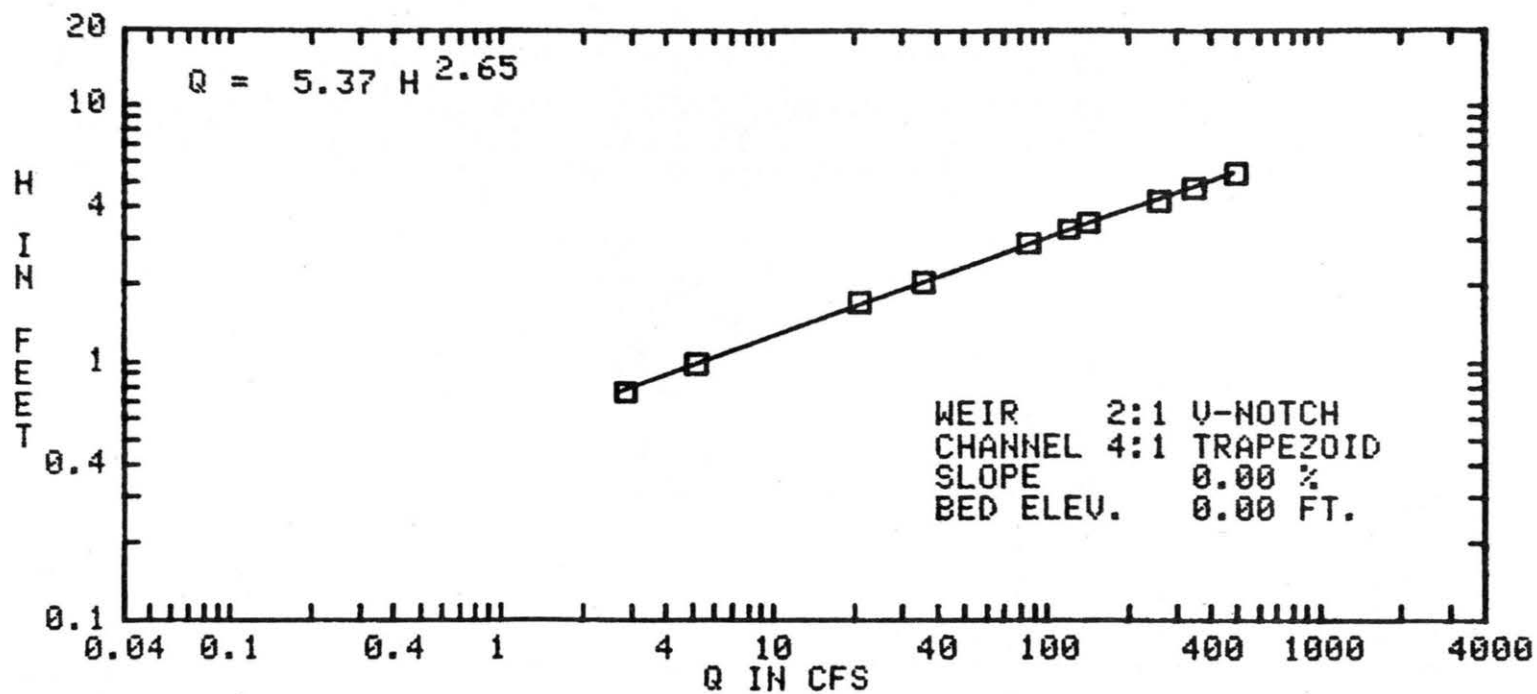

FIG. A-36 PLOT OF HEAD versus DISCHARGE DATA POINTS

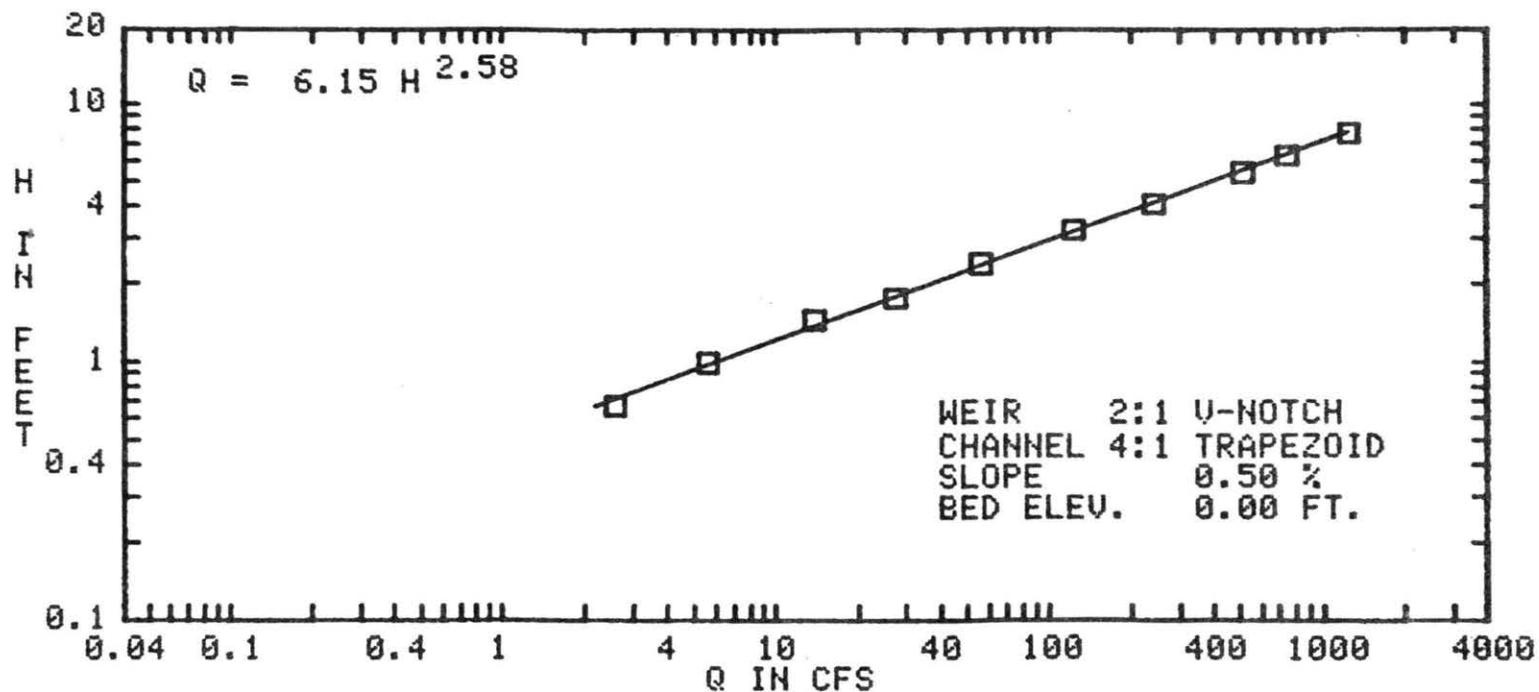

FIG. A-37 PLOT OF HEAD versus DISCHARGE DATA POINTS

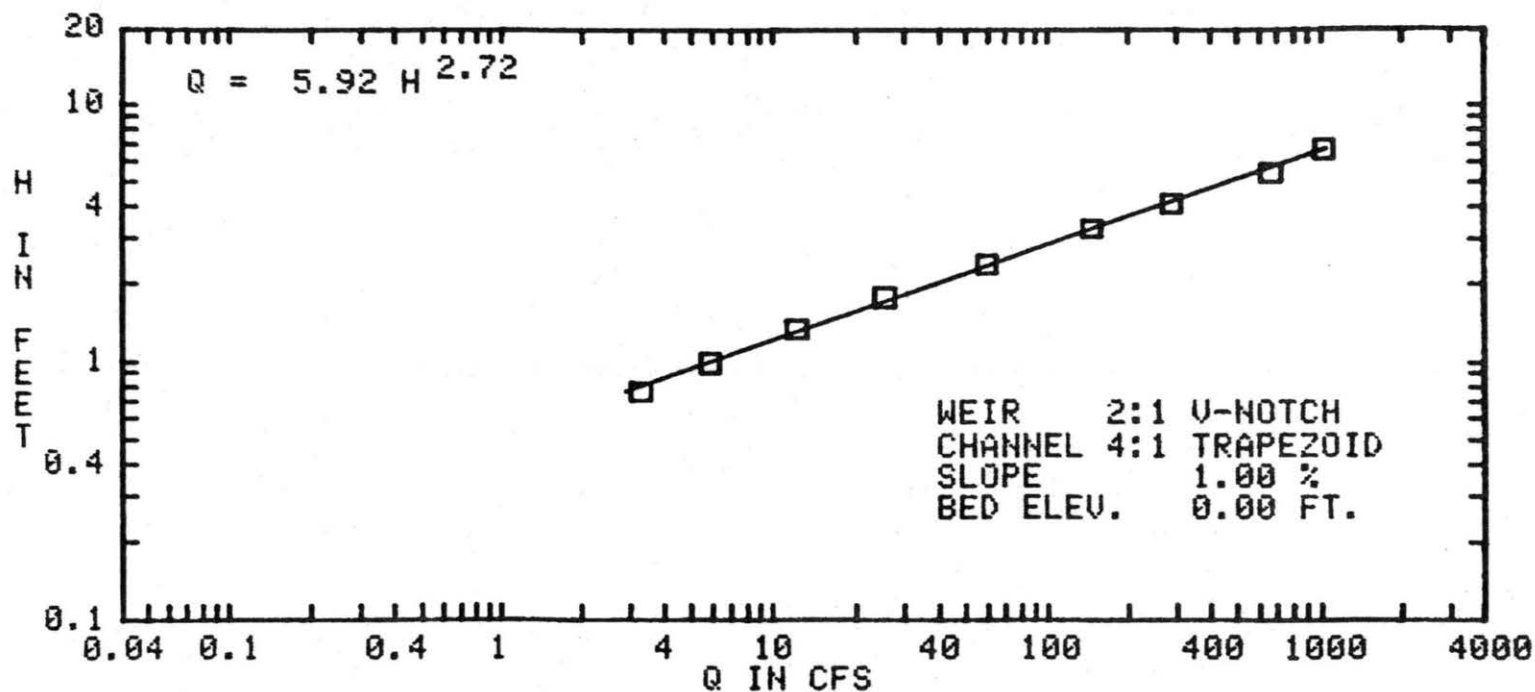

FIG. A-38 PLOT OF HEAD versus DISCHARGE DATA POINTS

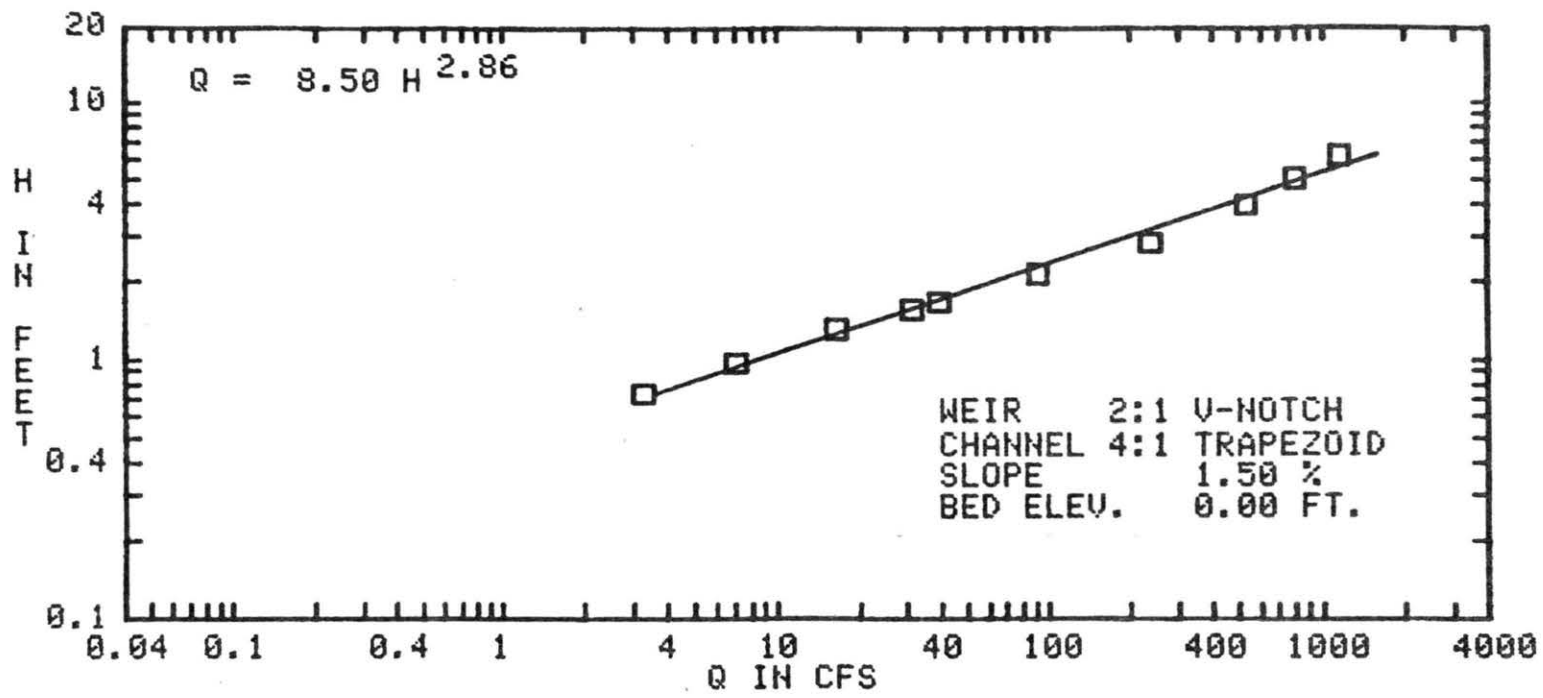

FIG. A-39 PLOT OF HEAD versus DISCHARGE DATA POINTS

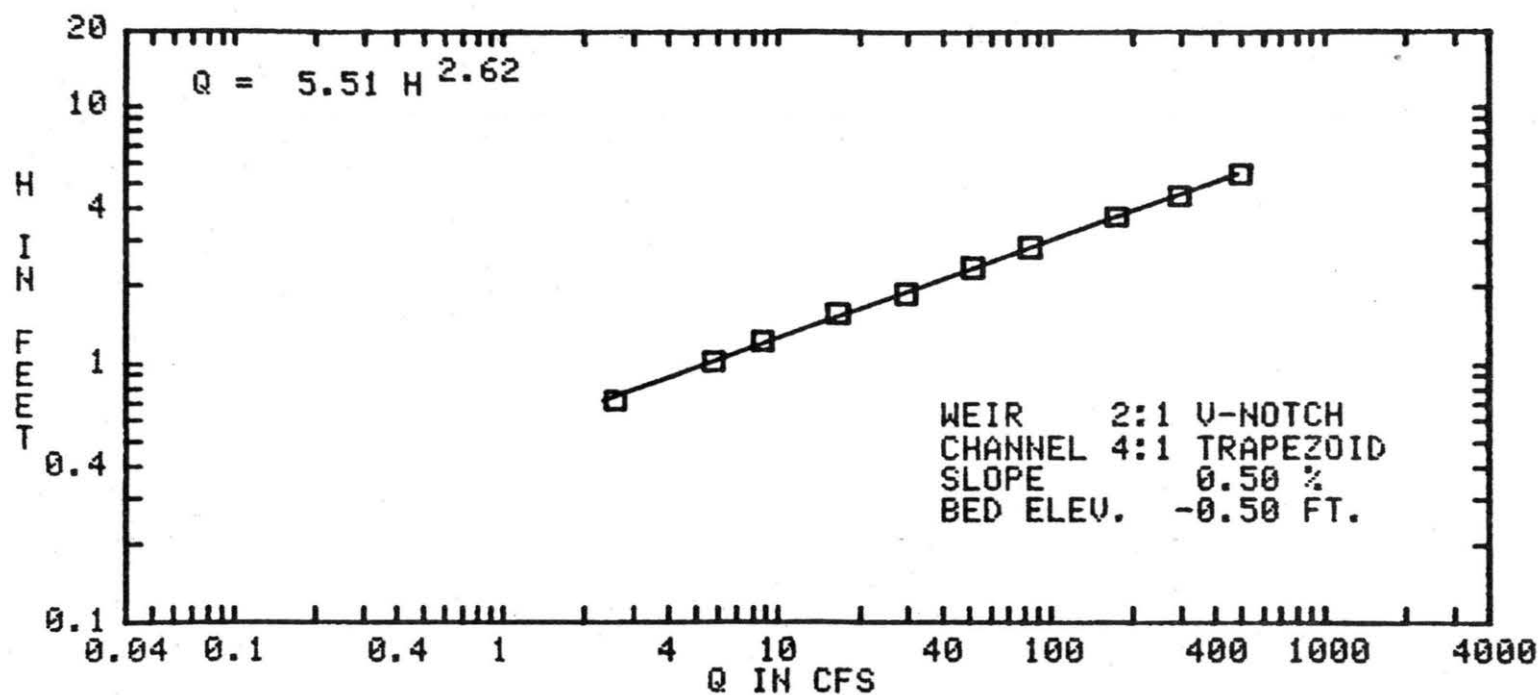

FIG. A-40 PLOT OF HEAD versus DISCHARGE DATA POINTS

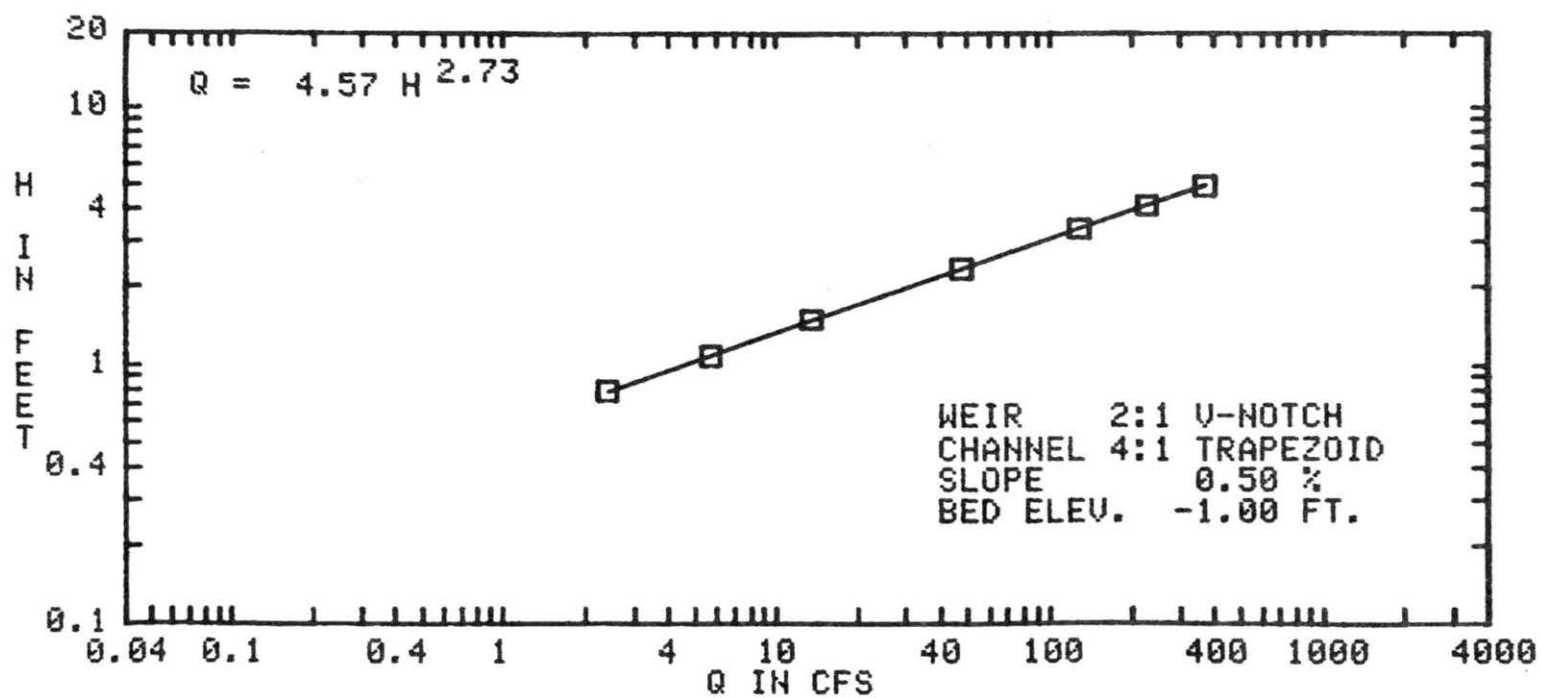

FIG. A-41 PLOT OF HEAD versus DISCHARGE DATA POINTS

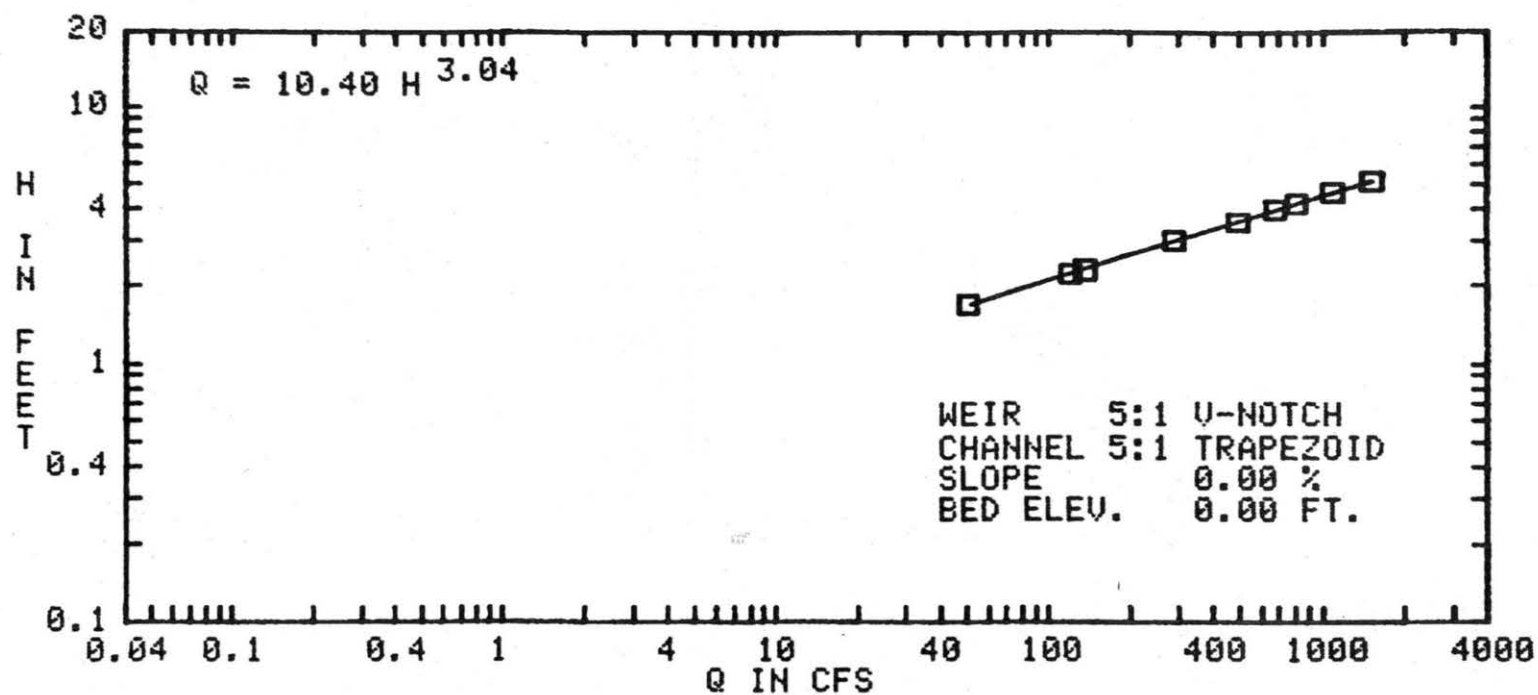

FIG. A-42 PLOT OF HEAD versus DISCHARGE DATA POINTS

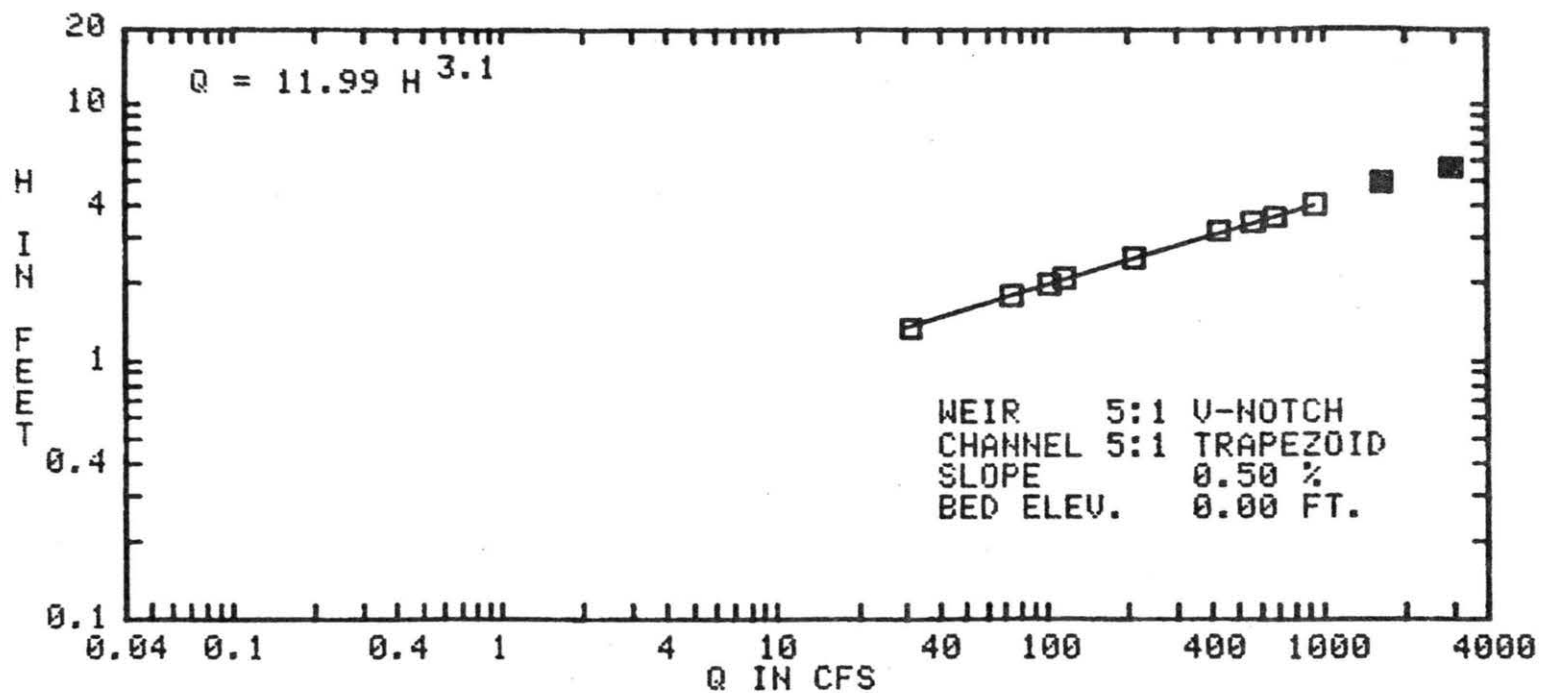

FIG. A-43 PLOT OF HEAD versus DISCHARGE DATA POINTS

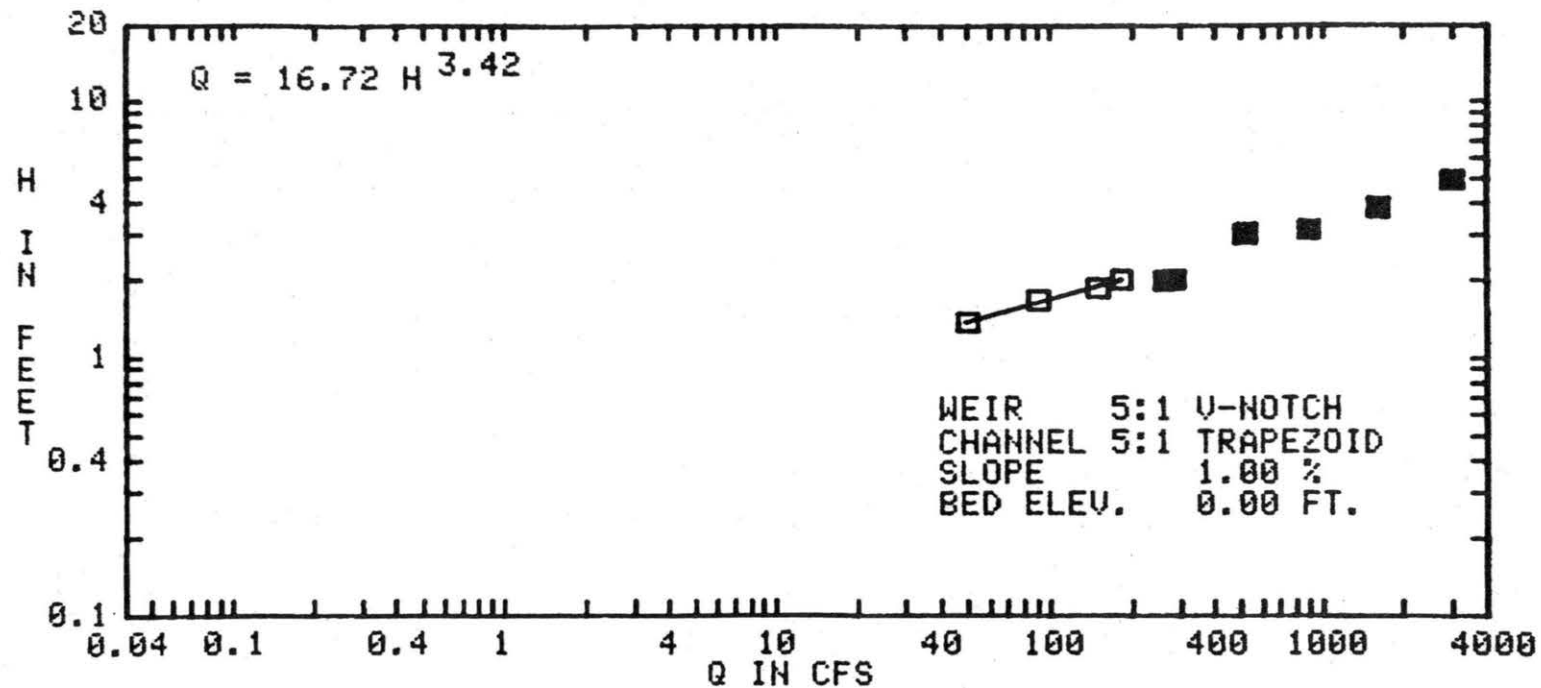

FIG. A-44 PLOT OF HEAD versus DISCHARGE DATA POINTS

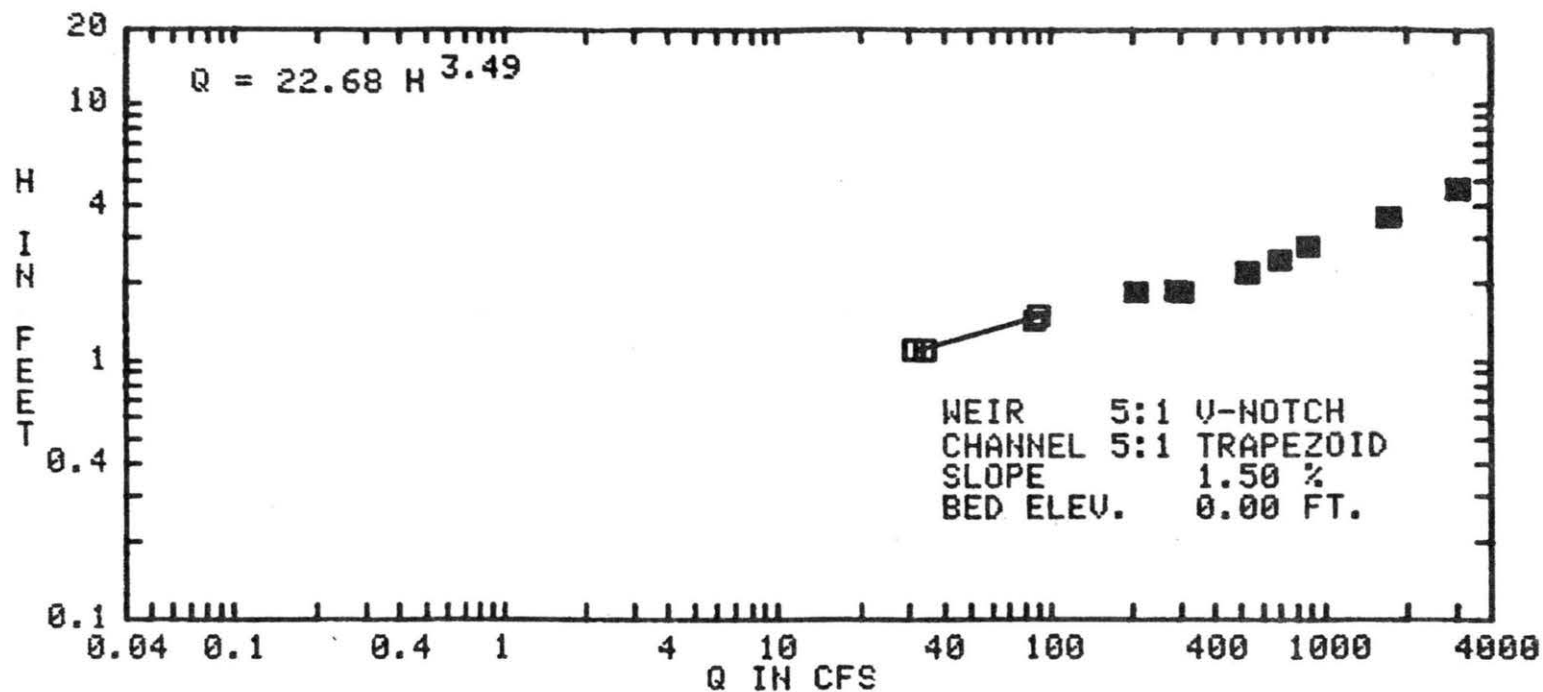

FIG. A-45 PLOT OF HEAD versus DISCHARGE DATA POINTS

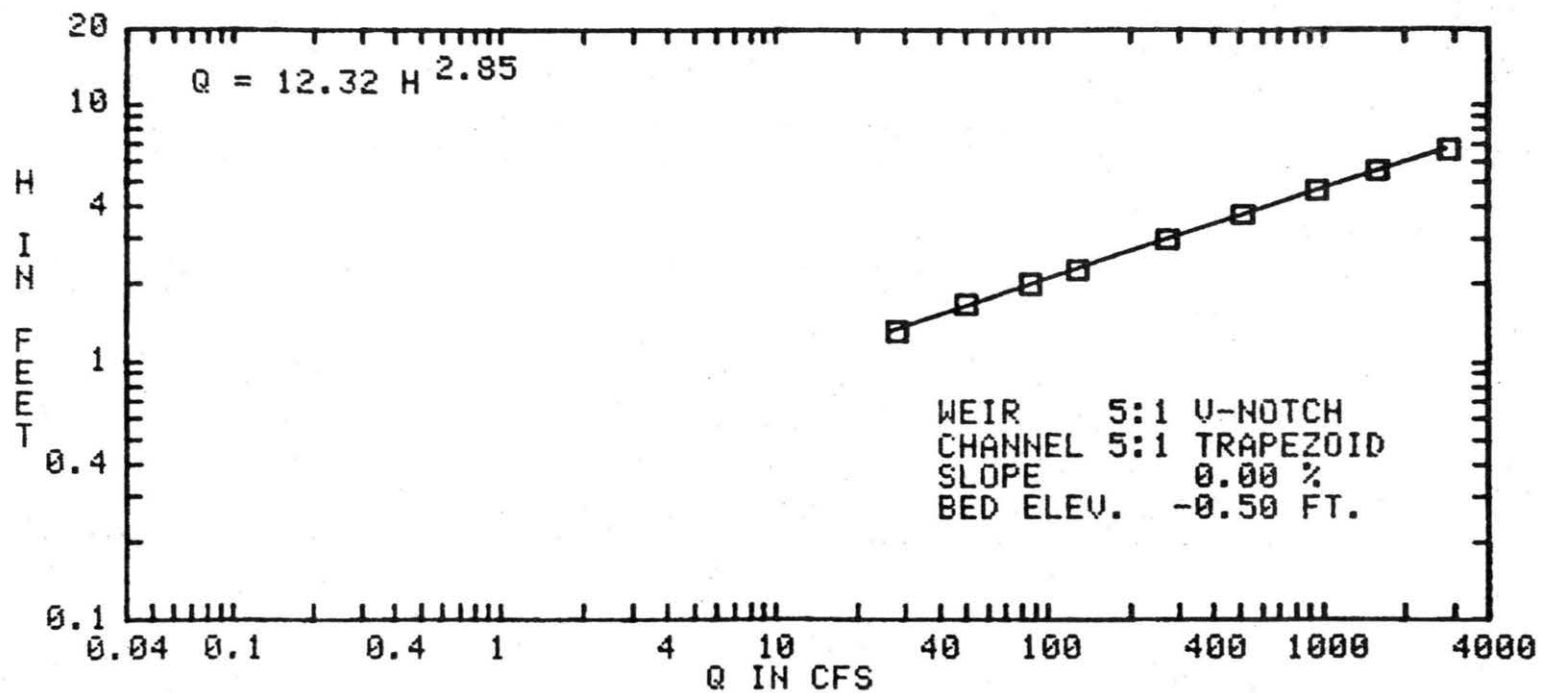

FIG. A-46 PLOT OF HEAD versus DISCHARGE DATA POINTS

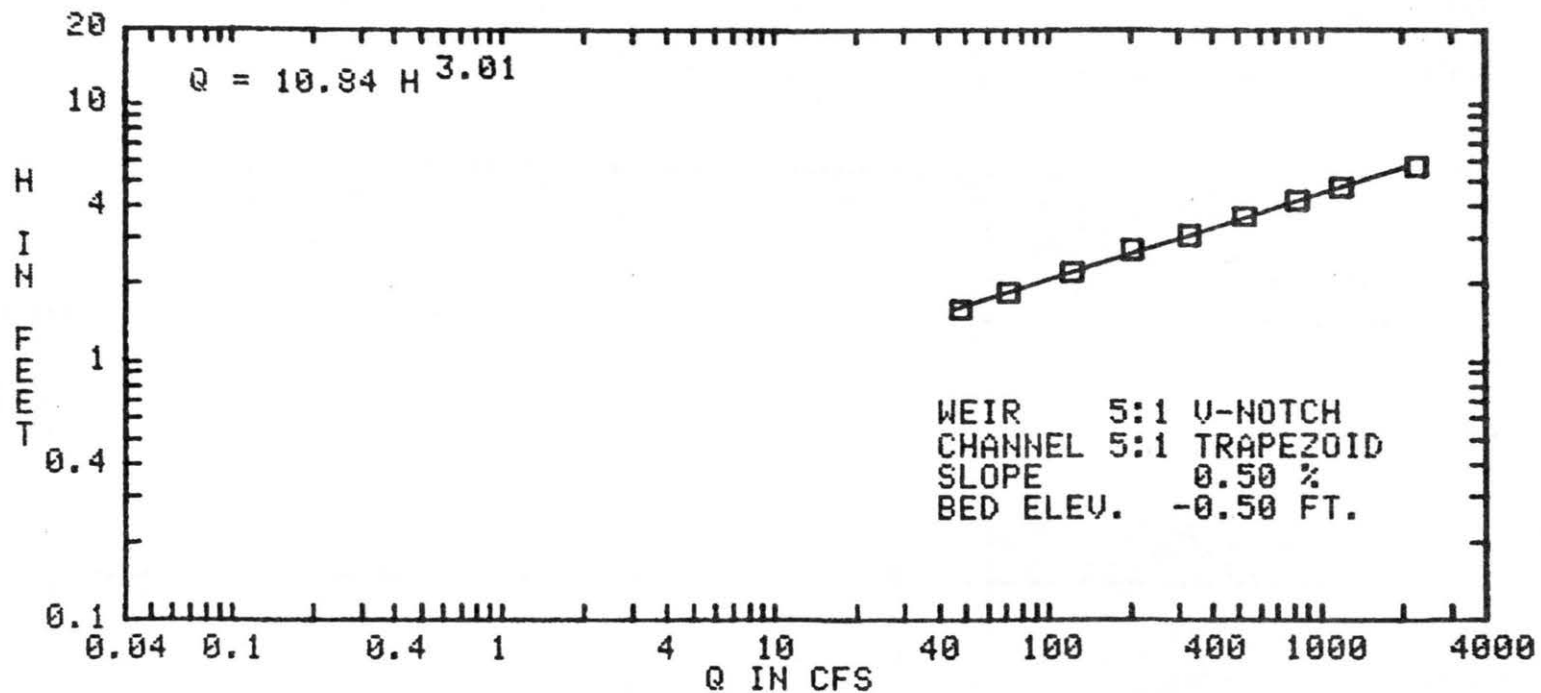

FIG. A-47 PLOT OF HEAD versus DISCHARGE DATA POINTS

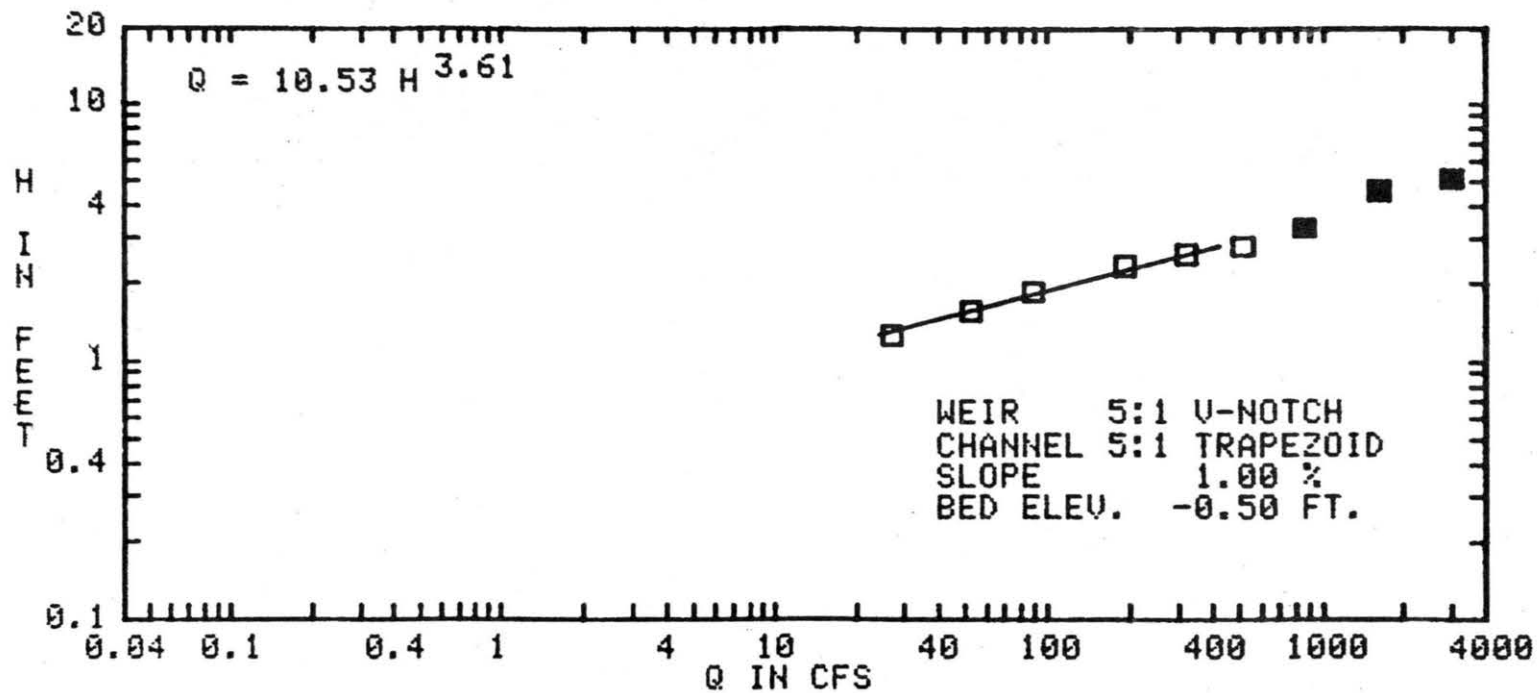

FIG. A-48 PLOT OF HEAD versus DISCHARGE DATA POINTS

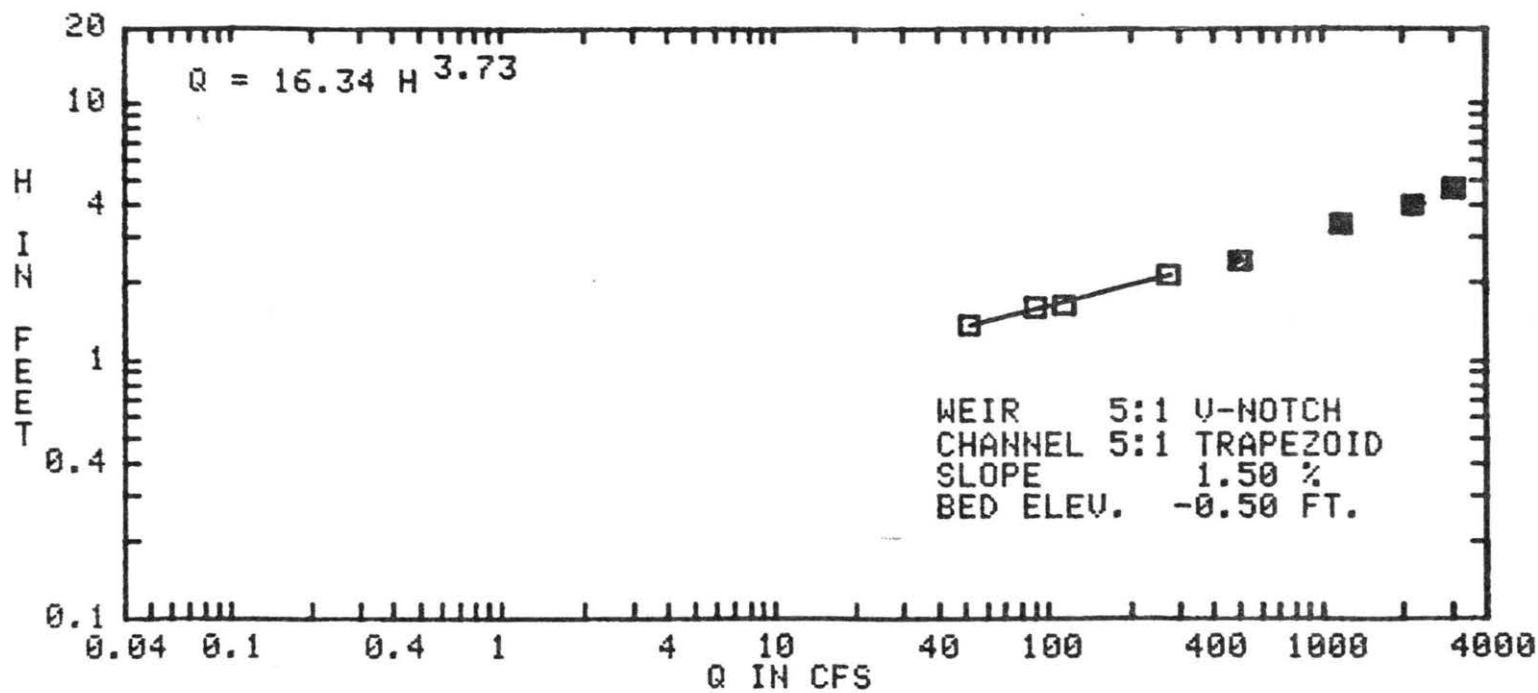

FIG. A-49 PLOT OF HEAD versus DISCHARGE DATA POINTS

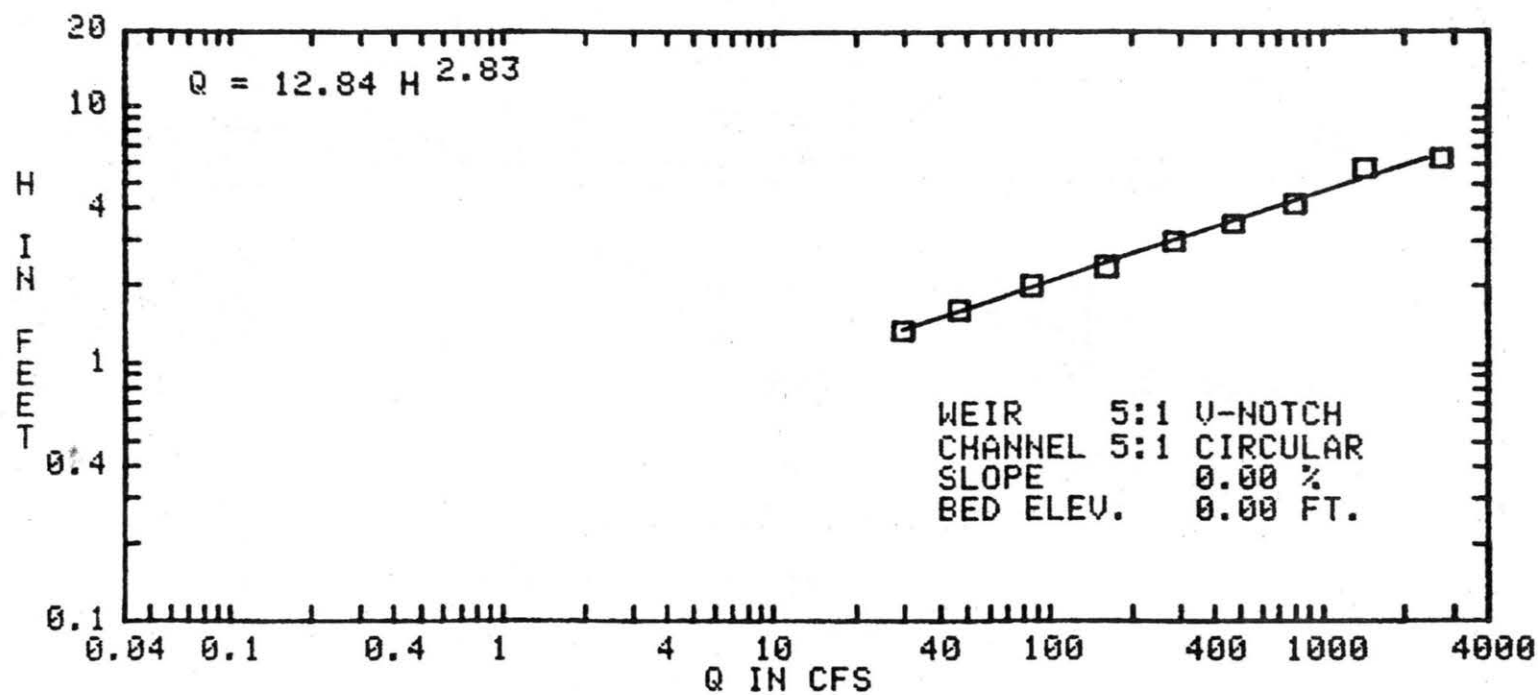

FIG. A-50 PLOT OF HEAD versus DISCHARGE DATA POINTS

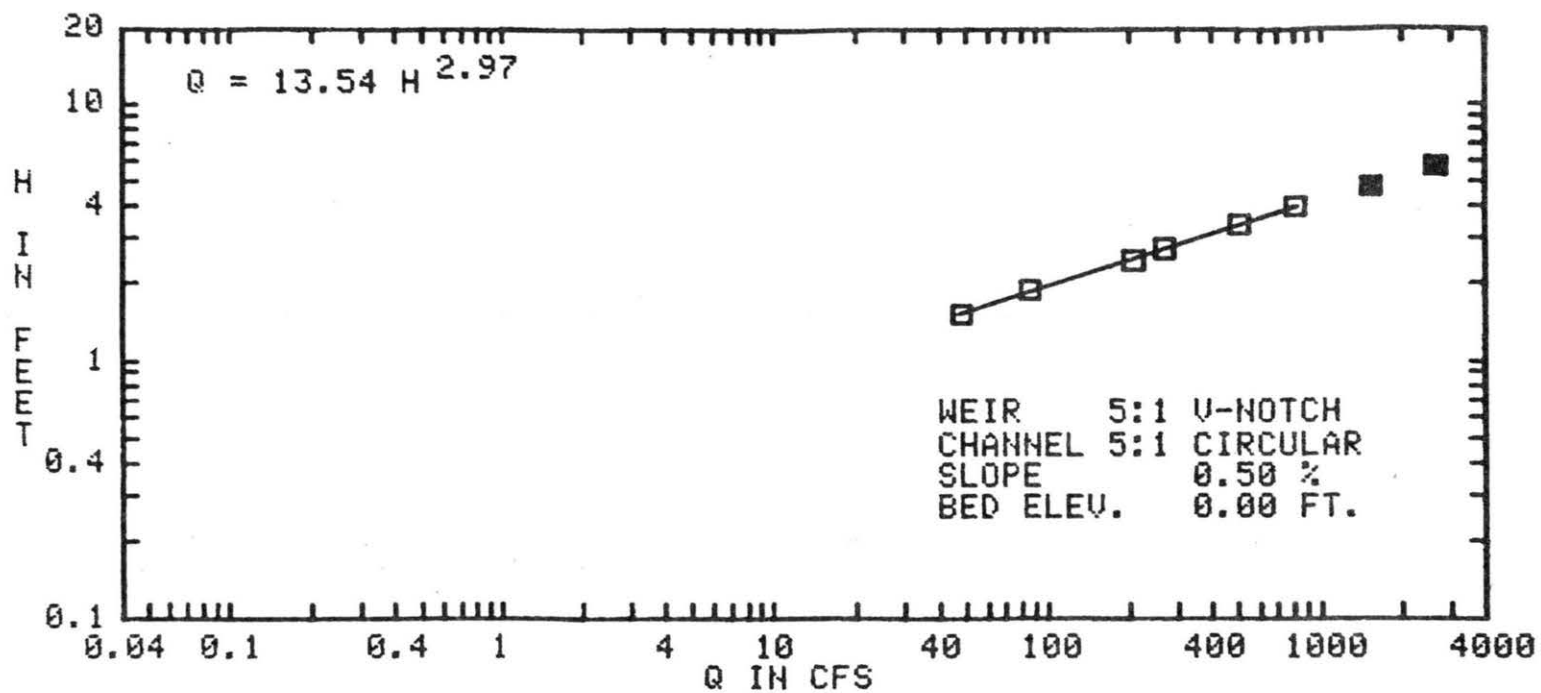

FIG. A-51 PLOT OF HEAD versus DISCHARGE DATA POINTS

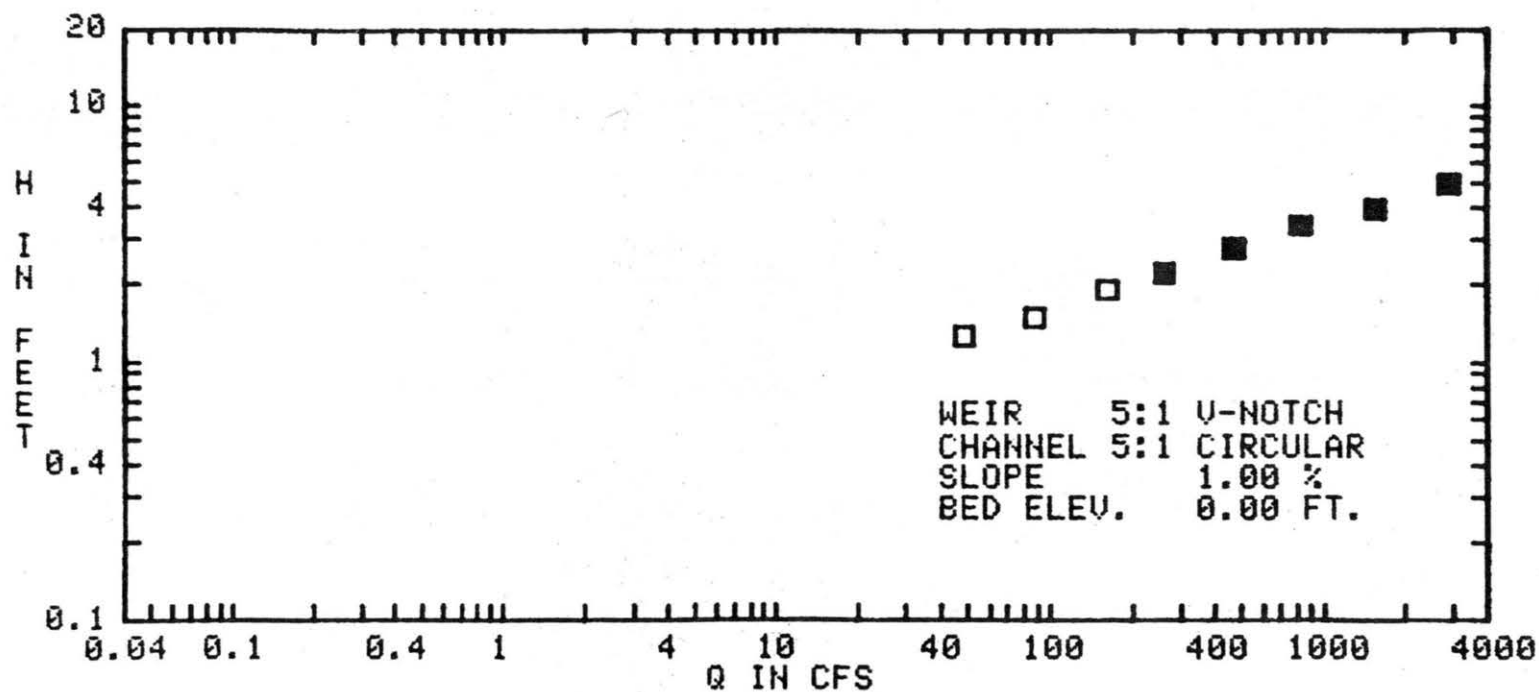

FIG. A-52 PLOT OF HEAD versus DISCHARGE DATA POINTS

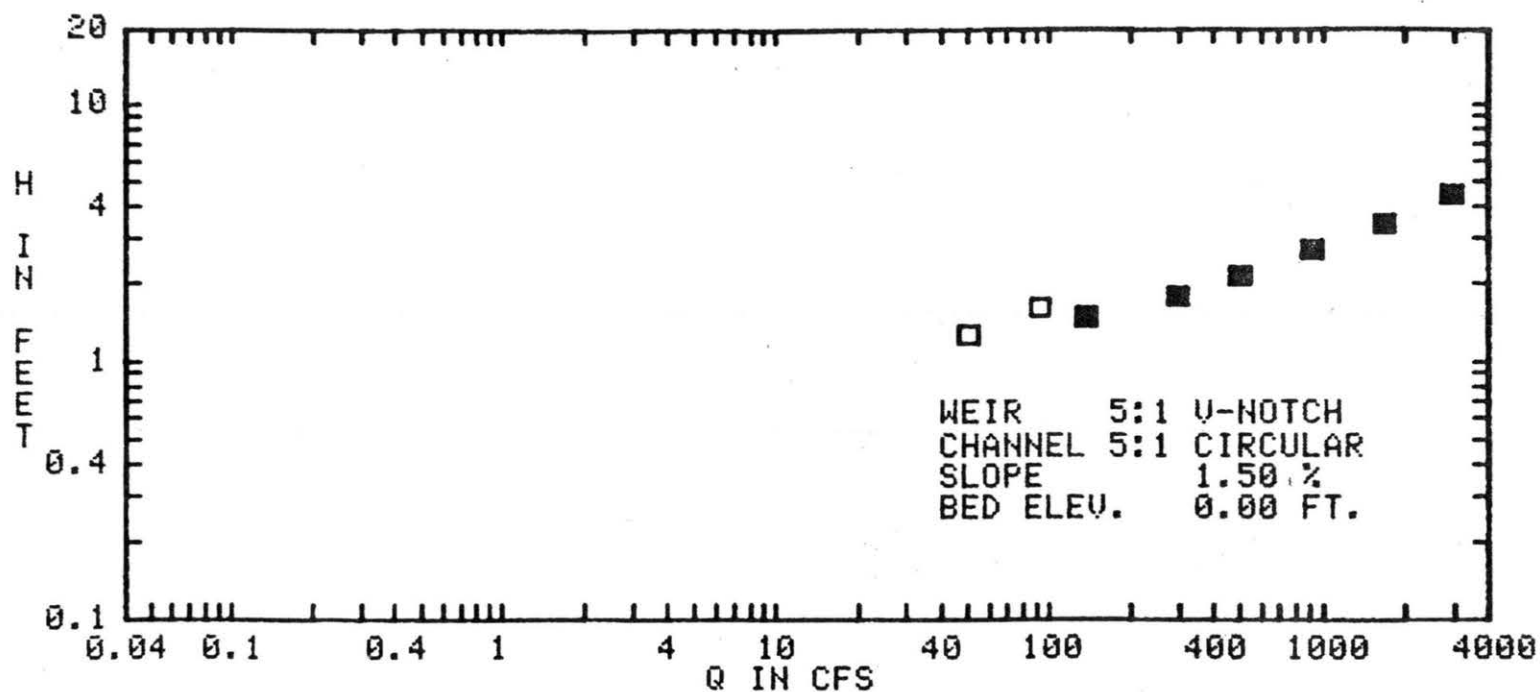

FIG. A-53 PLOT OF HEAD versus DISCHARGE DATA POINTS

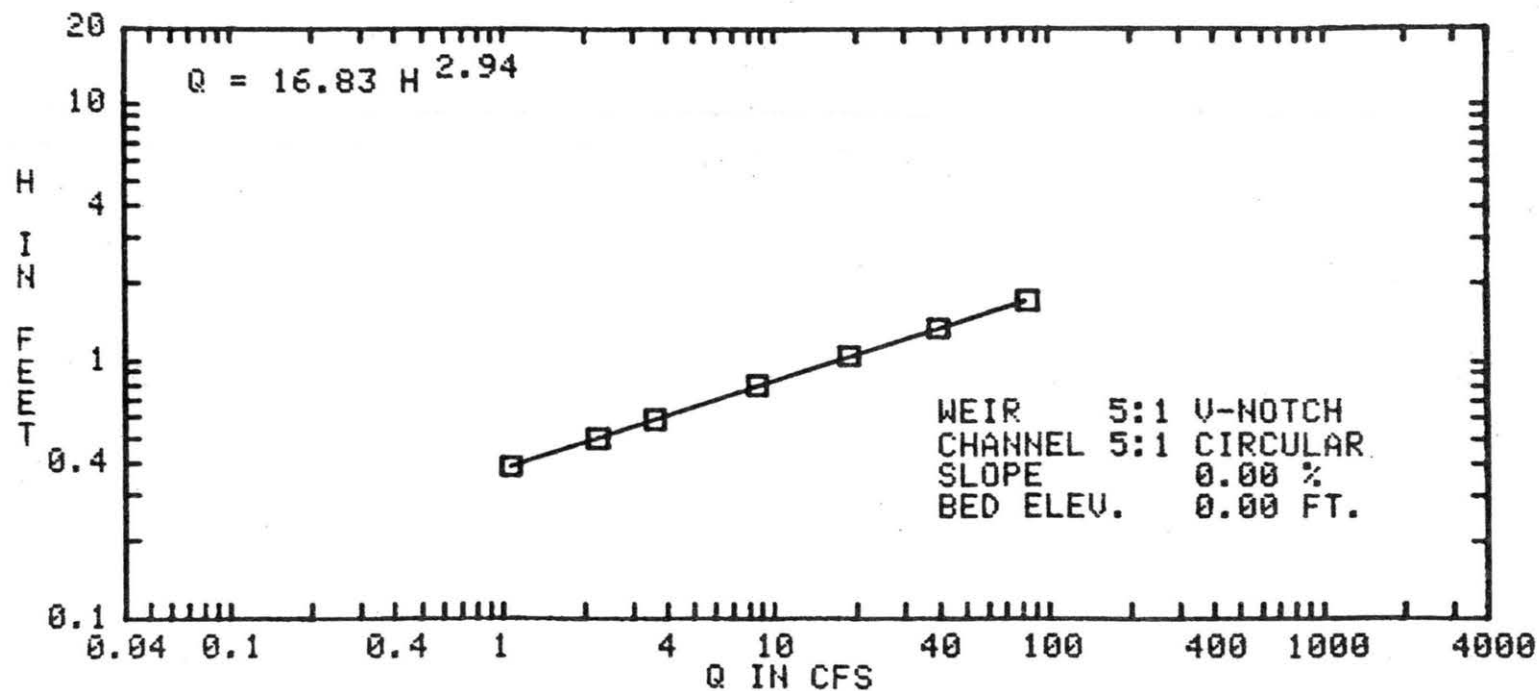

FIG. A-54 PLOT OF HEAD versus DISCHARGE DATA POINTS

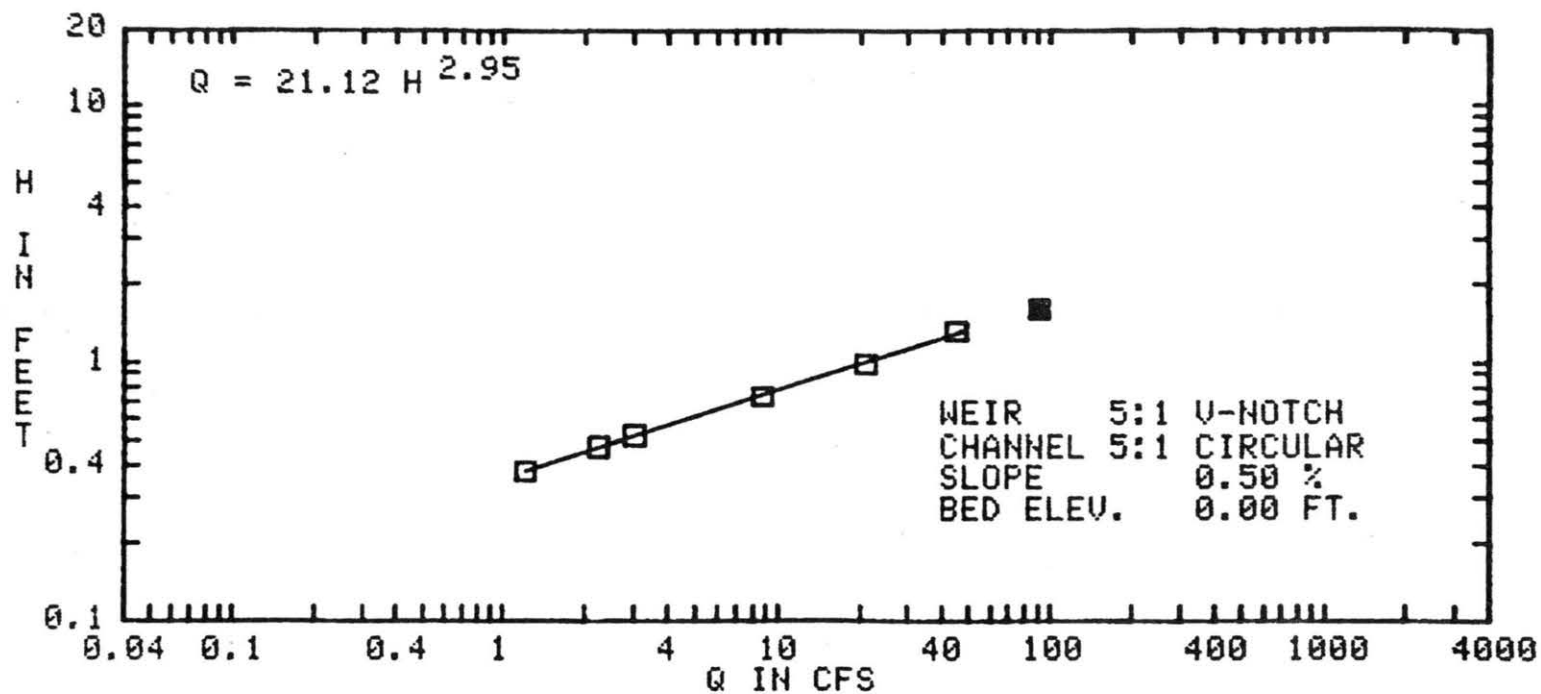

FIG. A-55 PLOT OF HEAD versus DISCHARGE DATA POINTS

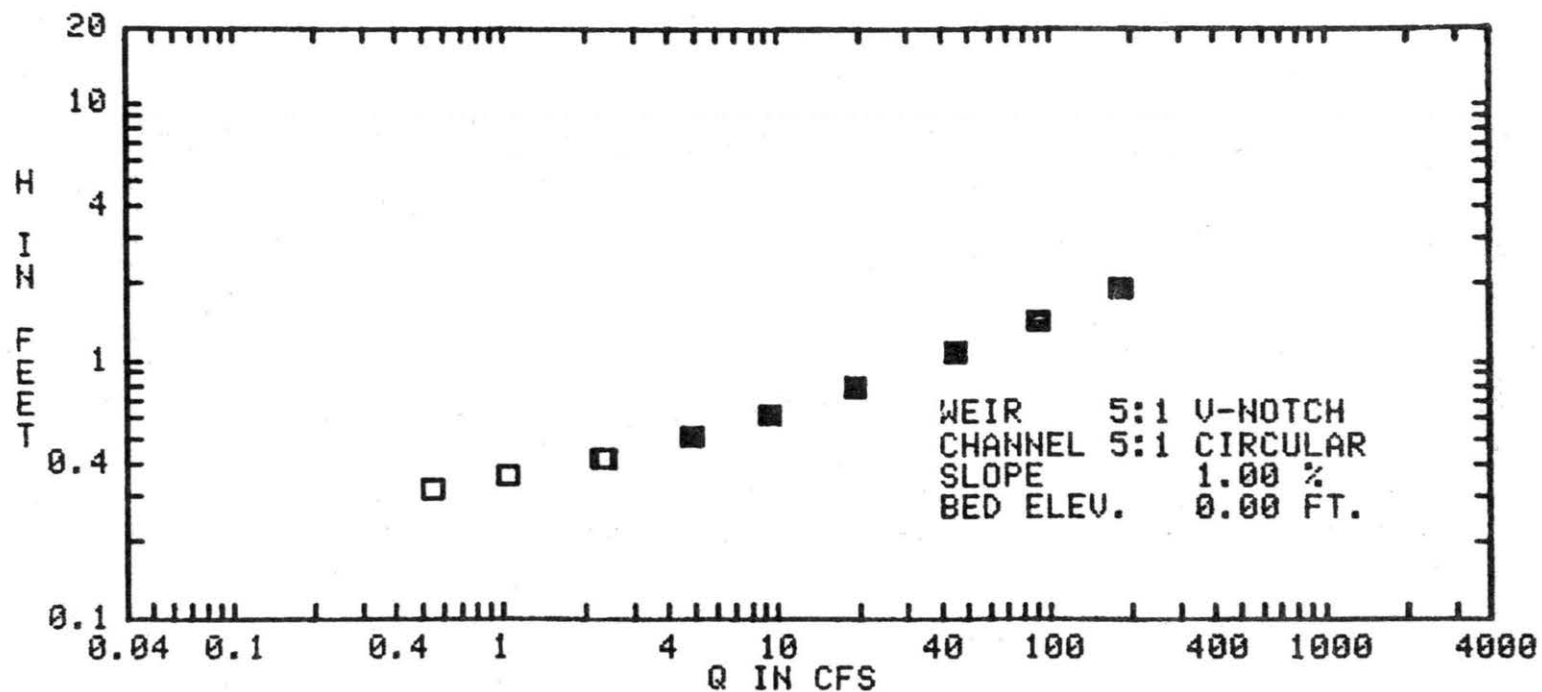

FIG. A-56 PLOT OF HEAD versus DISCHARGE DATA POINTS

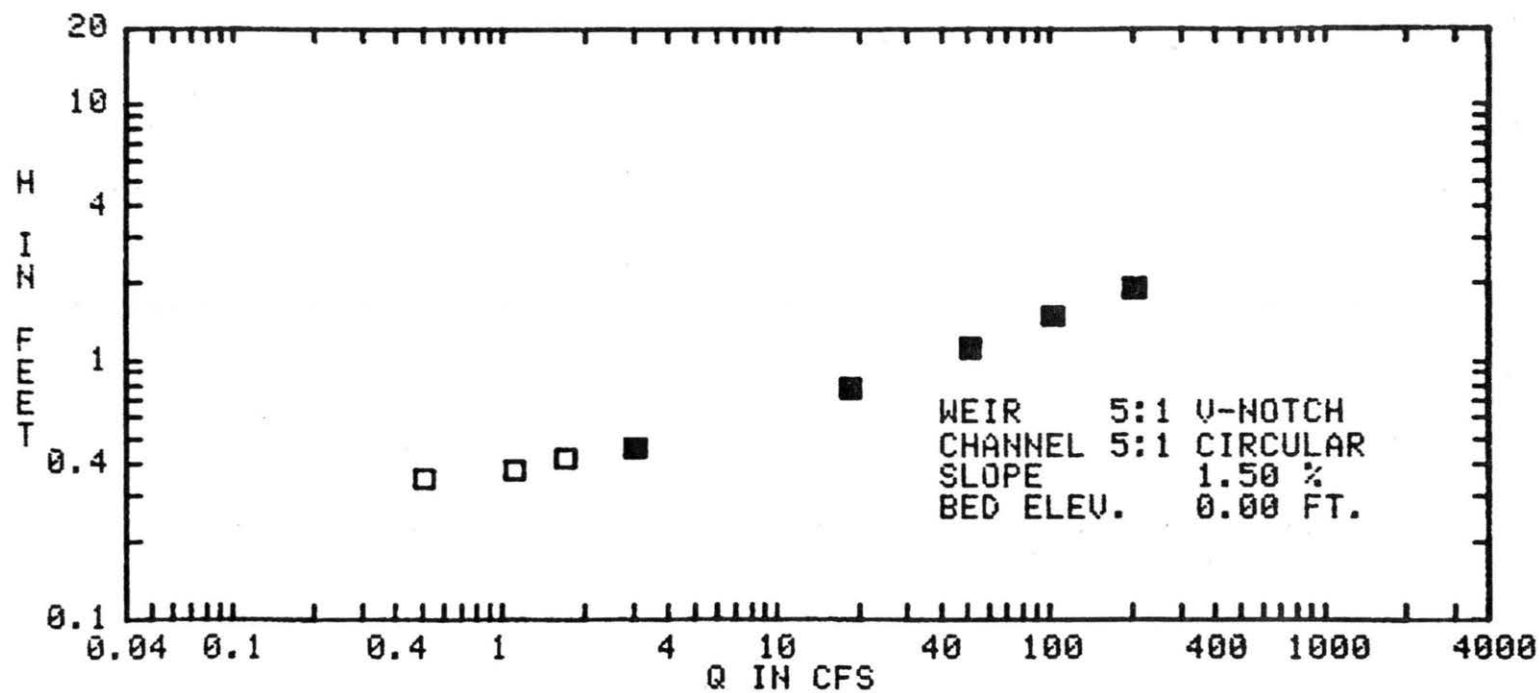

FIG. A-57 PLOT OF HEAD versus DISCHARGE DATA POINTS

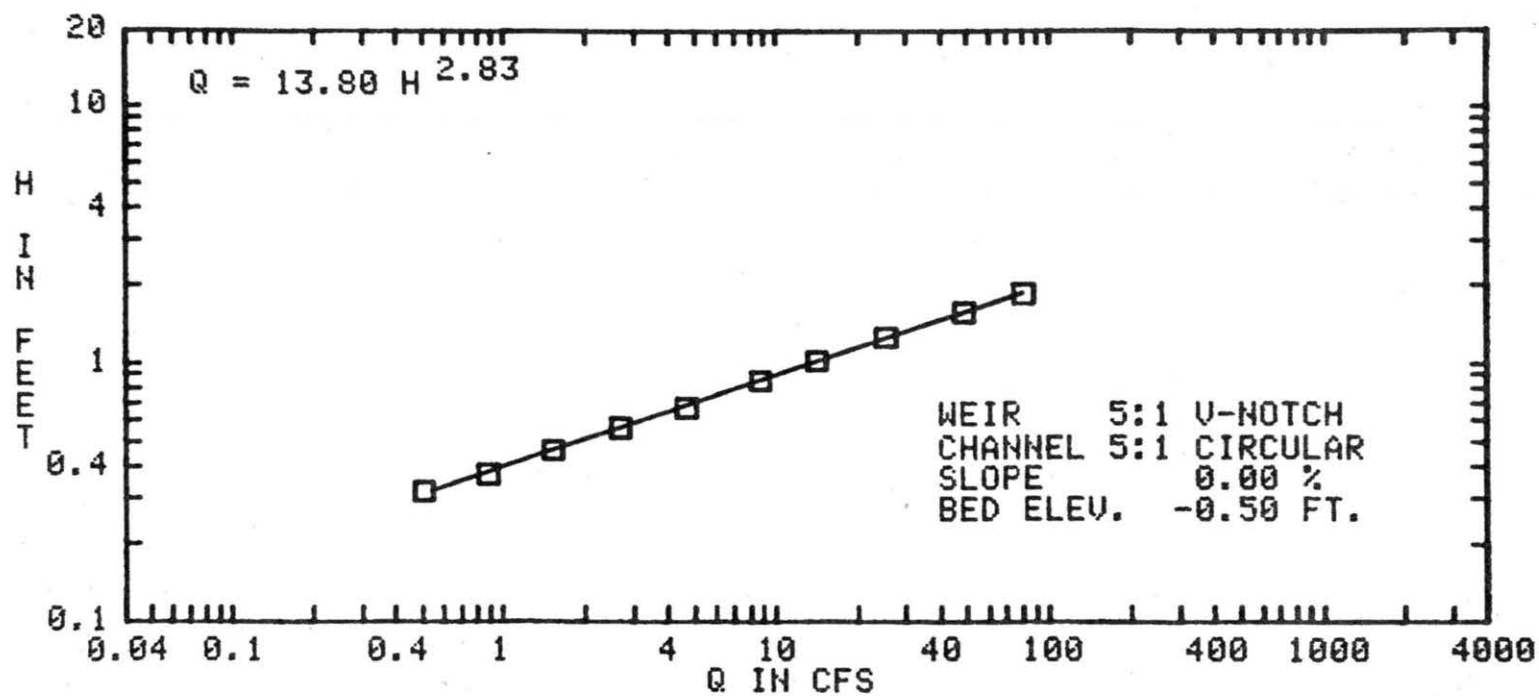

FIG. A-58 PLOT OF HEAD versus DISCHARGE DATA POINTS

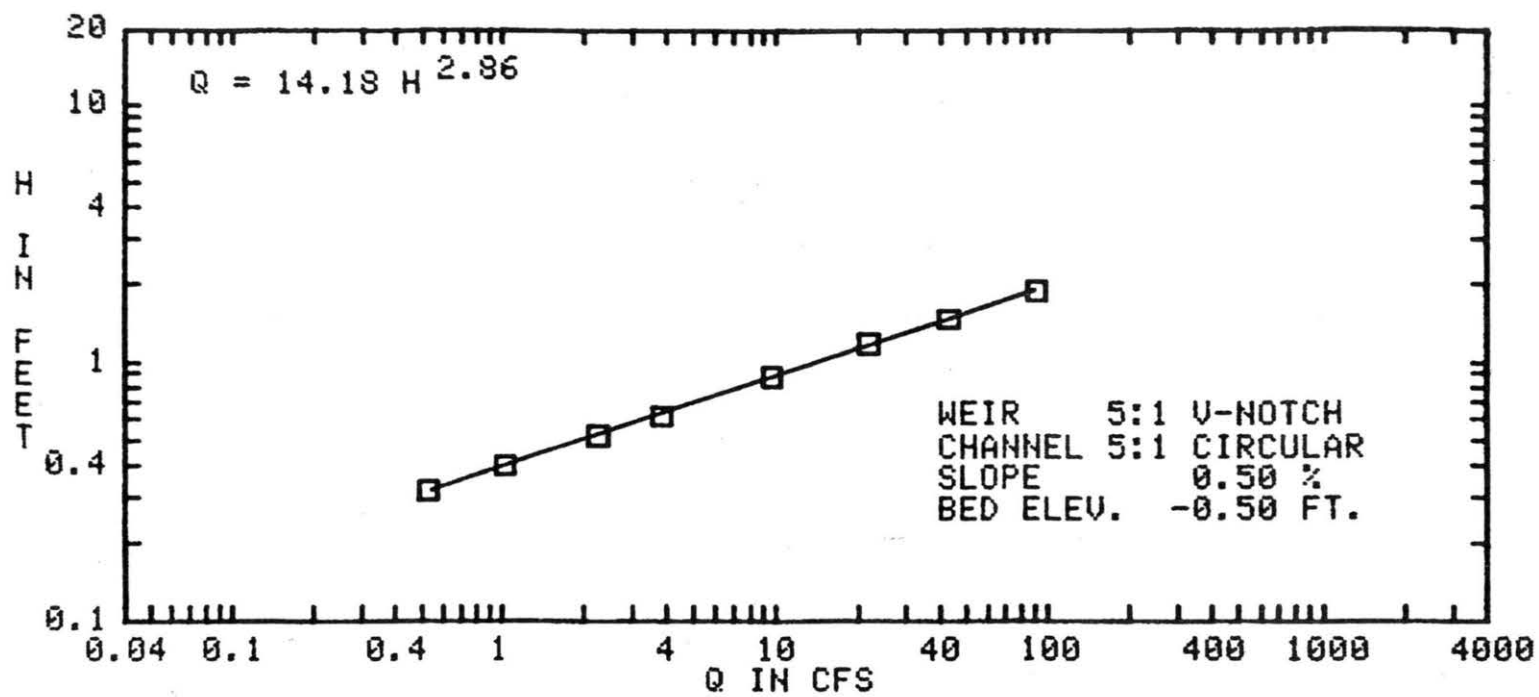

FIG. A-59 PLOT OF HEAD versus DISCHARGE DATA POINTS

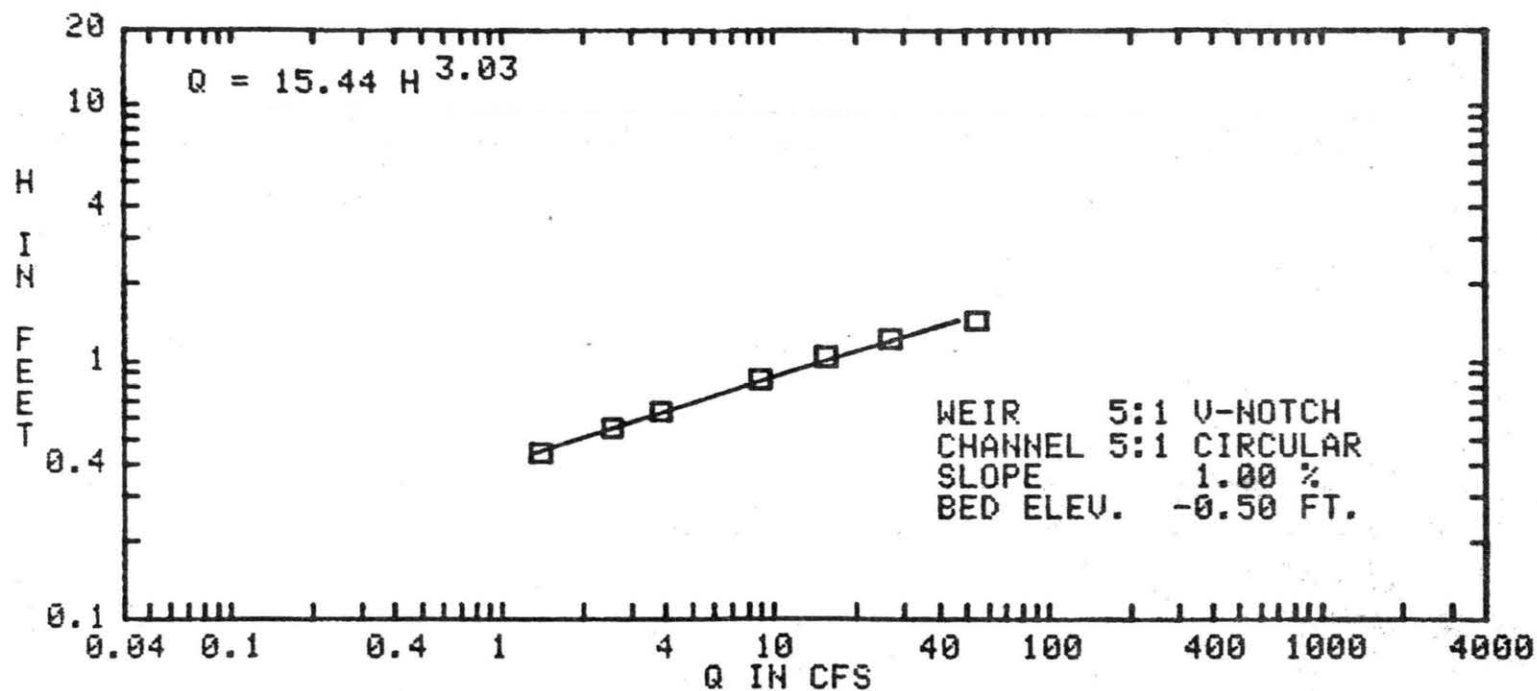

FIG. A-60 PLOT OF HEAD versus DISCHARGE DATA POINTS

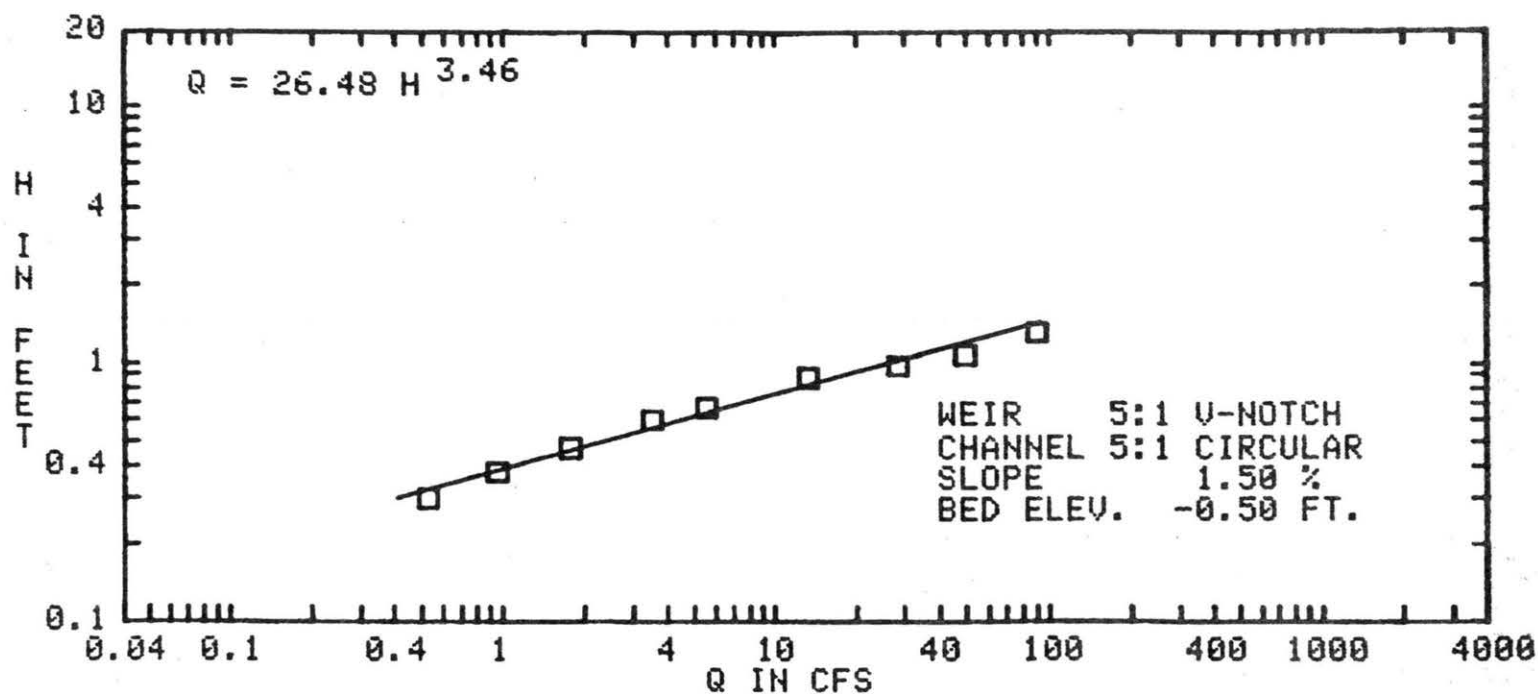

FIG. A-61 PLOT OF HEAD versus DISCHARGE DATA POINTS

Appendix B

INDIVIDUAL TOTAL HEAD VS DISCHARGE
DATA PLOTS

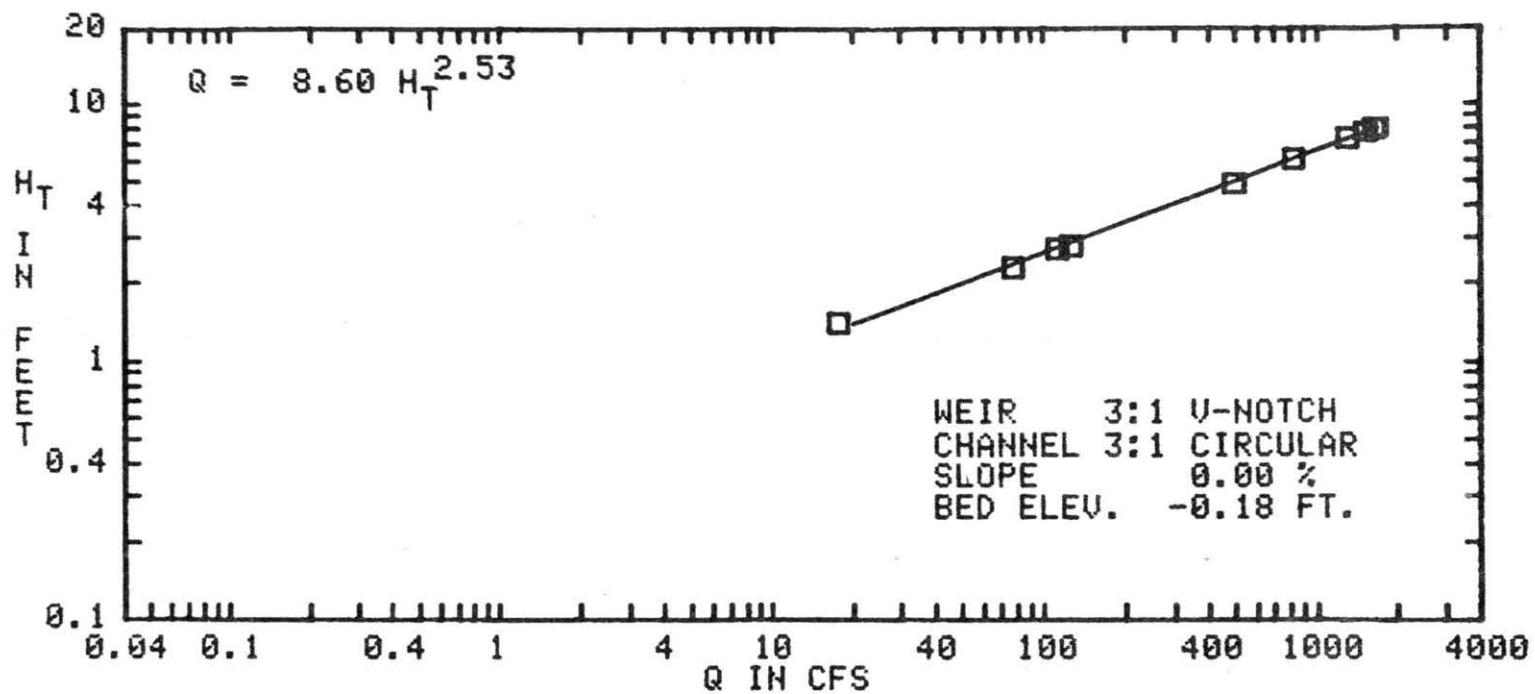

FIG. B-1 PLOT OF TOTAL HEAD versus DISCHARGE DATA POINTS

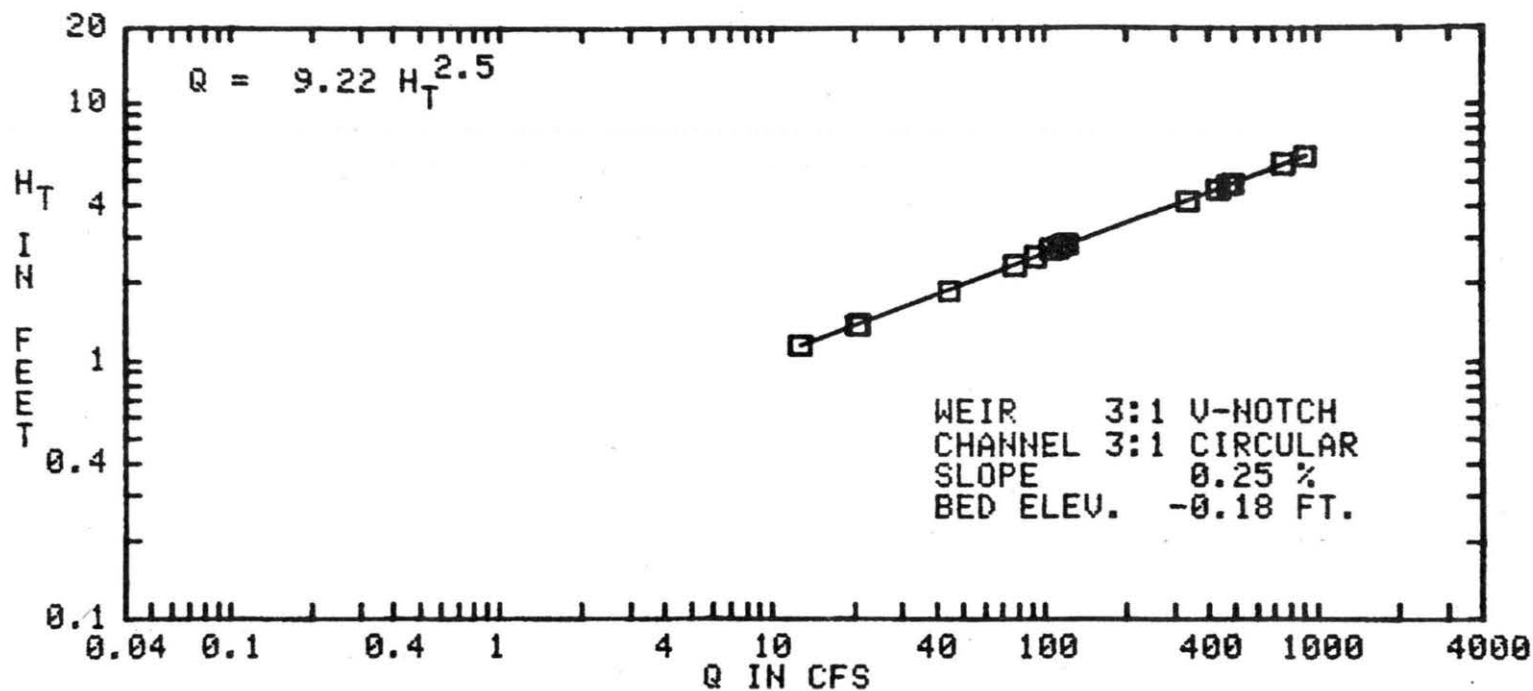

FIG. B-2 PLOT OF TOTAL HEAD versus DISCHARGE DATA POINTS

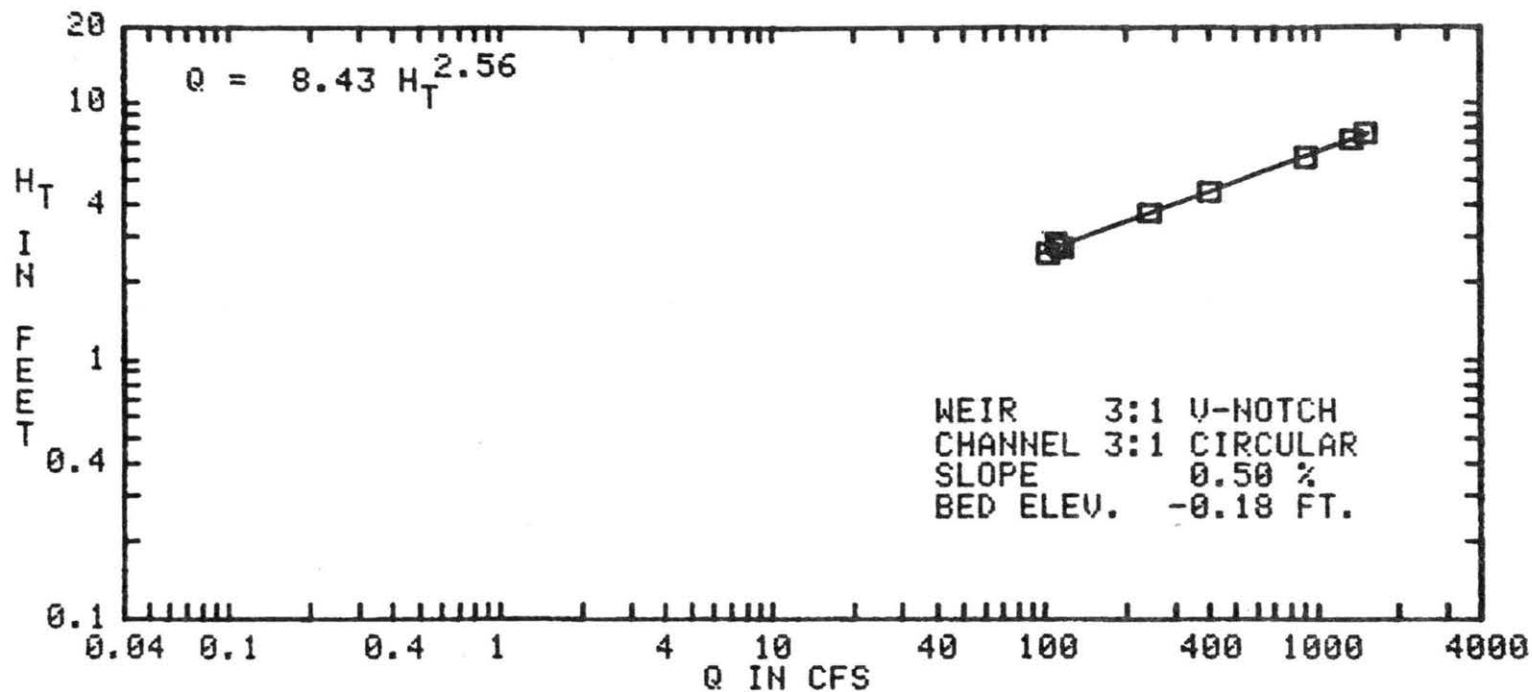

FIG. B-3 PLOT OF TOTAL HEAD versus DISCHARGE DATA POINTS

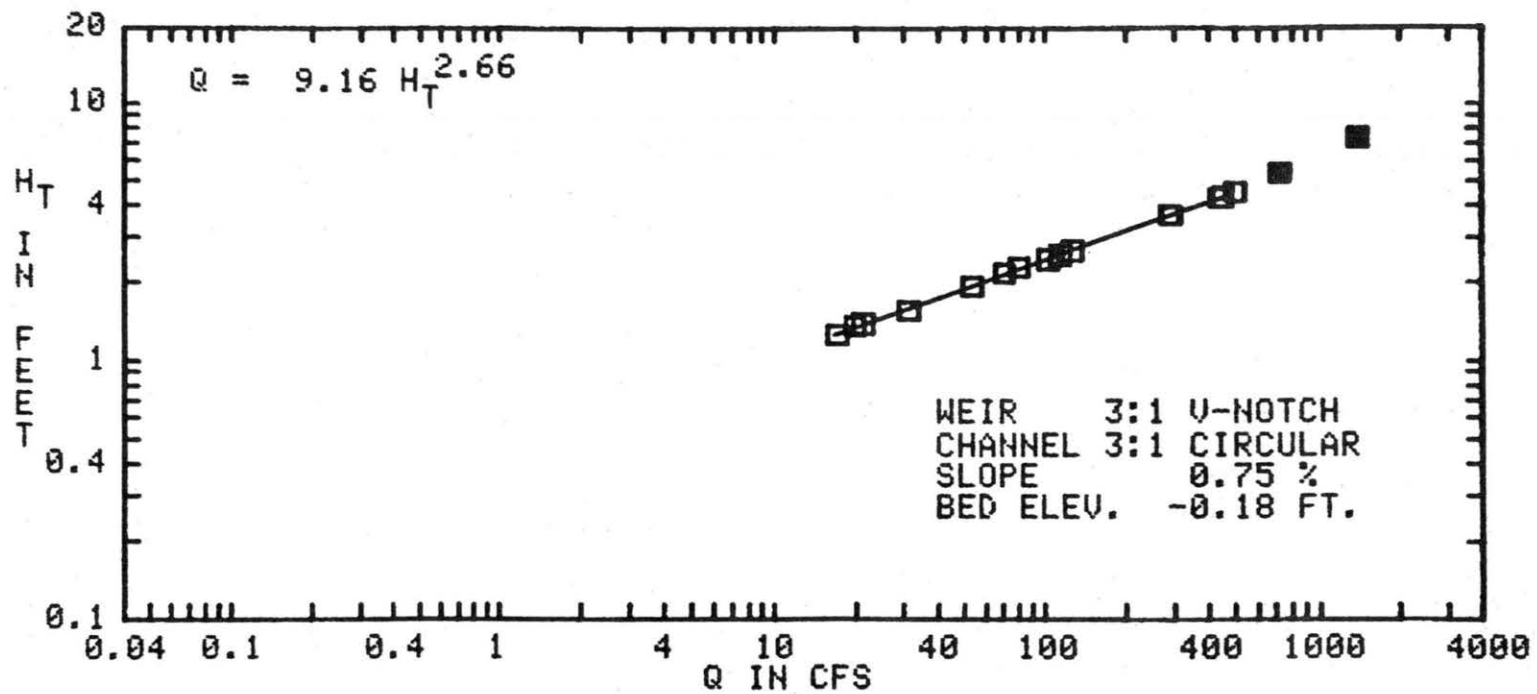

FIG. B-4 PLOT OF TOTAL HEAD versus DISCHARGE DATA POINTS

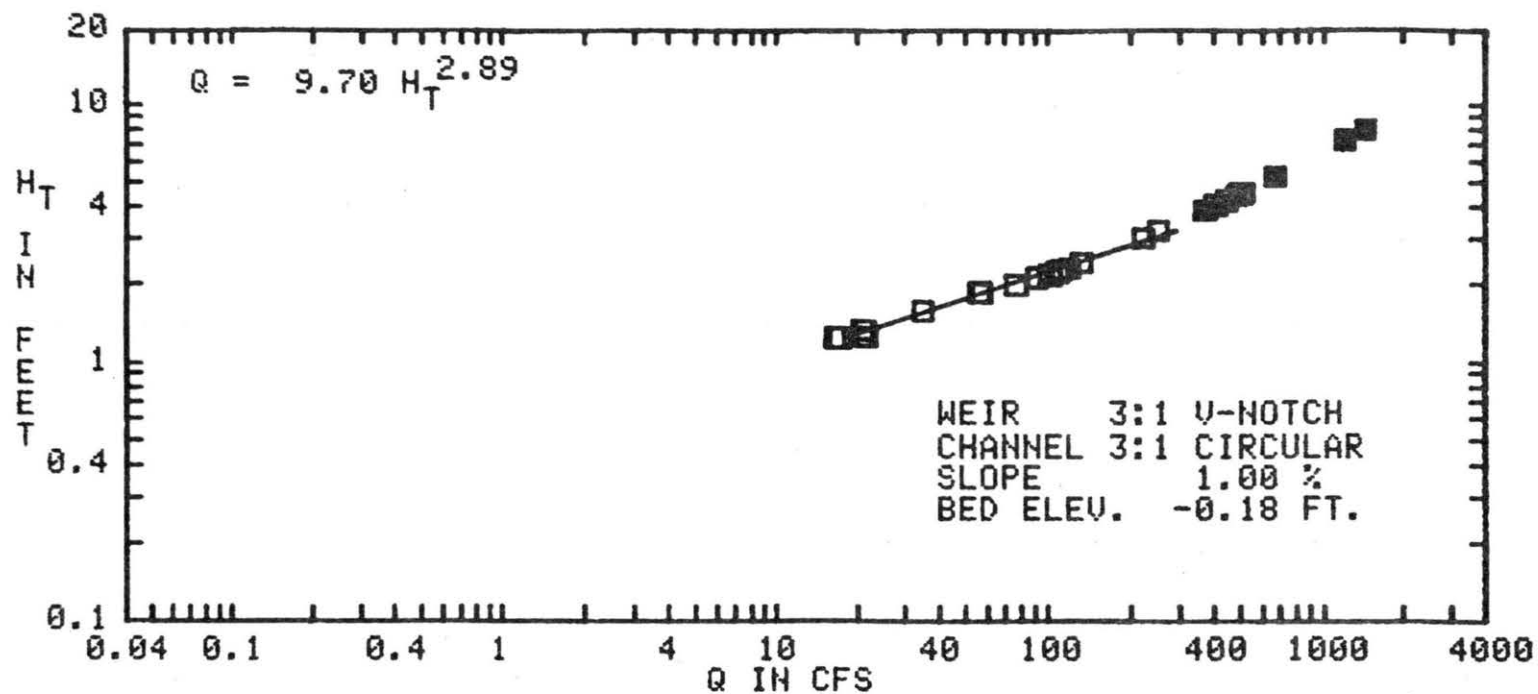

FIG. B-5 PLOT OF TOTAL HEAD versus DISCHARGE DATA POINTS

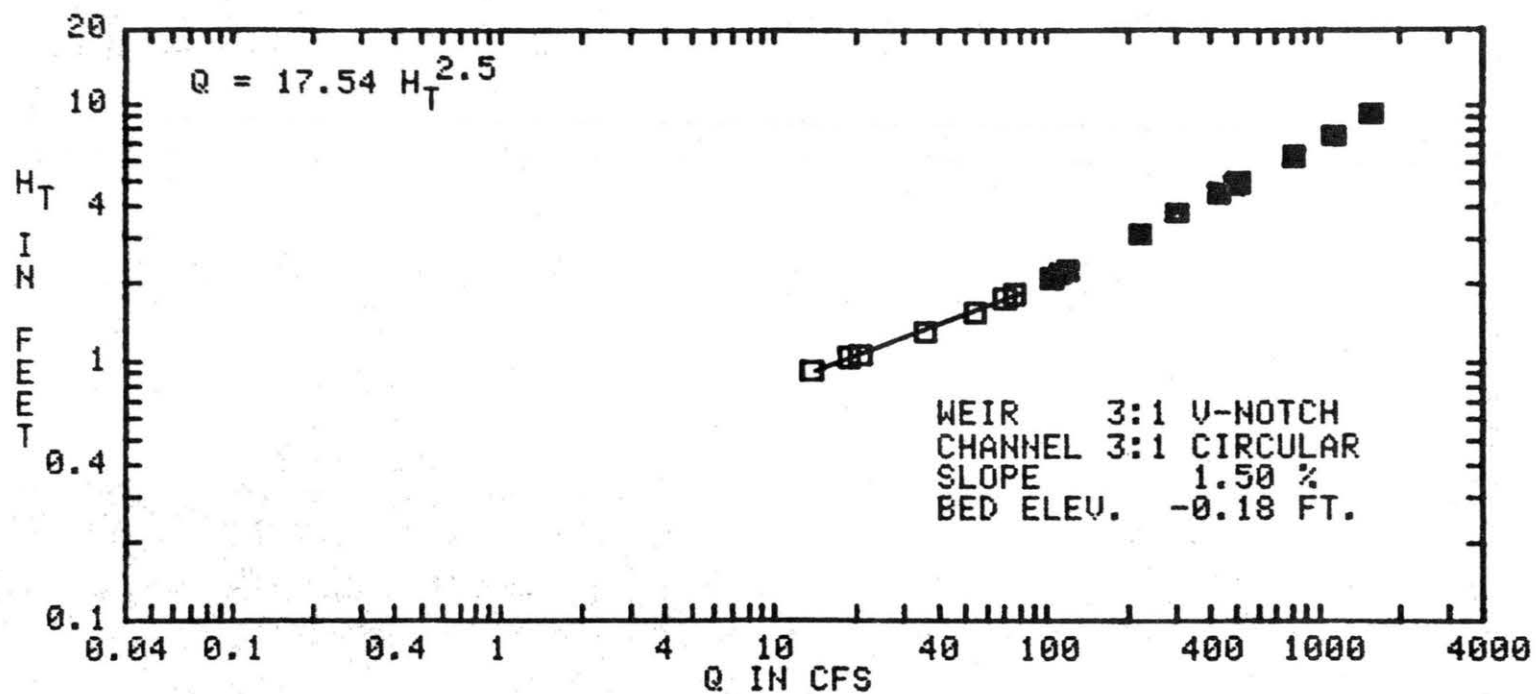

FIG. B-6 PLOT OF TOTAL HEAD versus DISCHARGE DATA POINTS

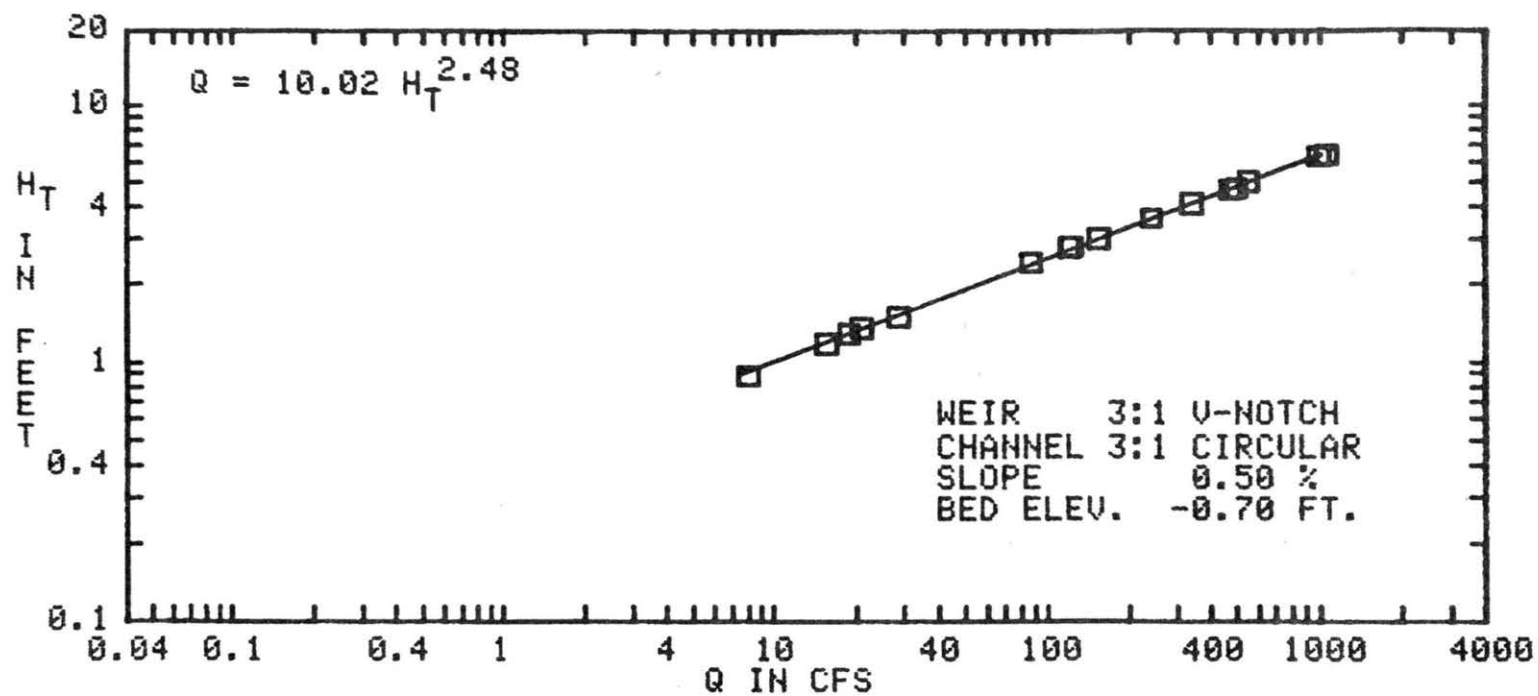

FIG. B-7 PLOT OF TOTAL HEAD versus DISCHARGE DATA POINTS

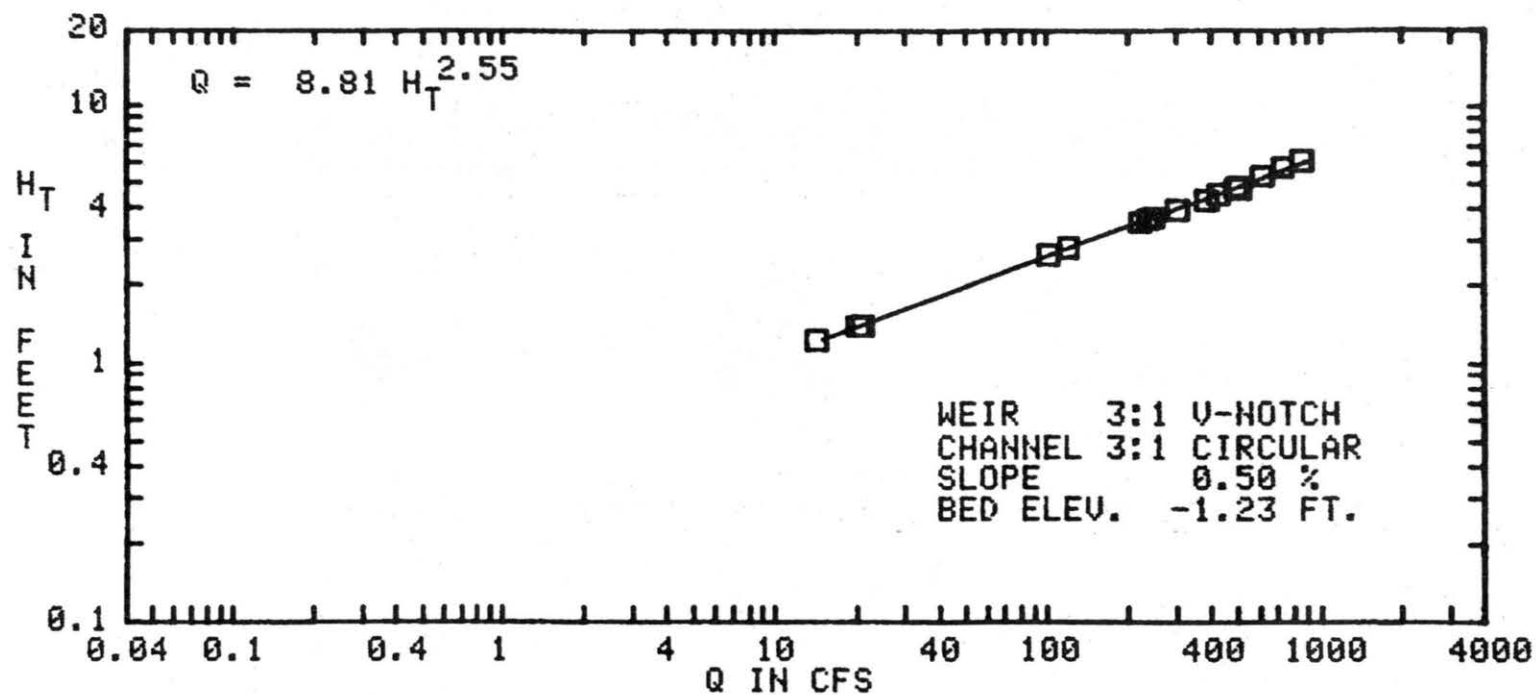

FIG. B-8 PLOT OF TOTAL HEAD versus DISCHARGE DATA POINTS

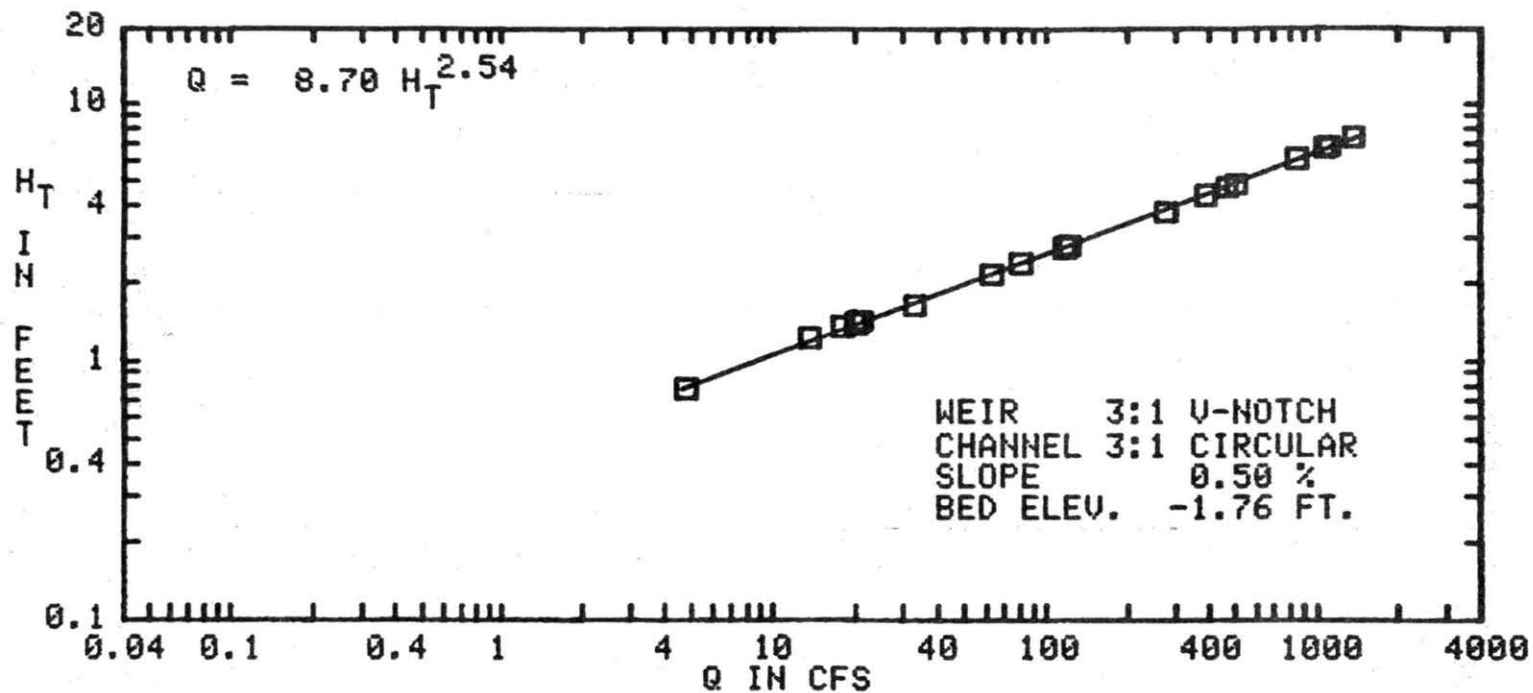

FIG. B-9 PLOT OF TOTAL HEAD versus DISCHARGE DATA POINTS

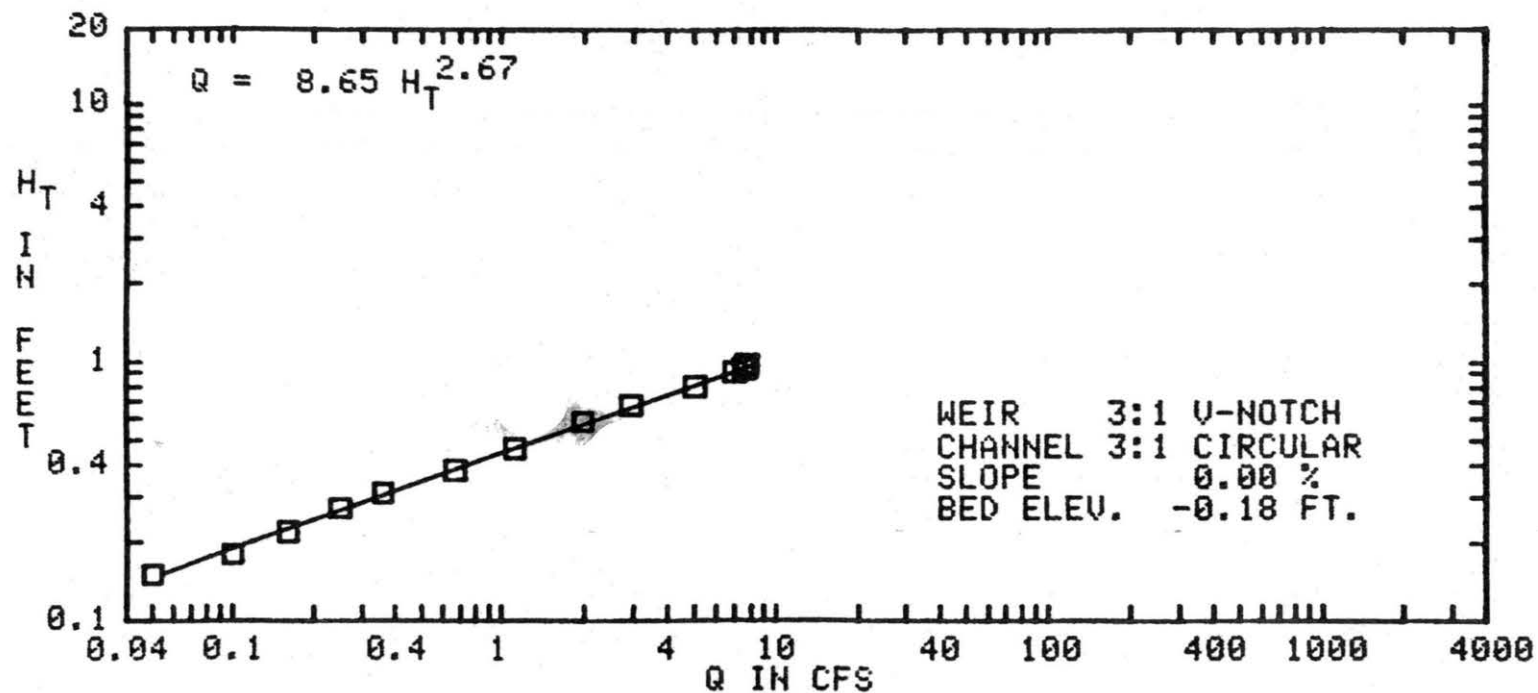

FIG. B-10 PLOT OF TOTAL HEAD versus DISCHARGE DATA POINTS

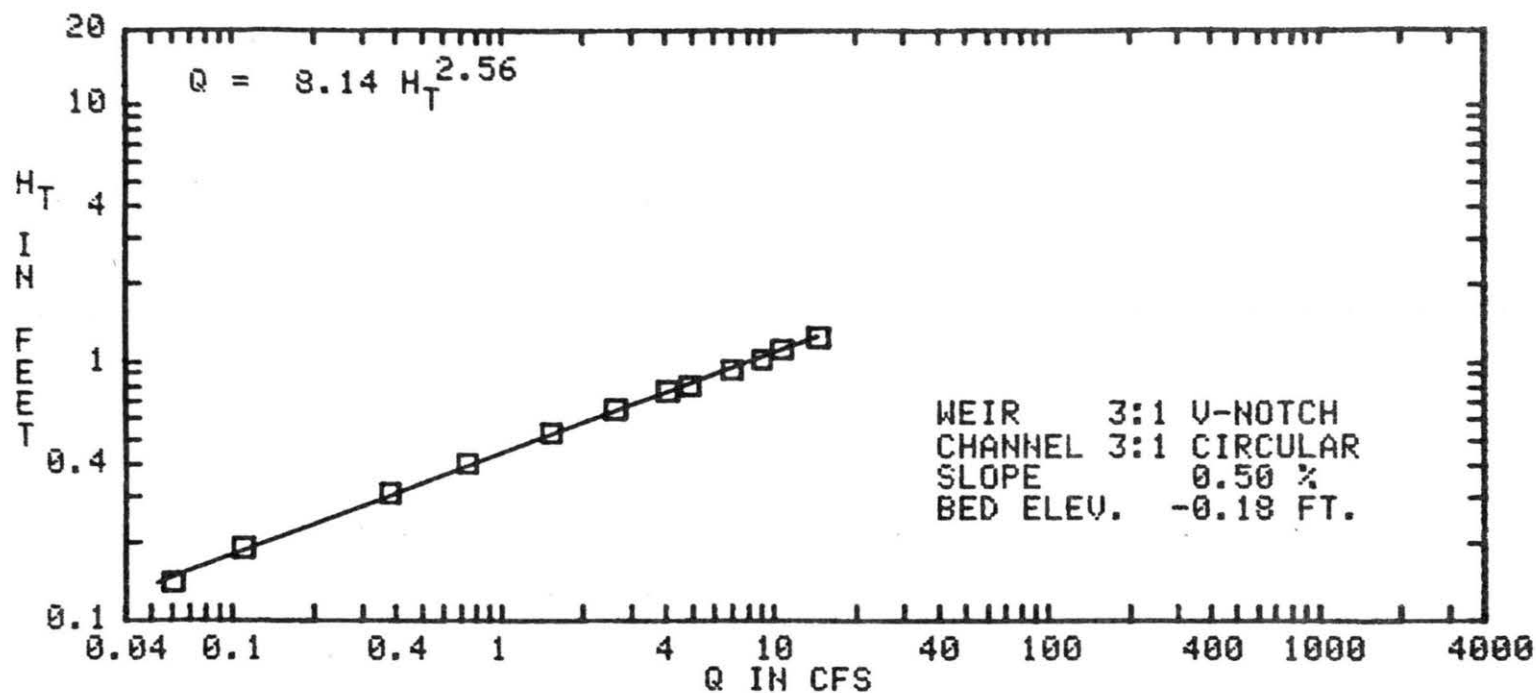

FIG. B-11 PLOT OF TOTAL HEAD versus DISCHARGE DATA POINTS

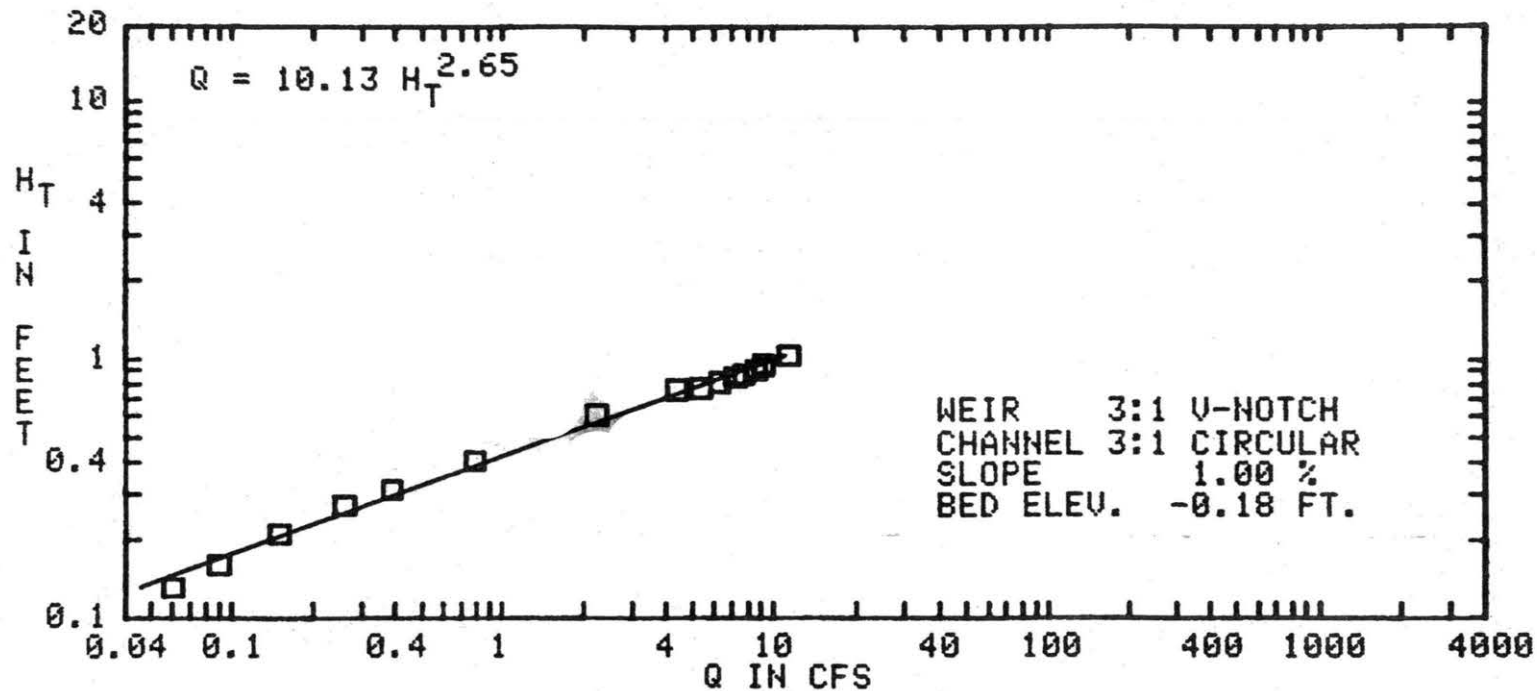

FIG. B-12 PLOT OF TOTAL HEAD versus DISCHARGE DATA POINTS

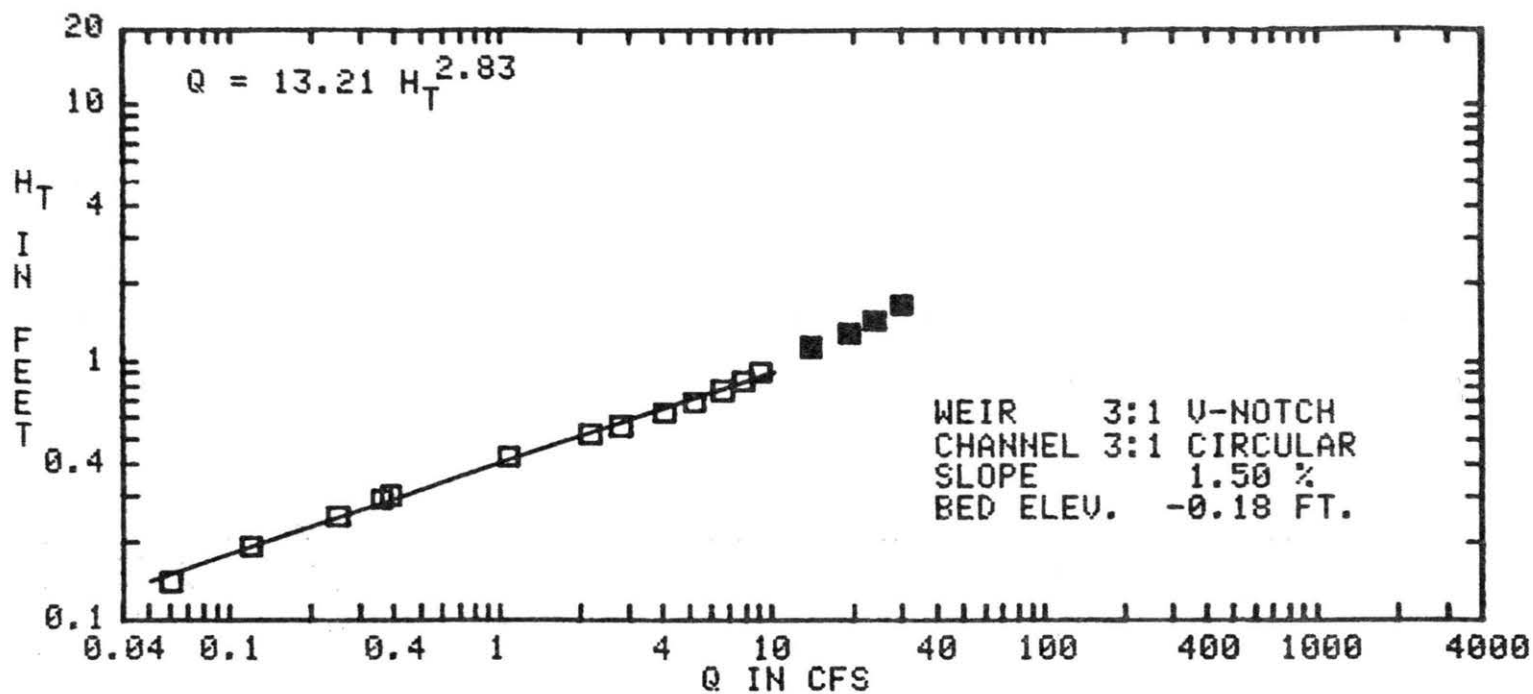

FIG. B-13 PLOT OF TOTAL HEAD versus DISCHARGE DATA POINTS

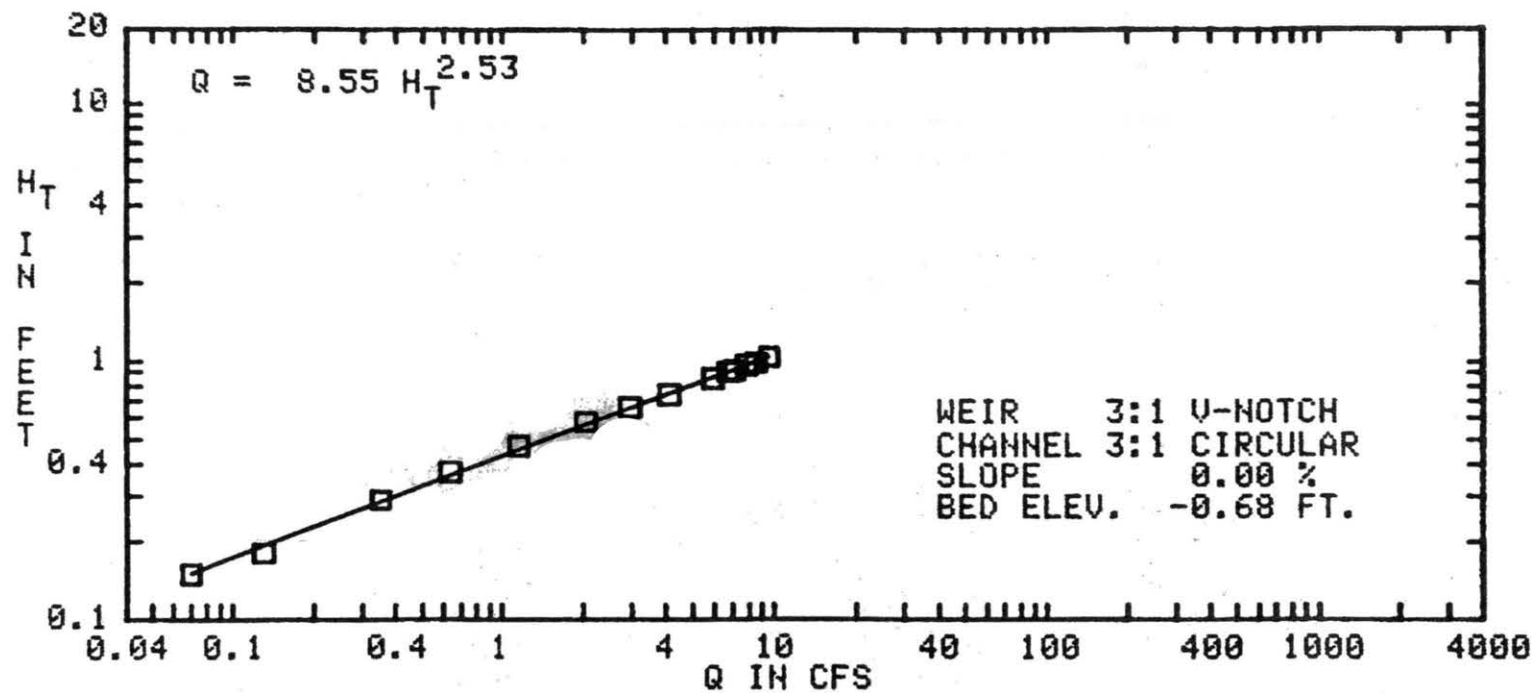

FIG. B-14 PLOT OF TOTAL HEAD versus DISCHARGE DATA POINTS

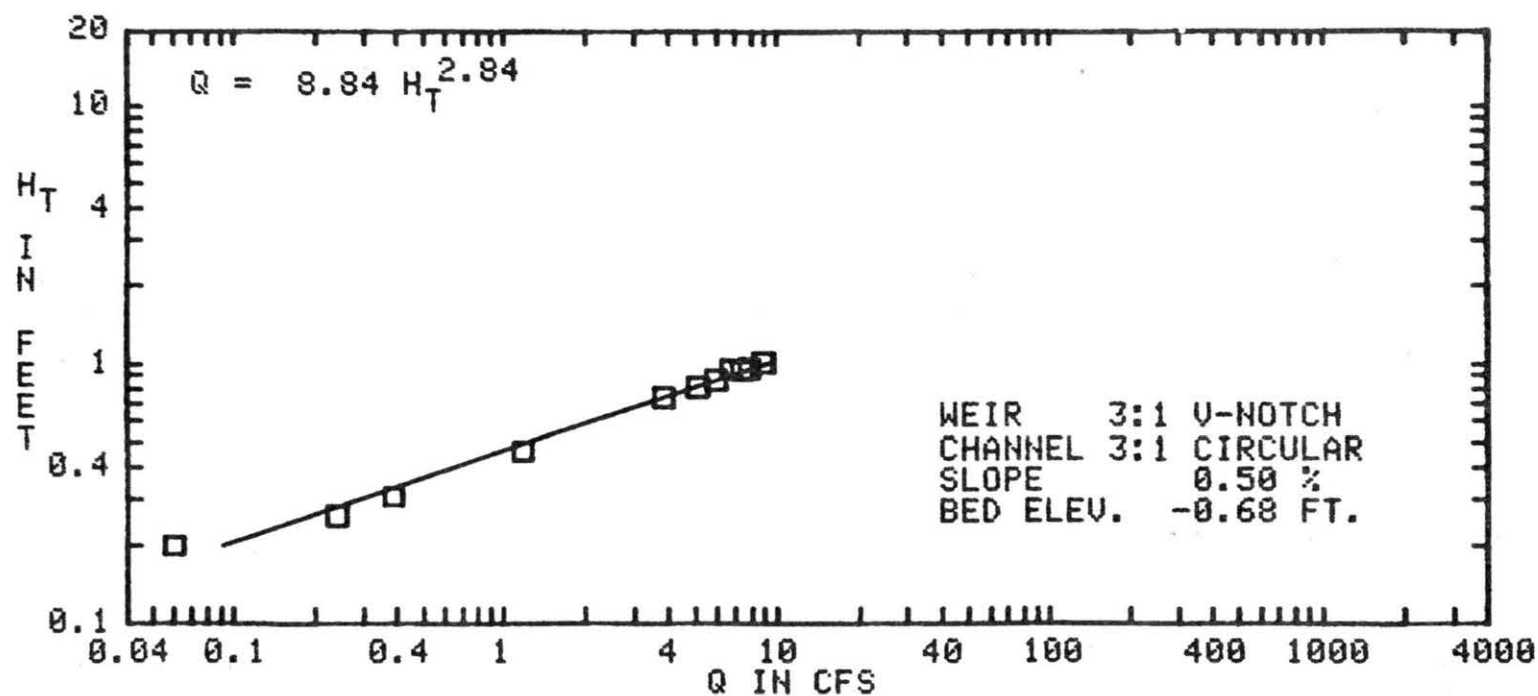

FIG. B-15 PLOT OF TOTAL HEAD versus DISCHARGE DATA POINTS

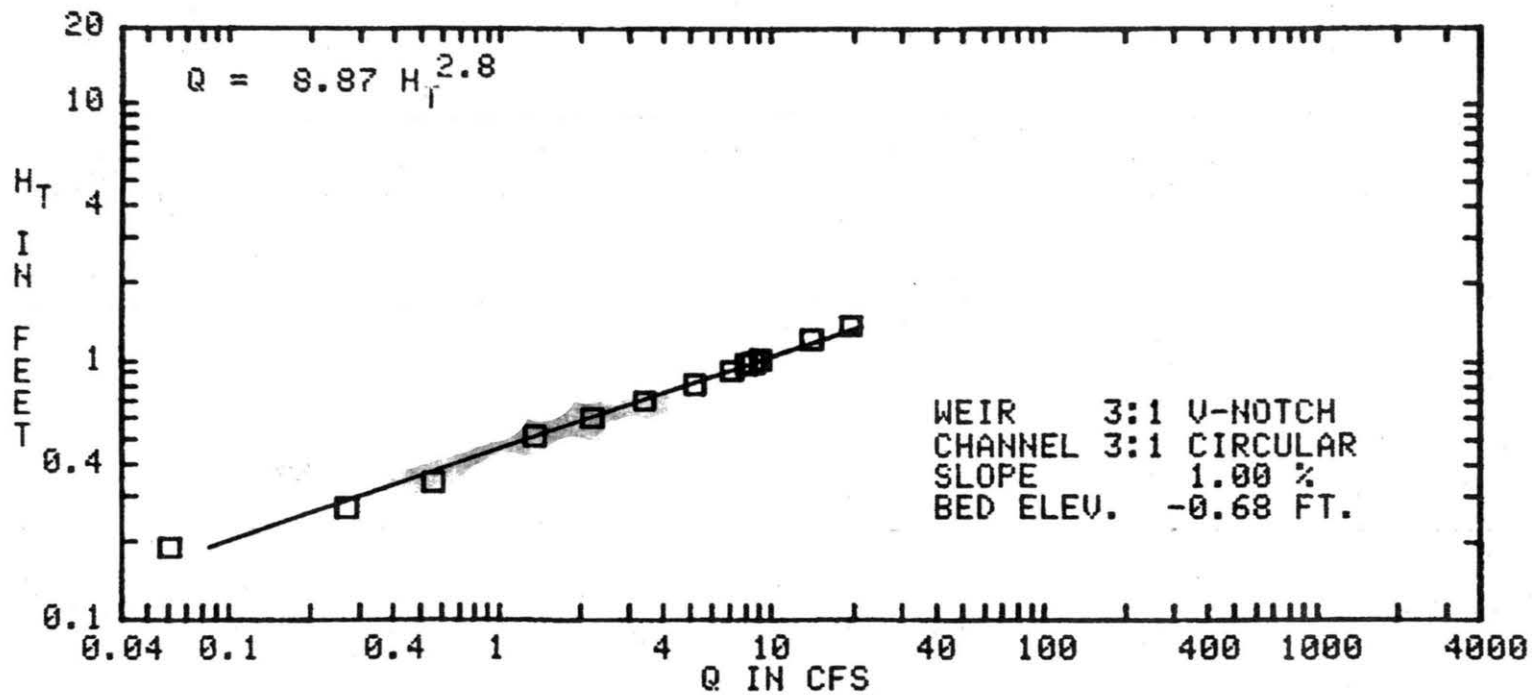

FIG. B-16 PLOT OF TOTAL HEAD versus DISCHARGE DATA POINTS

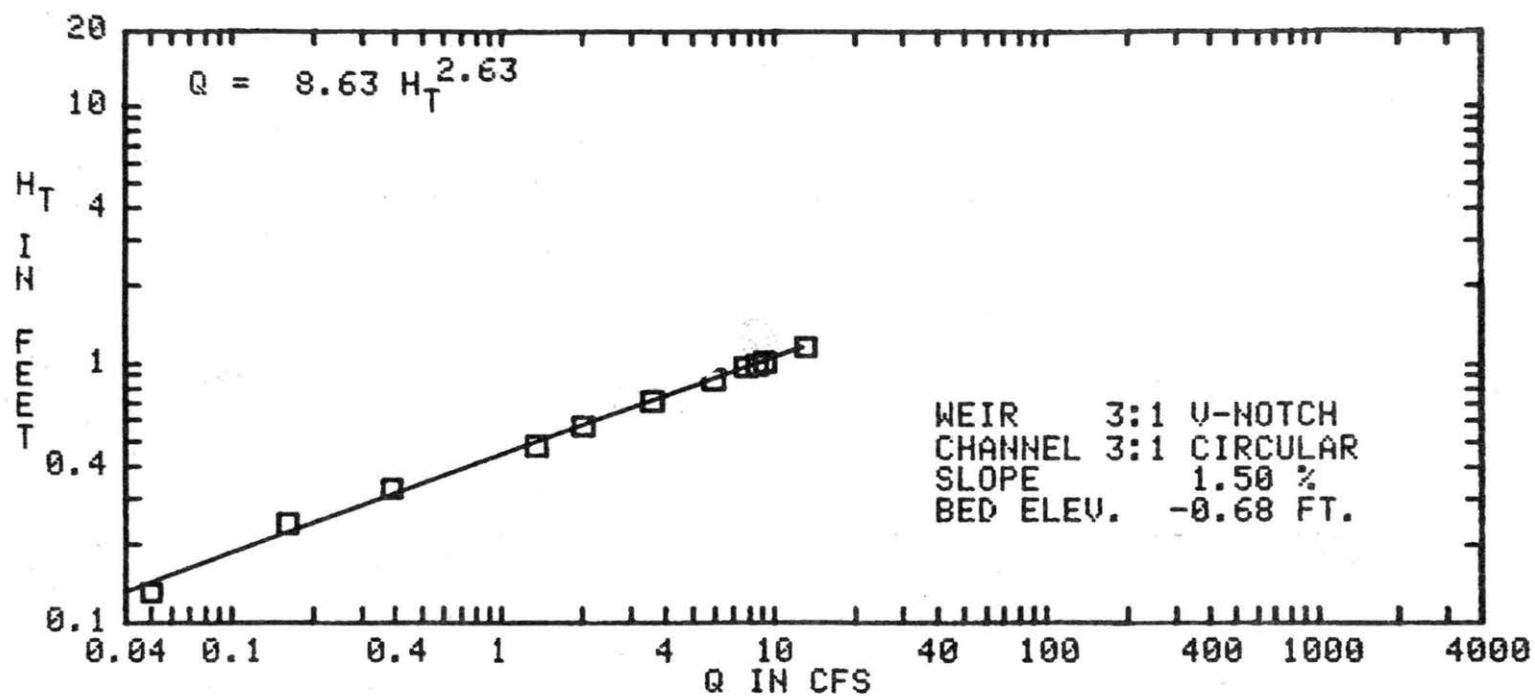

FIG. B-17 PLOT OF TOTAL HEAD versus DISCHARGE DATA POINTS

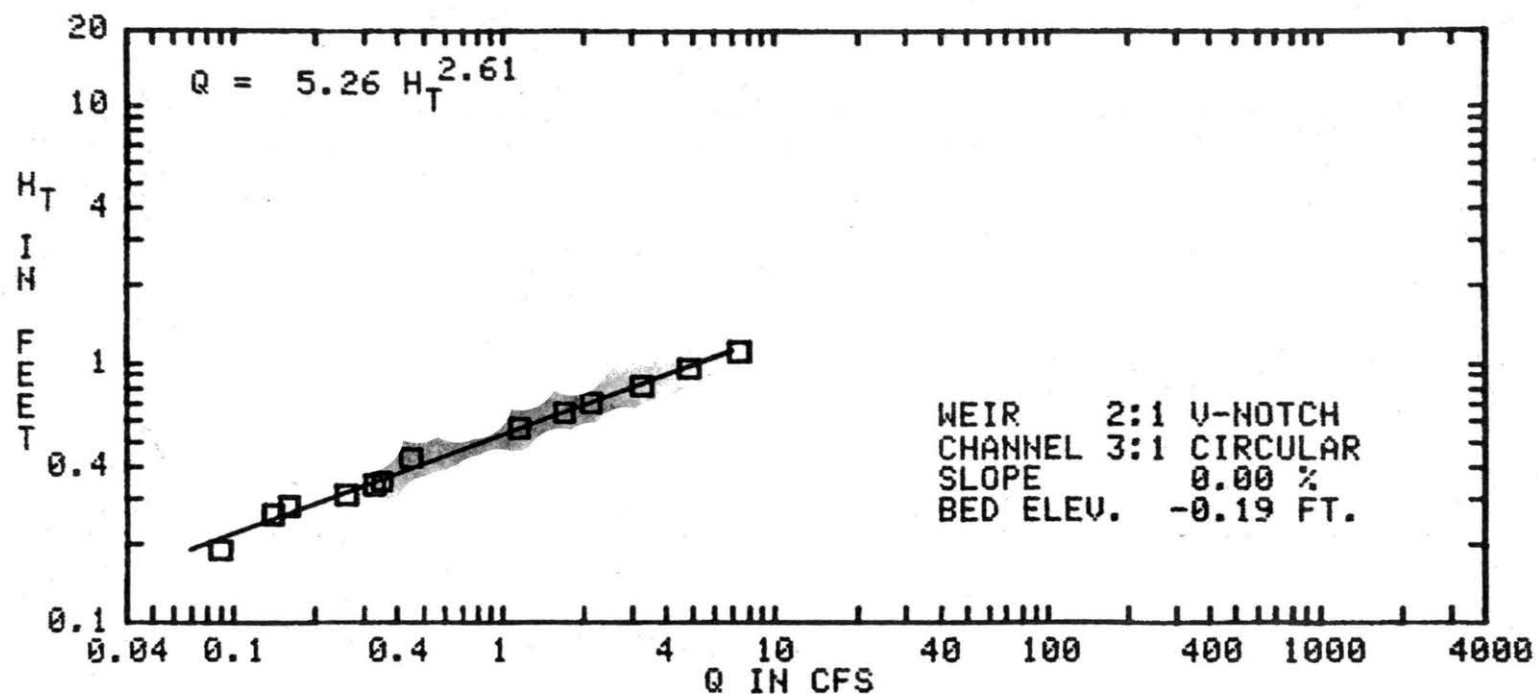

FIG. B-18 PLOT OF TOTAL HEAD versus DISCHARGE DATA POINTS

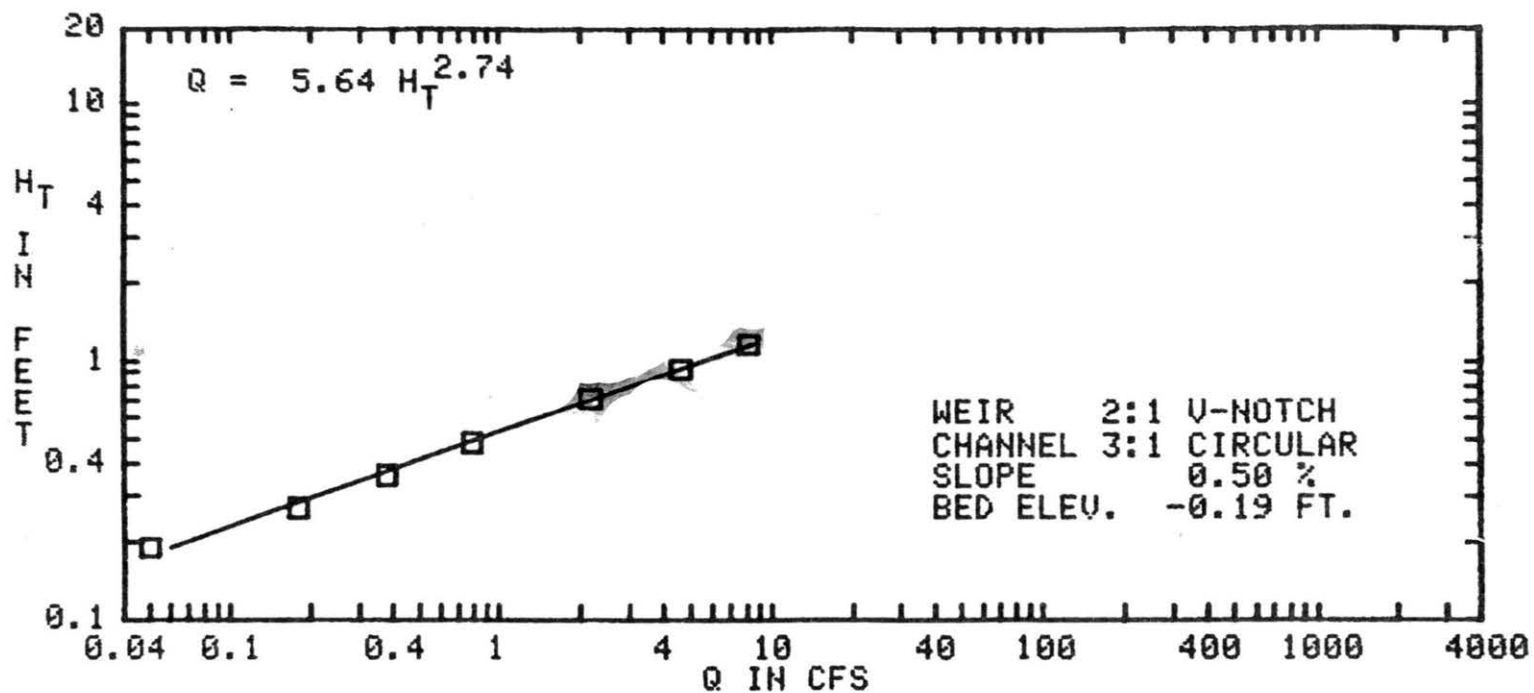

FIG. B-19 PLOT OF TOTAL HEAD versus DISCHARGE DATA POINTS

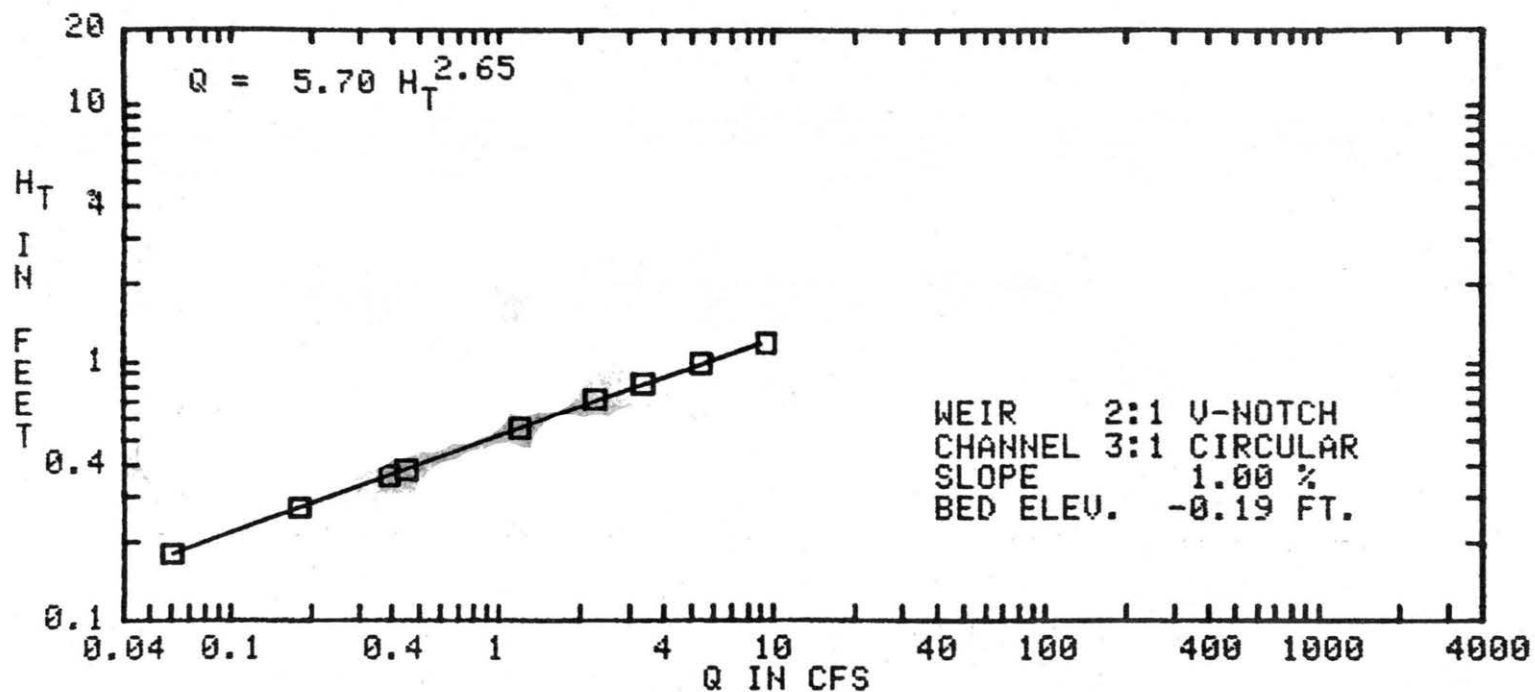

FIG. B-20 PLOT OF TOTAL HEAD versus DISCHARGE DATA POINTS

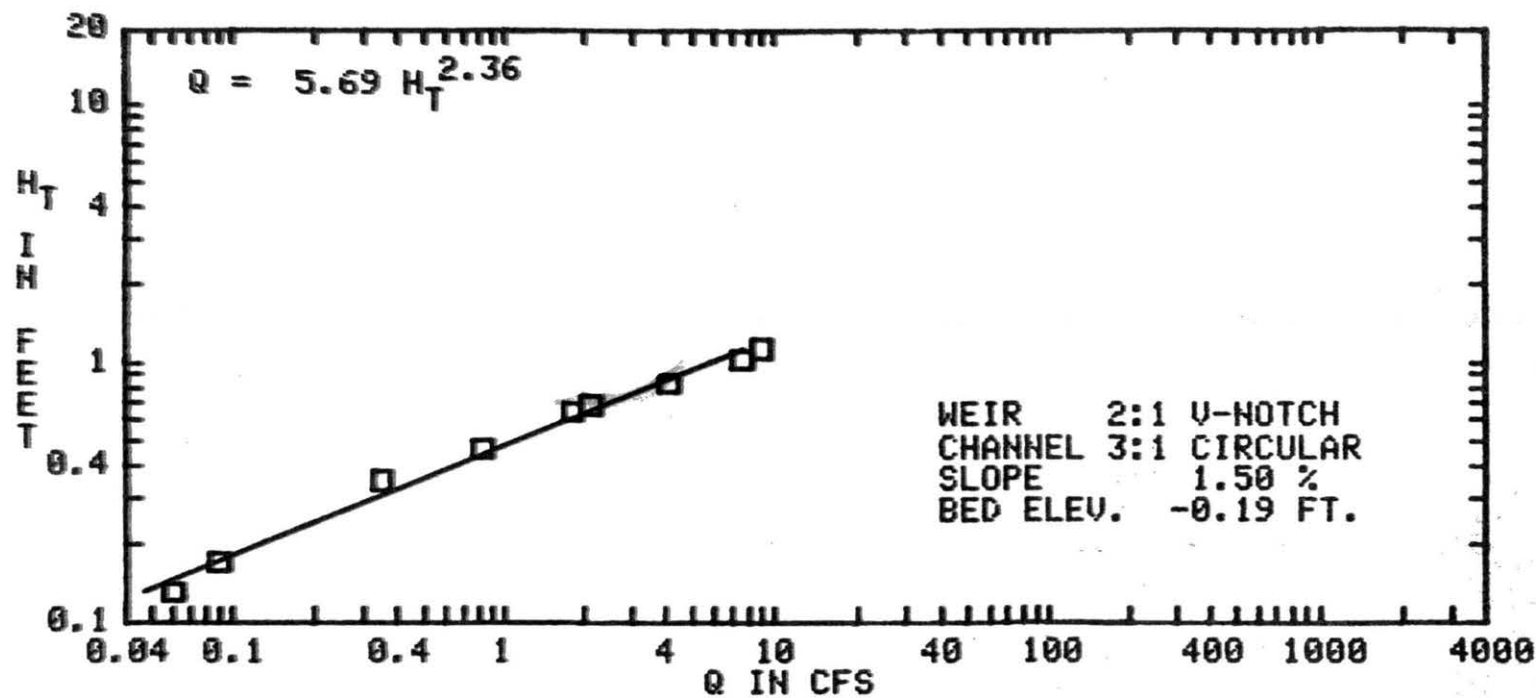

FIG. B-21 PLOT OF TOTAL HEAD versus DISCHARGE DATA POINTS

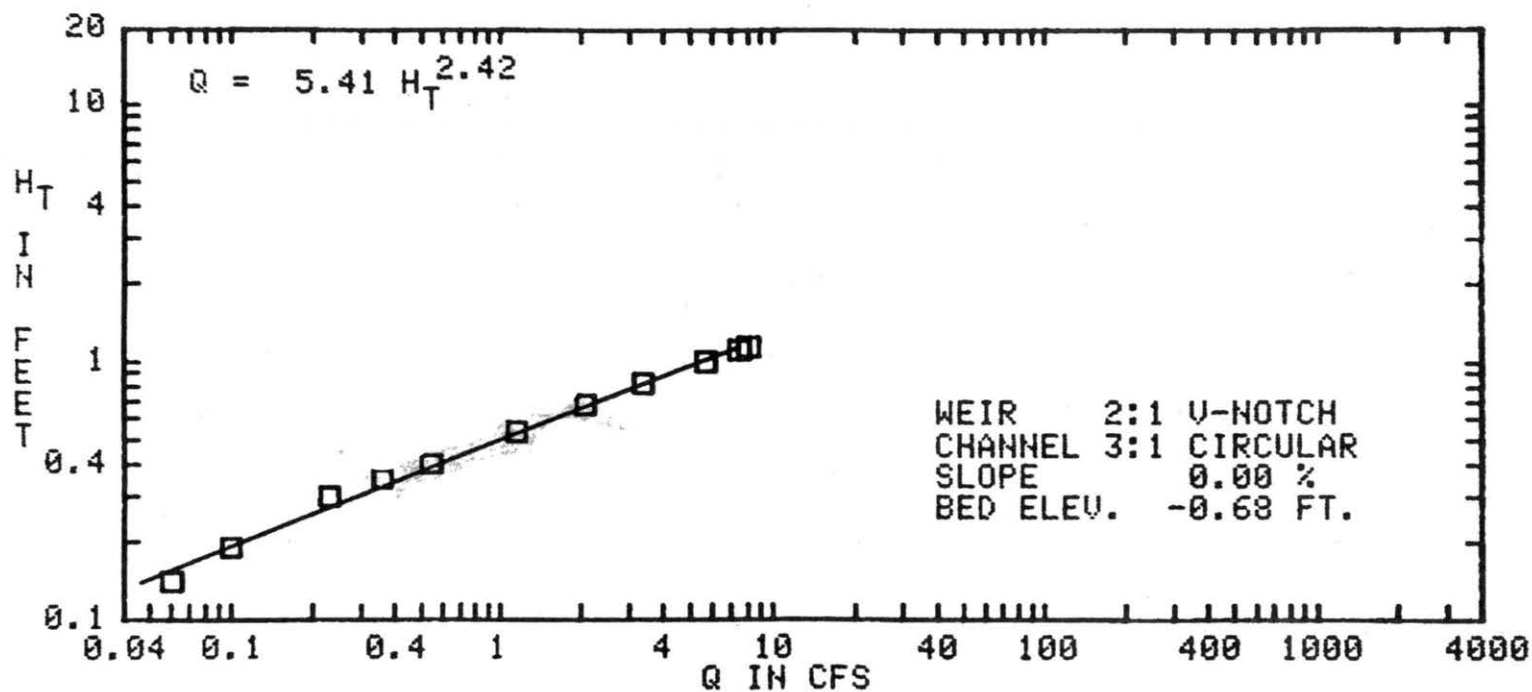

FIG. B-22 PLOT OF TOTAL HEAD versus DISCHARGE DATA POINTS

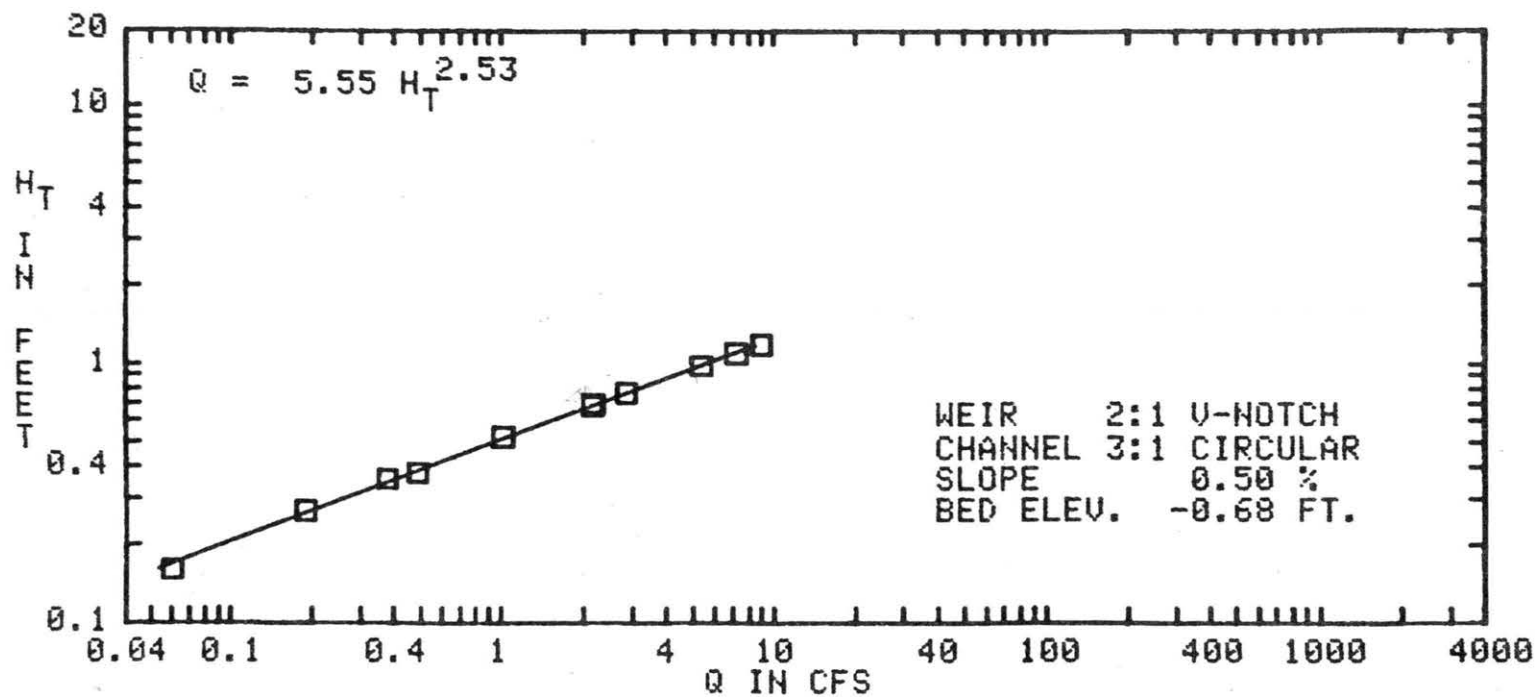

FIG. B-23 PLOT OF TOTAL HEAD versus DISCHARGE DATA POINTS

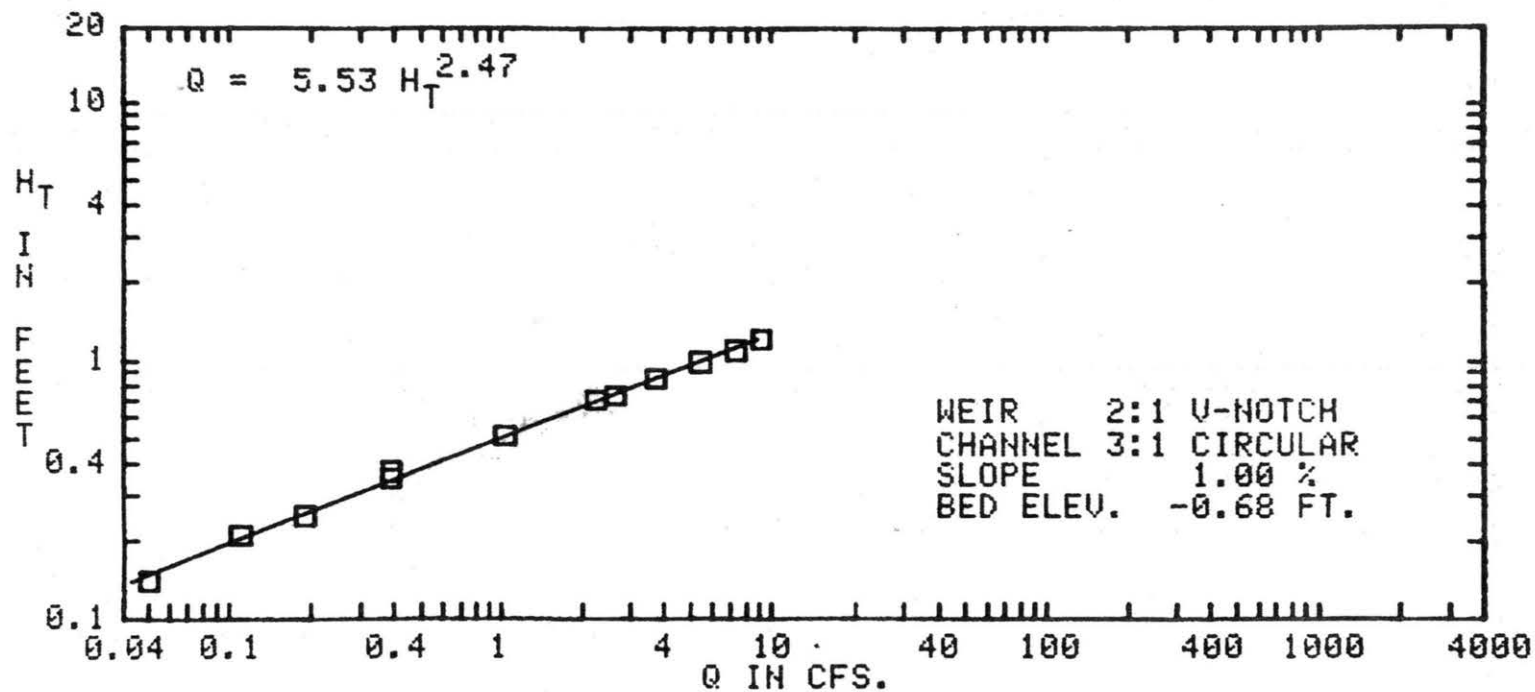

FIG. B-24 PLOT OF TOTAL HEAD versus DISCHARGE DATA POINTS

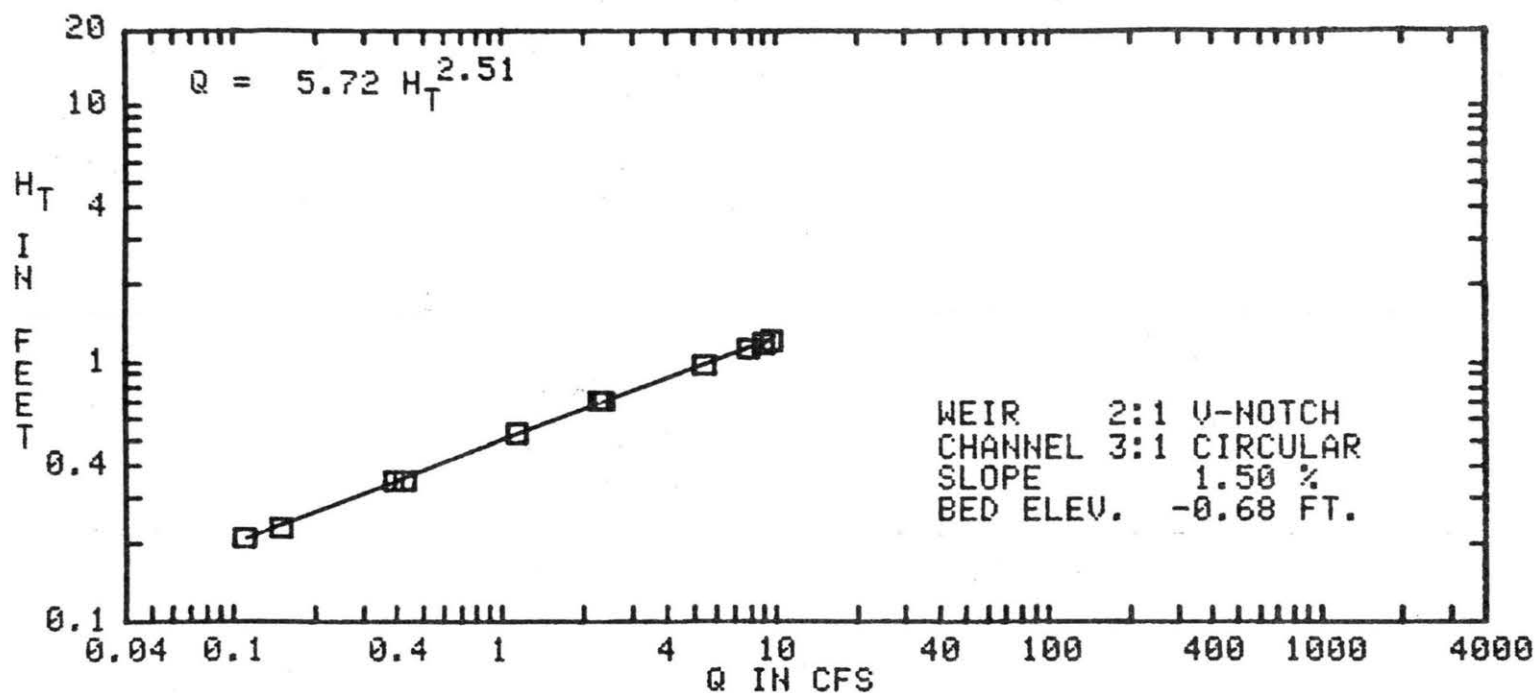

FIG. B-25 PLOT OF TOTAL HEAD versus DISCHARGE DATA POINTS

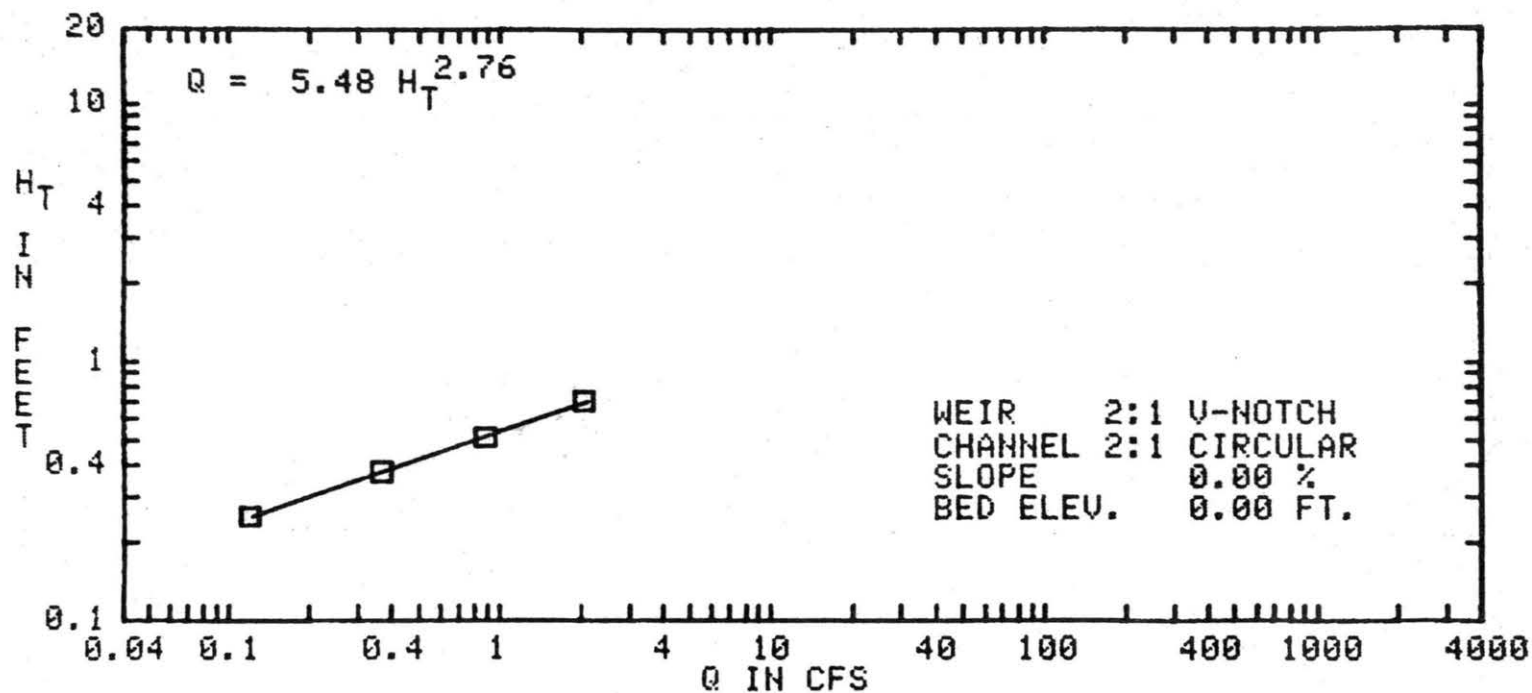

FIG. B-26 PLOT OF TOTAL HEAD versus DISCHARGE DATA POINTS

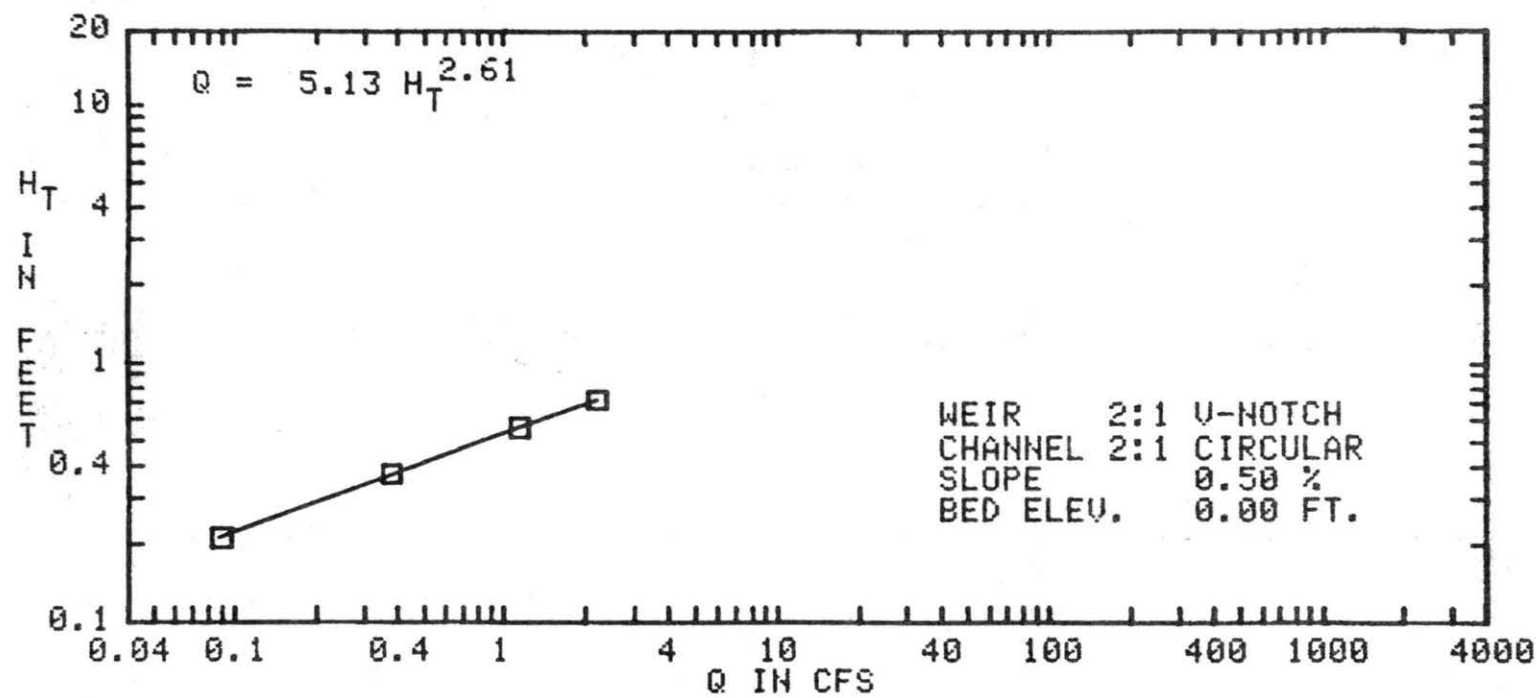

FIG. B-27 PLOT OF TOTAL HEAD versus DISCHARGE DATA POINTS

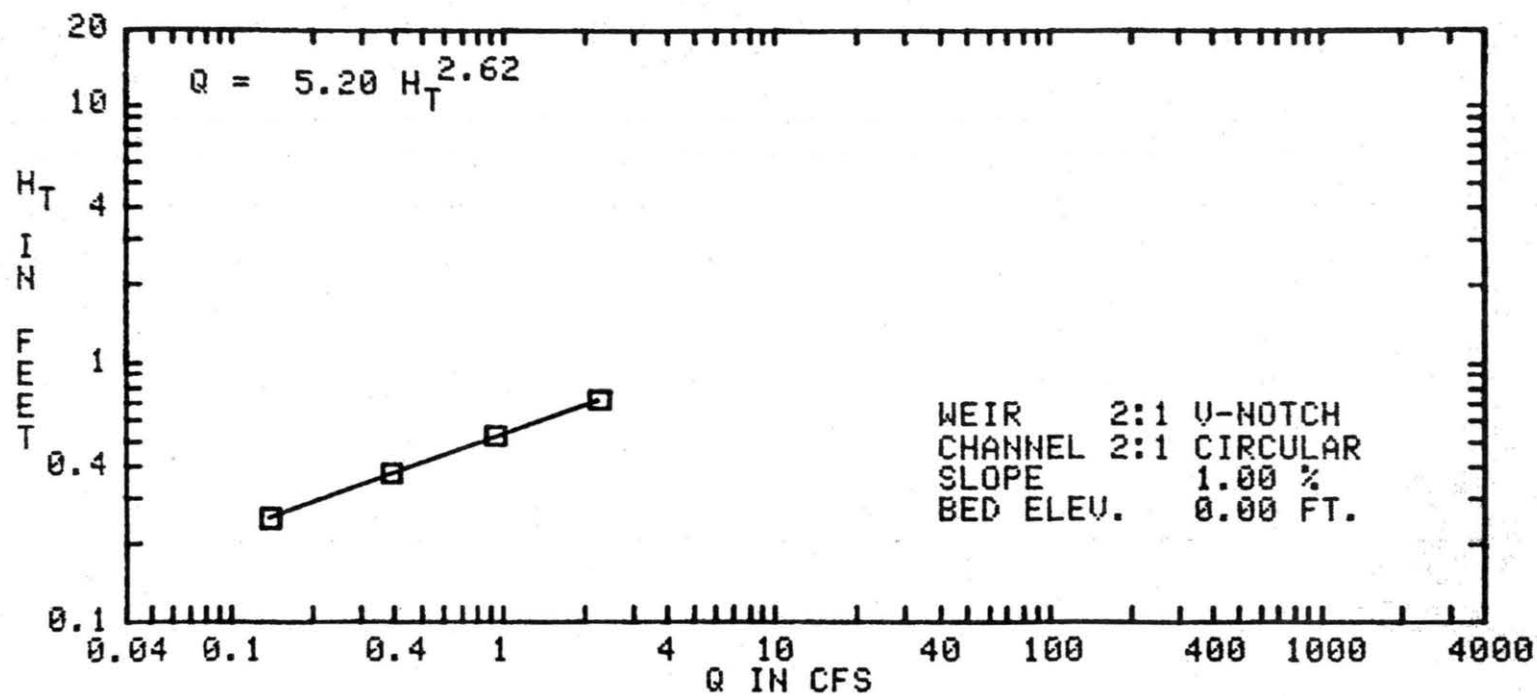

FIG. B-28 PLOT OF TOTAL HEAD versus DISCHARGE DATA POINTS

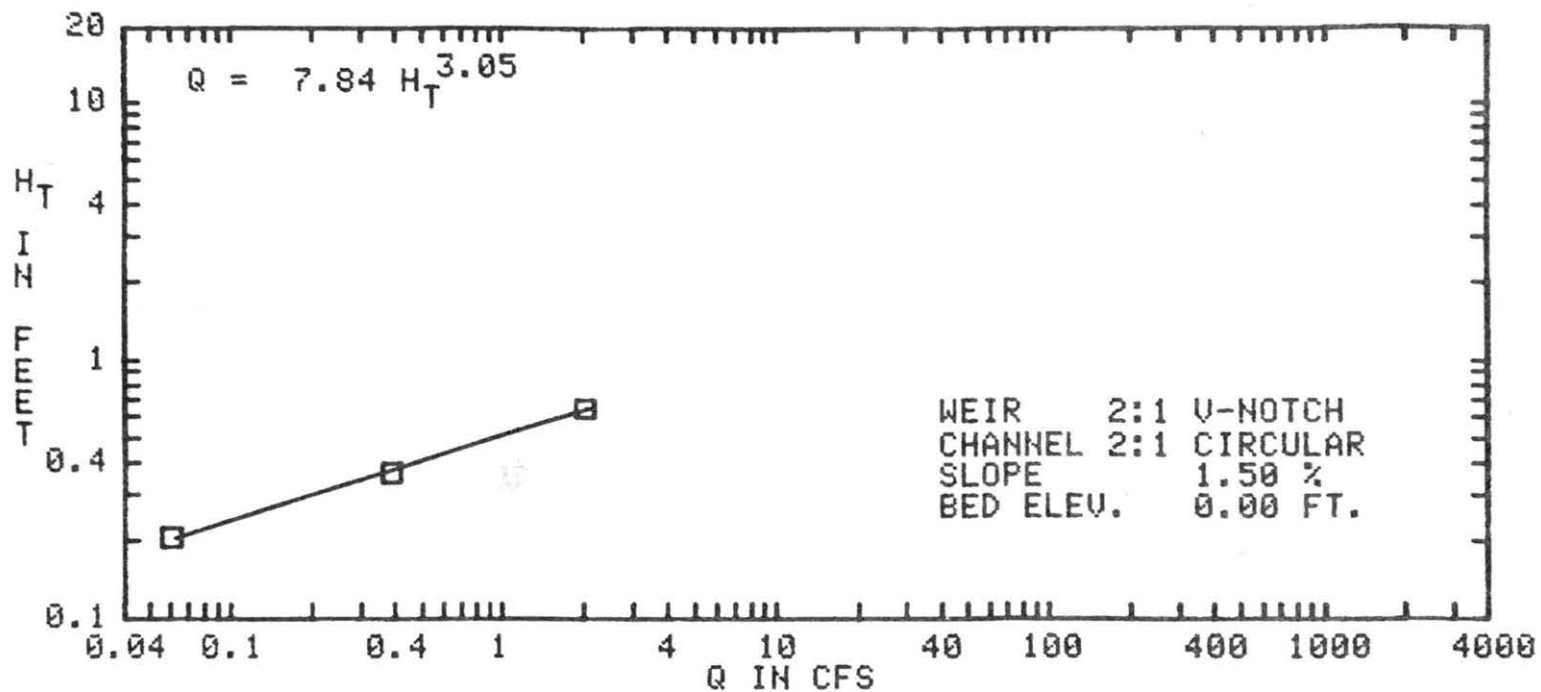

FIG. B-29 PLOT OF TOTAL HEAD versus DISCHARGE DATA POINTS

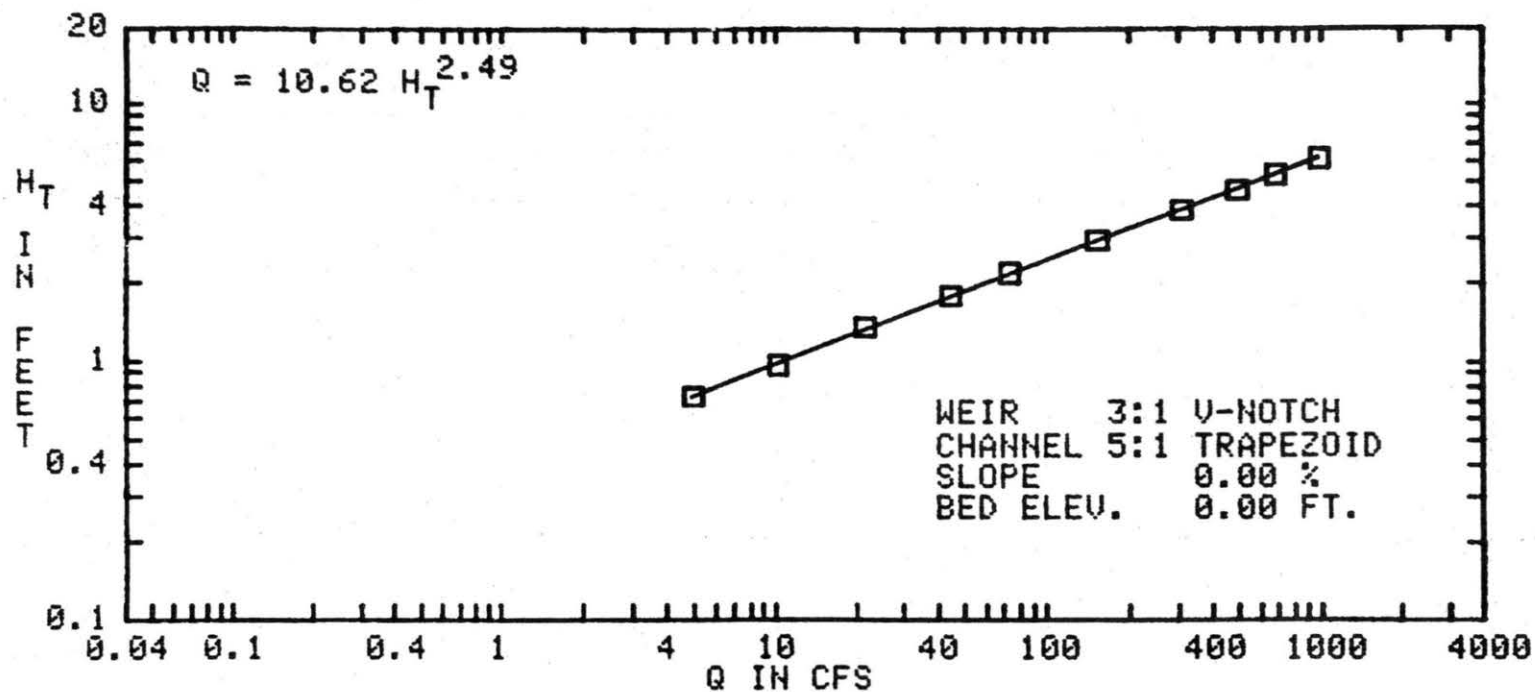

FIG. B-30 PLOT OF TOTAL HEAD versus DISCHARGE DATA POINTS

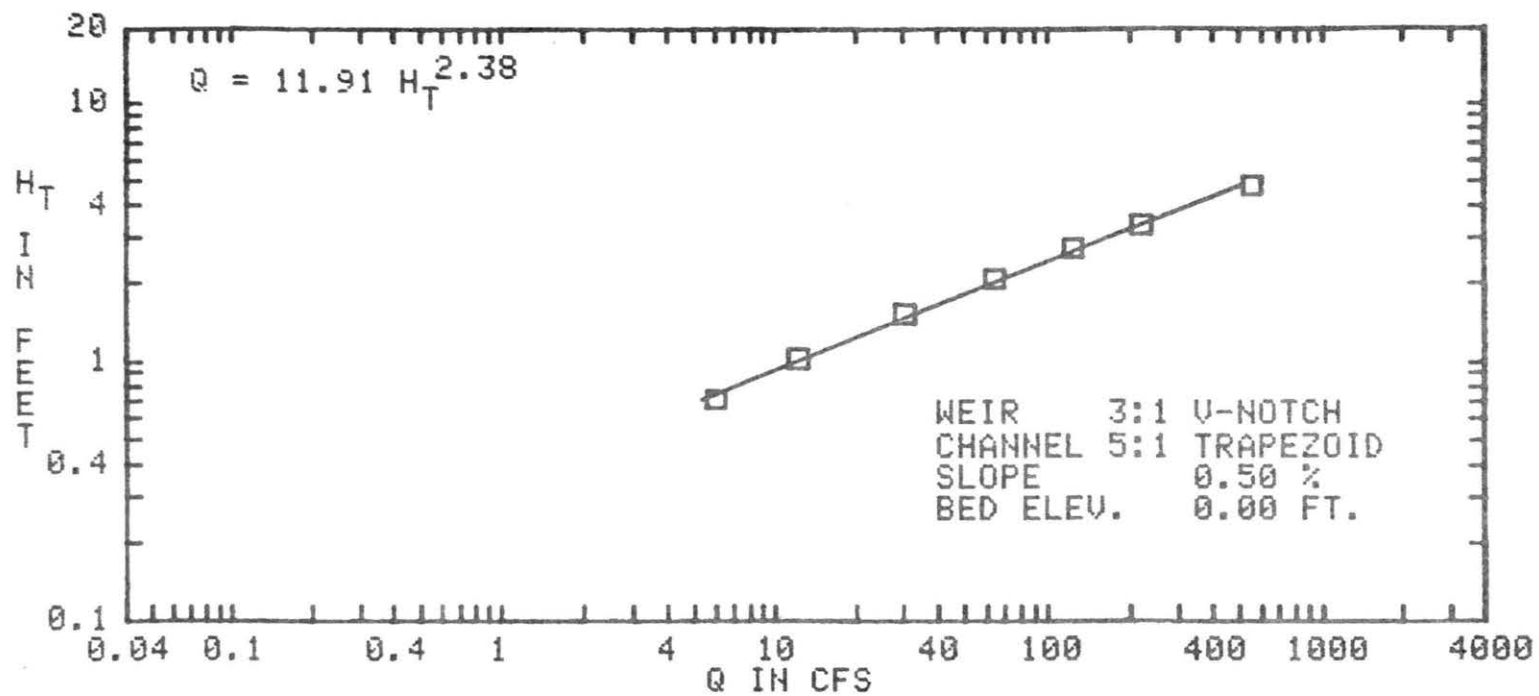

FIG. B-31 PLOT OF TOTAL HEAD versus DISCHARGE DATA POINTS

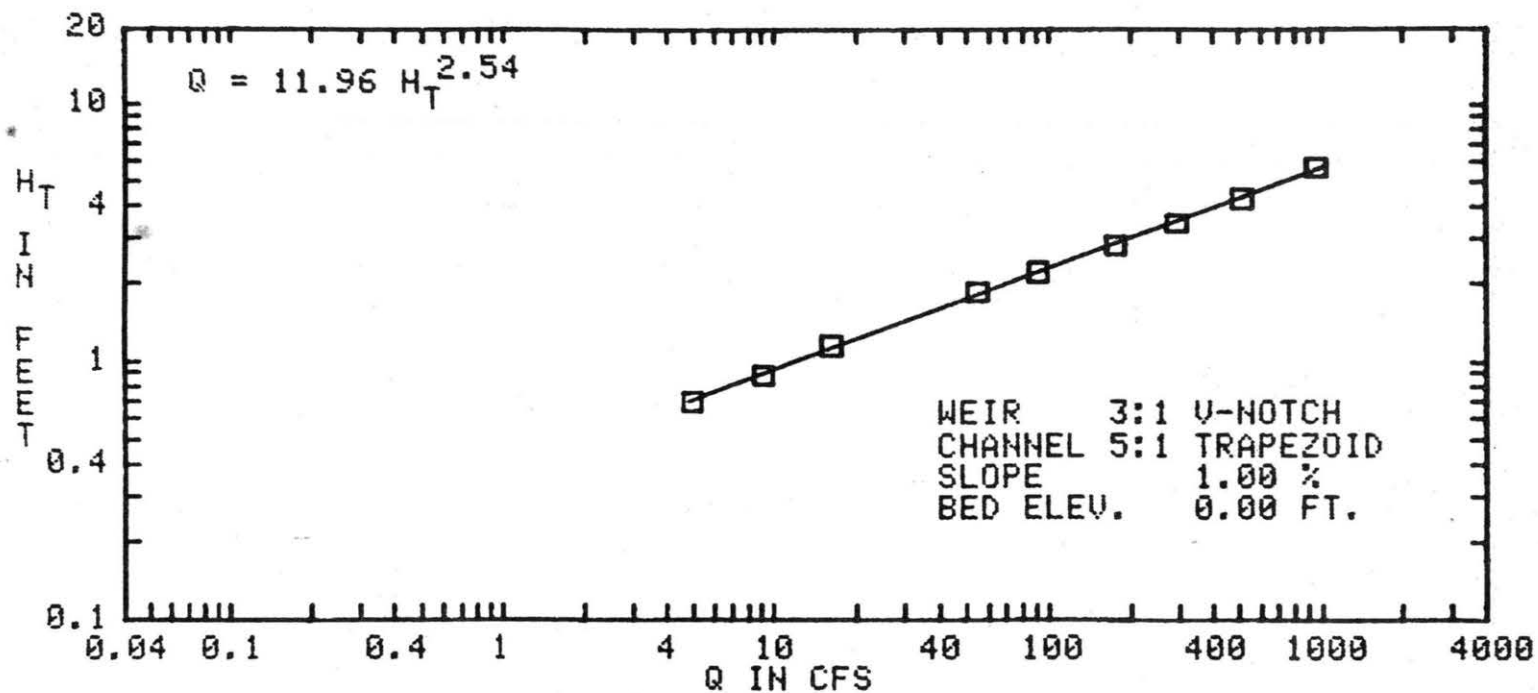

FIG. B-32 PLOT OF TOTAL HEAD versus DISCHARGE DATA POINTS

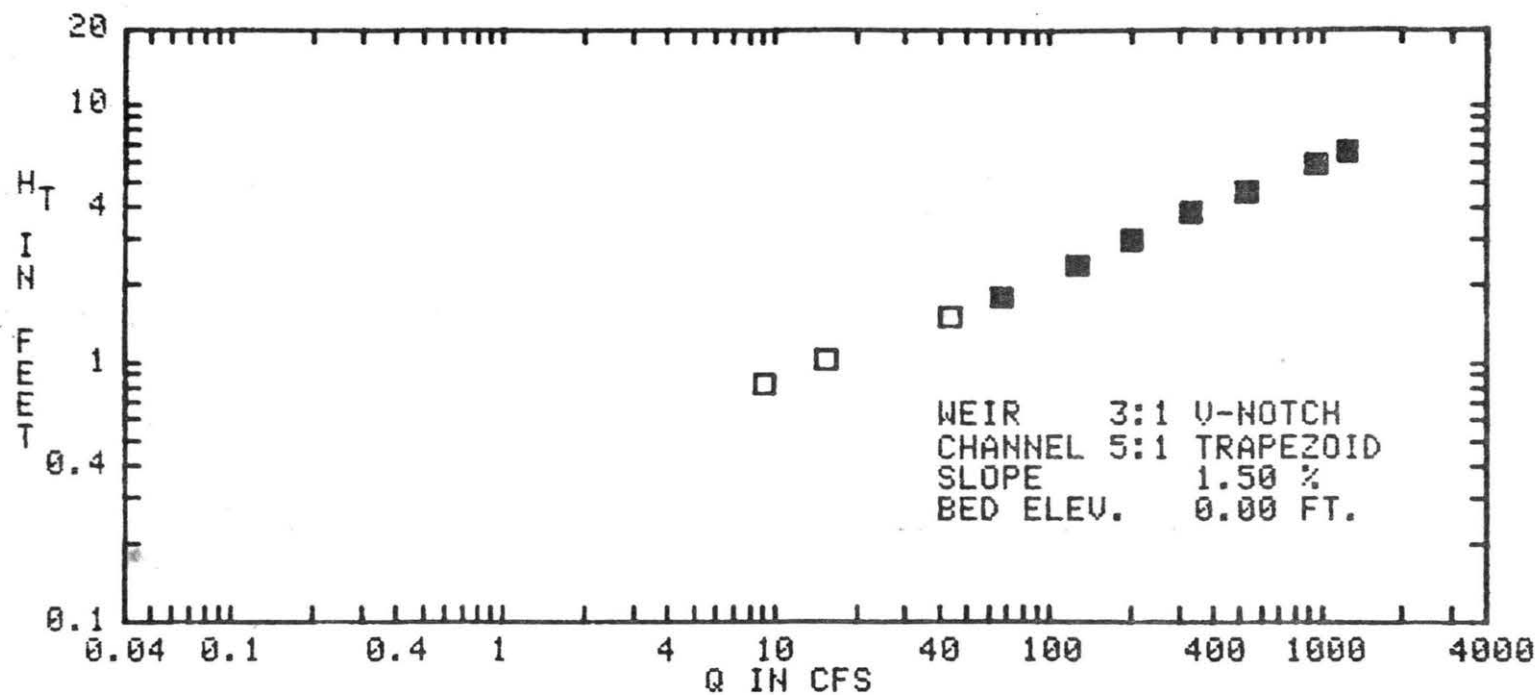

FIG. B-33 PLOT OF TOTAL HEAD versus DISCHARGE DATA POINTS

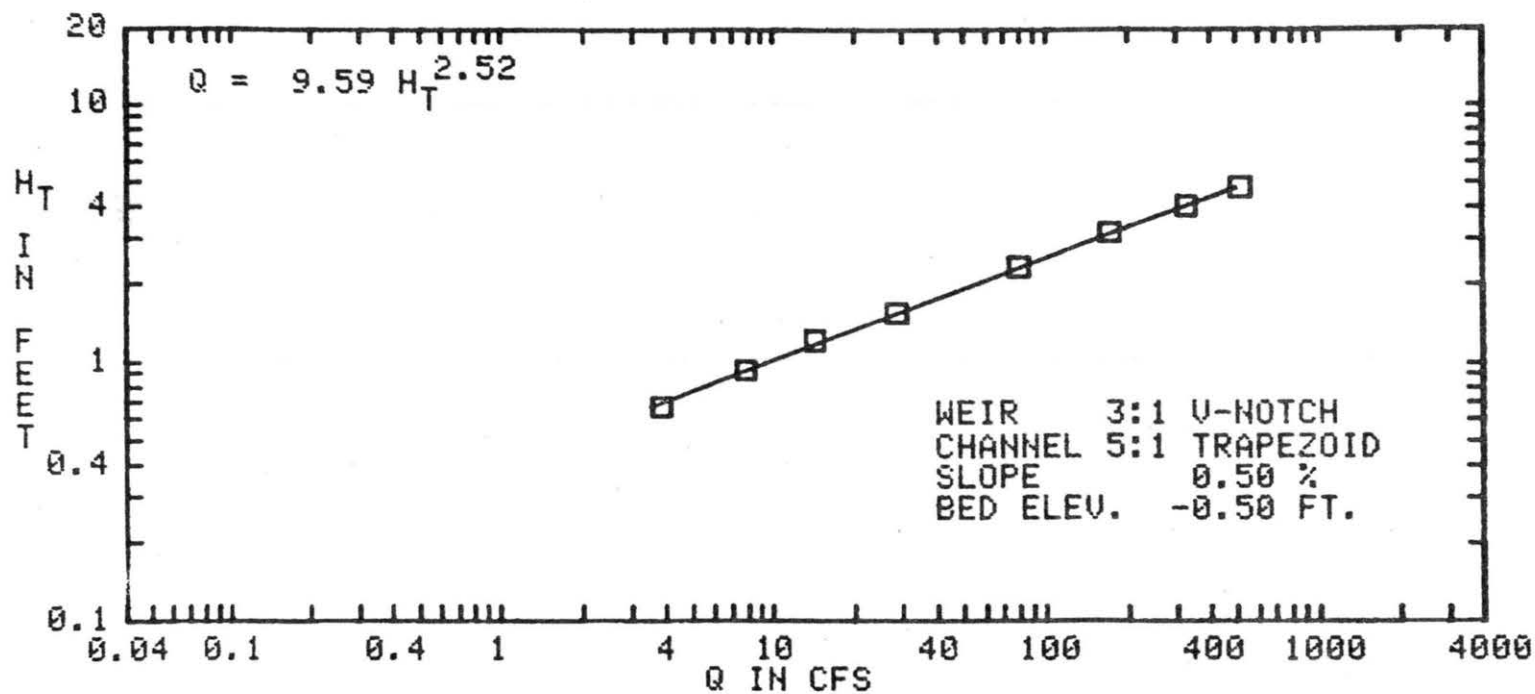

FIG. B-34 PLOT OF TOTAL HEAD versus DISCHARGE DATA POINTS

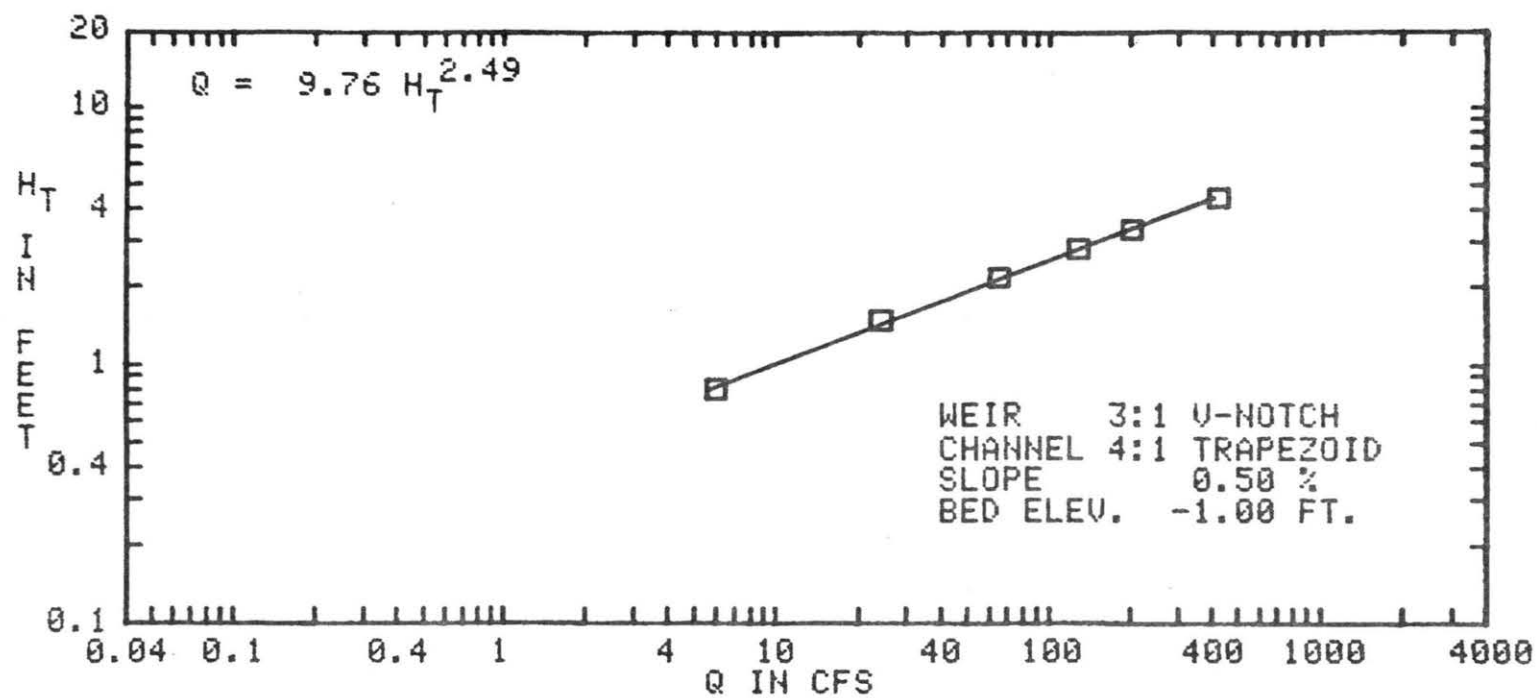

FIG. B-35 PLOT OF TOTAL HEAD versus DISCHARGE DATA POINTS

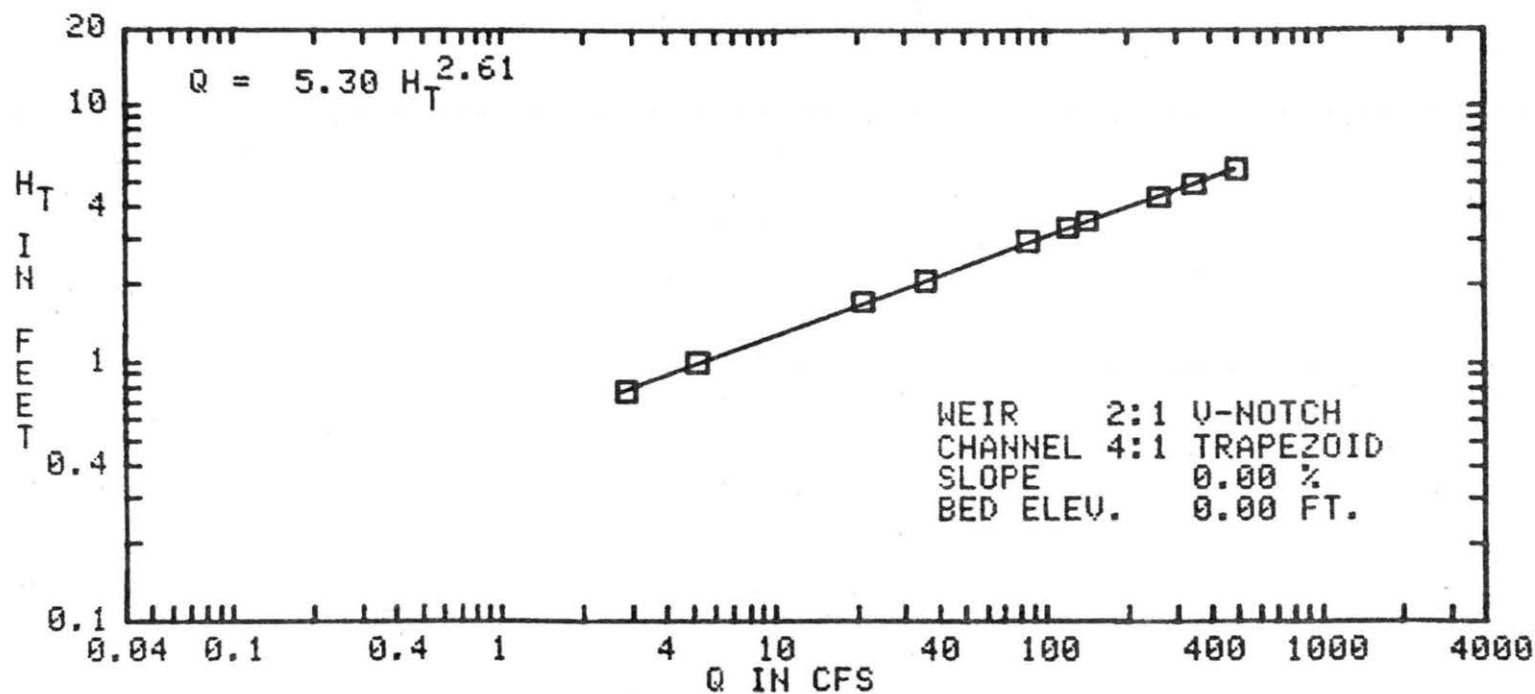

FIG. B-36 PLOT OF TOTAL HEAD versus DISCHARGE DATA POINTS

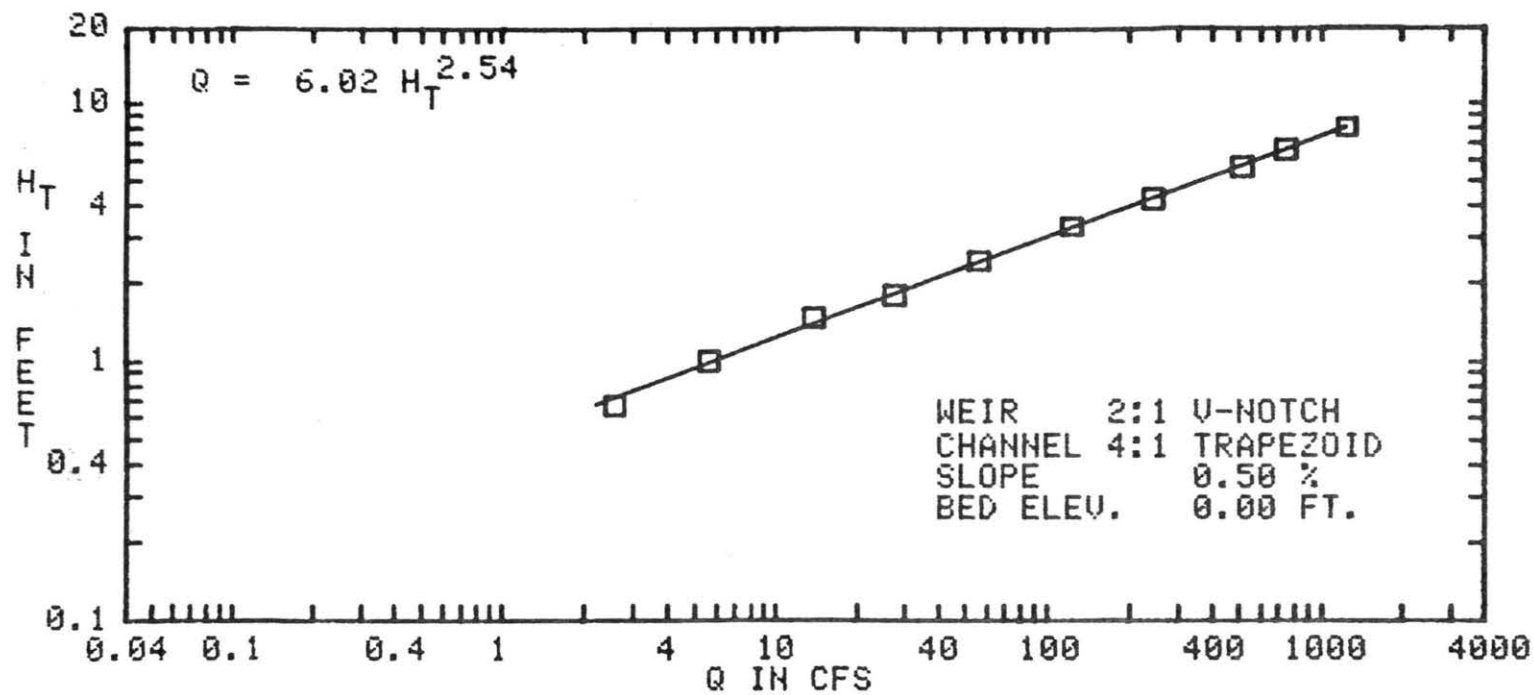

FIG. B-37 PLOT OF TOTAL HEAD versus DISCHARGE DATA POINTS

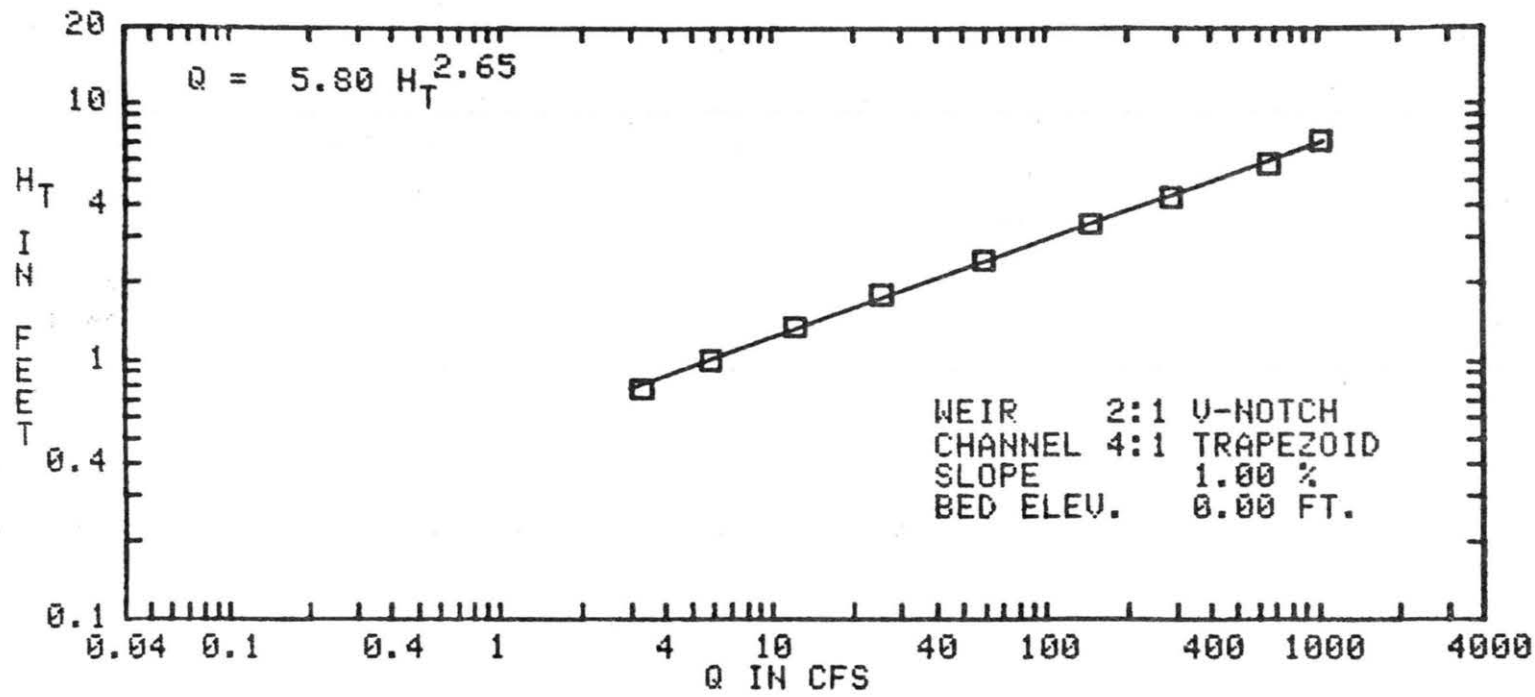

FIG. B-38 PLOT OF TOTAL HEAD versus DISCHARGE DATA POINTS

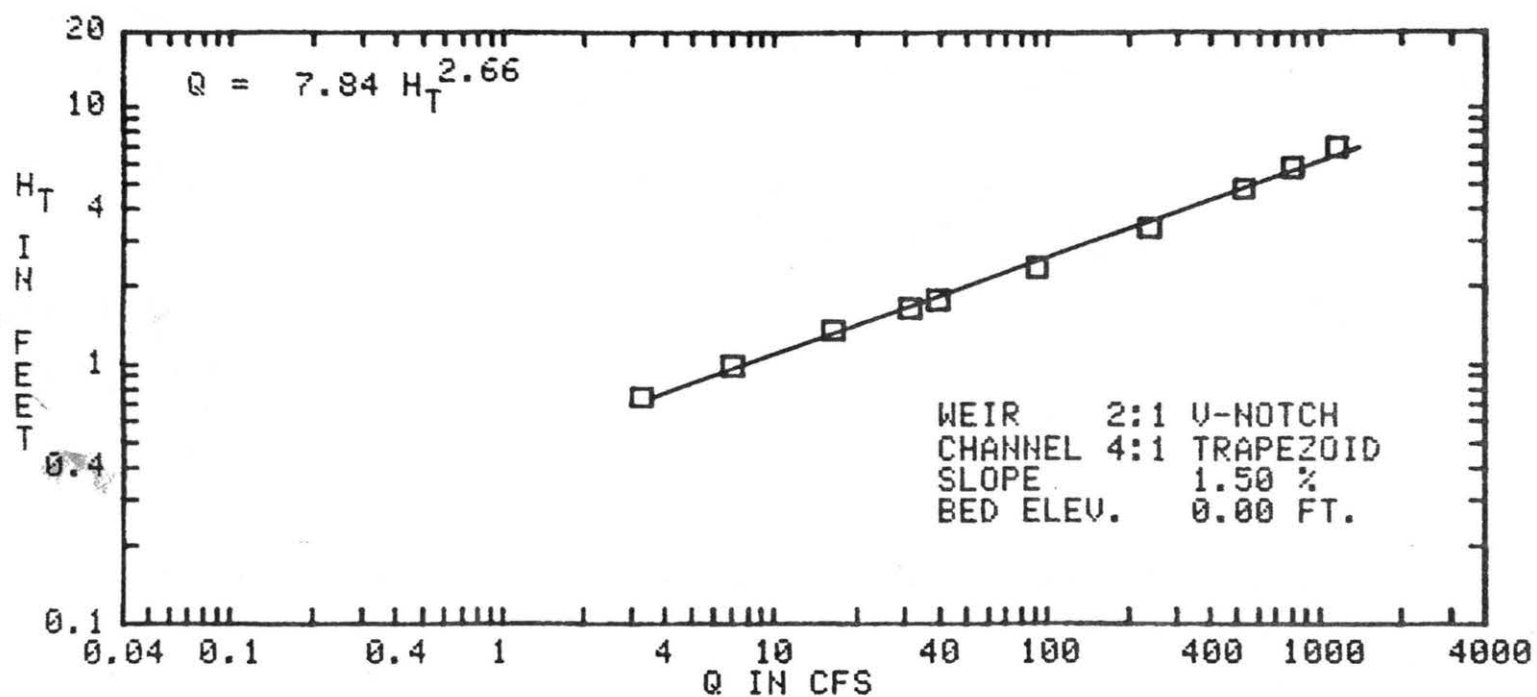

FIG. B-39 PLOT OF TOTAL HEAD versus DISCHARGE DATA POINTS

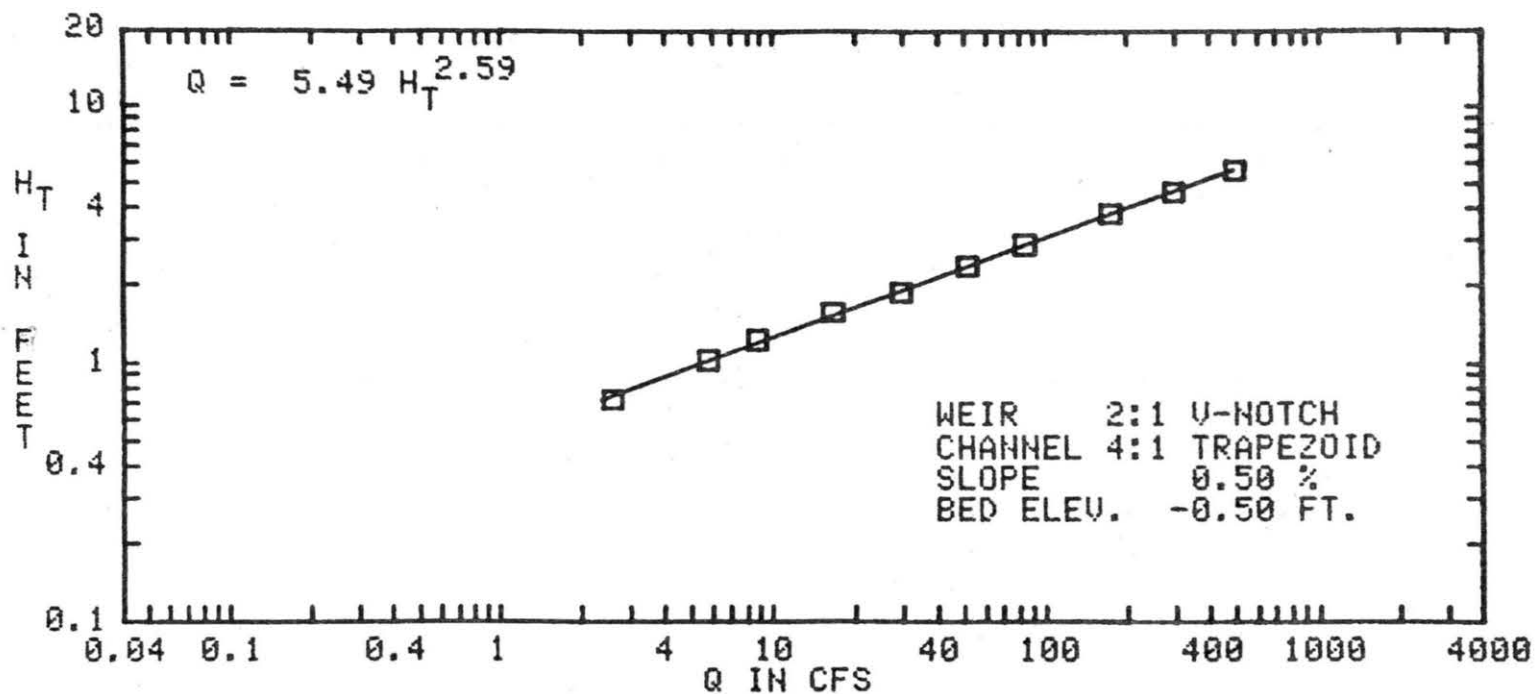

FIG. B-40 PLOT OF TOTAL HEAD versus DISCHARGE DATA POINTS

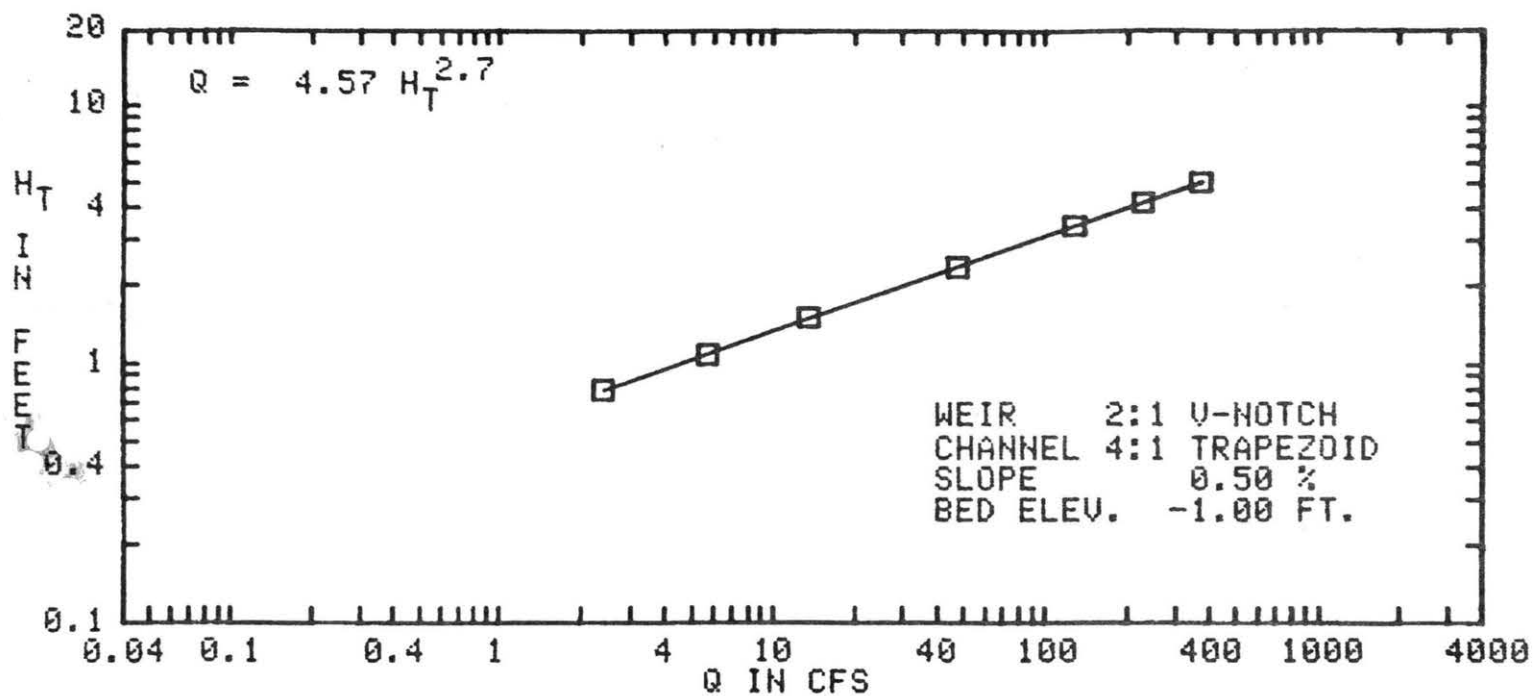

FIG. B-41 PLOT OF TOTAL HEAD versus DISCHARGE DATA POINTS

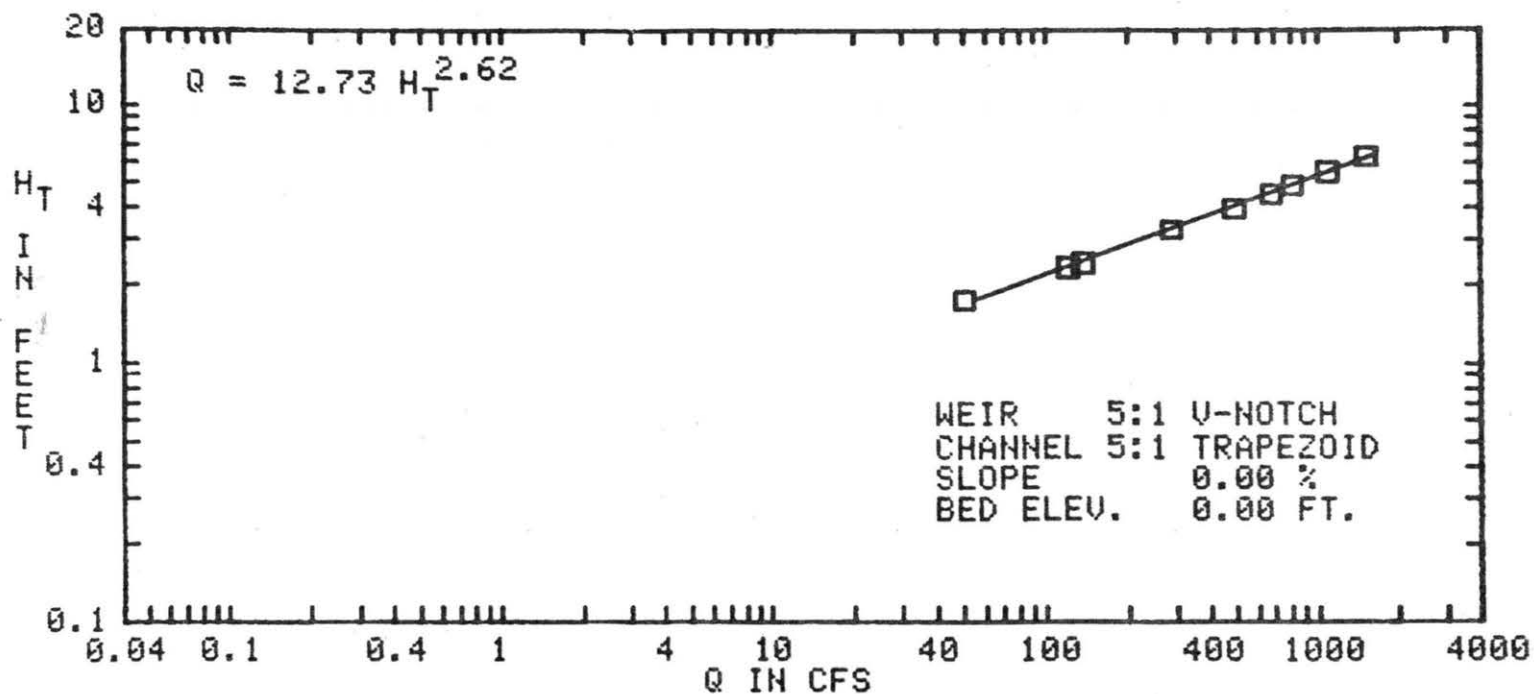

FIG. B-42 PLOT OF TOTAL HEAD versus DISCHARGE DATA POINTS

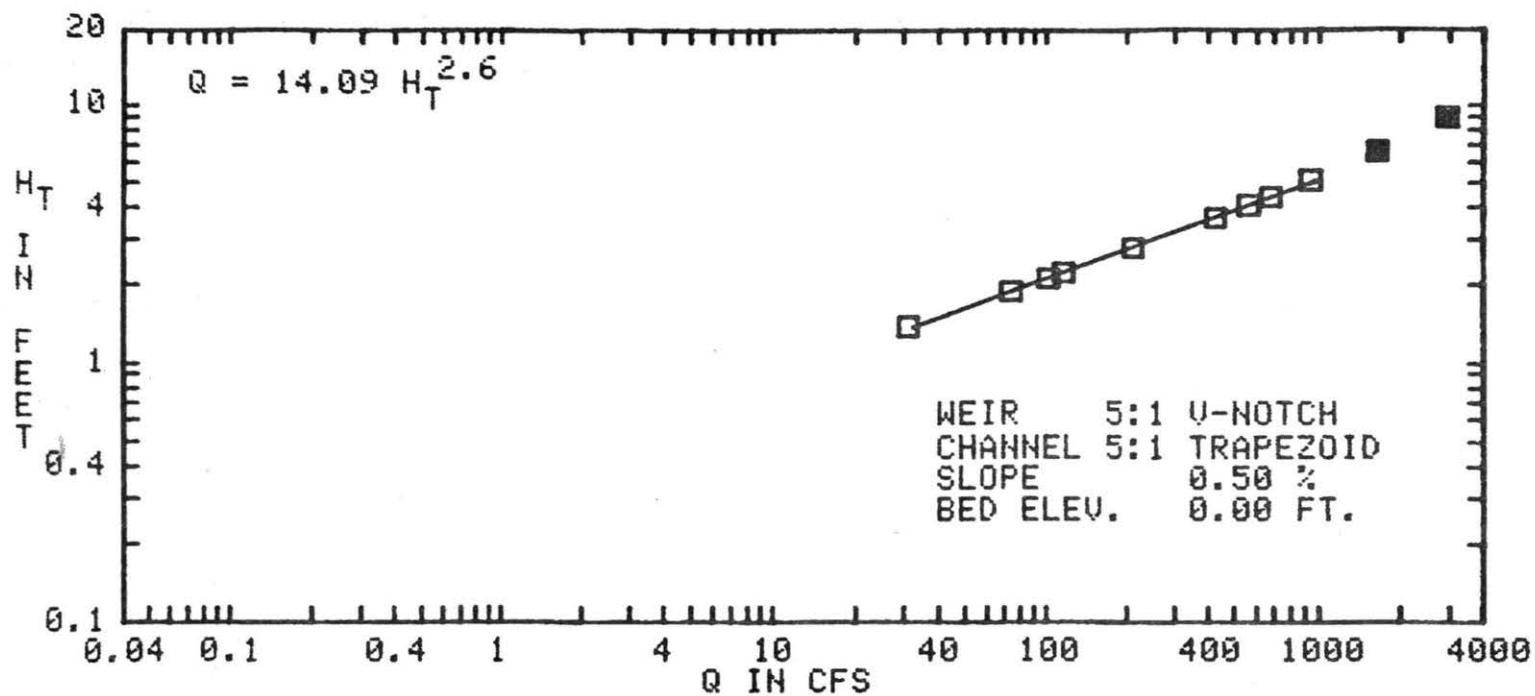

FIG. B-43 PLOT OF TOTAL HEAD versus DISCHARGE DATA POINTS

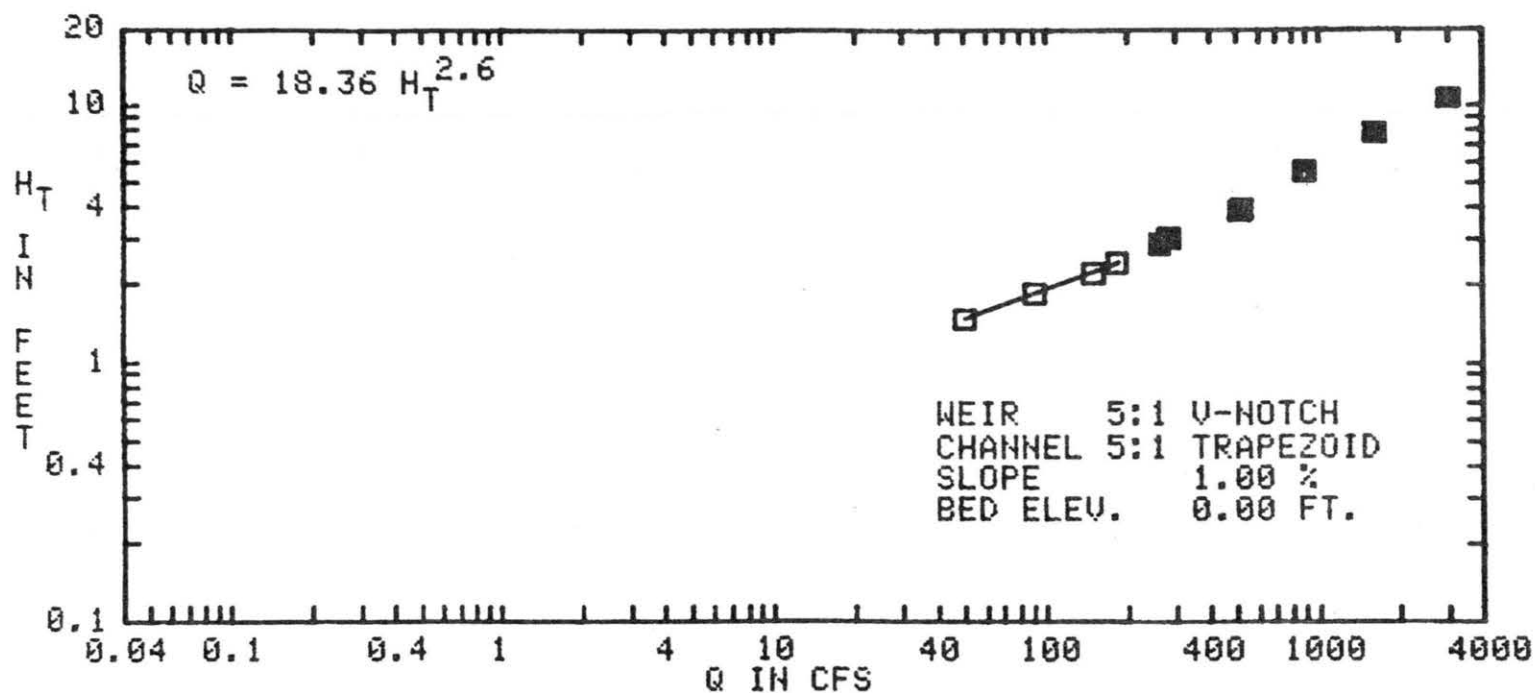

FIG. B-44 PLOT OF TOTAL HEAD versus DISCHARGE DATA POINTS

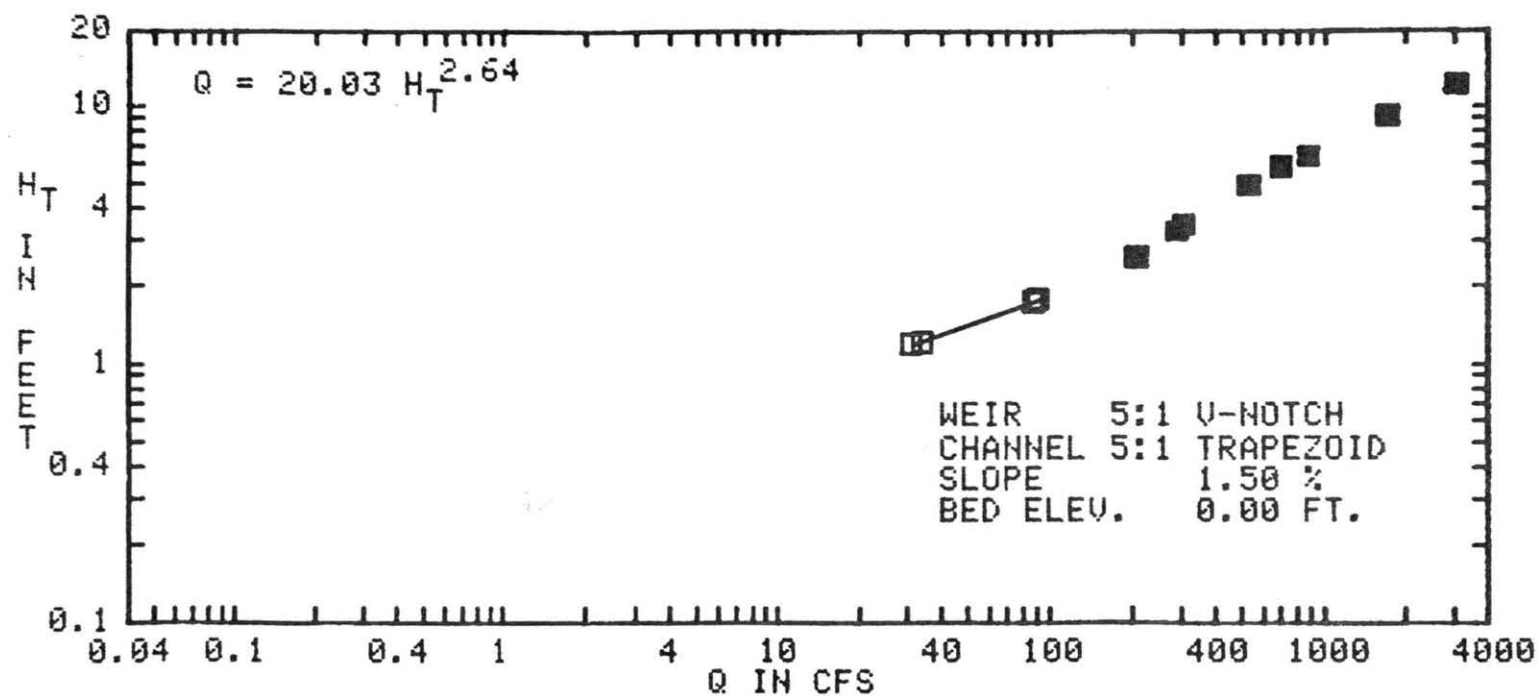

FIG. B-45 PLOT OF TOTAL HEAD versus DISCHARGE DATA POINTS

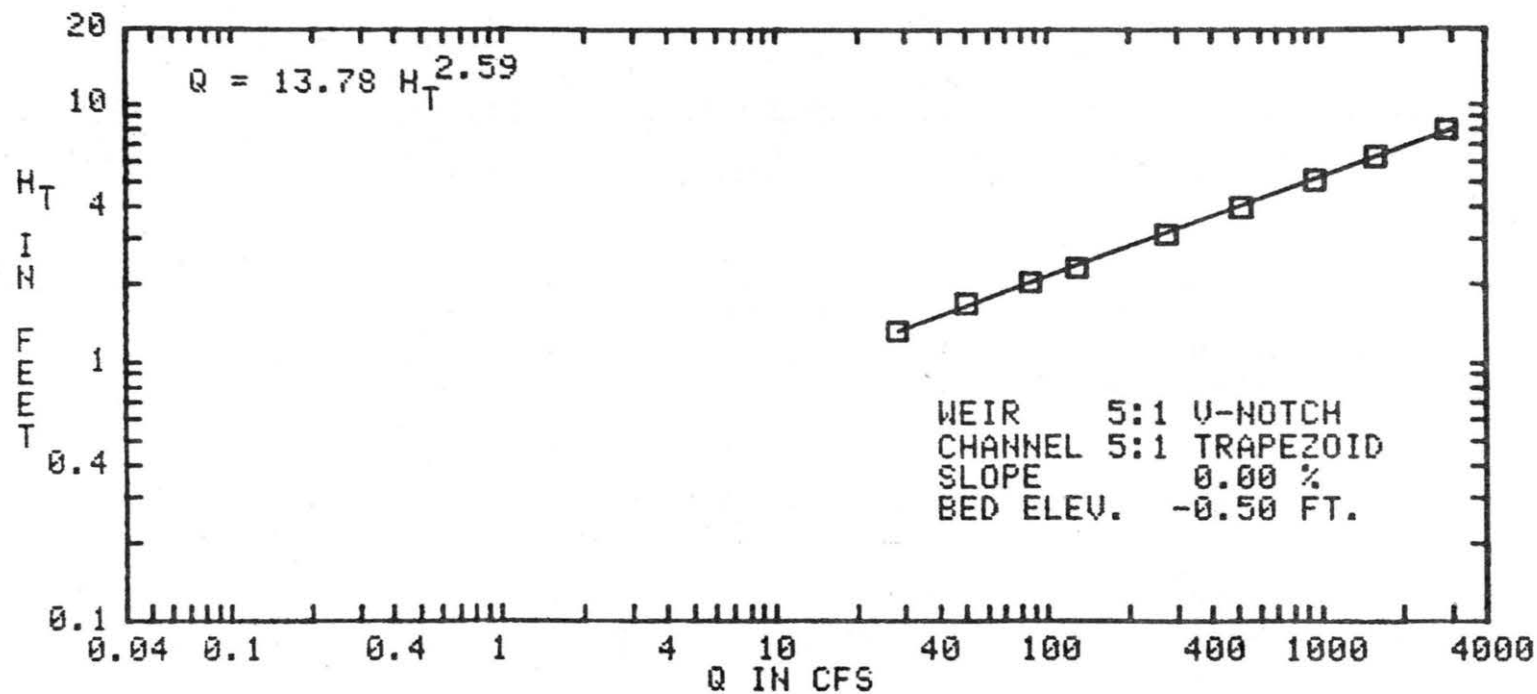

FIG. B-46 PLOT OF TOTAL HEAD versus DISCHARGE DATA POINTS

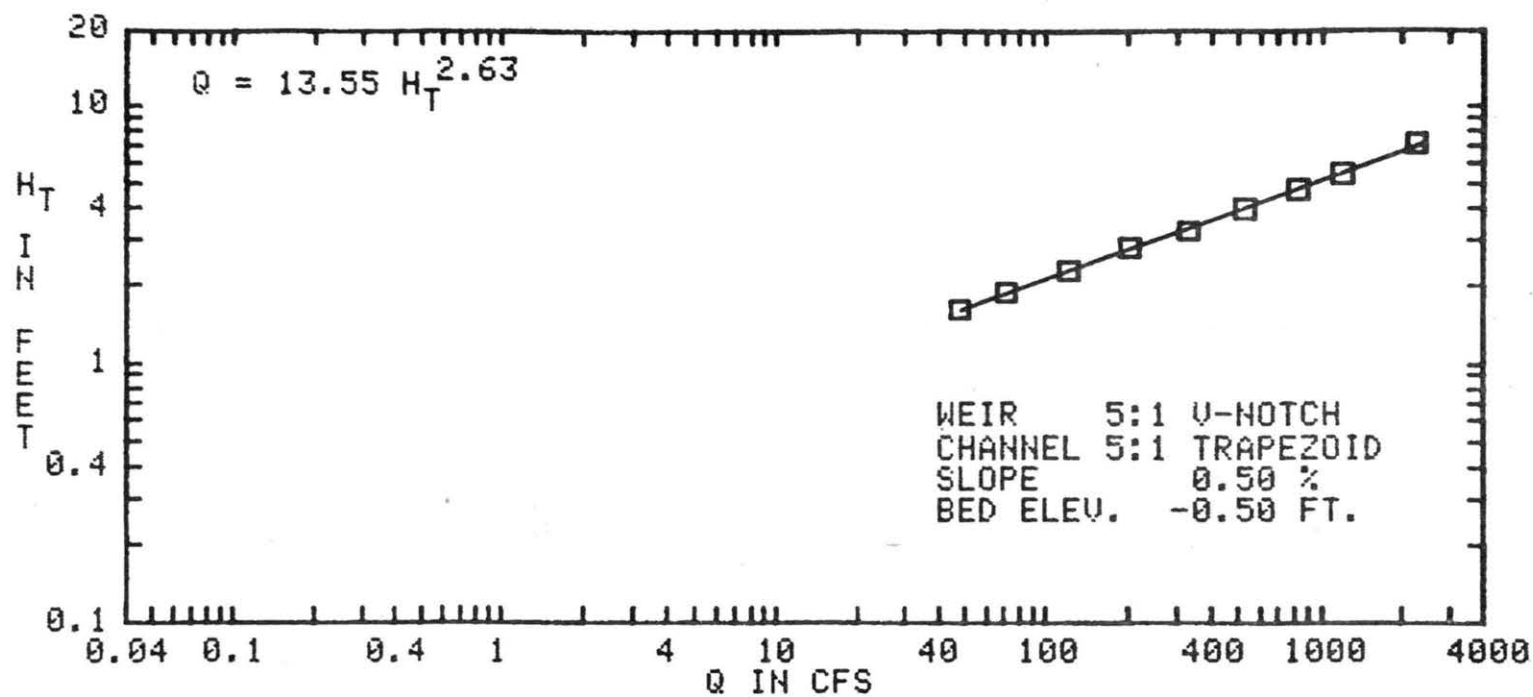

FIG. B-47 PLOT OF TOTAL HEAD versus DISCHARGE DATA POINTS

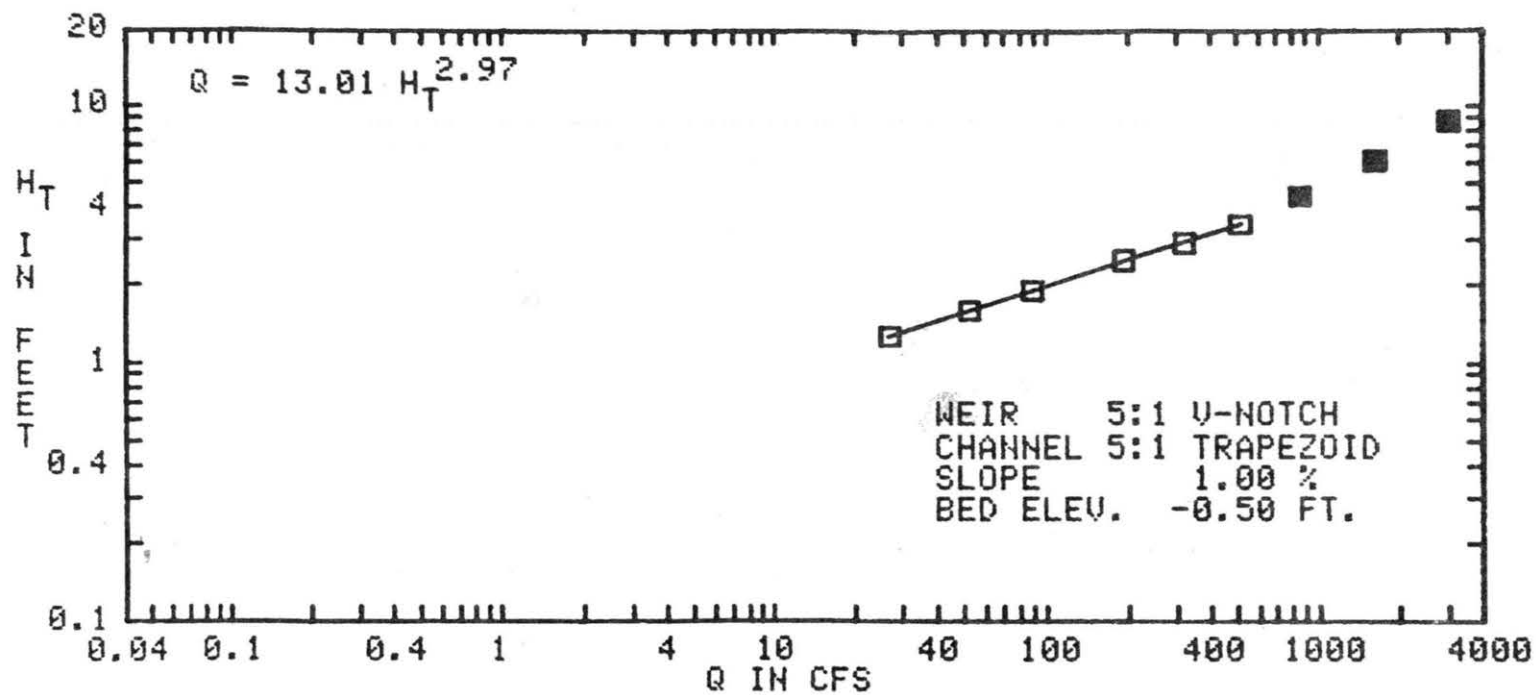

FIG. B-48 PLOT OF TOTAL HEAD versus DISCHARGE DATA POINTS

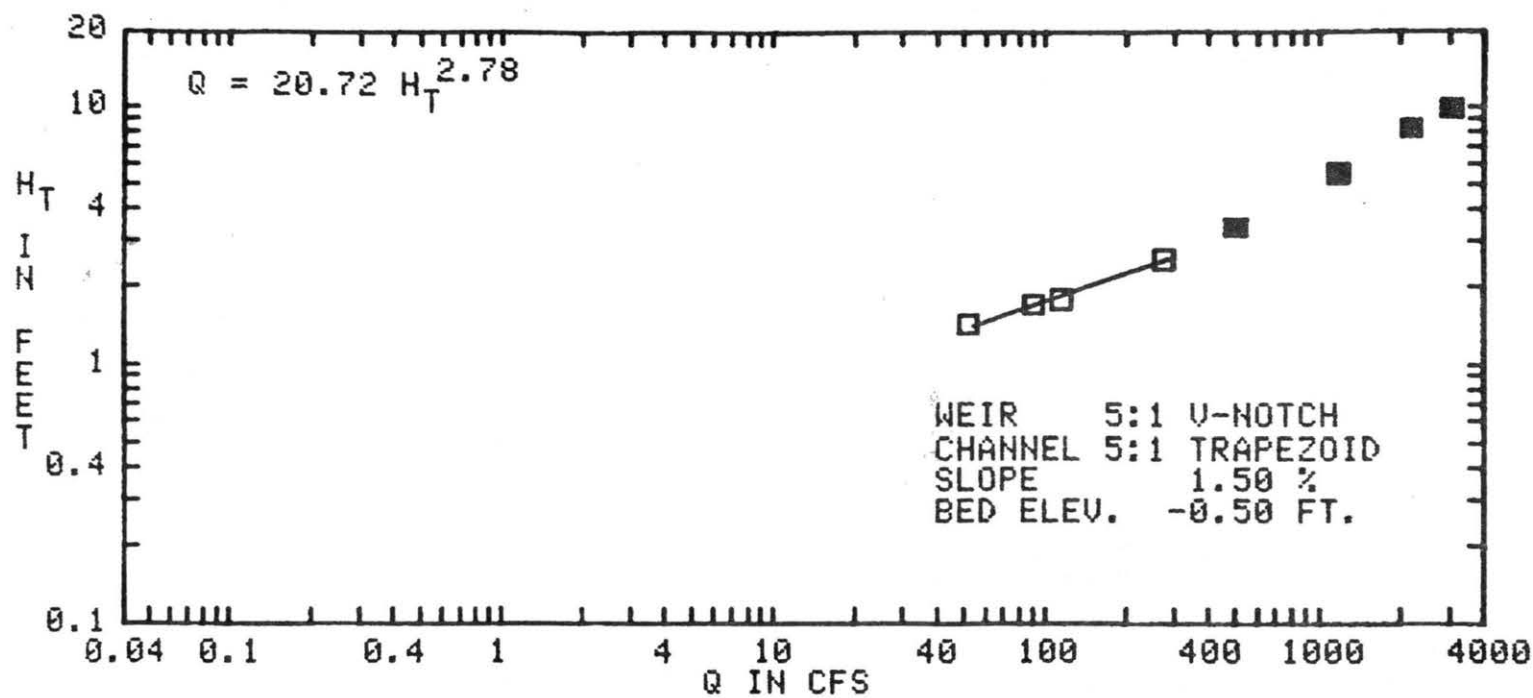

FIG. B-49 PLOT OF TOTAL HEAD versus DISCHARGE DATA POINTS

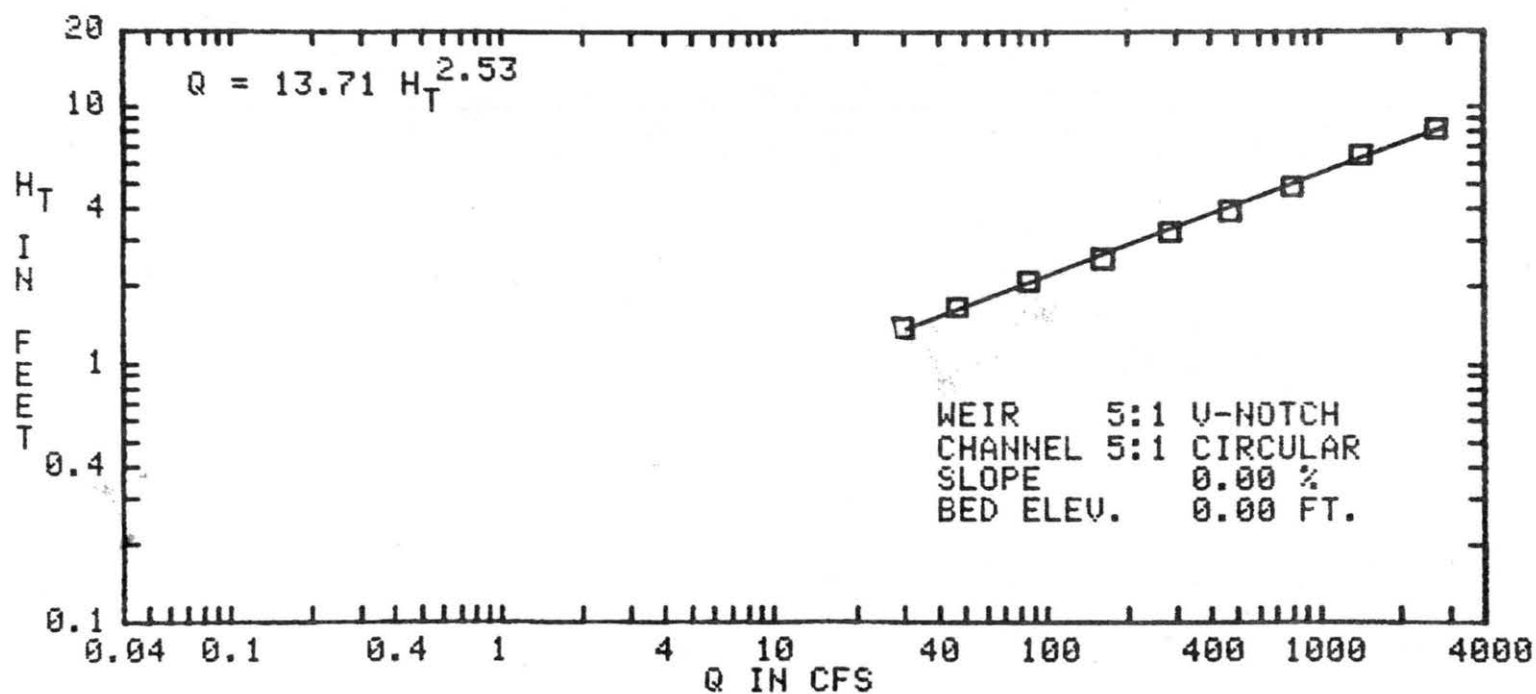

FIG. B-50 PLOT OF TOTAL HEAD versus DISCHARGE DATA POINTS

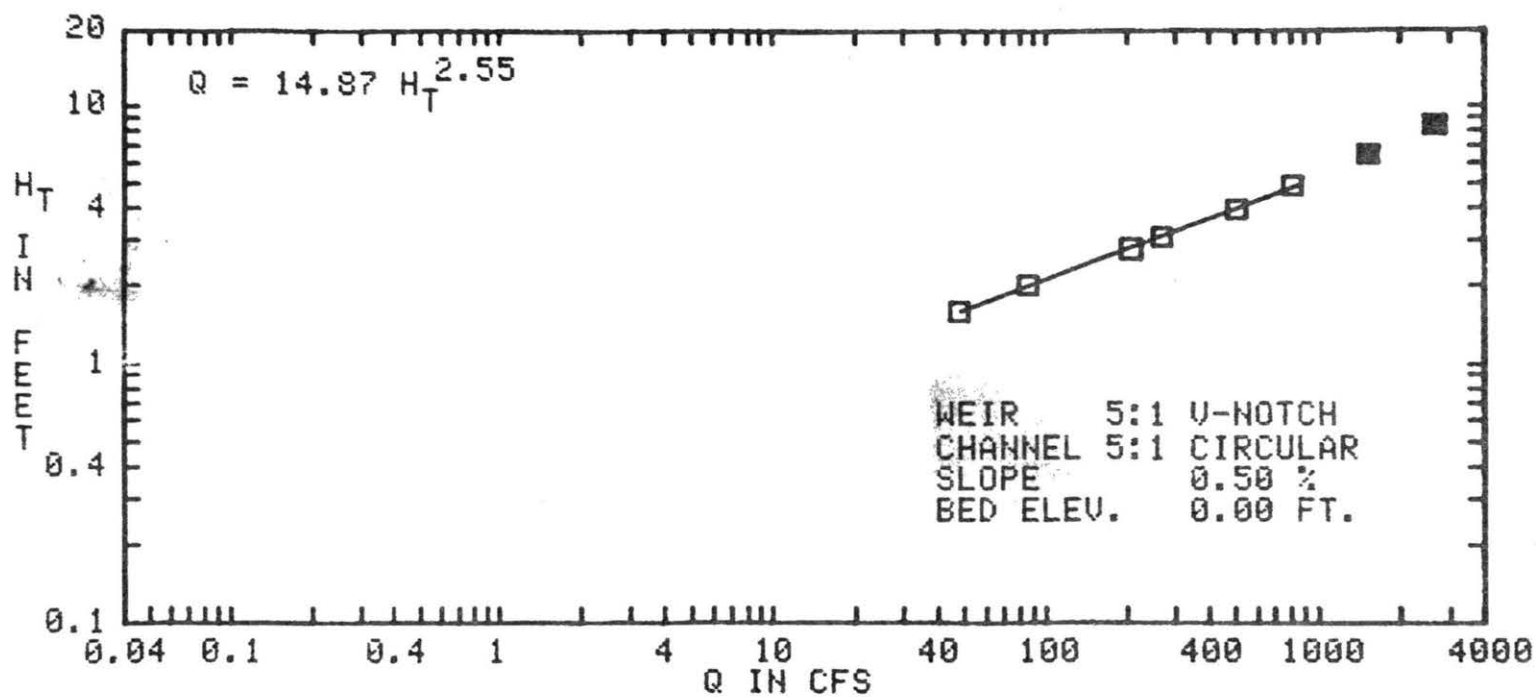

FIG. B-51 PLOT OF TOTAL HEAD versus DISCHARGE DATA POINTS

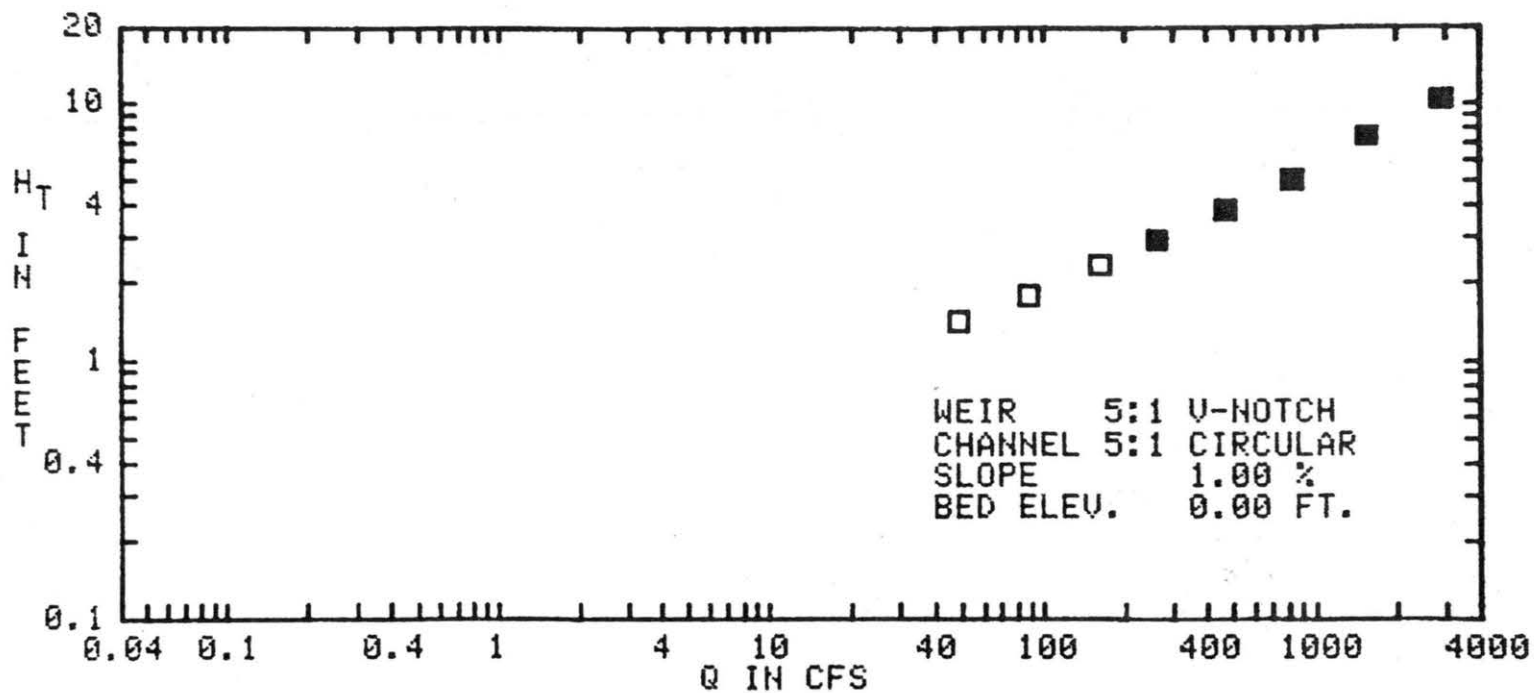

FIG. B-52 PLOT OF TOTAL HEAD versus DISCHARGE DATA POINTS

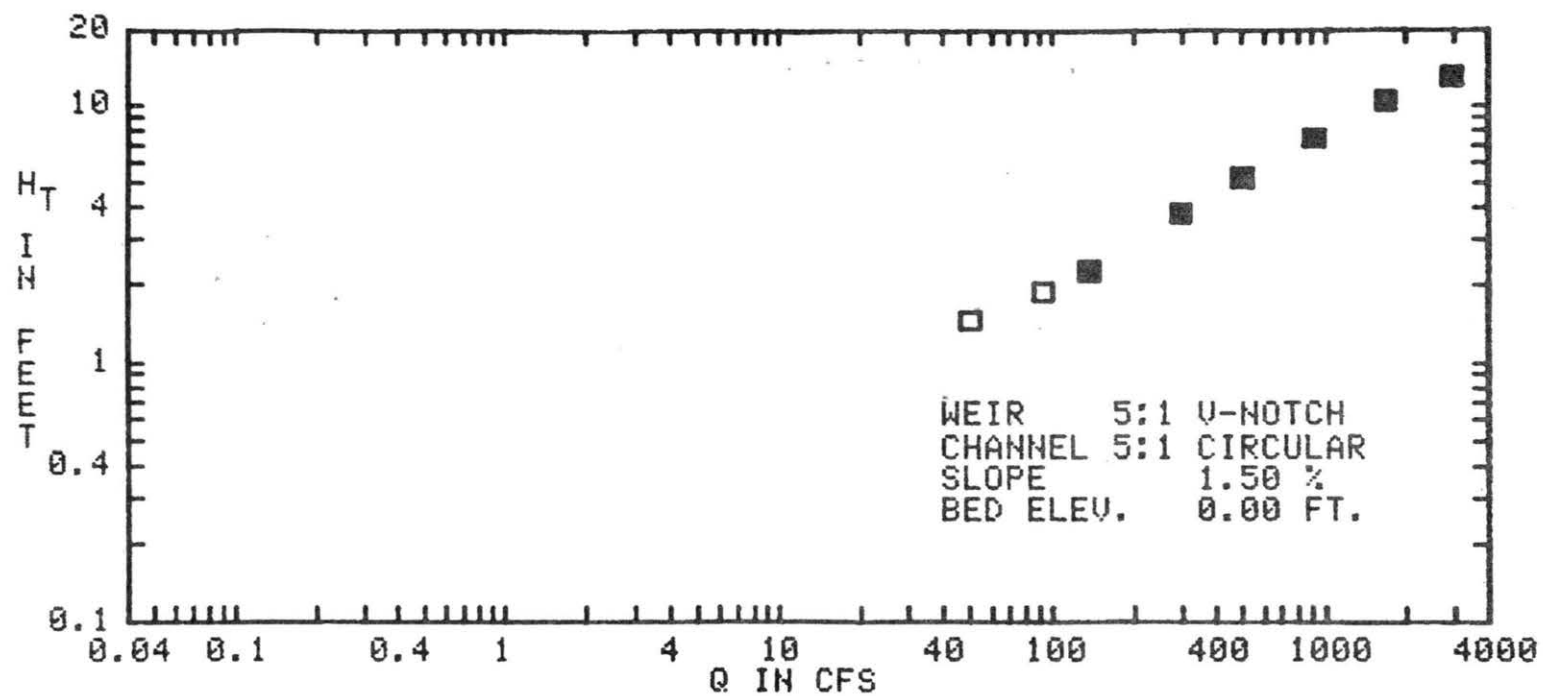

FIG. B-53 PLOT OF TOTAL HEAD versus DISCHARGE DATA POINTS

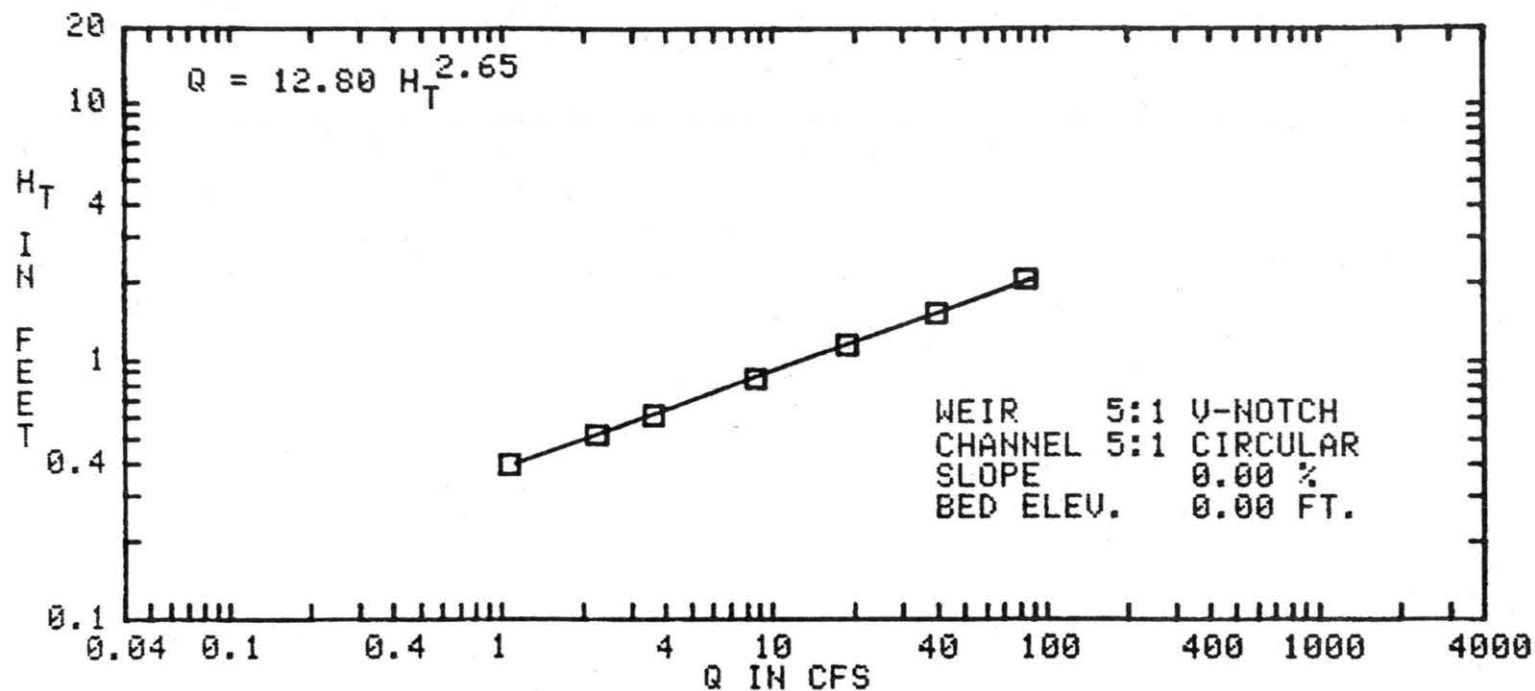

FIG. B-54 PLOT OF TOTAL HEAD versus DISCHARGE DATA POINTS

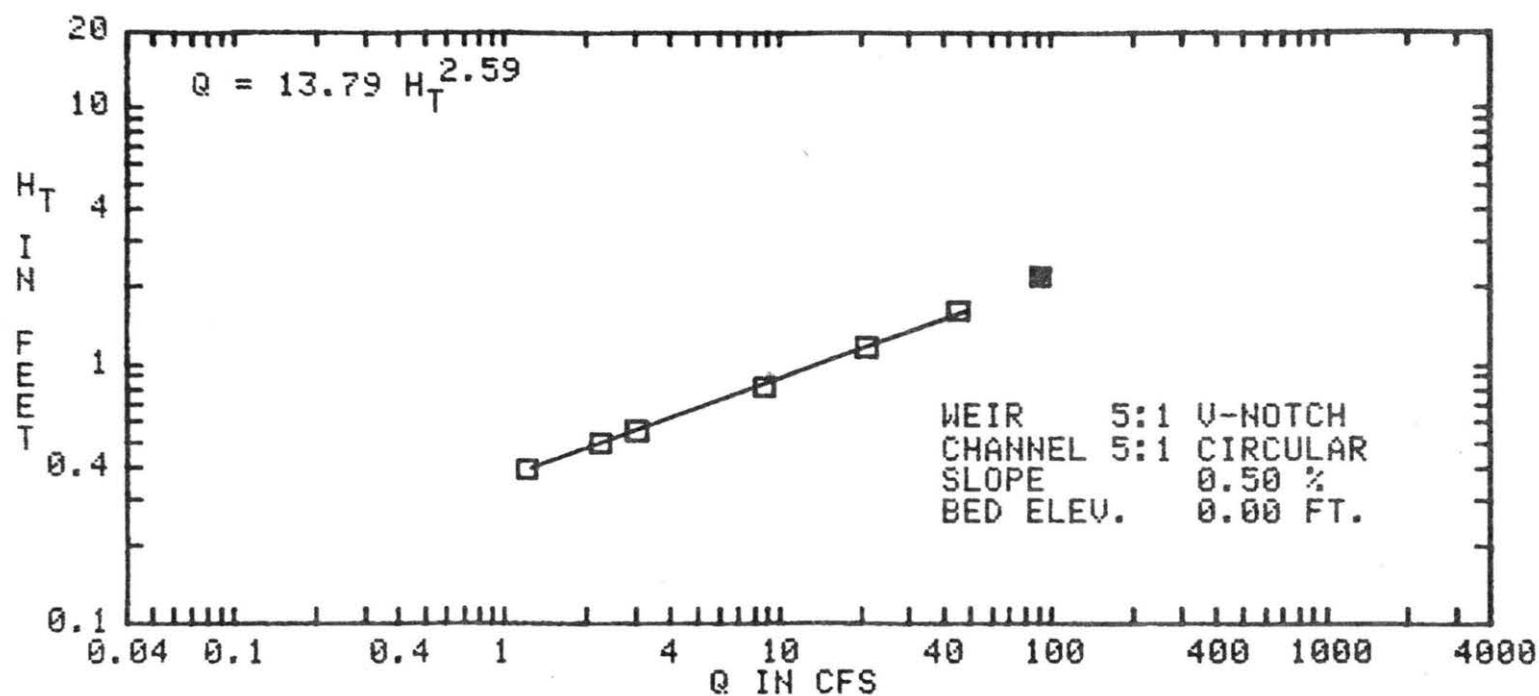

FIG. B-55 PLOT OF TOTAL HEAD versus DISCHARGE DATA POINTS

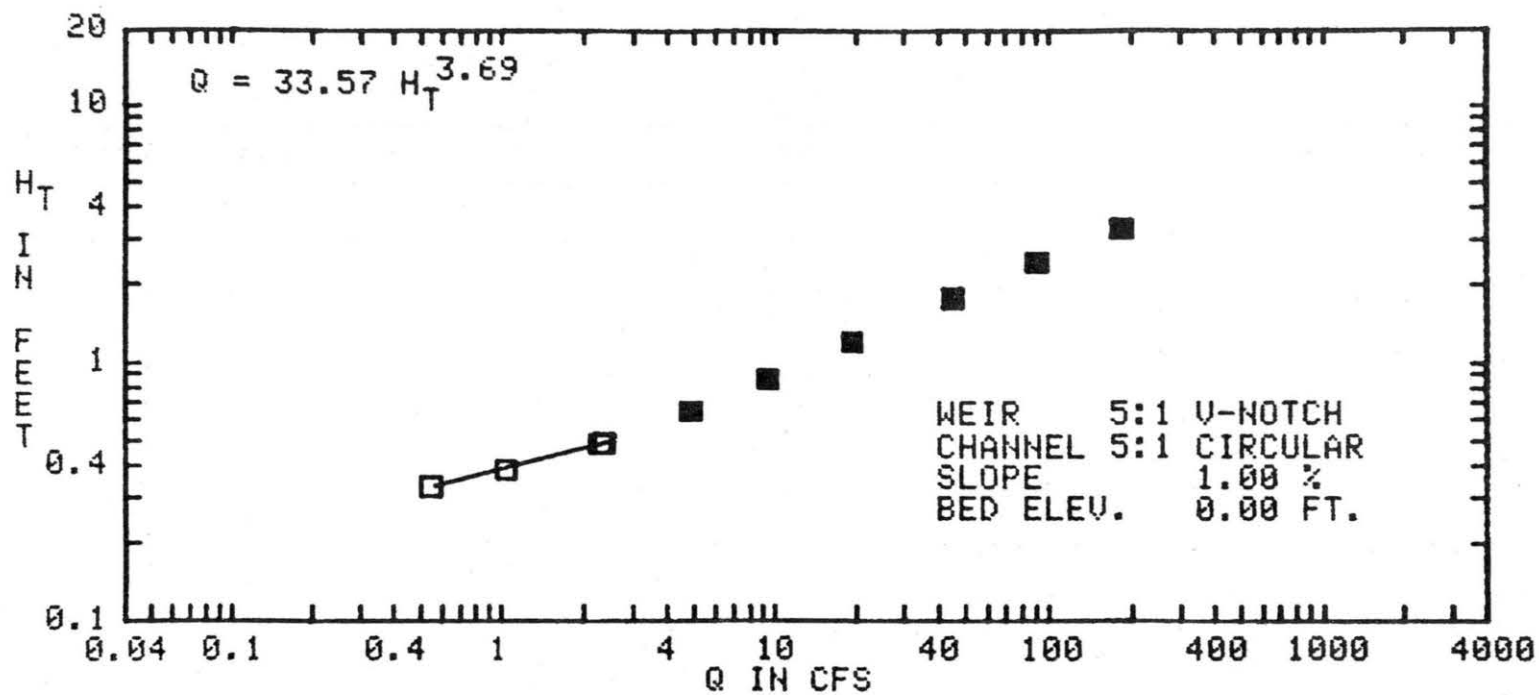

FIG. B-56 PLOT OF TOTAL HEAD versus DISCHARGE DATA POINTS

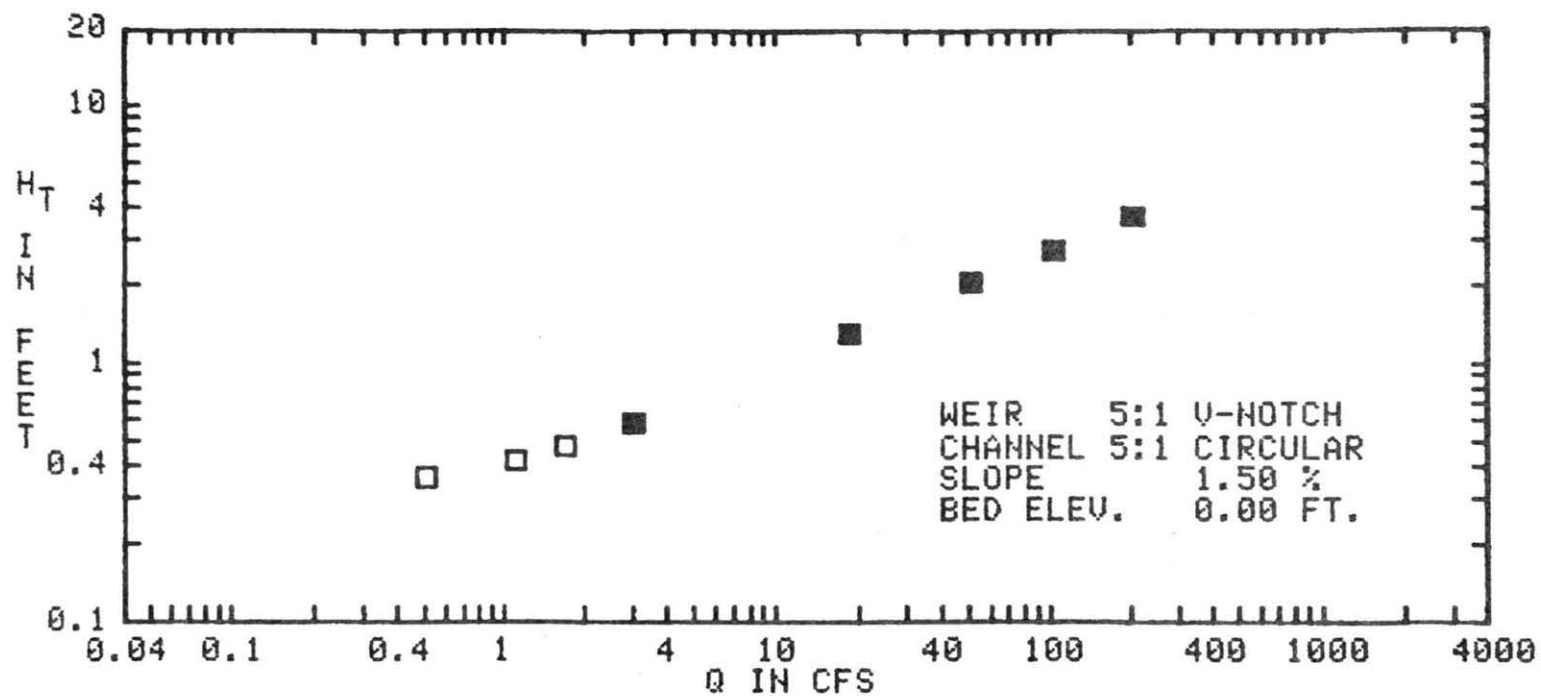

FIG. B-57 PLOT OF TOTAL HEAD versus DISCHARGE DATA POINTS

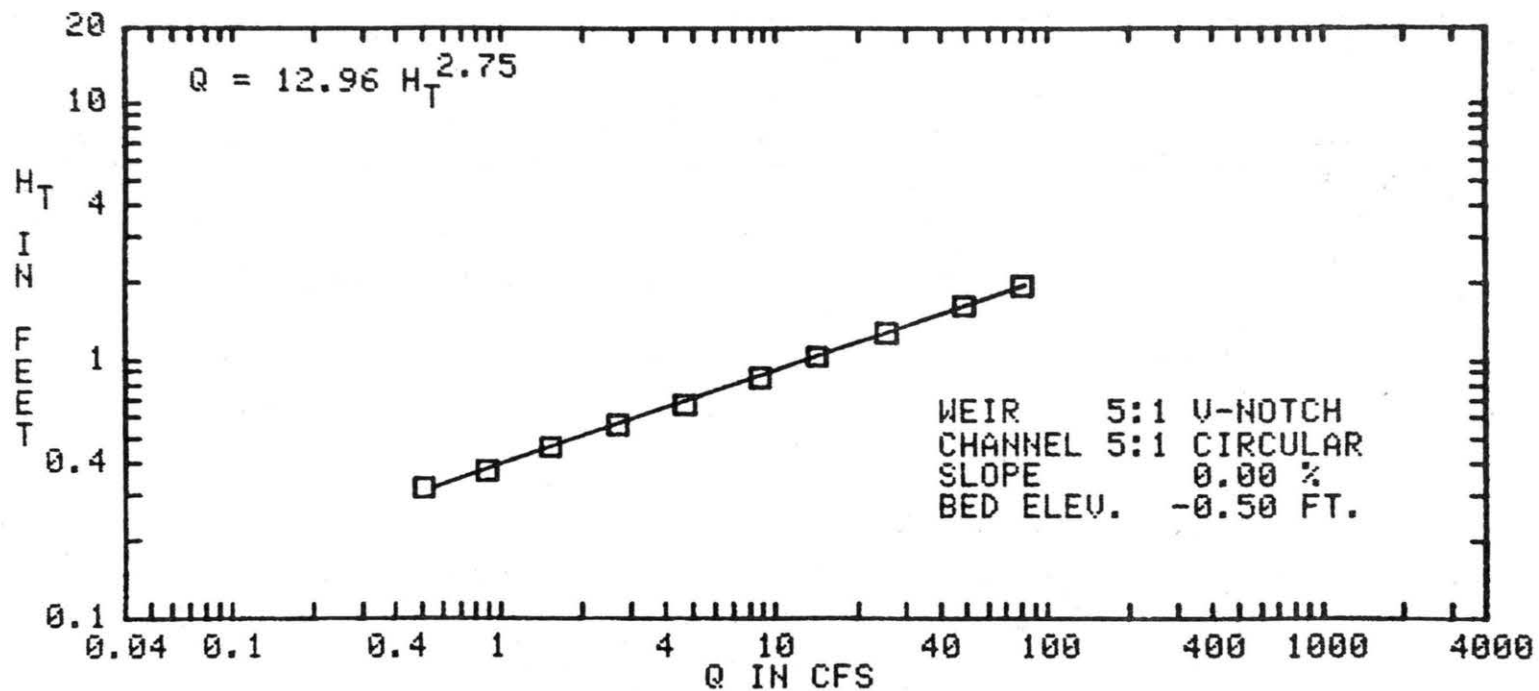

FIG. B-58 PLOT OF TOTAL HEAD versus DISCHARGE DATA POINTS

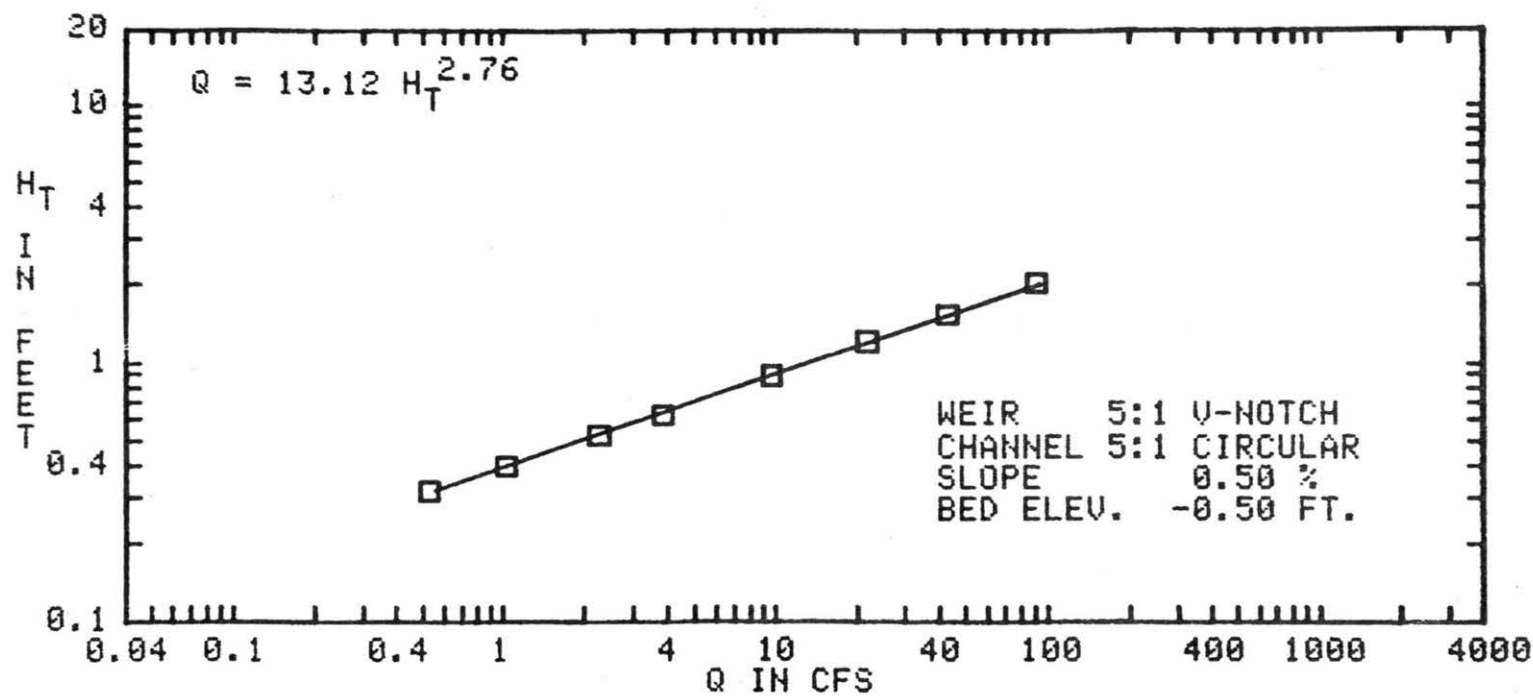

FIG. B-59 PLOT OF TOTAL HEAD versus DISCHARGE DATA POINTS

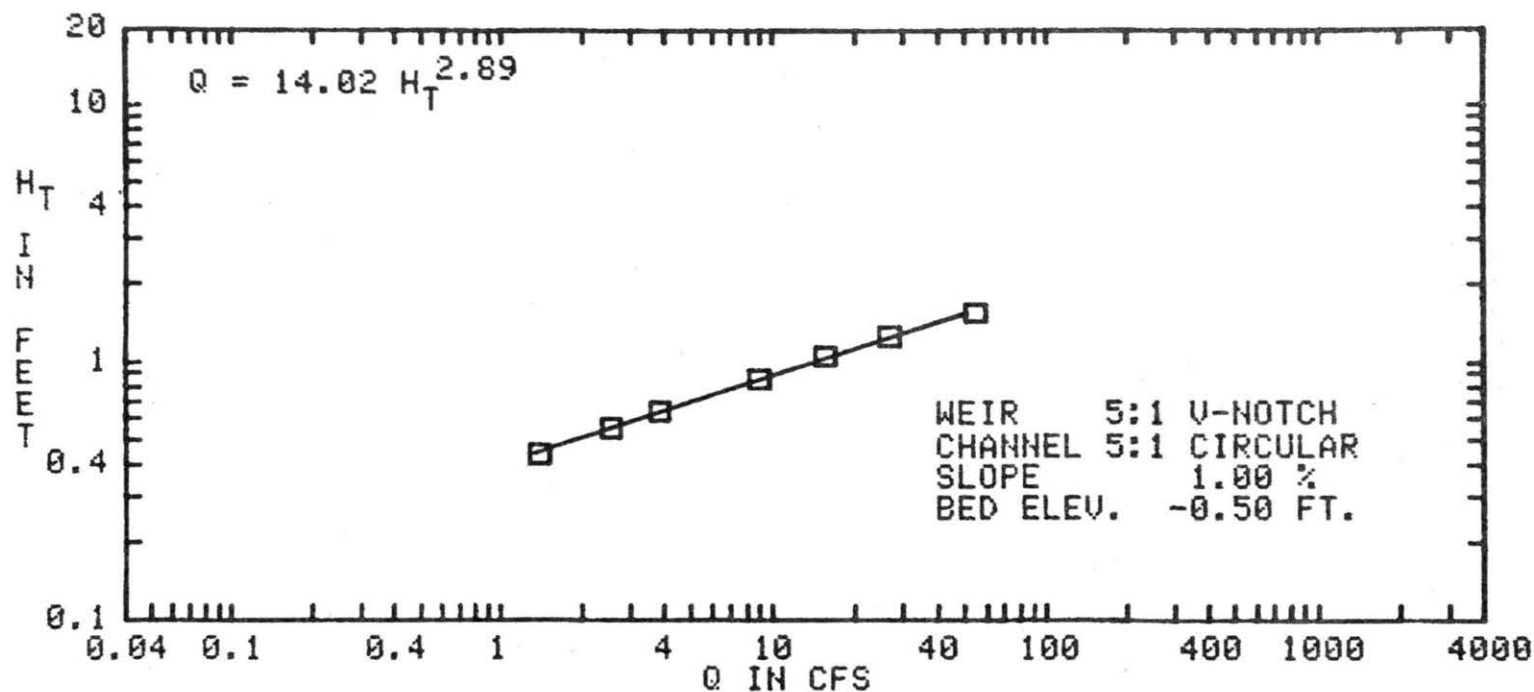

FIG. B-60 PLOT OF TOTAL HEAD versus DISCHARGE DATA POINTS

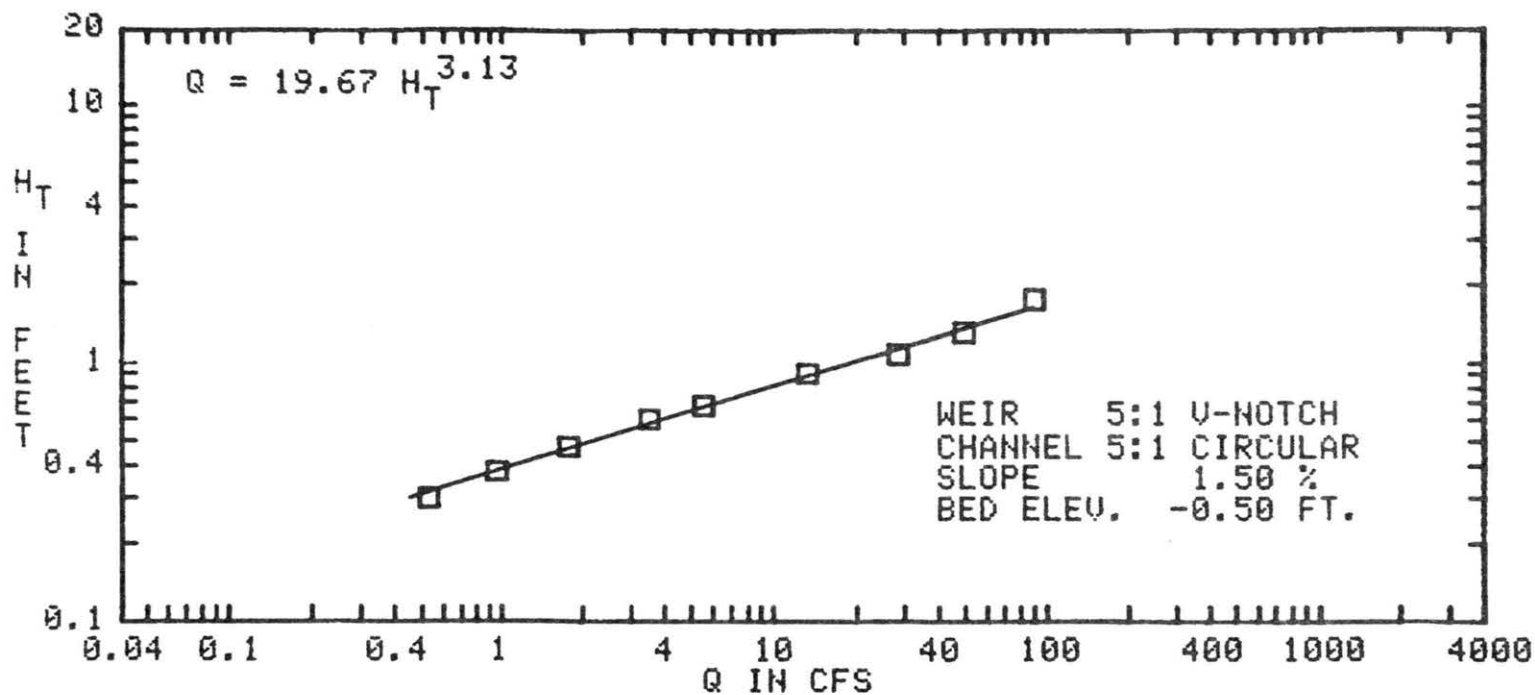

FIG. B-61 PLOT OF TOTAL HEAD versus DISCHARGE DATA POINTS

Appendix C

INDIVIDUAL TOTAL HEAD VS C_d DATA PLOTS

DISCHARGE COEFFICIENT CURVES, H_T VERSUS C_D

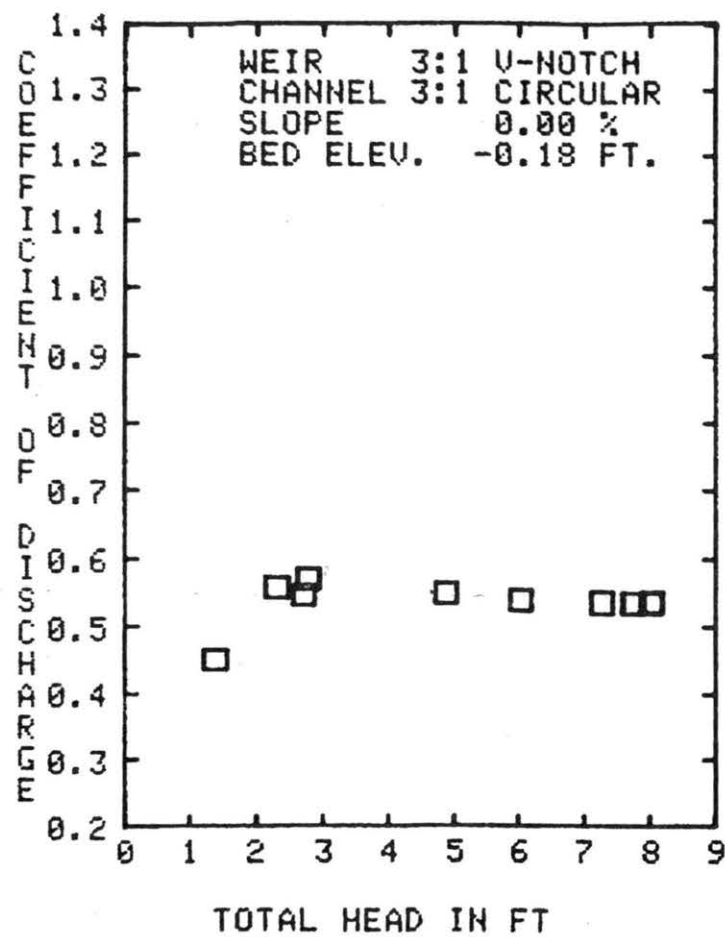

FIG. C-1

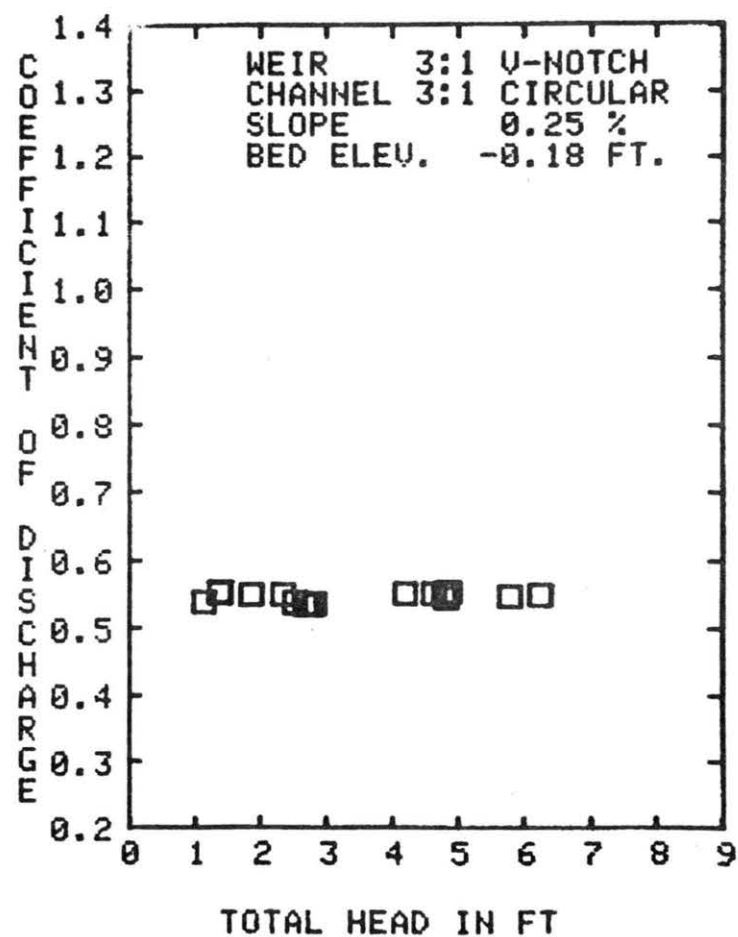

FIG. C-2

DISCHARGE COEFFICIENT CURVES, H_T VERSUS C_D

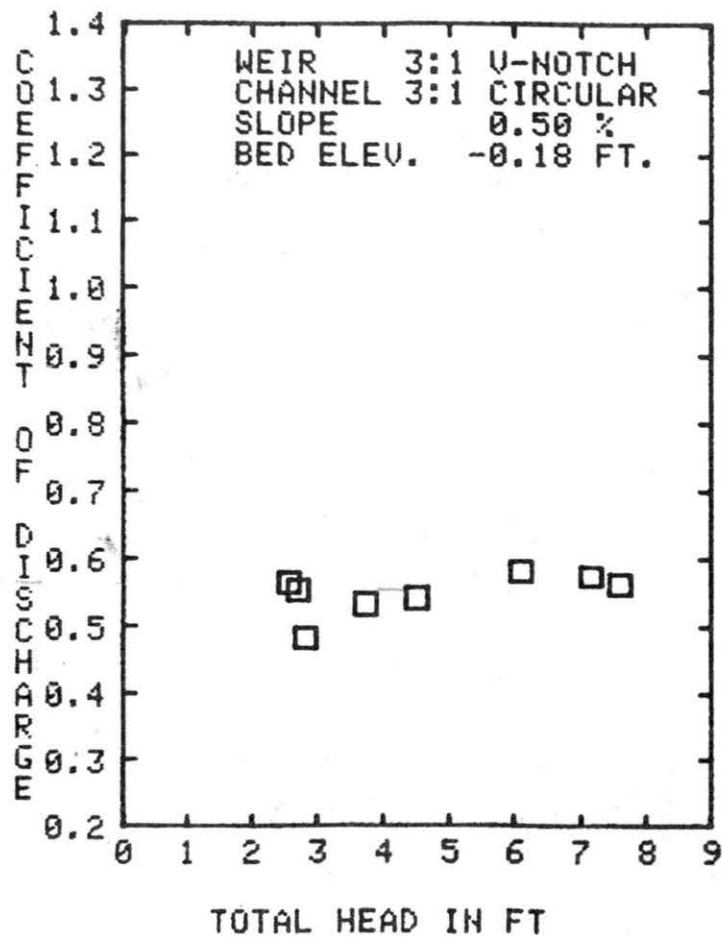

FIG. C-3

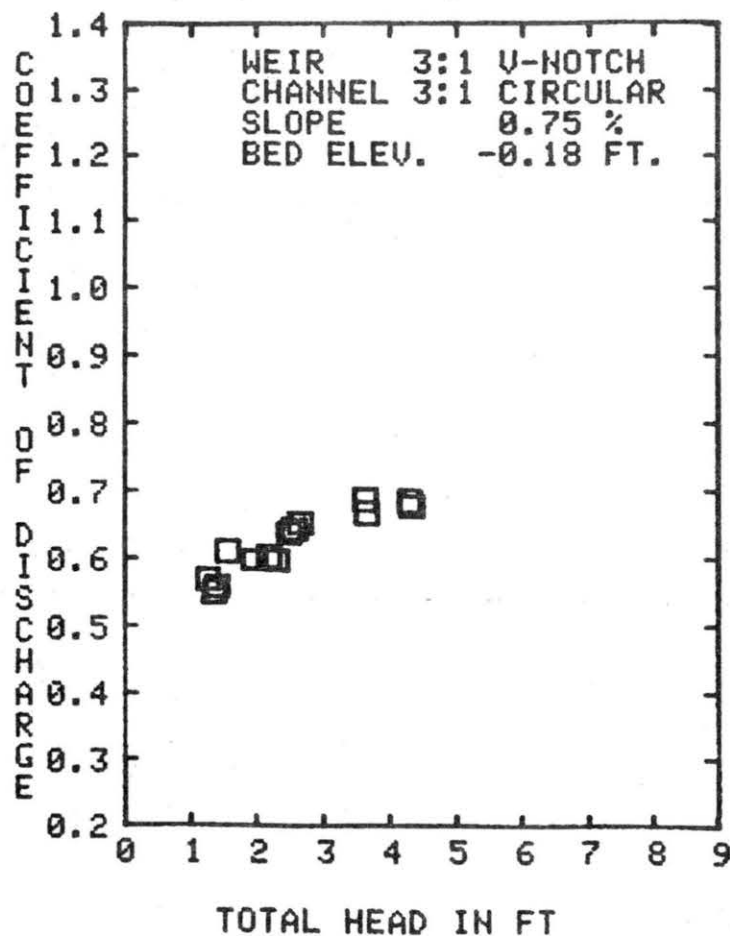

FIG. C-4

DISCHARGE COEFFICIENT CURVES, H_T VERSUS C_D

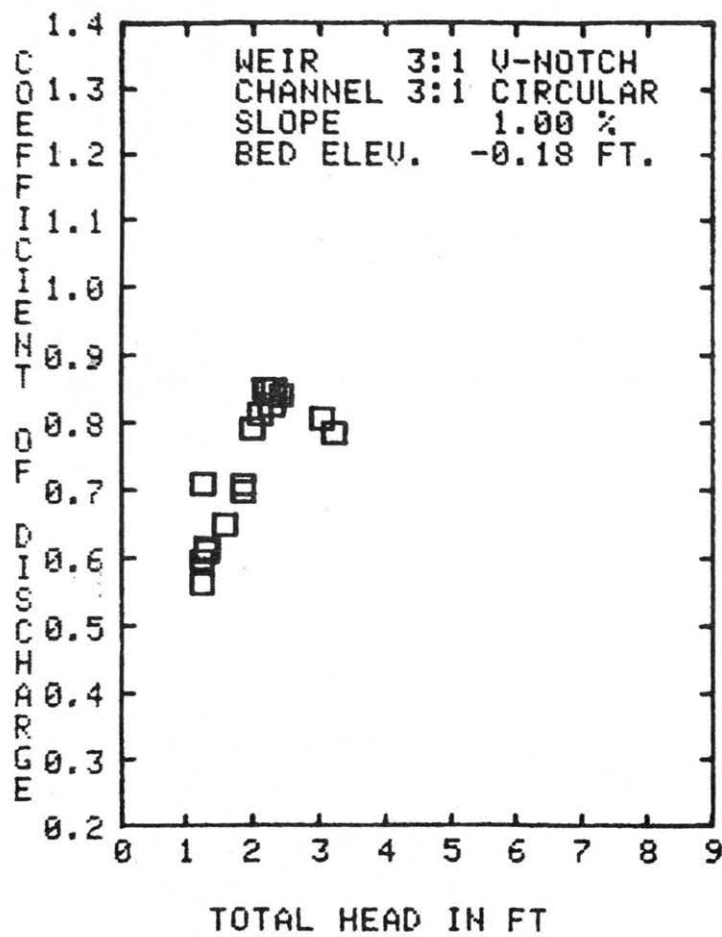

FIG. C-5

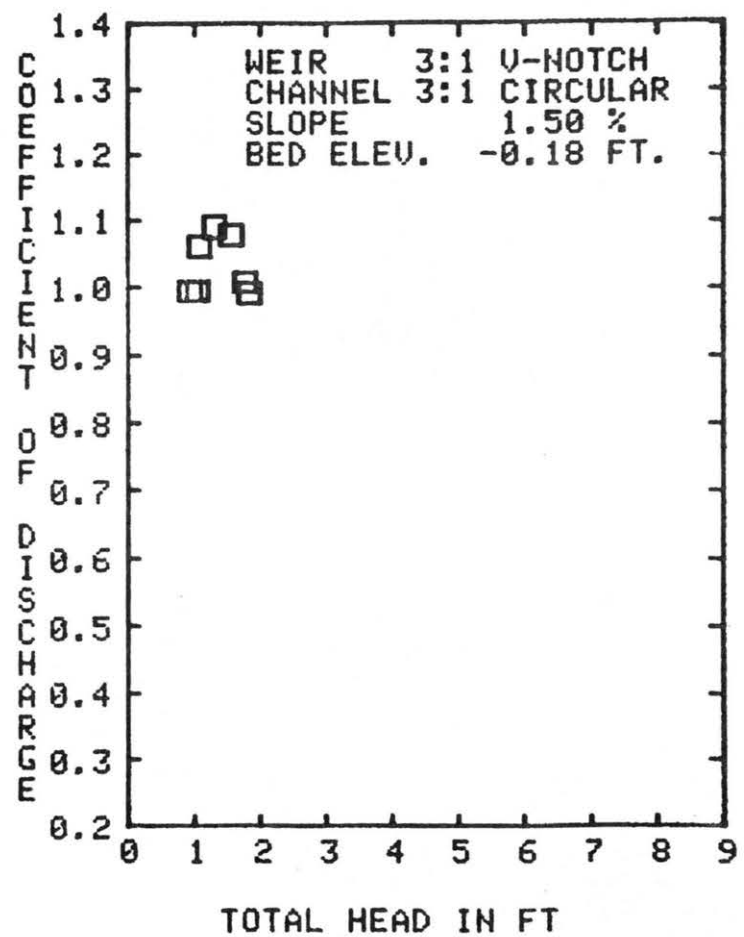

FIG. C-6

DISCHARGE COEFFICIENT CURVES, H_T VERSUS C_D

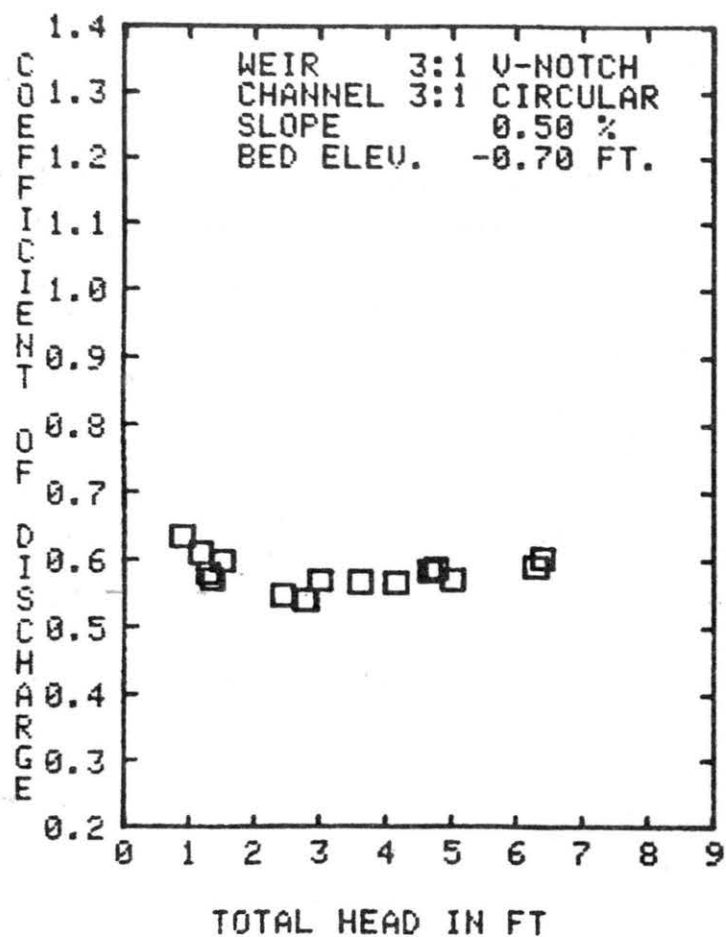

FIG. C-7

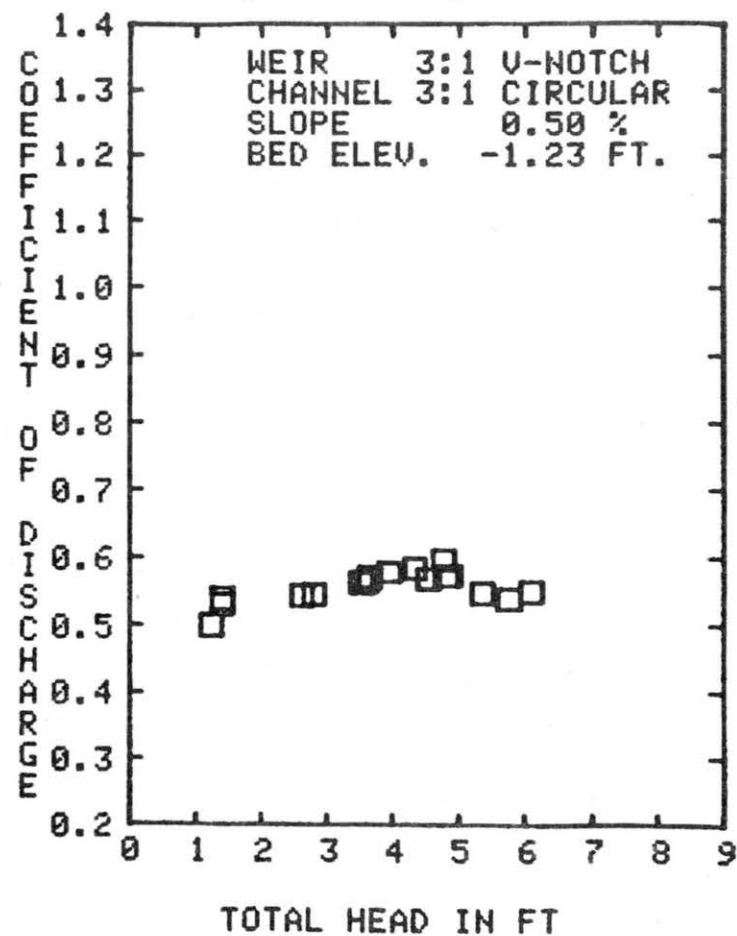

FIG. C-8

DISCHARGE COEFFICIENT CURVES, H_T VERSUS C_D

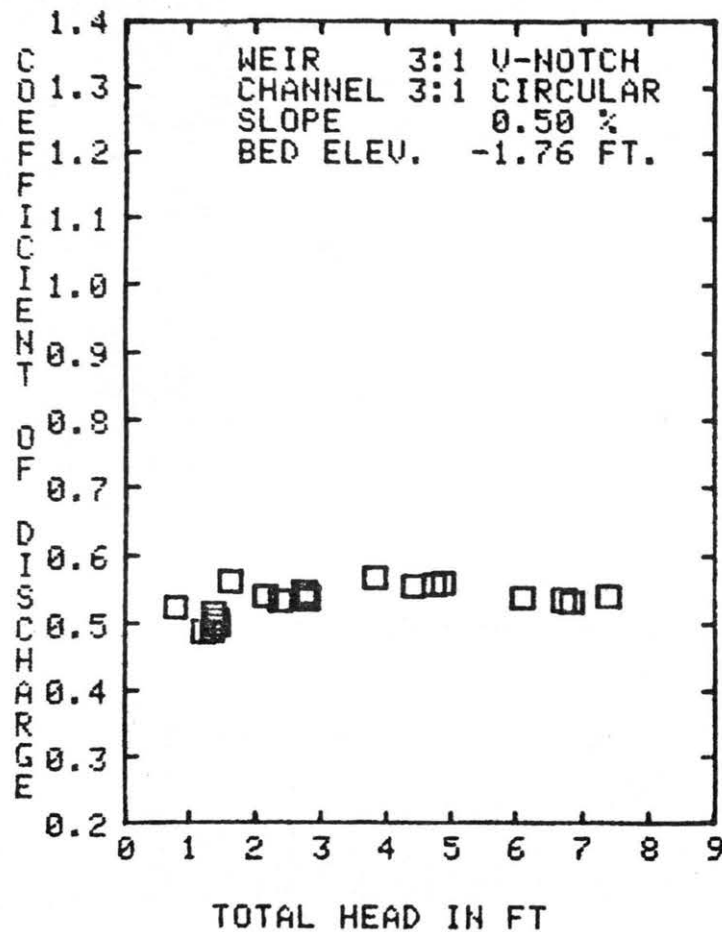

FIG. C-9

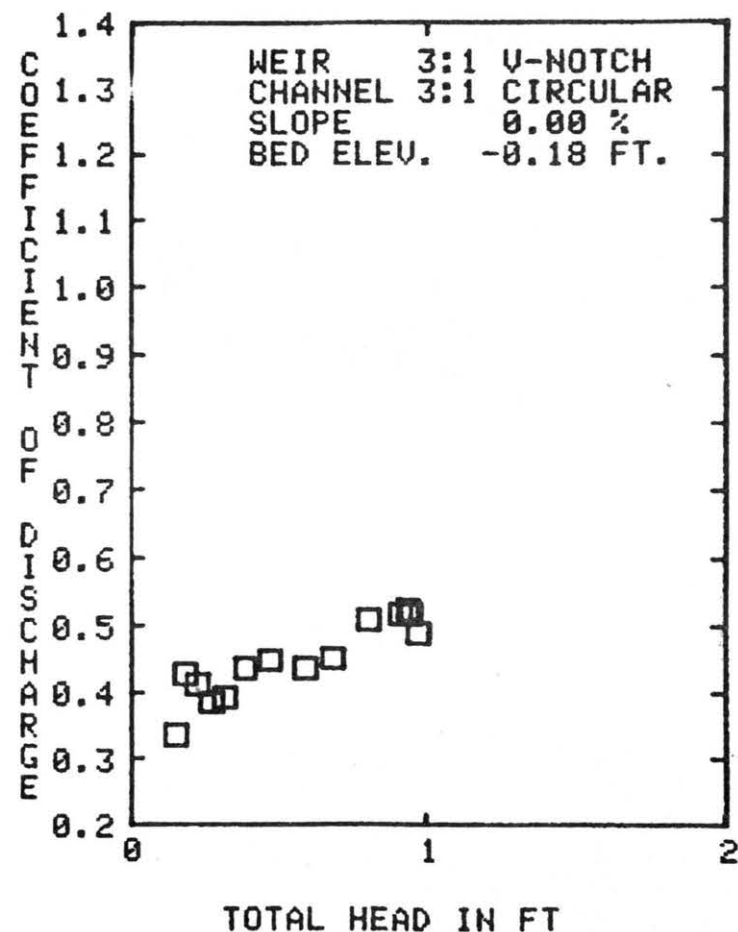
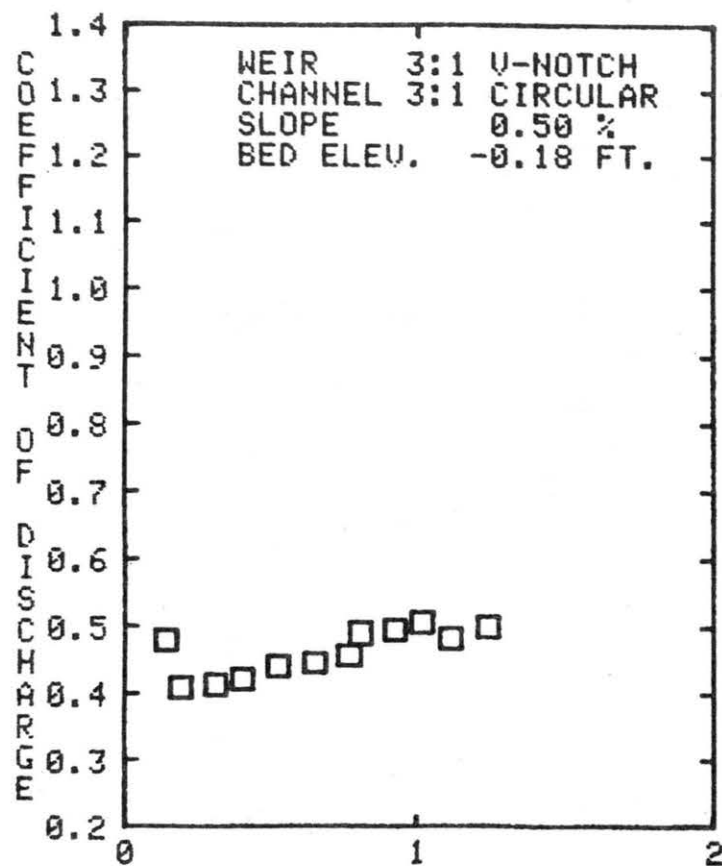

FIG. C-10

DISCHARGE COEFFICIENT CURVES, H_T VERSUS C_D



TOTAL HEAD IN FT

FIG. C-11

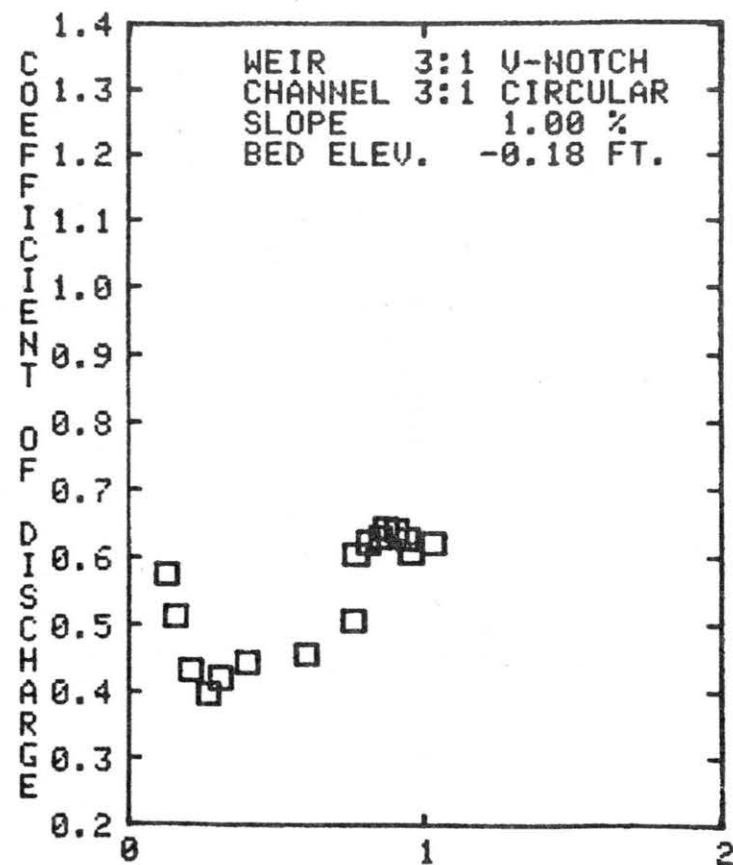

TOTAL HEAD IN FT

FIG. C-12

DISCHARGE COEFFICIENT CURVES, H_T VERSUS C_D

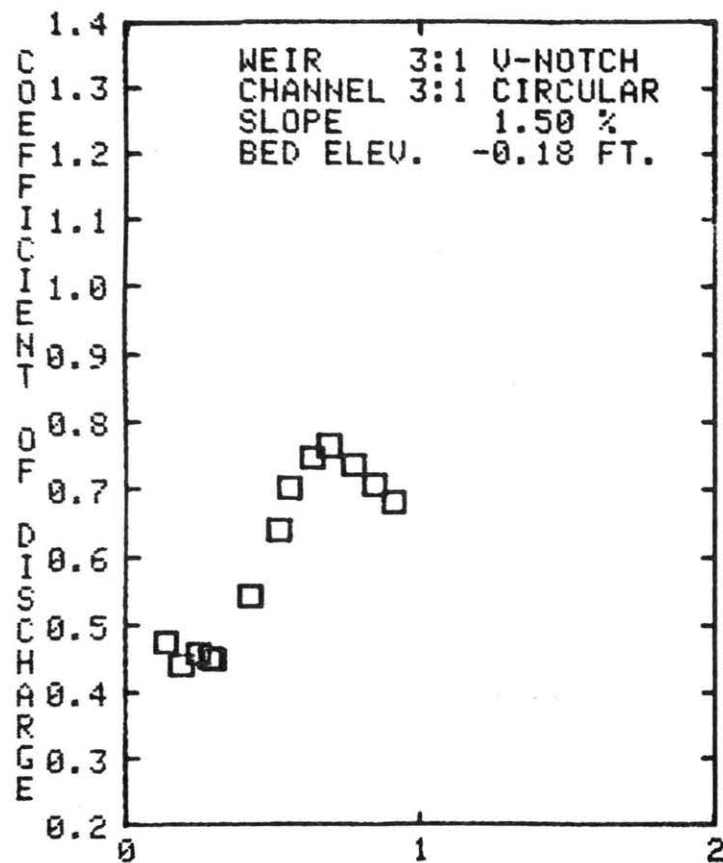

TOTAL HEAD IN FT

FIG. C-13

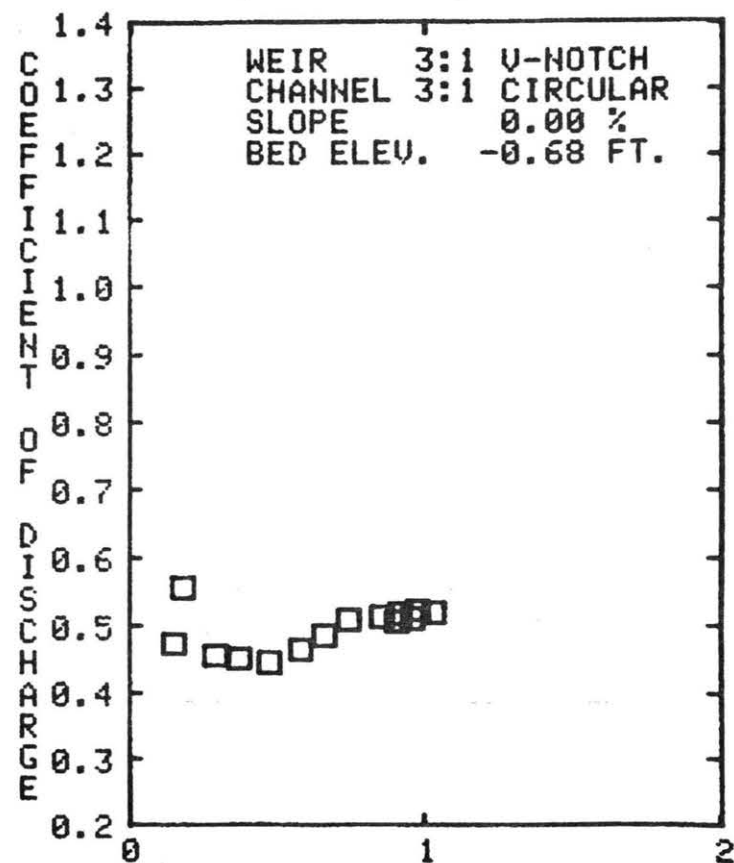

TOTAL HEAD IN FT

FIG. C-14

DISCHARGE COEFFICIENT CURVES, H_T VERSUS C_D

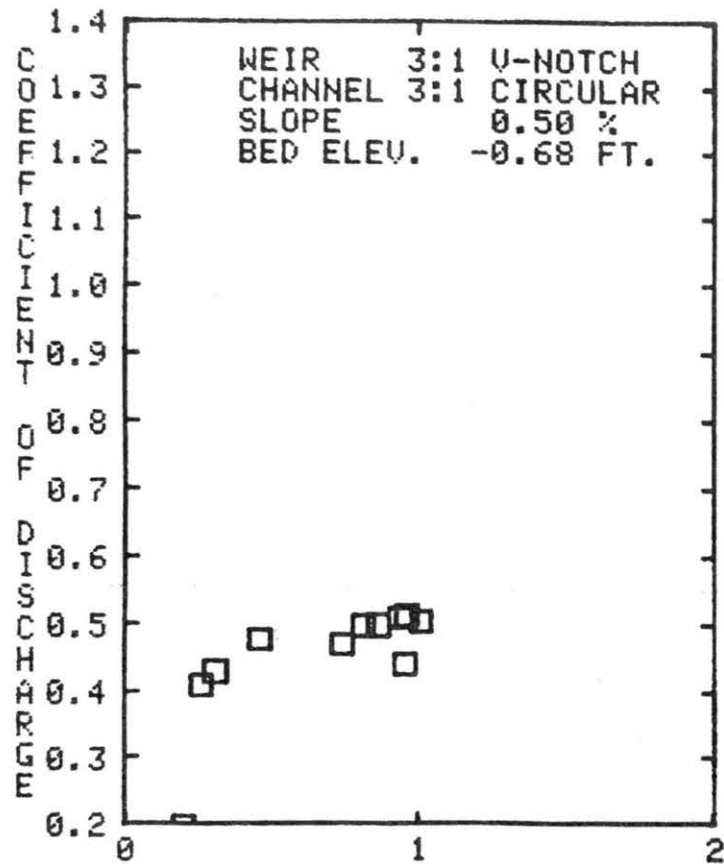

TOTAL HEAD IN FT

FIG. C-15

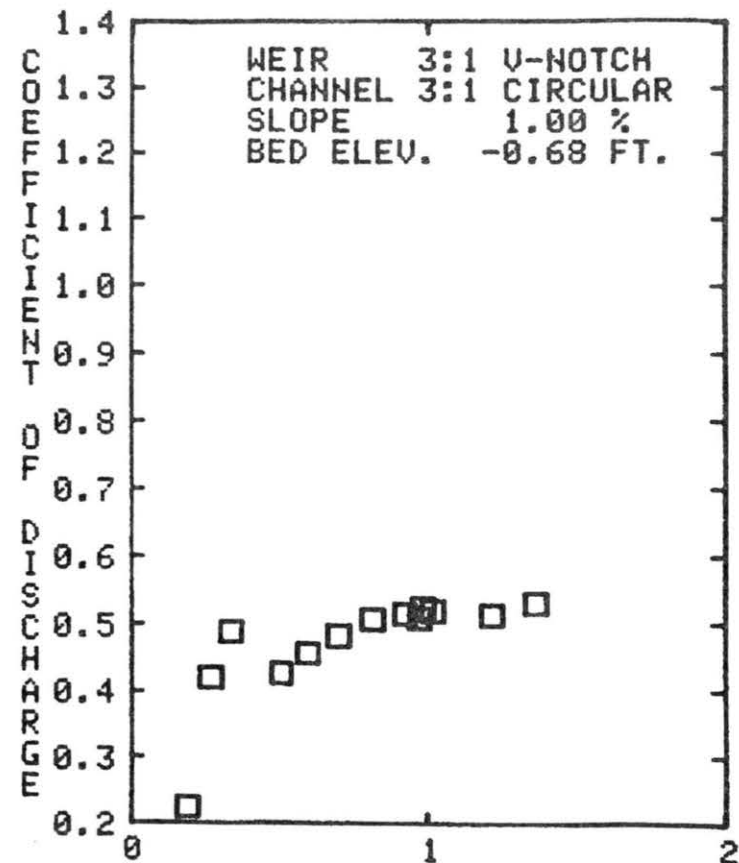

TOTAL HEAD IN FT

FIG. C-16

DISCHARGE COEFFICIENT CURVES, H_T VERSUS C_D

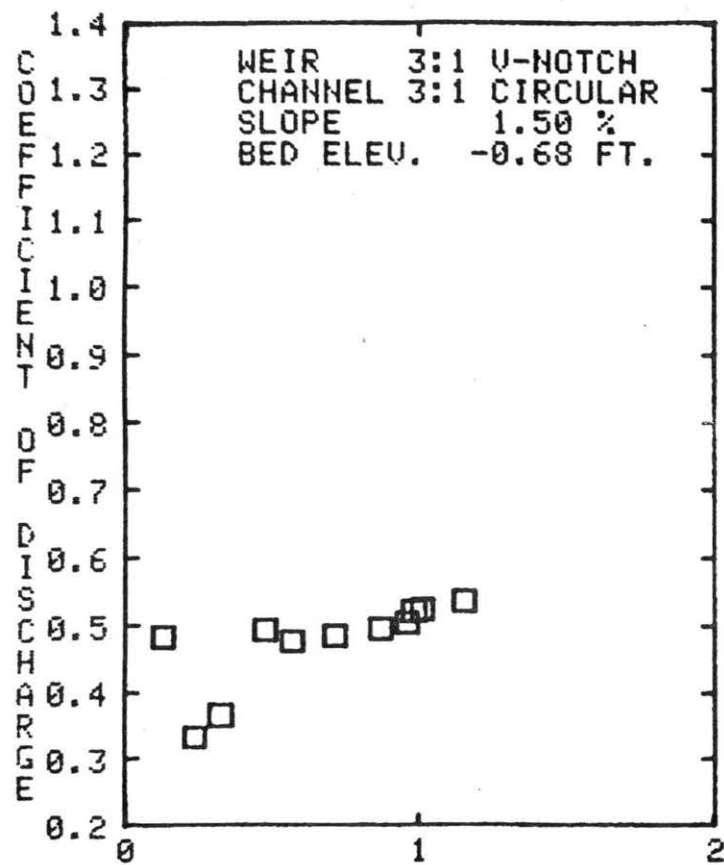

TOTAL HEAD IN FT

FIG. C-17

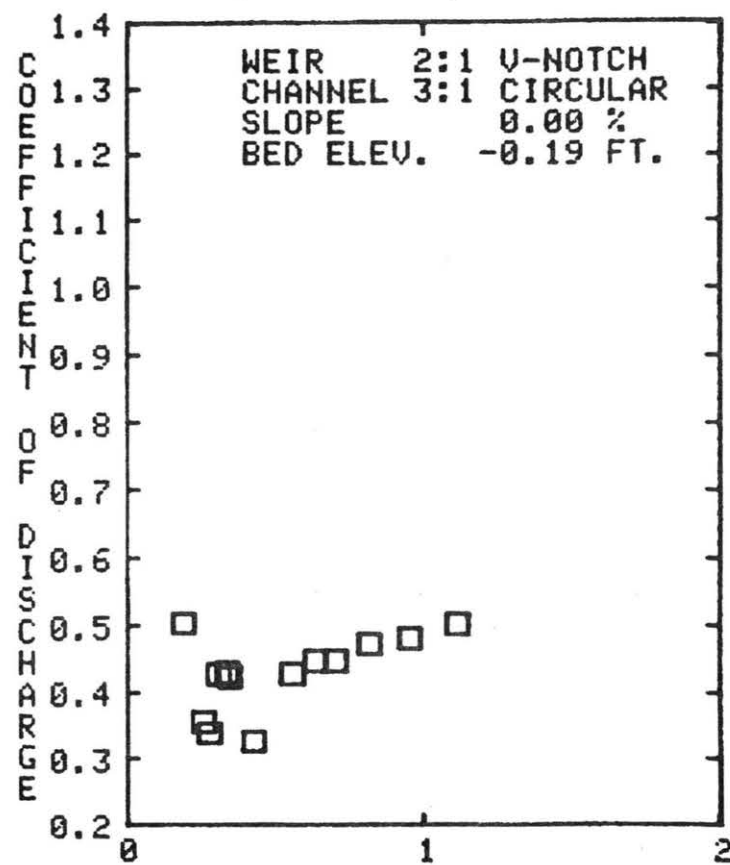

TOTAL HEAD IN FT

FIG. C-18

DISCHARGE COEFFICIENT CURVES, H_T VERSUS C_D

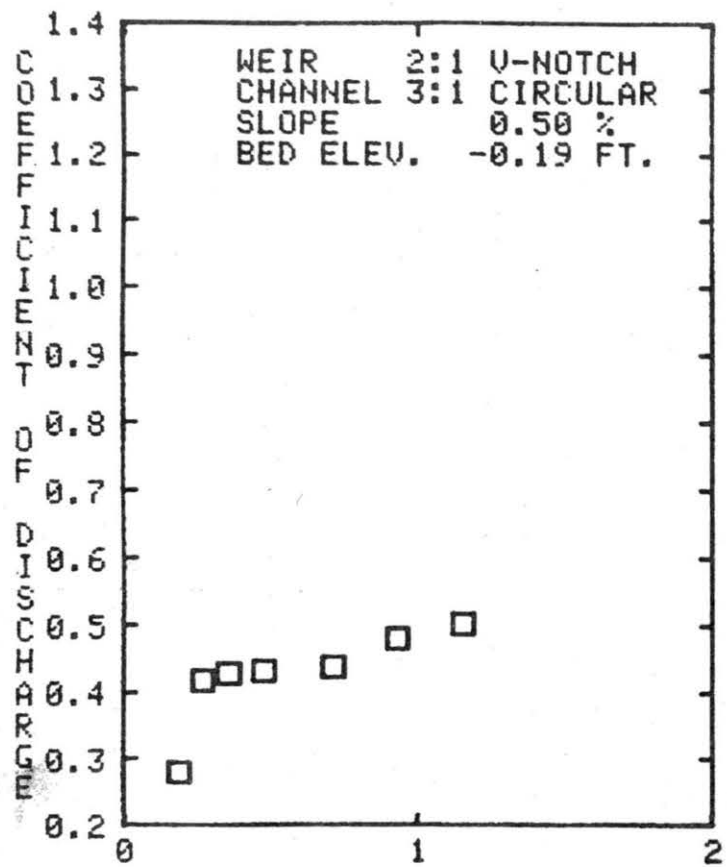

TOTAL HEAD IN FT

FIG. C-19

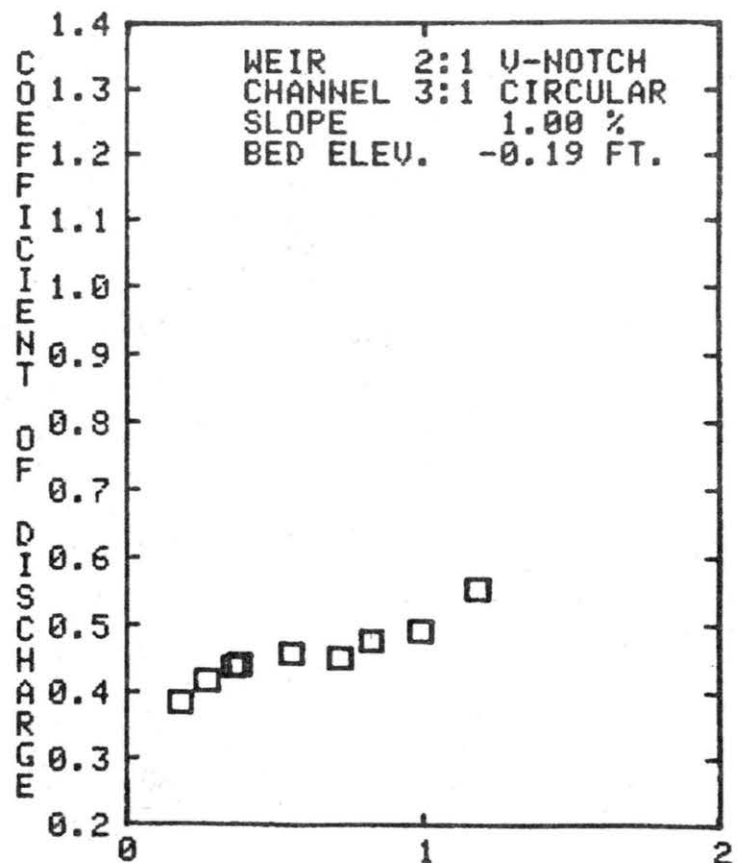

TOTAL HEAD IN FT

FIG. C-20

DISCHARGE COEFFICIENT CURVES, H_T VERSUS C_D

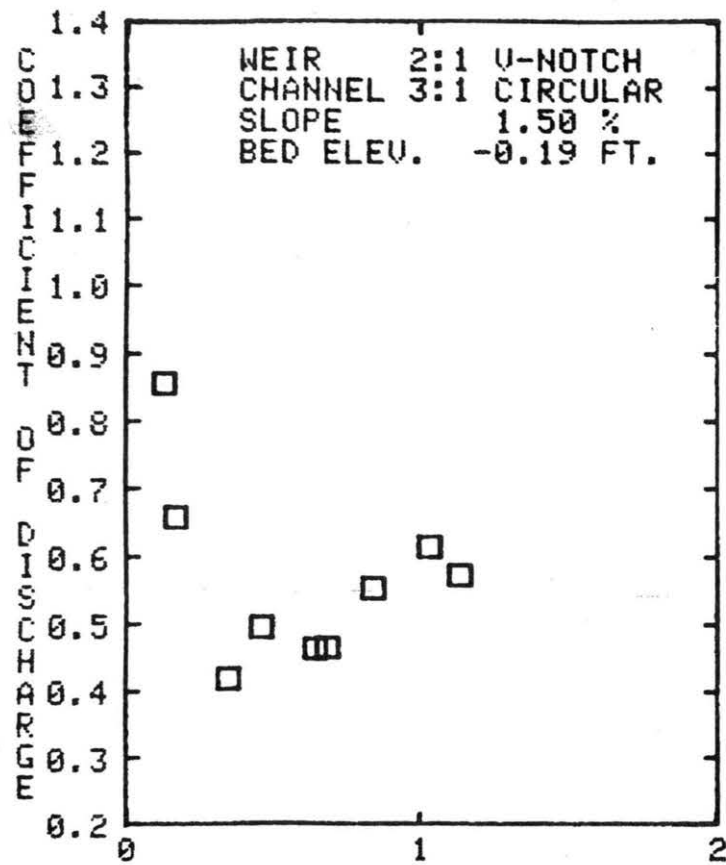

TOTAL HEAD IN FT

FIG. C-21

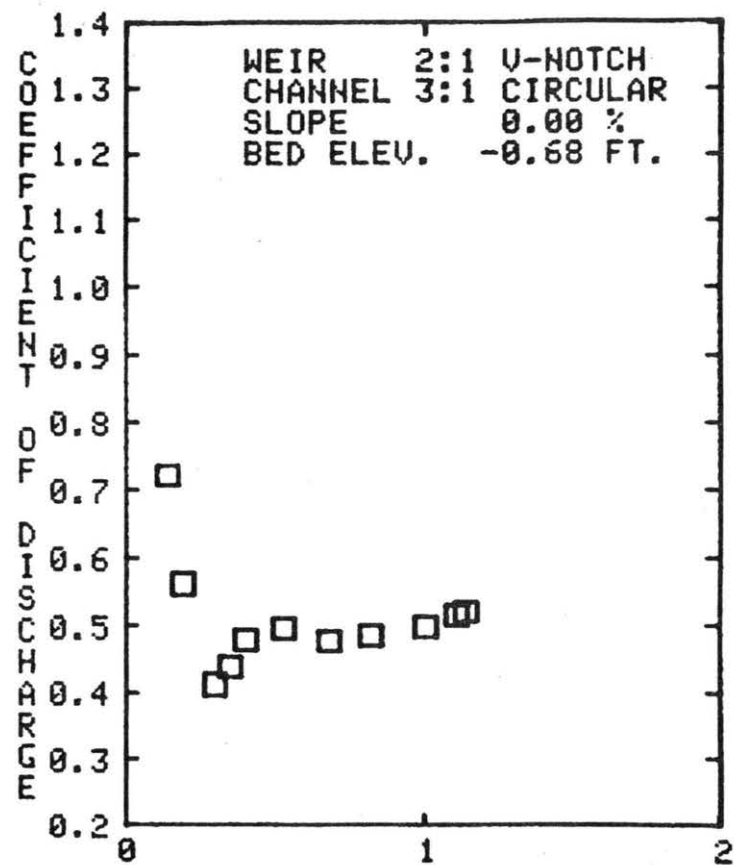

TOTAL HEAD IN FT

FIG. C-22

DISCHARGE COEFFICIENT CURVES, H_T VERSUS C_D

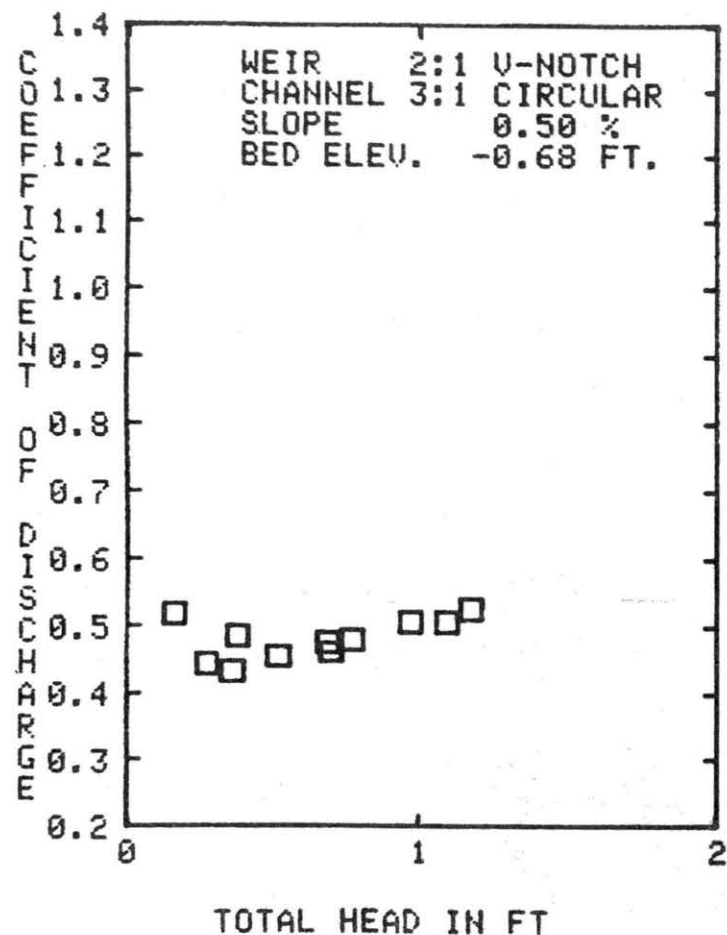

FIG. C-23

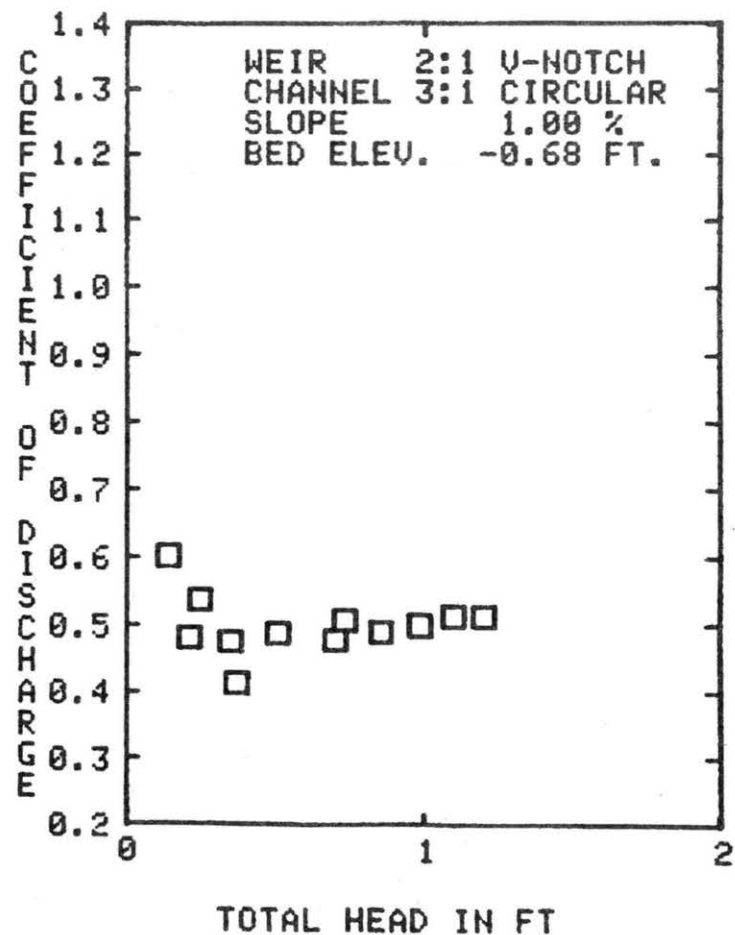
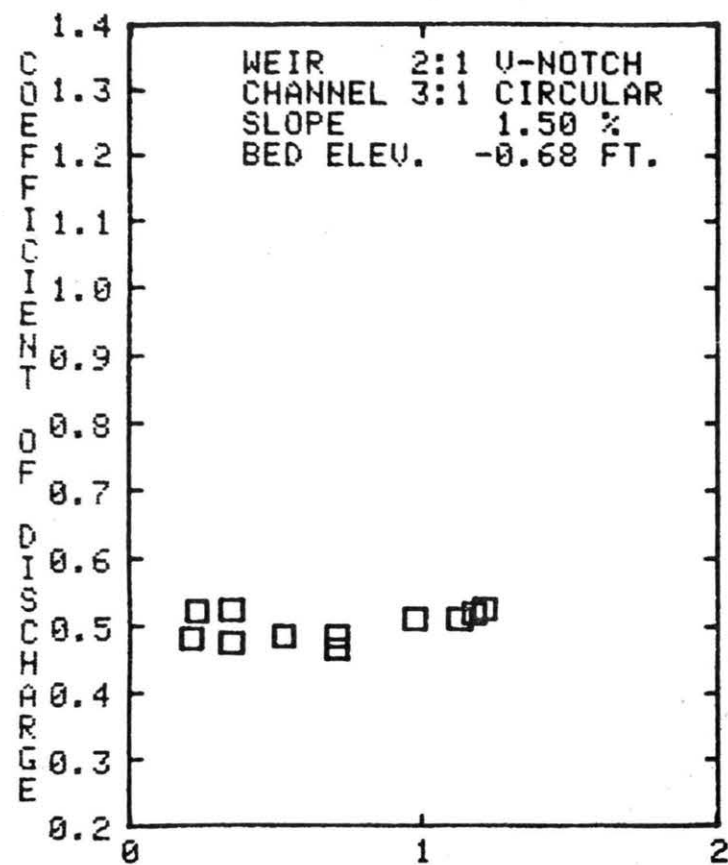

FIG. C-24

DISCHARGE COEFFICIENT CURVES, H_T VERSUS C_D



TOTAL HEAD IN FT

FIG. C-25

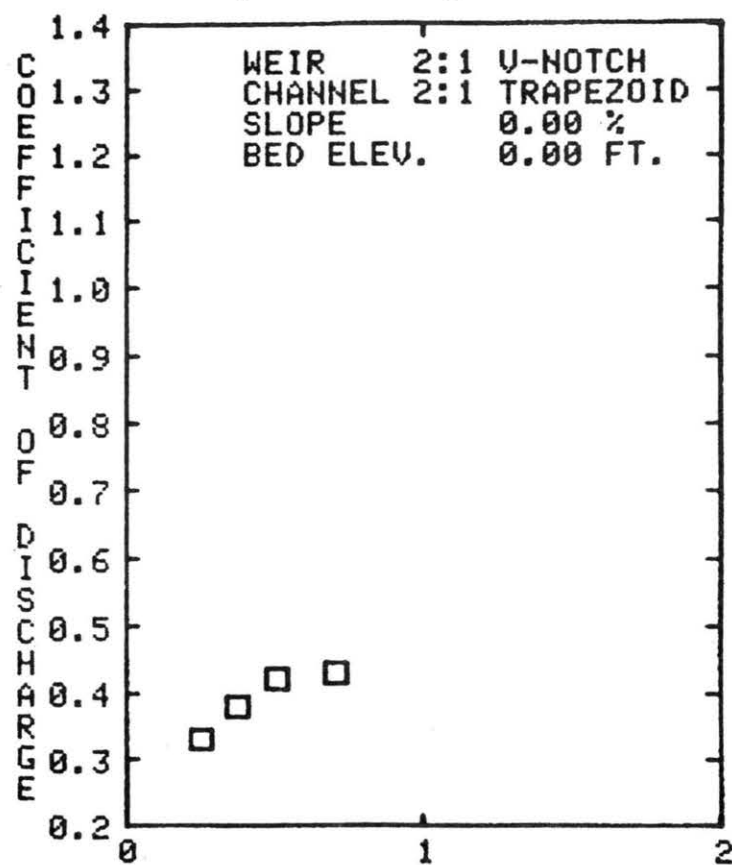

TOTAL HEAD IN FT

FIG. C-26

DISCHARGE COEFFICIENT CURVES, H_T VERSUS C_D

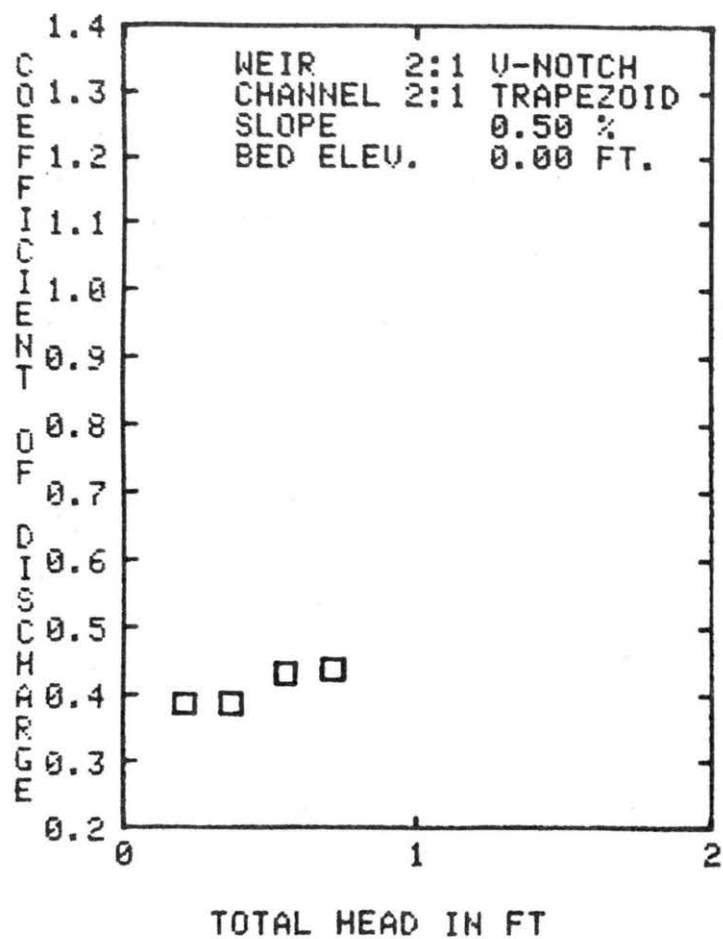

FIG. C-27

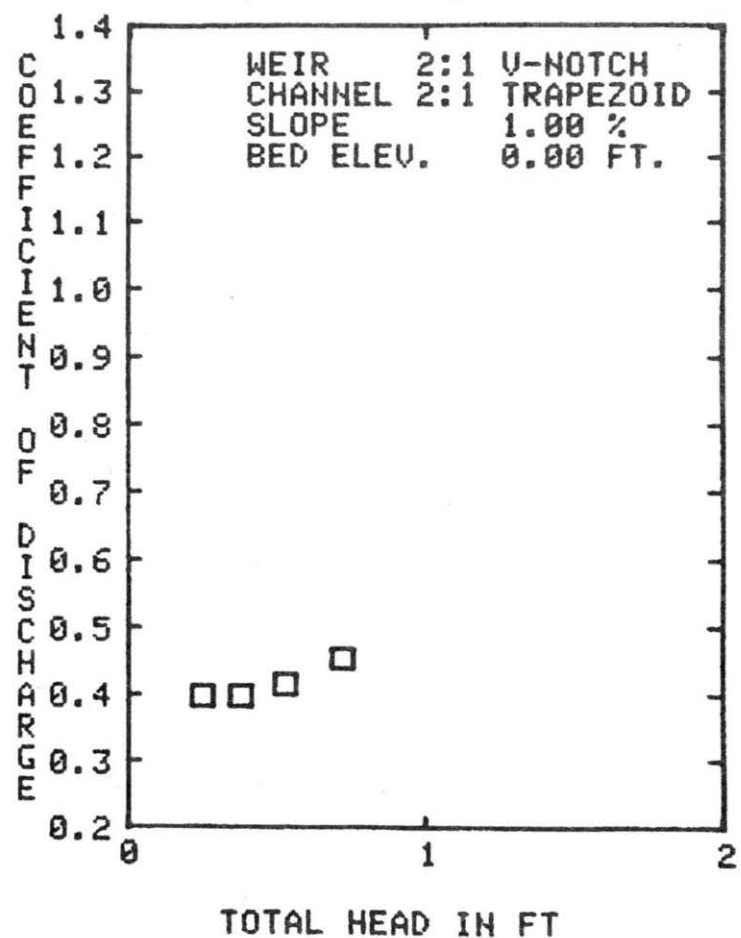

FIG. C-28

DISCHARGE COEFFICIENT CURVES, H_T VERSUS C_D

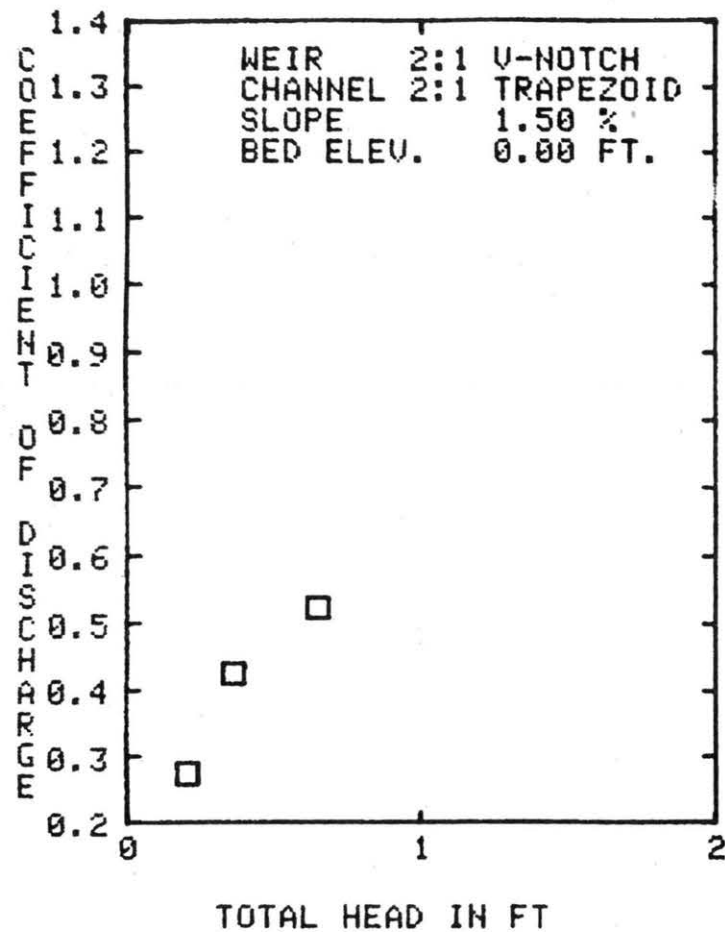

FIG. C-29

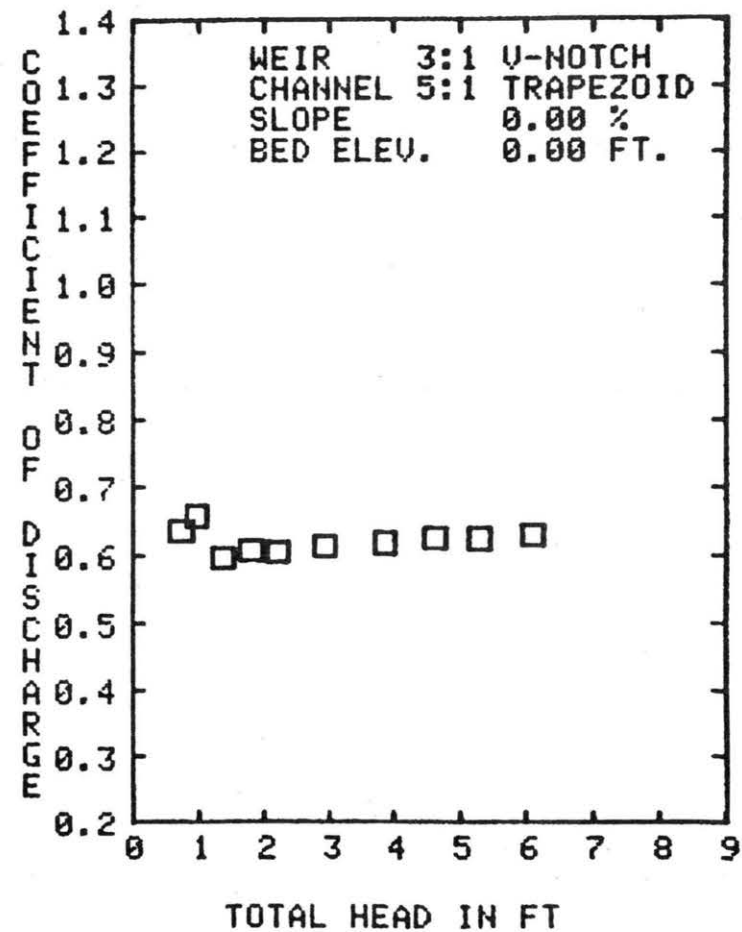
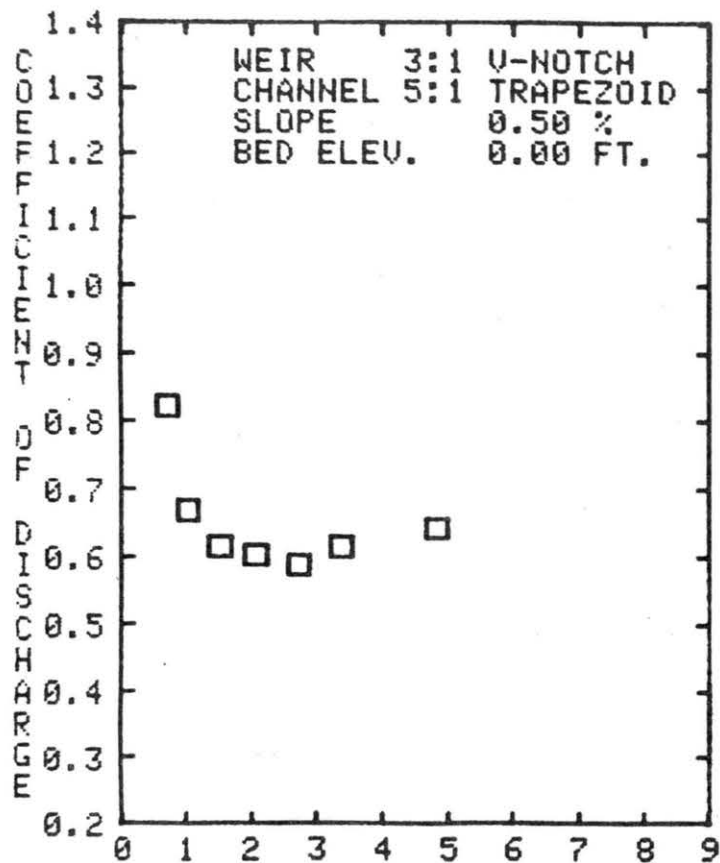

FIG. C-30

DISCHARGE COEFFICIENT CURVES, H_T VERSUS C_D



TOTAL HEAD IN FT

FIG. C-31

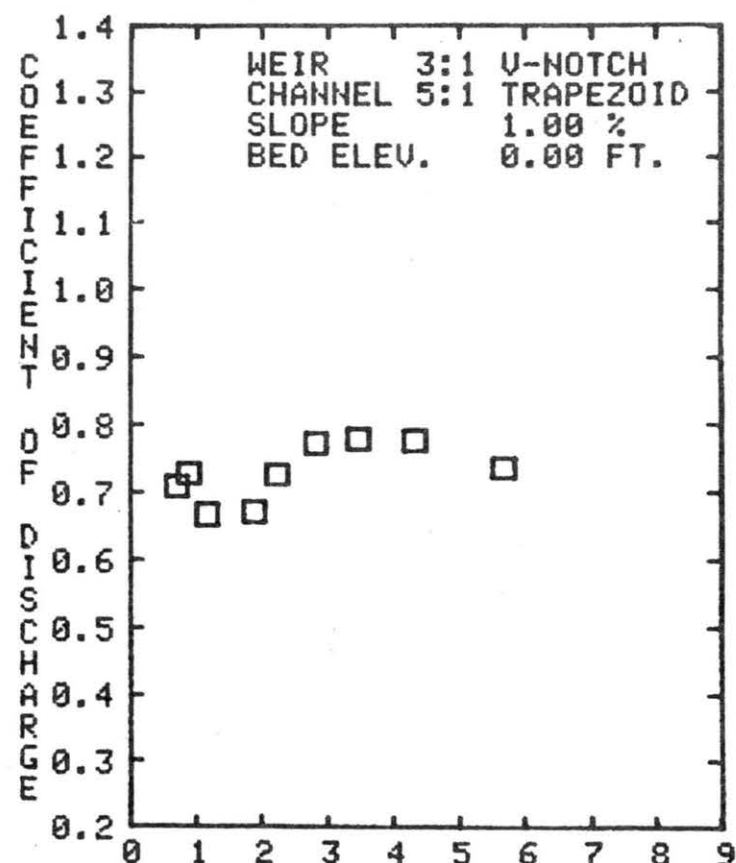

TOTAL HEAD IN FT

FIG. C-32

DISCHARGE COEFFICIENT CURVES, H_T VERSUS C_D

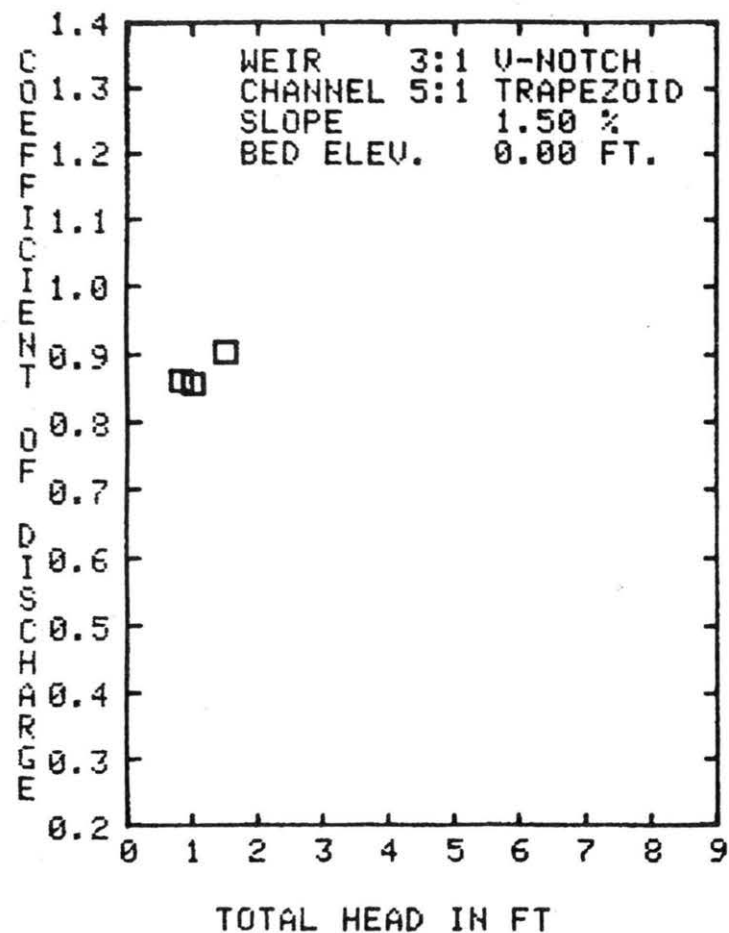

FIG. C-33

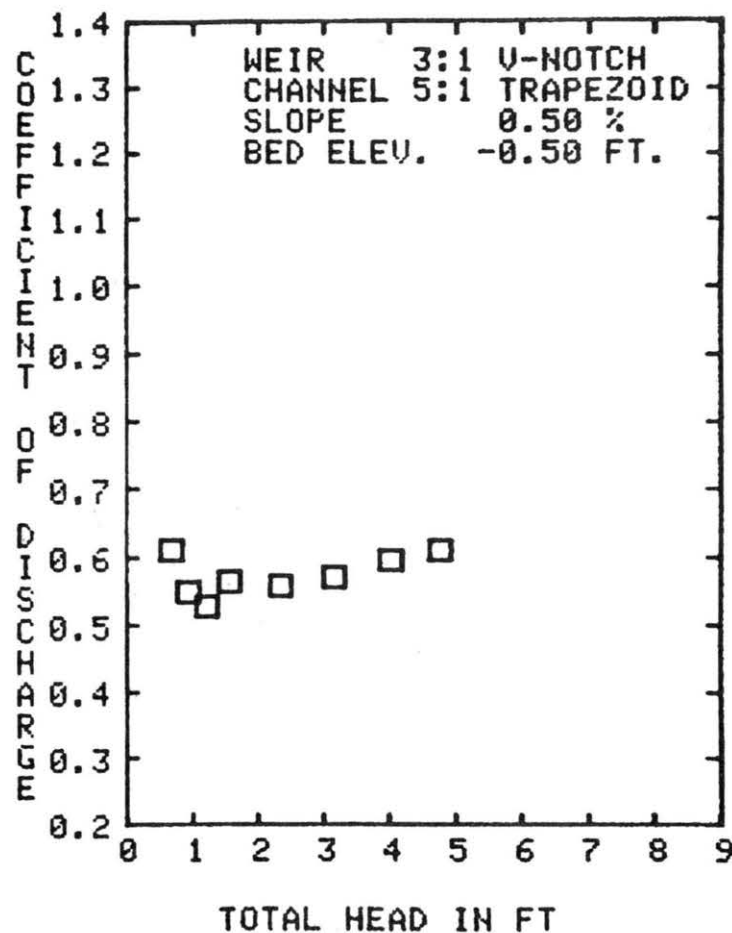

FIG. C-34

DISCHARGE COEFFICIENT CURVES, H_T VERSUS C_D

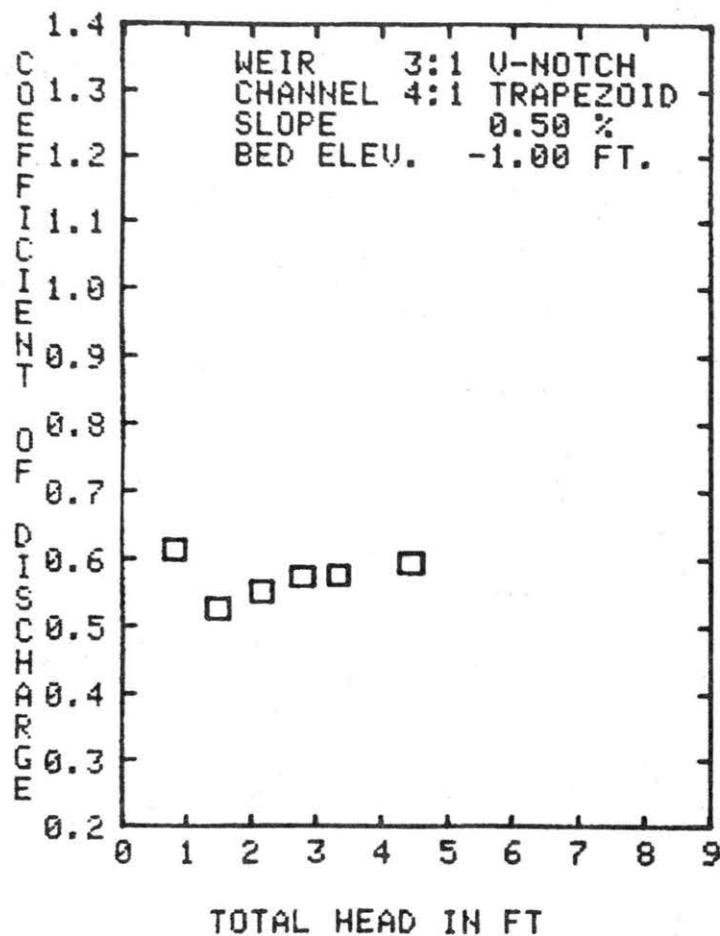

FIG. C-35

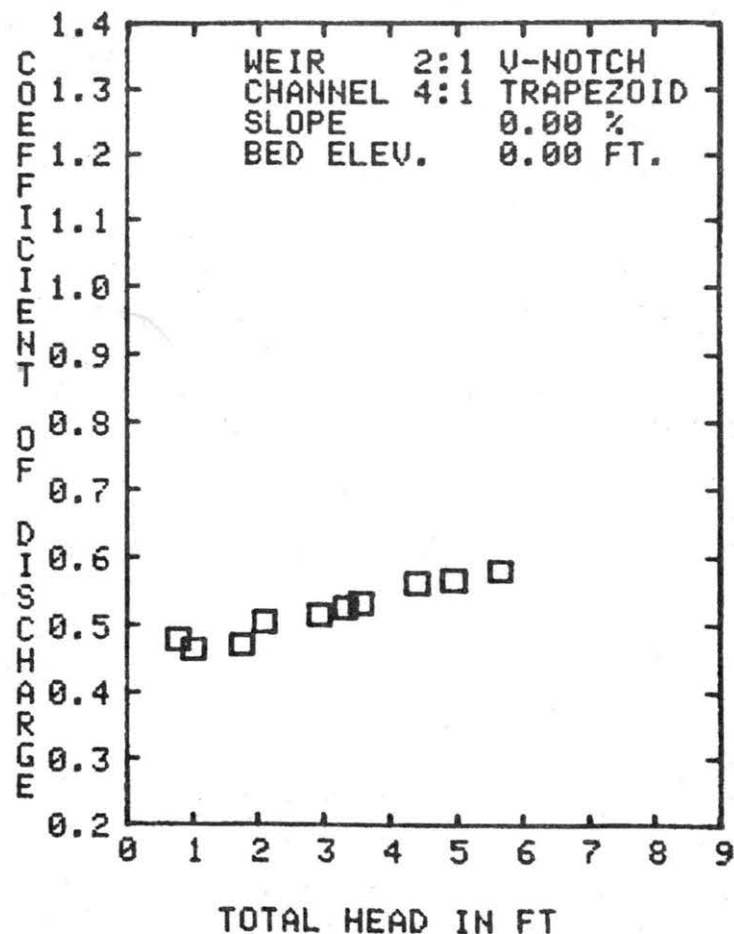

FIG. C-36

DISCHARGE COEFFICIENT CURVES, H_T VERSUS C_D

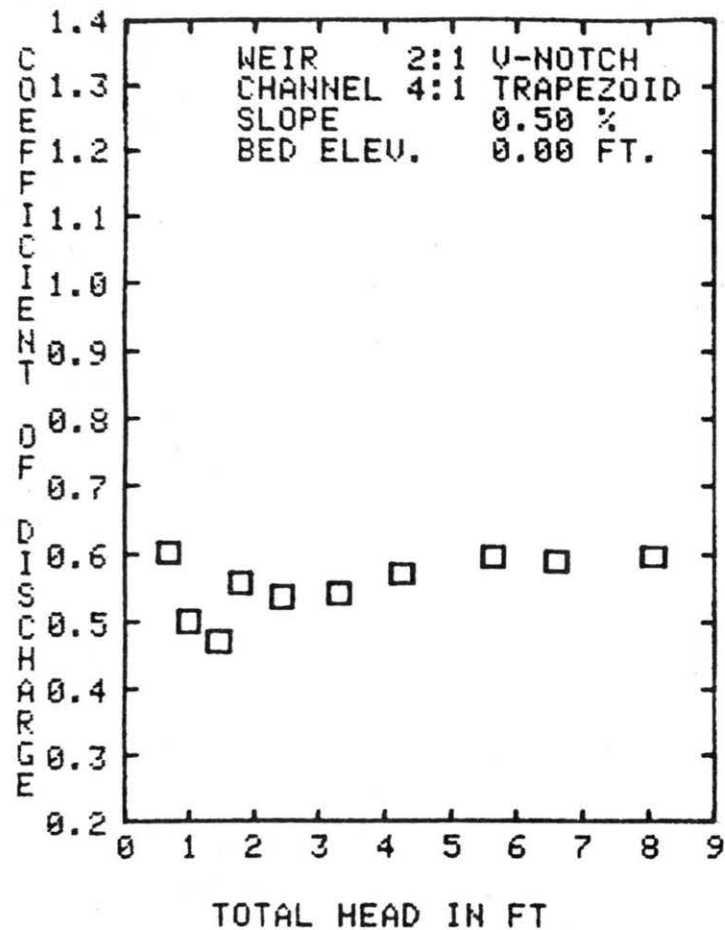

FIG. C-37

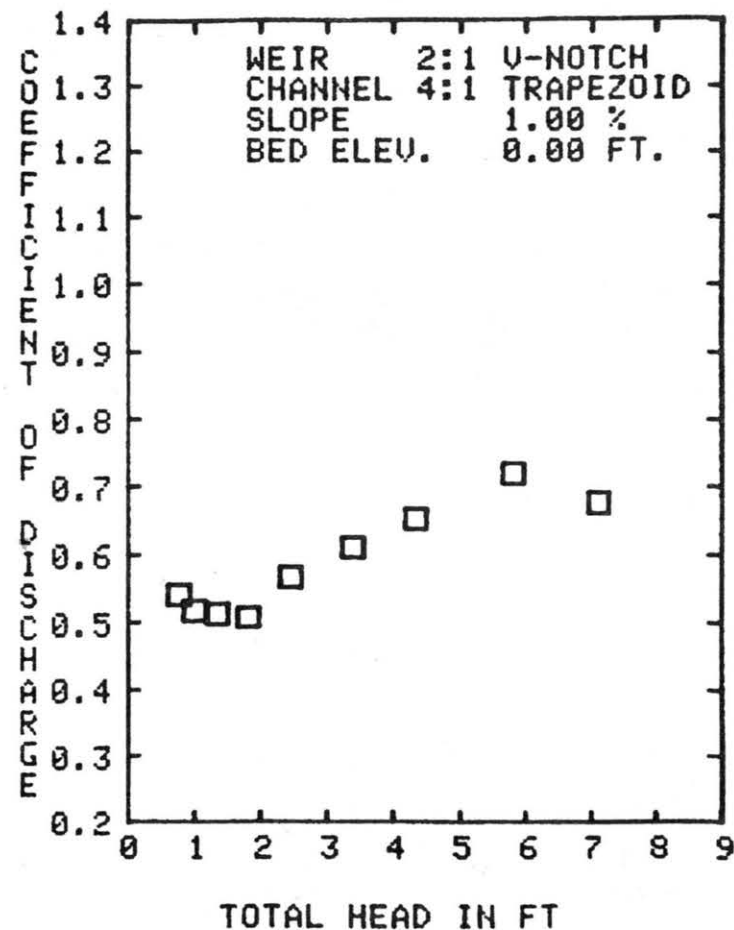

FIG. C-38

DISCHARGE COEFFICIENT CURVES, H_T VERSUS C_D

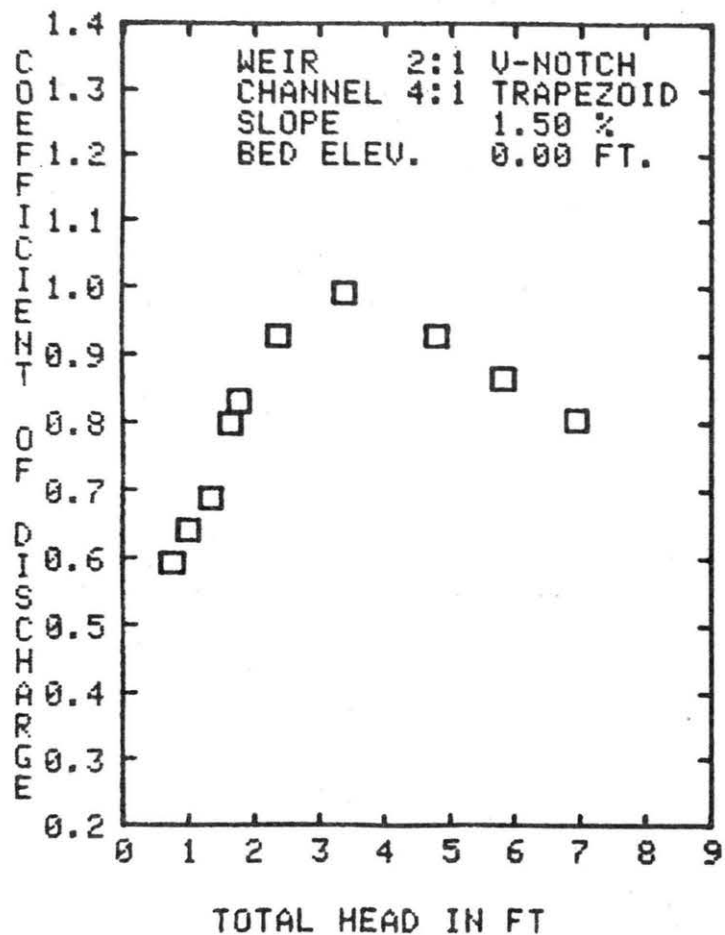

FIG. C-39

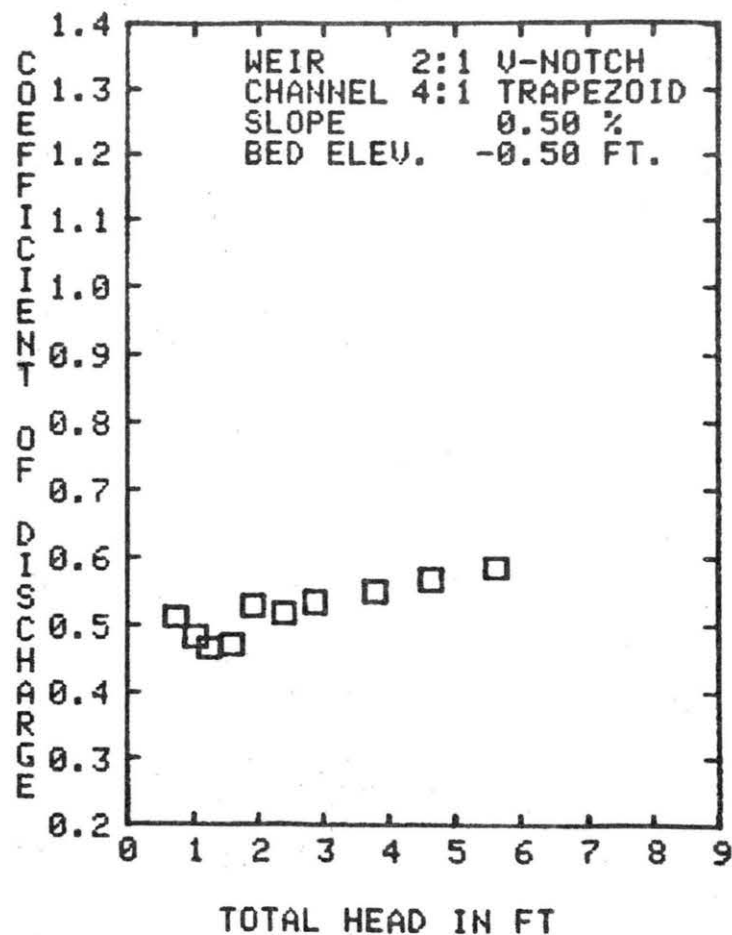
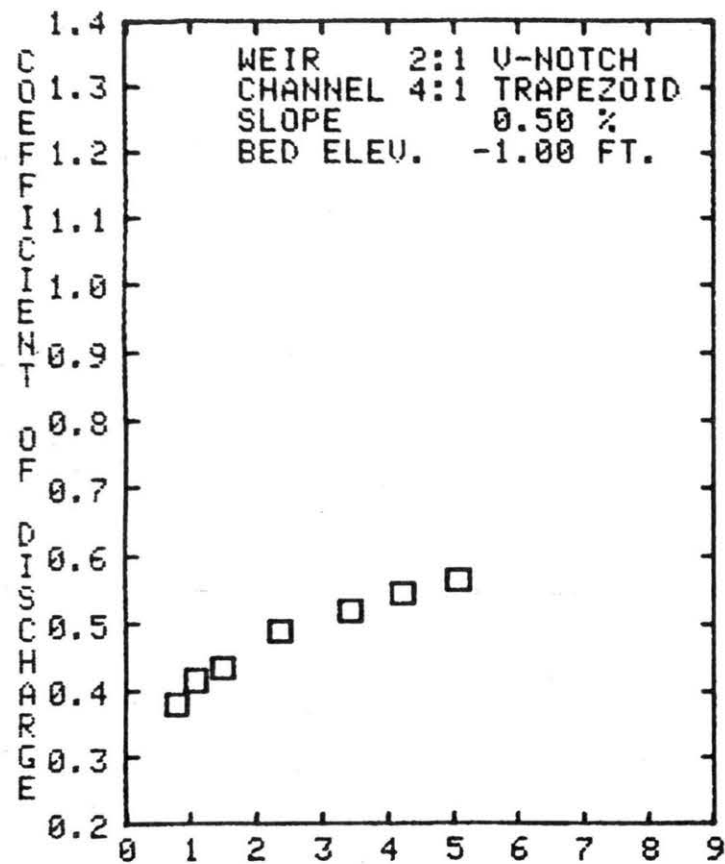

FIG. C-40

DISCHARGE COEFFICIENT CURVES, H_T VERSUS C_D



TOTAL HEAD IN FT

FIG. C-41

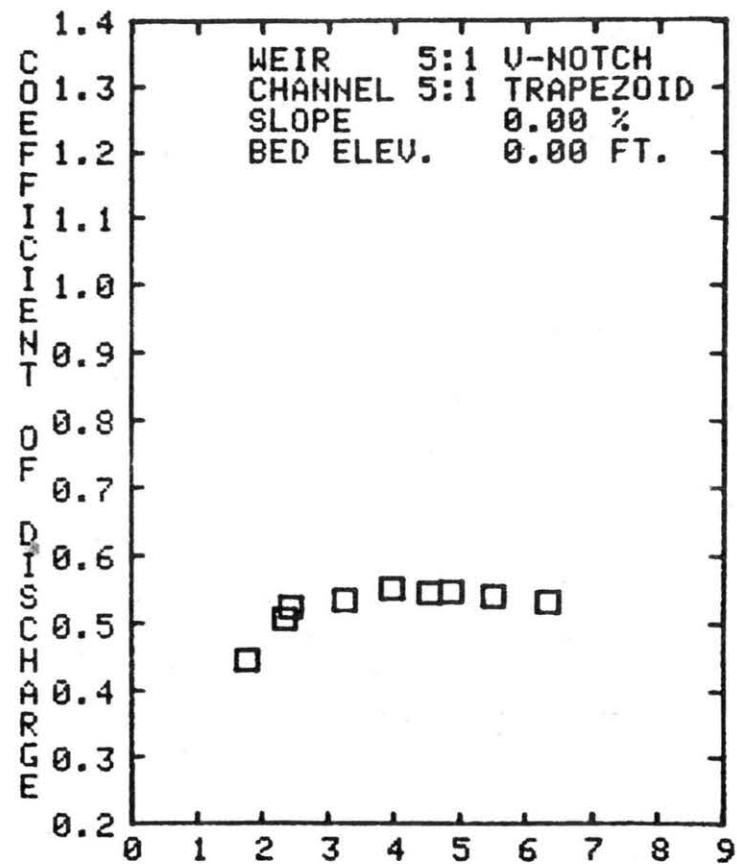

TOTAL HEAD IN FT

FIG. C-42

DISCHARGE COEFFICIENT CURVES, H_T VERSUS C_D

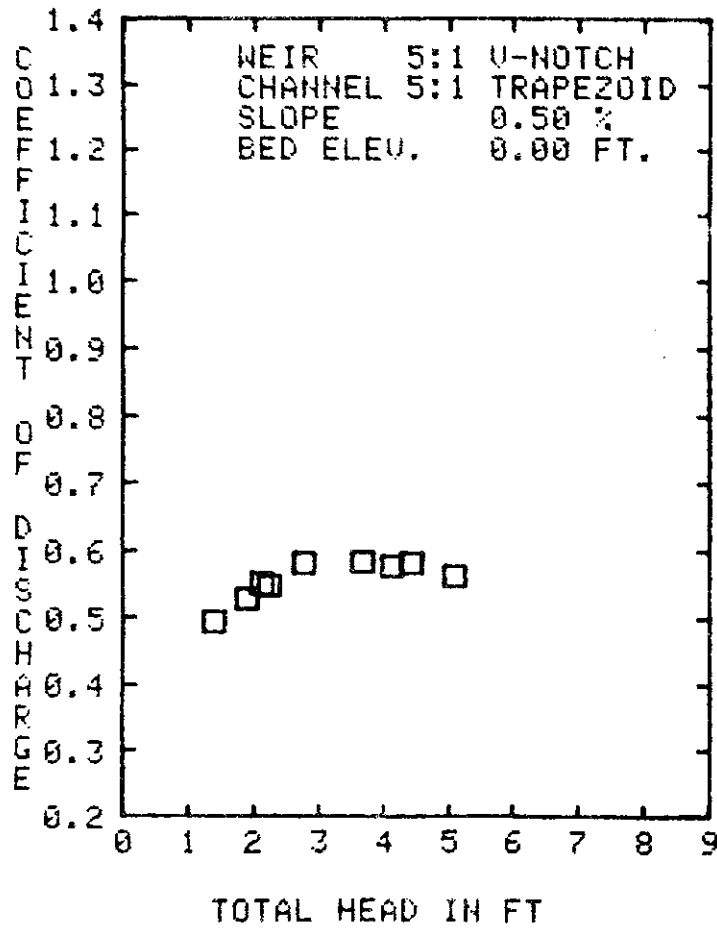

FIG. C-43

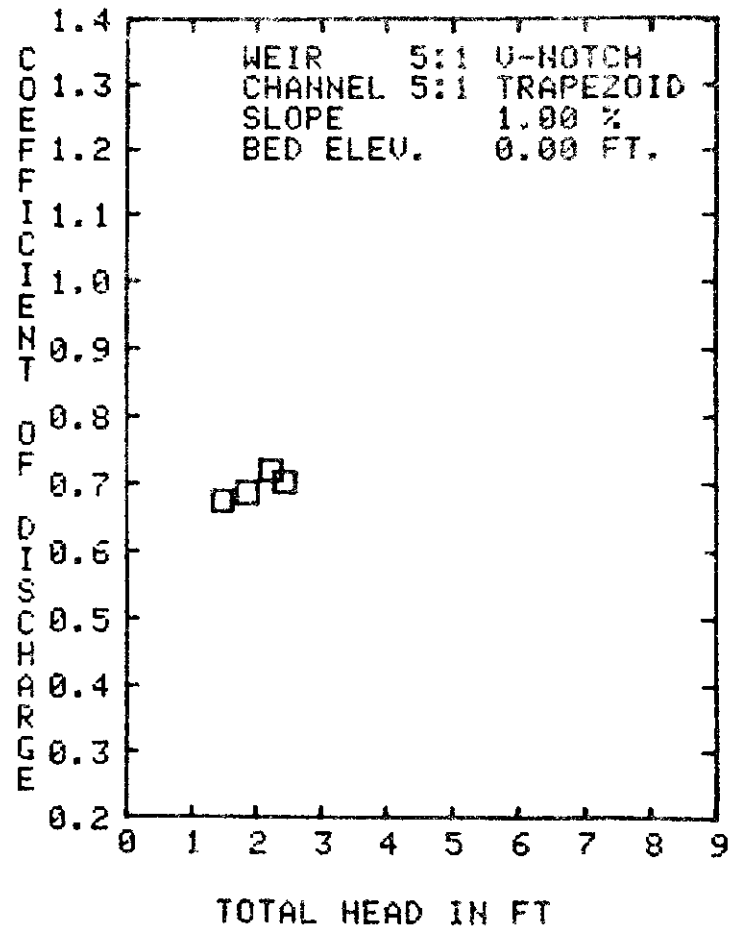
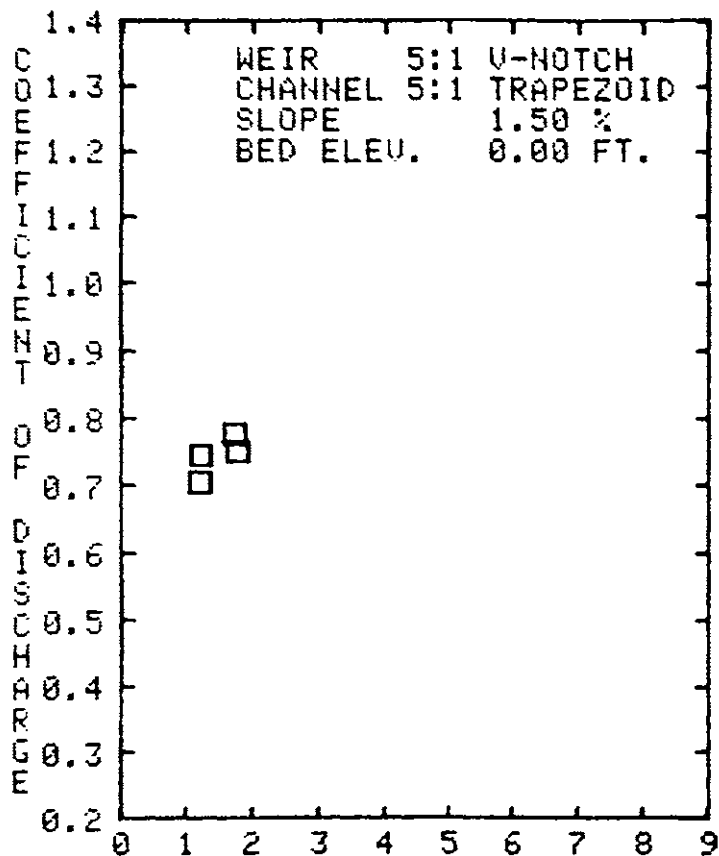

FIG. C-44

DISCHARGE COEFFICIENT CURVES, H_T VERSUS C_D



TOTAL HEAD IN FT

FIG. C-45

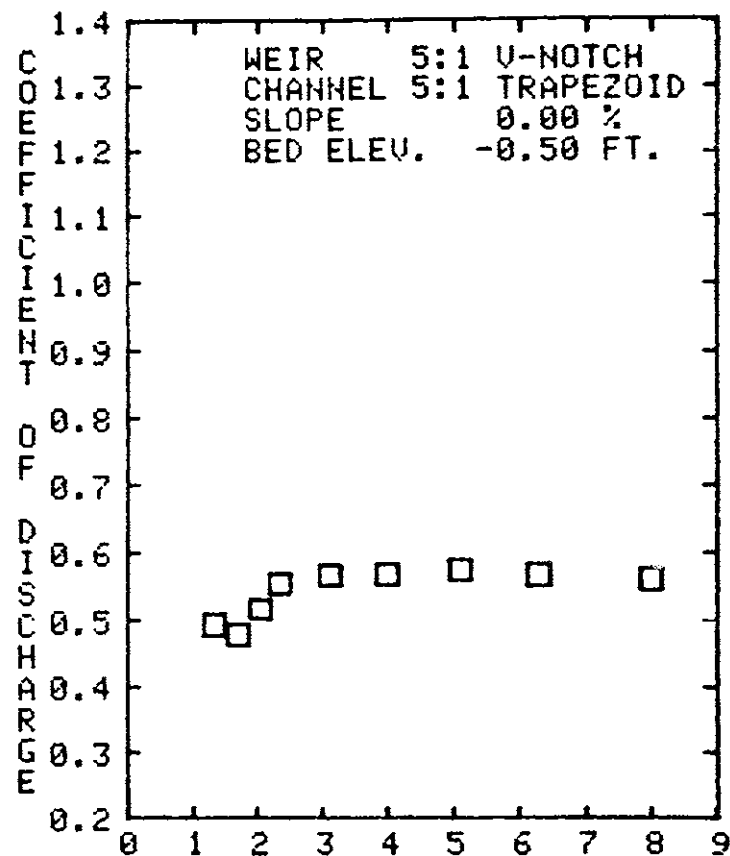

TOTAL HEAD IN FT

FIG. C-46

DISCHARGE COEFFICIENT CURVES, H_T VERSUS C_D

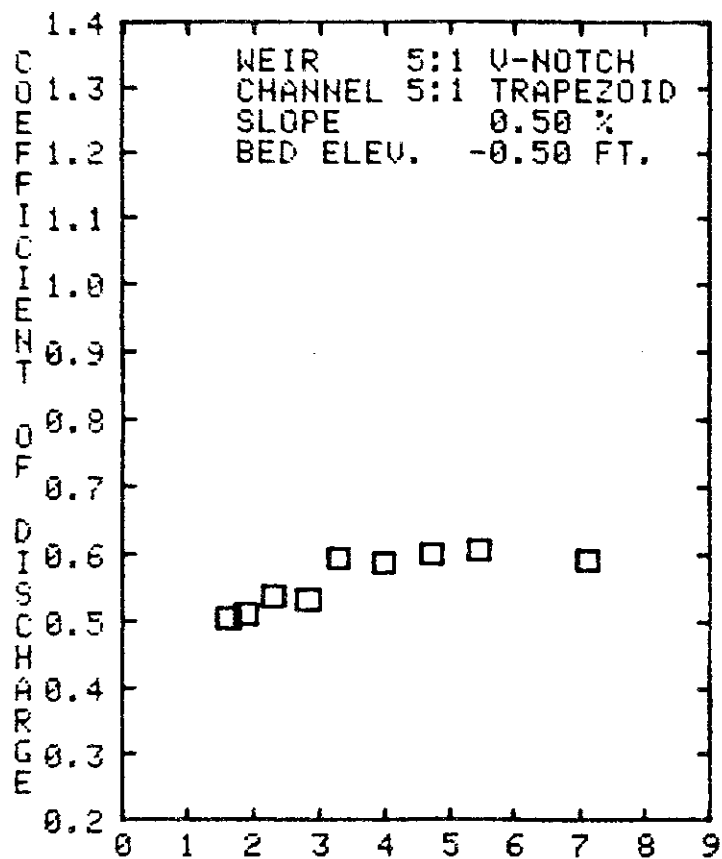

TOTAL HEAD IN FT

FIG. C-47

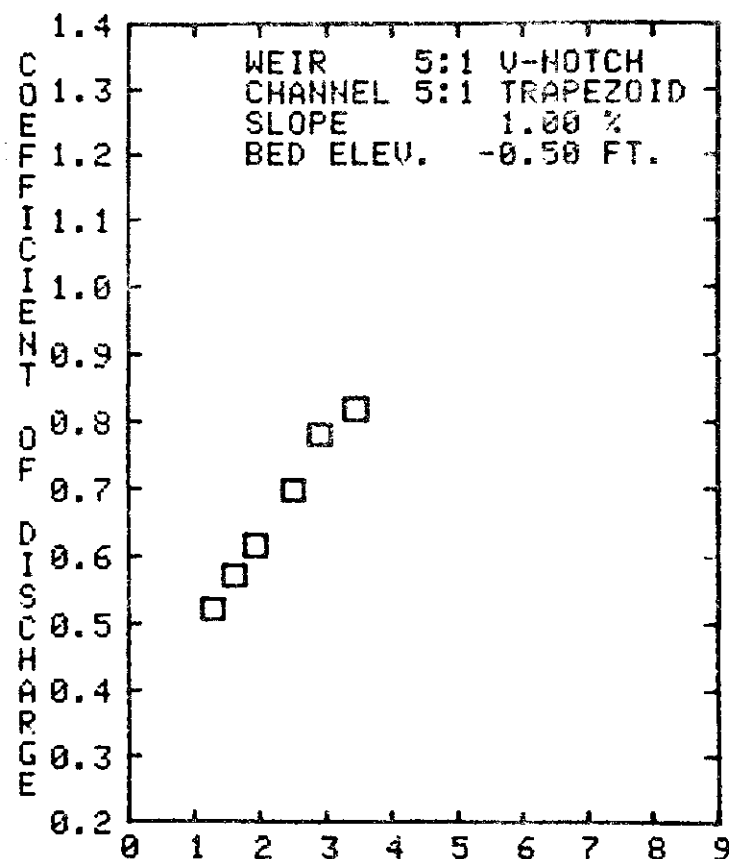

TOTAL HEAD IN FT

FIG. C-48

DISCHARGE COEFFICIENT CURVES, H_T VERSUS C_D

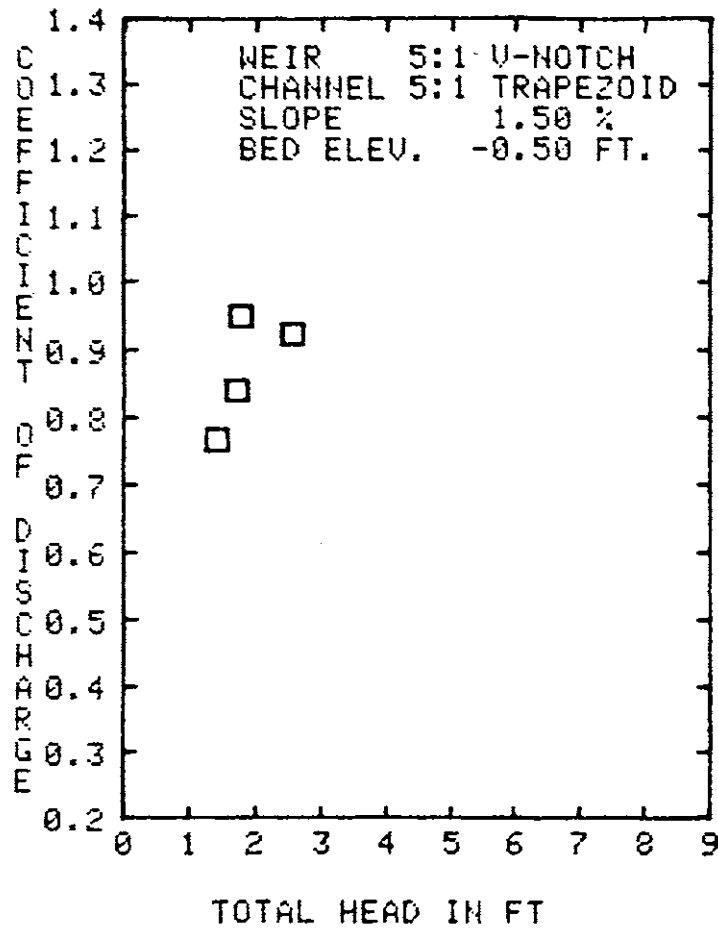

FIG. C-49

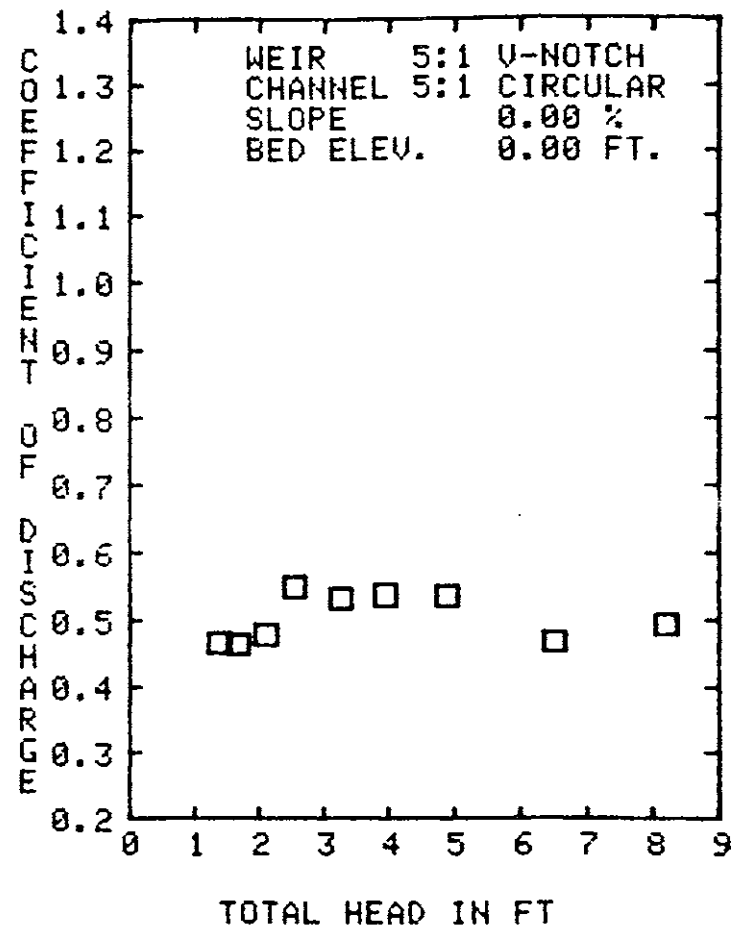

FIG. C-50

DISCHARGE COEFFICIENT CURVES, H_T VERSUS C_D

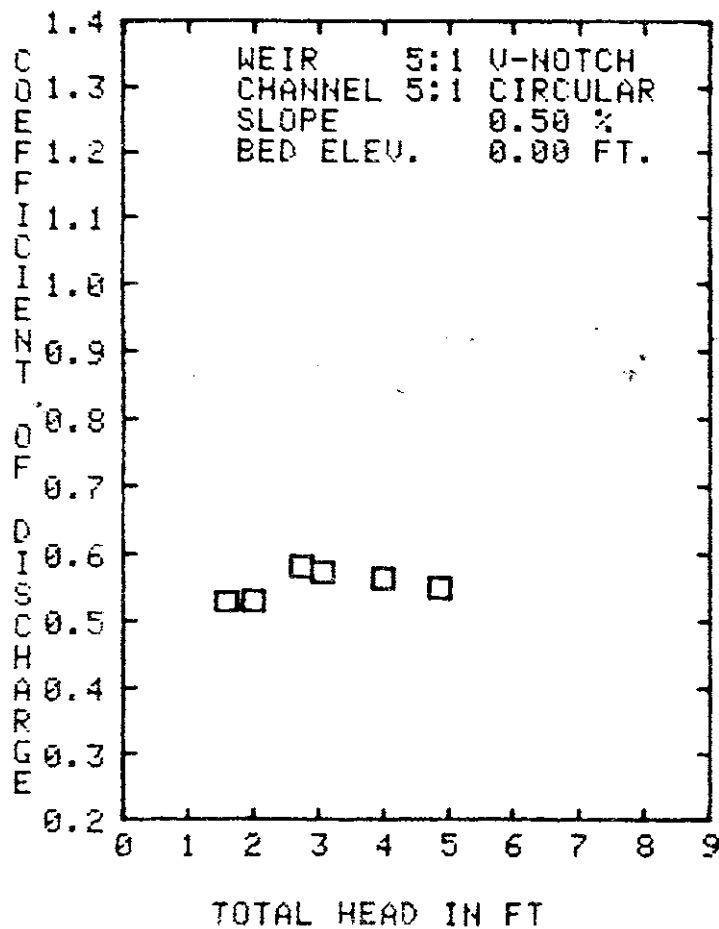

FIG. C-51

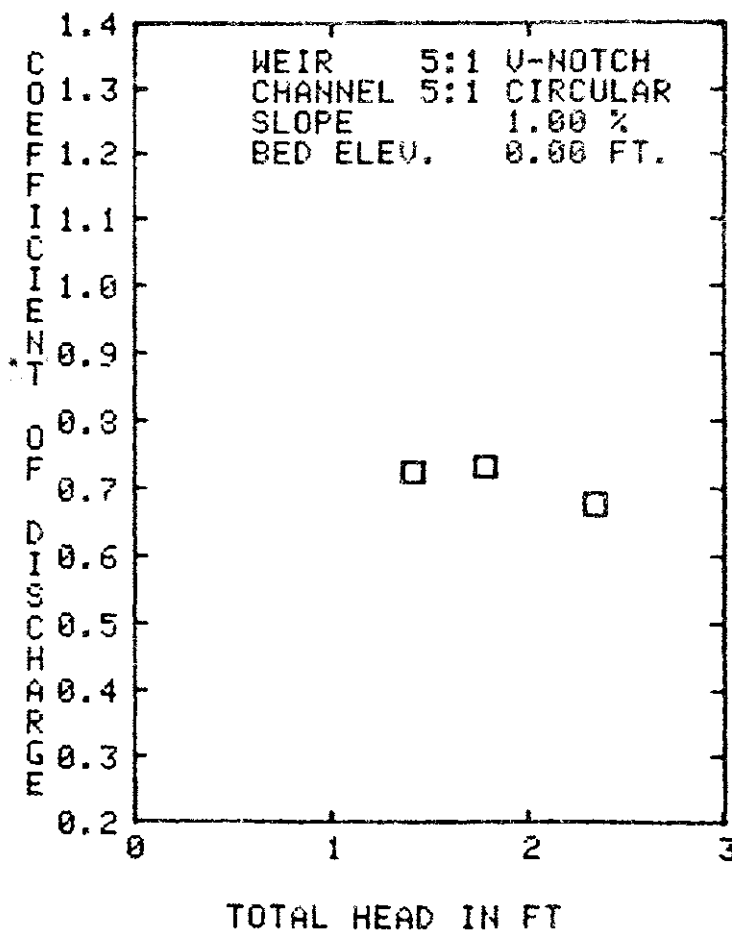
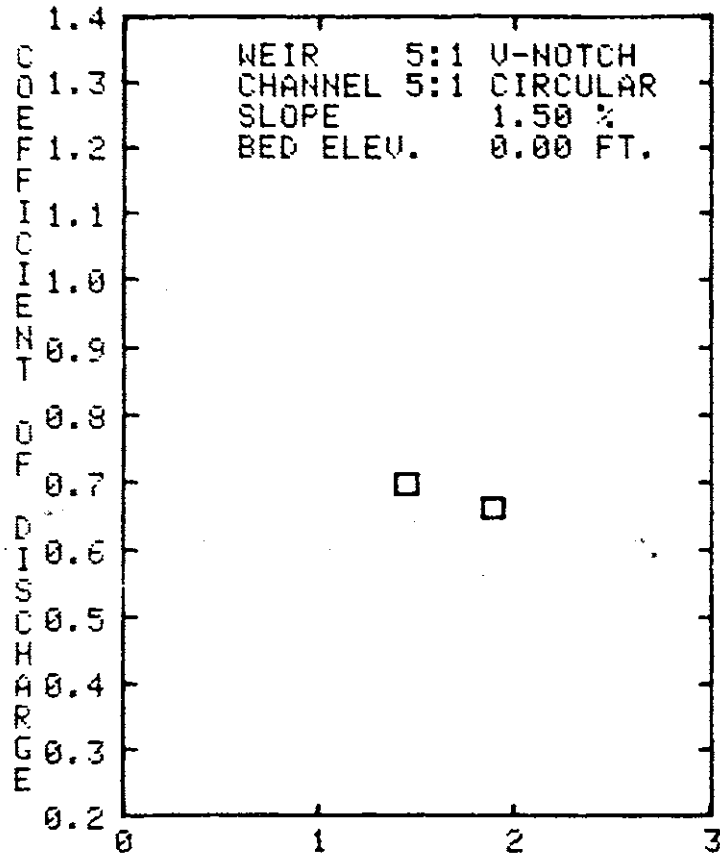

FIG. C-52

DISCHARGE COEFFICIENT CURVES, H_T VERSUS C_D



TOTAL HEAD IN FT

FIG. C-53

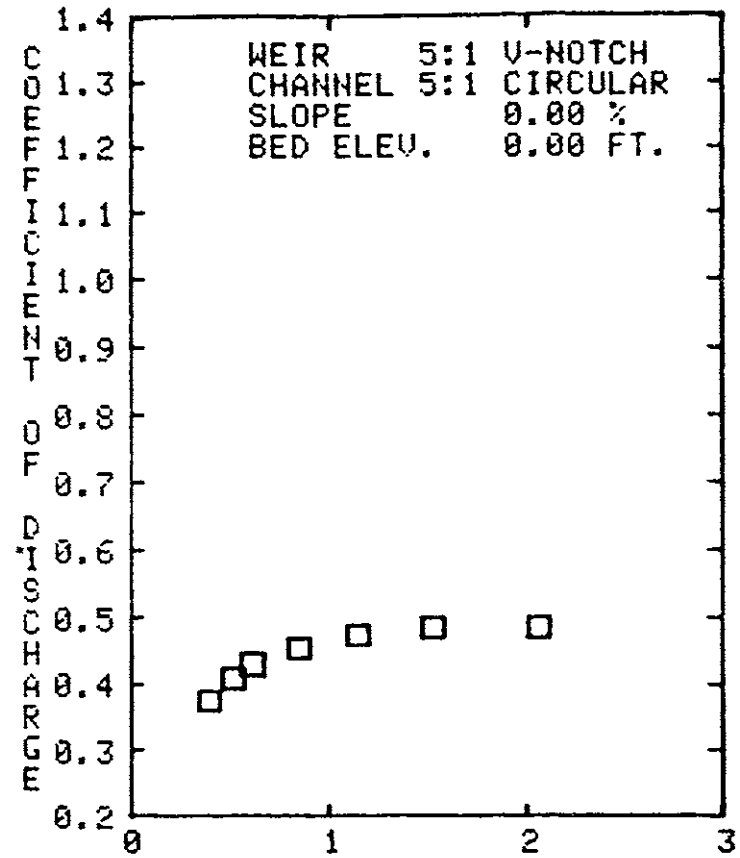

TOTAL HEAD IN FT

FIG. C-54

DISCHARGE COEFFICIENT CURVES, H_T VERSUS C_D

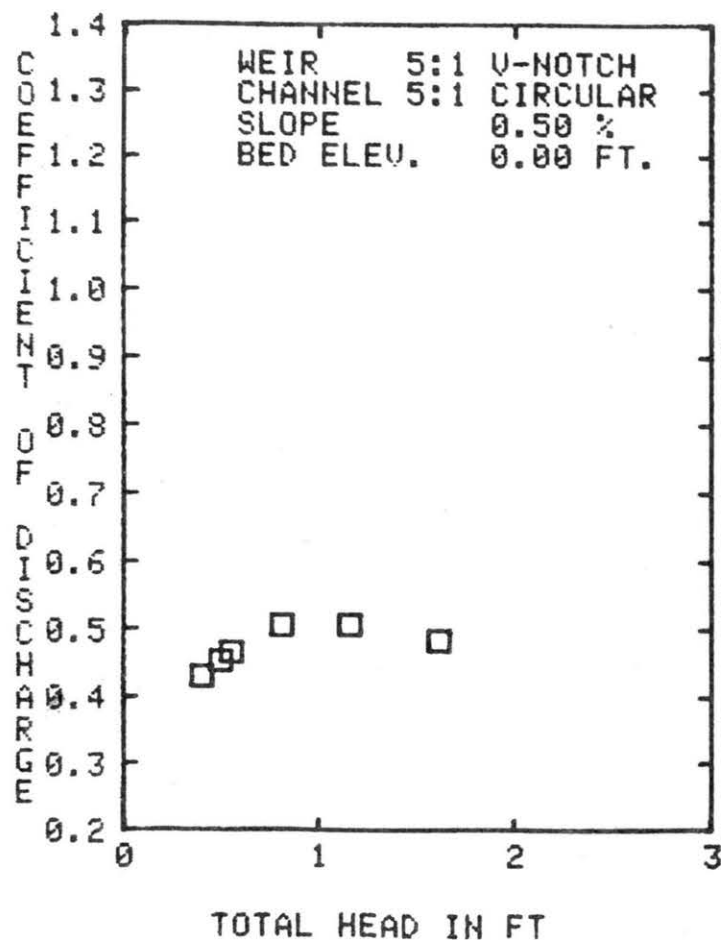

FIG. C-55

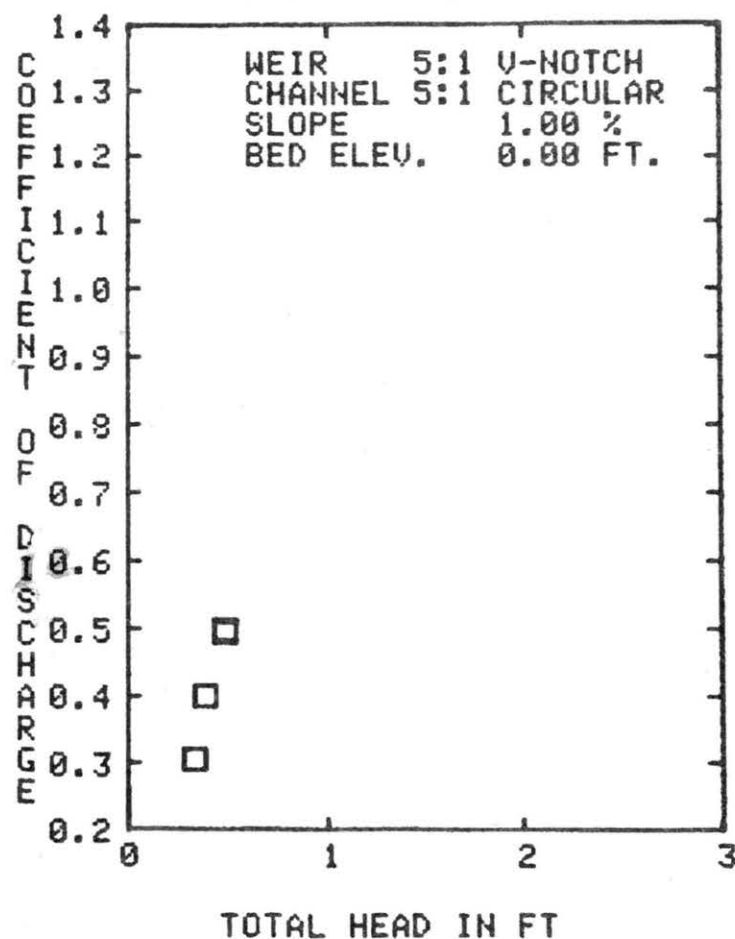
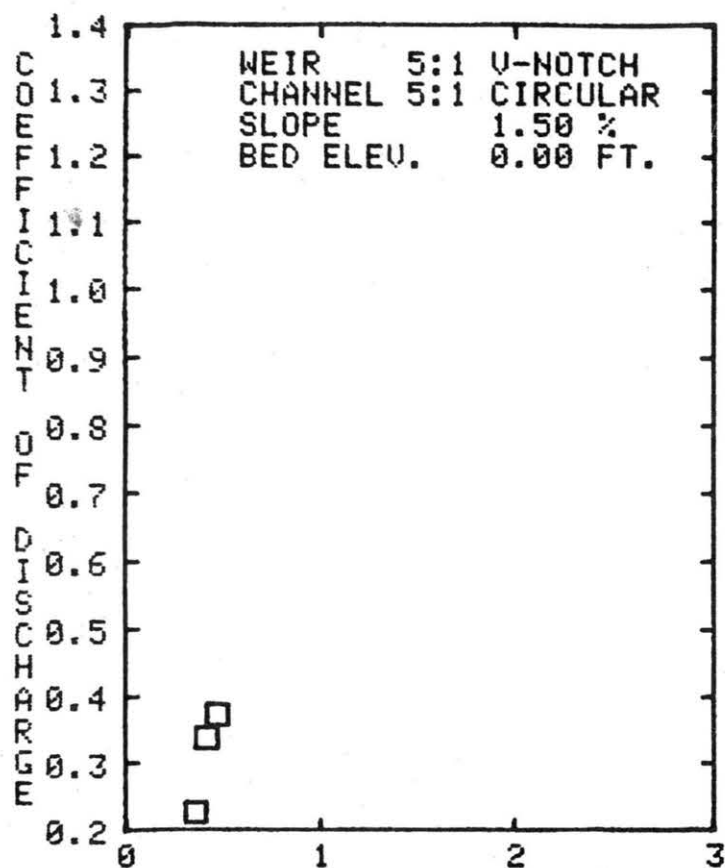

FIG. C-56

DISCHARGE COEFFICIENT CURVES, H_T VERSUS C_D



TOTAL HEAD IN FT

FIG. C-57

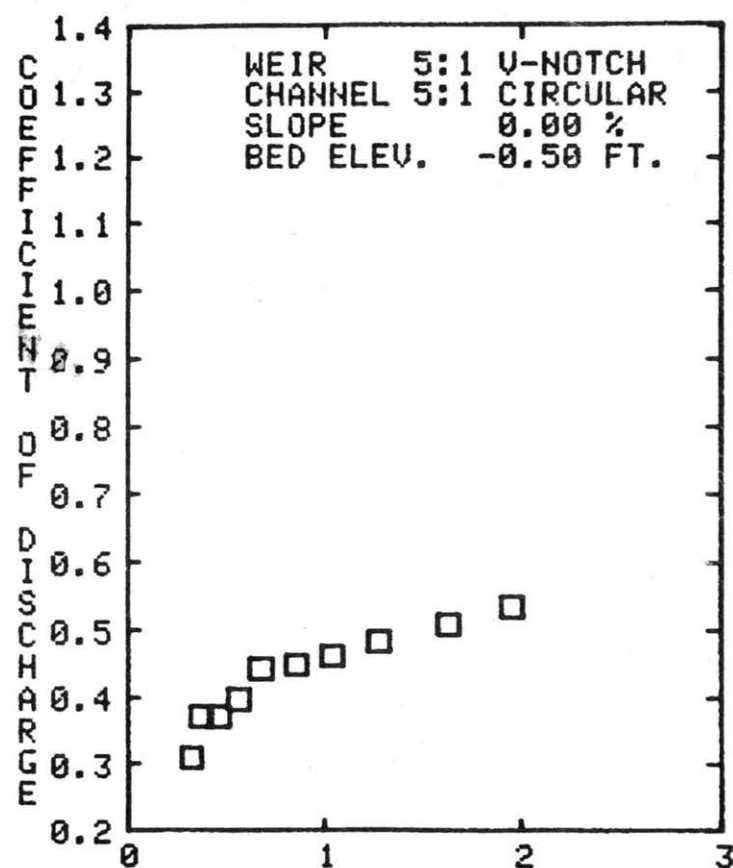

TOTAL HEAD IN FT

FIG. C-58

DISCHARGE COEFFICIENT CURVES, H_T VERSUS C_D

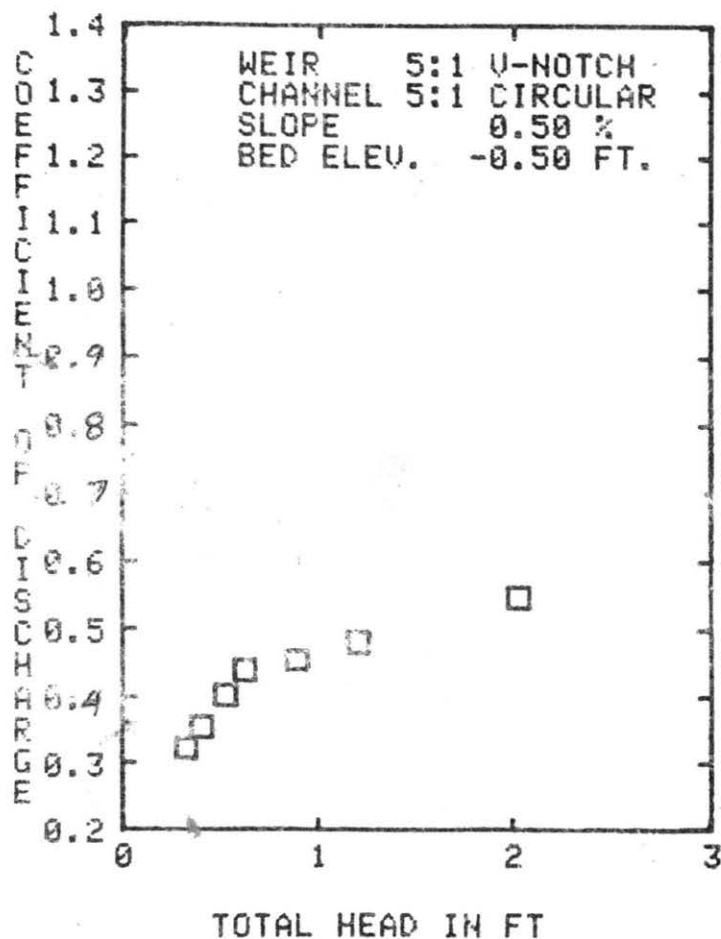

FIG. C-59

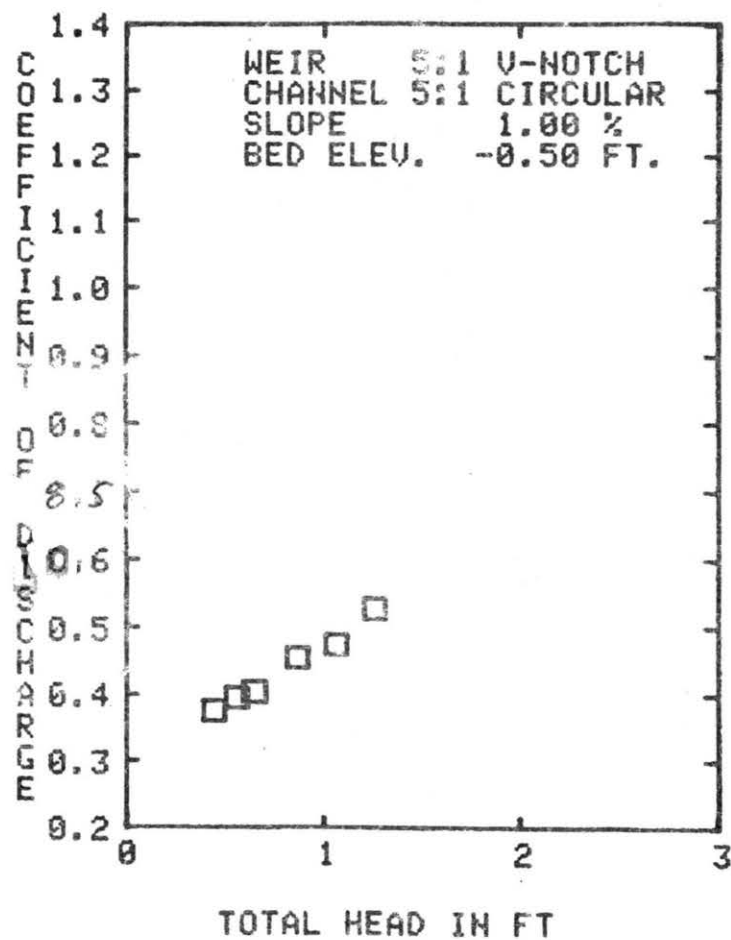

FIG. C-60